

PUBLIC DOCUMENTS
DEPOSITORY ITEM

AUG 30 1985

CLEMSON
LIBRARY

Bathhouse Row Adaptive Use Program

The Bathhouse Row Landscape: Technical Report

1

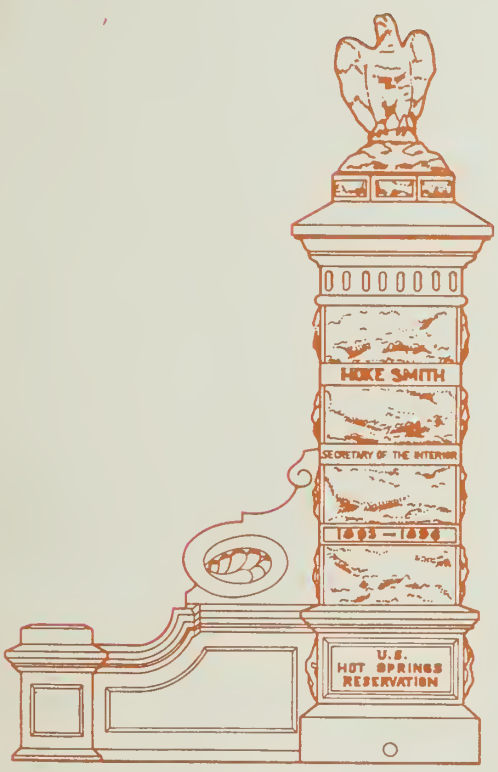

hot springs national park



Digitized by the Internet Archive
in 2012 with funding from
LYRASIS Members and Sloan Foundation

<http://www.archive.org/details/landscapemanagem00nati>

BATHHOUSE ROW ADAPTIVE USE PROGRAM
THE BATHHOUSE ROW LANDSCAPE: TECHNICAL REPORT 1

HOT SPRINGS NATIONAL PARK
Garland County, Arkansas

June 1985

CONTENTS

INTRODUCTION	1
HISTORICAL OVERVIEW	4-17
Early Use of the Hot Springs	4
Exploration and Early Settlement, 1800-1870	4
Emergence of the Spa and the Reservation, 1870-1892	5
Development of the Reservation, 1892-1900	6
Creation of the Premier American Spa, 1900-1922	9
The Reservation Becomes a National Park, 1922-1947	11
Decline of the Spa, 1947 to the Present	15
DESIGN AND DEVELOPMENT	18-32
Landscape Design Influences	18
Significant Landscape Developments	19
INVENTORY / EVALUATION	37-71
Analytical Process	37
Inventory	39-40
Identification of Landscape Subunits	39
Description of Landscape Subunits	40
Evaluation	64
Historical Integrity	64
Visual Accessibility	71
MANAGEMENT CLASSES	75
COMPATIBILITY ASSESSMENT	79-81
APPENDIX	82
SELECTED REFERENCES	101
LIST OF PREPARERS	102

MAPS

Bathhouse Row Area, 1985	3
Site Plan, Bathhouse Row, 1890s	23
Site Plan, Bathhouse Row, Early 1930s	33
Site Plan, Bathhouse Row, 1985	35
Landscape Subunits, Bathhouse Row Landscape, 1985	41
Historical Integrity, Bathhouse Row Landscape, 1985	69
Visual Accessibility, Bathhouse Row Landscape, 1985	73
Management Classes, Bathhouse Row Landscape, 1985	77
Spatial Organization and Functional Analysis, Bathhouse Row Landscape, 1890s	83
Spatial Organization and Functional Analysis, Bathhouse Row Landscape, early 1930s	85
Spatial Organization and Functional Analysis, Bathhouse Row Landscape, 1985	87

FIGURES

1. Artist's Composite Drawing of Bathhouse Row in 1888	7
2a. Sketch of Main Entrance, 1895	8
2b. Main Entrance, Looking toward Pavilion, ca. 1905	8
3. Arlington Lawn, 1943	11
4. Model of Cascade on the Grand Promenade, Arlington Lawn, ca. 1938	13
5. Grand Promenade Cut near Army and Navy Hospital, early 1930's	14
6. Display Spring behind the Maurice Bathhouse, date unknown	15
7. Main Entrance, 1984	16
8. Grand Promenade, Looking North, 1984	17
9. Construction of the Hot Springs Creek Arch, 1883-84	19
10. Central Avenue and Bathhouse Row, View Looking North, 1906	20
11. Grand Promenade, Looking North, 1984	20
12. Bathhouse Row, ca. 1894-95	21
13. Bathhouse Row, with South Park beyond, ca. 1896	22
14. Foreground Park, ca. 1914	25
15a. Tufa Fountain located in the Tufa Park, ca. 1913-1914	25
15b. Trail through Tufa Park, ca. 1913-1914	26
16. Superintendent's Residence, Fountain Street, ca. 1906	26
17. Foreground Park, Bandstand, before 1914	27
18. The Hoke Smith Fountain, date unknown	28
19. The Noble Fountain, late 1890's	28
20. Stevens Spring, date unknown	29
21. Alum Spring and Pavilion, date unknown	29
22. Upper Terrace on Hot Springs Mountain, Looking Northeast at Informal Plantings, 1898	30
23. Stone Culvert on Hot Springs Mountain, date unknown	31
24. Bathhouse Row and Upper Terrace with Promenade Grading Completed, ca. 1937	32
25. Lawn Park, Looking North, 1970's	32
26. Lawn Park, (including Arlington and Bathhouse Lawns) and the Foreground Park behind Bathhouse, Looking South, 1984	39

27.	Focal Landscape Composition Sketch	45	
28.	Magnolia Promenade Subunit, Looking North, 1984	45	
29.	Magnolia Promenade Subunit, Looking South, 1984	45	
30.	Feature Landscape Composition Sketch	47	
31.	Bathhouse Lawns Subunit, Looking at Quapaw Bathhouse Facade, 1984	47	
32.	Bathhouse Lawns Subunit, Looking North, 1984	47	
33.	Focal Landscape Composition Sketch with Feature	49	
34.	Main Entrance Subunit, Looking toward Central Avenue, 1984	49	
35.	Main Entrance Subunit, Looking toward Stevens Balustrade and Grand Promenade, 1984	49	
36.	Enclosed Landscape Composition Sketch	51	
37.	Arlington Lawn Subunit, Looking South along Bathhouse Row, 1984	51	
38.	Arlington Lawn Subunit, Looking Southwest toward Central Avenue, 1984	51	
39.	Display Springs Subunit, Looking at Seating Area, 1984	53	
40.	Display Springs Subunit, Looking at Display Pool, 1984	53	
41.	Maurice Display Springs Subunit, Looking from Magnolia Promenade, 1984	55	
42.	Maurice Display Springs Subunit, Looking Down from Maurice Bathhouse, 1984	55	
43.	Transition Area Subunit, Area behind Buckstaff Bathhouse, 1984	57	
44.	Transition Area Subunit, Area behind Ozark Bathhouse, 1984	57	
45.	Focal Landscape Composition Sketch	59	
46.	Grand Promenade Subunit, Looking North at Point where Main Entrance Ties into Promenade, date unknown	59	
47.	Grand Promenade Subunit, Looking North along Long Axis of Promenade, 1984	59	
48.	Open Lawn Bays Subunit, 1984	61	
49.	Open Lawn Bays Subunit, Looking across Arlington Lawn at Open Bays from Arlington Hotel, 1984	61	
50.	Canopied Landscape Composition Sketch	63	
51.	Open Woods Subunit, Looking along Paved Trail, 1984	63	
52.	Open Woods Subunit, Looking along Unpaved Trail, 1984	63	

TABLES

1.	Historical Integrity / Evaluation Rating Criteria and Score	65
2.	Summary of Historic Integrity Scores and Classes by Landscape Subunit	67

CHARTS

Analytical Process	38
Contrast / Alteration Rating Process	80

INTRODUCTION

The National Park Service is proposing to offer vacant bathhouses within the Bathhouse Row historic district at Hot Springs National Park for adaptive use. The leasing of historic properties was authorized by Congress in 1980 by amending Section 111 of the National Historic Preservation Act. The National Park Service has established procedures for the program in "Leases and Exchanges of Historic Property" (36 CFR 18) and the "Historic Property Leasing Guideline" (NPS-38). Proposed uses that would provide accommodations, facilities, or services to a substantial number of park visitors would be accomplished through concession contracts under the authorities of the Concessions Policy Act of 1965.

The purpose of the adaptive use program at Hot Springs is to preserve the historic bathhouses through compatible use and maintenance of the buildings by private businesses or individuals. The National Park Service also intends that such use will help restore the traditional levels of visitor activity along Bathhouse Row to maintain the historic scene and to contribute to the revitalization of downtown Hot Springs. Additional information on the park, Bathhouse Row, and National Park Service management proposals for the area is contained in the draft General Management Plan/Development Concept Plan which is available at the address below. The layout of Bathhouse Row is shown on the Bathhouse Row Area, 1985, map.

This report is number one in a series of seven technical reports (listed below) prepared by the NPS Denver Service Center to provide technical information for use in the development of proposals by prospective lessees or concessioners and in the evaluation of proposals by the National Park Service. The reports describe the Bathhouse Row landscape and structures and provide detailed information on historical development, present conditions, and significance of the landscape and each vacant bathhouse.

Bathhouse Row Adaptive Use Program Technical Report Series

The Bathhouse Row Landscape: Technical Report 1

The Superior Bathhouse: Technical Report 2

The Hale Bathhouse: Technical Report 3

The Maurice Bathhouse: Technical Report 4

The Fordyce Bathhouse: Technical Report 5

The Quapaw Bathhouse: Technical Report 6

The Ozark Bathhouse: Technical Report 7

This technical report on the Bathhouse Row landscape is organized into five sections that are intended to serve the following several purposes:

1. Historical Overview

To provide a historical context which traces the evolution of the bathhouses and landscape.

2. Design and Development

To describe significant landscape development periods, design philosophies, and constructed features.

3. Inventory/Evaluation

To describe the significant spaces (subunits), spatial character, function, and architectural elements of the present landscape and to evaluate the significance of the landscape in terms of historical integrity by comparing past development periods with present conditions and then identifying differences.

4. Management Classes

To develop management classes which describe the various degrees of modification allowed to the basic elements (spatial structure and character, function, and architectural elements) of the landscape units.

5. Compatibility Assessment

To provide a method for evaluating and mitigating possible modifications to the landscape as a result of adaptive use of the bathhouses, construction activities, or other management actions.

For additional information on the Bathhouse Row Adaptive Use Program, please contact the following individuals:

Historic Property Leasing Coordinator
Southwest Regional Office
P.O. Box 728
Santa Fe, New Mexico 87501
(505) 988-6385

Superintendent
Hot Springs National Park
P.O. Box 1860
Hot Springs, Arkansas 71901-1860
(501) 624-3383

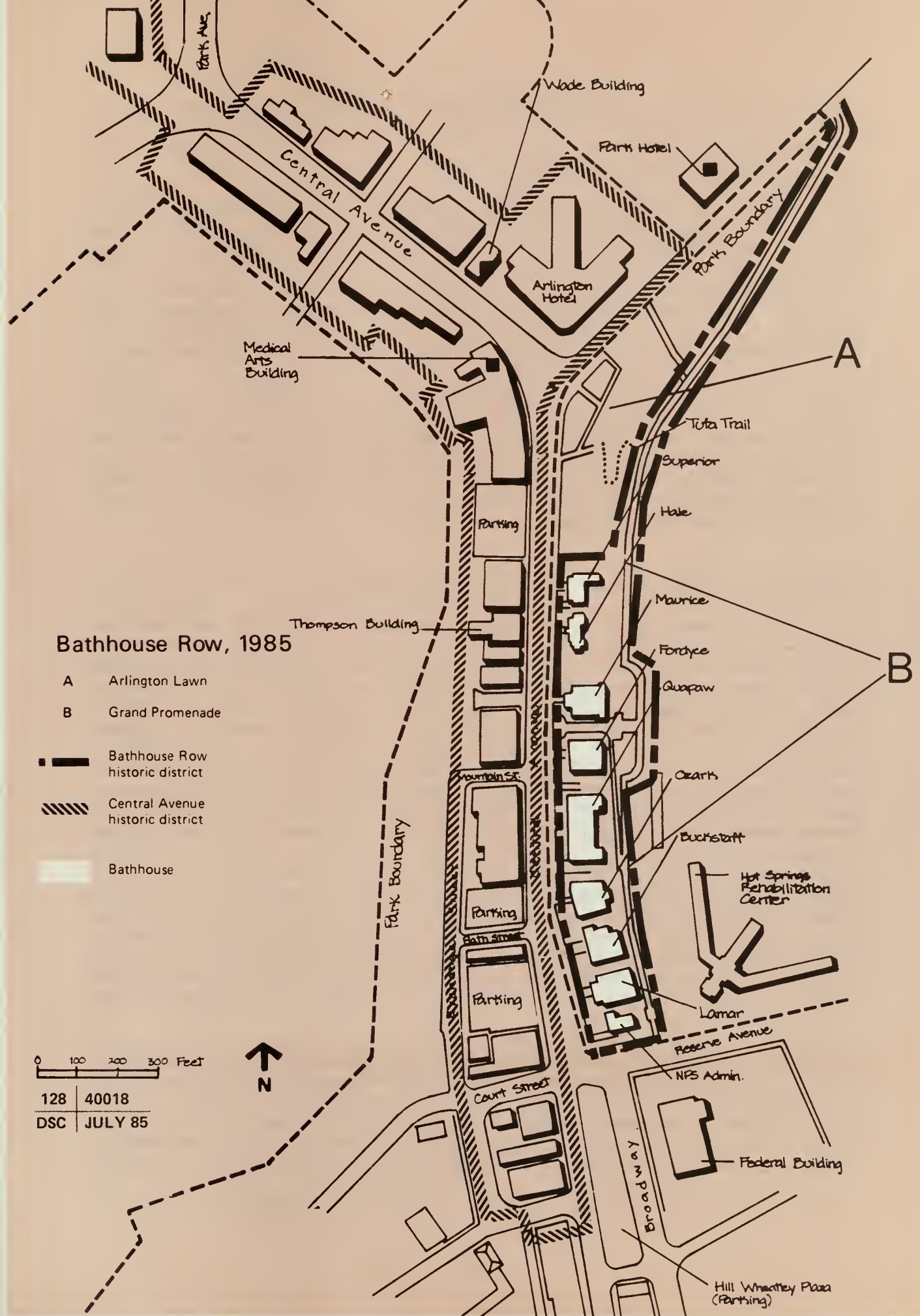

Bathhouse Row, 1985

- A Arlington Lawn
- B Grand Promenade

- Bathhouse Row historic district
- Central Avenue historic district
- Bathhouse

0 100 200 300 Feet



128 | 40018
DSC | JULY 85

- A Arlington Lawn
- B Grand Promenade

- Bathhouse Row historic district
- Central Avenue historic district
- Bathhouse

0 100 200 300 Feet



128 | 40018
DSC | JULY 85

Bathhouse Row, 1985

- A Arlington Lawn
- B Grand Promenade

- Bathhouse Row historic district
- Central Avenue historic district
- Bathhouse

0 100 200 300 Feet



128 | 40018
DSC | JULY 85

HISTORICAL OVERVIEW

EARLY USE OF THE HOT SPRINGS

Early human use of the area now included in Hot Springs National Park is known to extend back in history nearly 10,000 years. The broad Ouachita River Valley provided wood, water, fertile maize fields, and abundant game for Indian subsistence needs; burial mounds and remnants of early villages are scattered along Hot Springs Creek downstream from the park. Prehistoric use had little impact on the Hot Springs Creek Valley, consisting primarily of agriculture, bathing in the hot springs, and gathering stone for tools from the adjacent novaculite formations.

The "valley of the vapors" was probably visited first by European explorers in 1541 when Hernando De Soto and his men camped in the area. The first recorded European settlement in the area occurred in the late 1700s when trappers and traders built rude cabins near the springs for shelter while hunting and bathing. These early visitors, or perhaps the Indians using the area, also shaped basins in the tufa rock and built sweat lodges over the springs.

EXPLORATION AND EARLY SETTLEMENT, 1800-1870

The first detailed description of the hot springs and the surrounding landscape was provided by William Dunbar and George Hunter who explored the area in 1804. As described in their report, the hot springs lay in a narrow portion of the Hot Springs Creek Valley, at the western base of Hot Springs Mountain. The low surrounding mountains, part of the Zig Zag Mountains of the Ouachita Range, were covered by a variety of trees, flowering shrubs, and vines typical of a temperate climatic zone. Overhanging the creek were steep, rounded deposits of tufa rock, formed by the minerals precipitated from the hot water that cascaded down over the slope into the creek. The springs and tufa outcrops were concentrated along about 1,200 feet of the southwestern flank of Hot Springs Mountain.

Shortly after the beginning of the 19th century, emigrants from Louisiana began to settle around the hot springs, serving the adventuresome and the sick who came to bathe. Cabins provided public lodging until about 1820 when a double log cabin was put up to serve as a hotel. This hostelry was soon followed by a grist mill, larger hotels, and crude bathing houses built over and near the springs at the base of Hot Springs Mountain.

Following the highly publicized visits to the area by Dunbar and Hunter in 1804 and Major Stephen Long in 1820, the hot springs and surrounding land were legally reserved for public use by Congress in 1832. This reservation--the earliest Federal act to protect the natural environment for use of all citizens--is a significant milestone in U.S. conservation history, predating creation of national parks by almost half a century.

Despite the Act of Congress to reserve the springs, the area developed quickly. By 1860 the tiny settlement had grown to a respectable-sized village with a number of hotels and bathhouses built around and over the springs to serve the many visitors who came into the valley by stagecoach. Although most of the city's buildings were burned by raiders during the Civil War, its former inhabitants returned after the war to rebuild the town whose population was swelled by the sick and wounded war veterans who had come to bathe at the springs.

EMERGENCE OF THE SPA AND THE RESERVATION, 1870-1892

By the 1870s the area was rapidly becoming a spa resort, with bathing houses, fashionable hotels, and a variety of entertainments. Built mostly on Reservation land, these buildings stretched in a linear pattern along the creek. Ownership of the various valley lots, especially those around the springs, had been under litigation for nearly three decades when a Supreme Court decision of 1876 finally affirmed government ownership and control over the hot springs. The principal litigants--the Belding heirs, Albert Gaines, Governor Rector, and John Hale--later became some of the primary stock holders in bathhouse leases granted on the Reservation.

The Hot Springs Commission was appointed in 1877 to deal with the problems created by conflicting land claims and the various squatter developments. The Commissioners surveyed and formally laid out the town of Hot Springs, adjudicated claims, condemned buildings on the Reservation, sold unneeded lots, and outlined the basic shape of the landscape as we know it today. An 1878 fire burned many of the buildings the Commissioners had slated for removal from the Reservation, leaving only the Arlington Hotel and a few bathhouses in the area adjacent to the springs.

In 1877 General B. F. Kelley had been appointed Superintendent by the Secretary of the Interior to take charge of the permanent Reservation. Kelley cleared out the transients who had squatted on the mountainside and around the springs; built a carriage road to the top of Hot Springs Mountain; began maintenance of the extensive Reservation grounds; actively administered the bathhouse leases; and regulated the bathing industry. Under Kelley's direction, the first Government Free Bathhouse was built in 1877 over the "mud-hole" springs using private funds collected from visitors. This altruistic venture, sanctioned by the 1832 legislation, provided free bathing for indigents for over a century and contributed to the recognition of Hot Springs as America's great national health sanitarium.

Various Secretaries of the Interior took a great deal of interest in development of the Reservation. From the beginning they shared a vision of the area as a spa resort set in a beautiful mountain park with carriage drives, walking paths, summit overlooks, and seats for resting bathers. Part of this vision was the perceived need to repair the damage caused by earlier development and to impose order upon the wild mountainside by creating a "park". Downed trees and underbrush were burned to clean the mountainside, and hundreds of new trees planted to control soil erosion and to replace the stands of oak and pine decimated by squatters.

The lower portion of the mountainside along the creek, eventually to be known as Bathhouse Row, was also the subject of repeated development efforts over the years.

In 1884 Hot Springs Creek was walled over with a rock masonry arch culvert and Valley Street was covered; two years later a sewer line was built to service the city and the Reservation. These changes not only improved sanitation (the creek had been used as open sewer), but provided level topography for the construction of Central Avenue and new bathhouses, and for development of a formal landscape along the front of the bathhouses.

By 1892, the area in front of the bathhouses had been planted with some 300 small trees and a grass and clover lawn. Poplars lined the gravel path between the lawns and Central Avenue. A new generation of bathhouses had also been built to serve the ever-increasing number of visitors, drawn not only by the bathing facilities but by the now-popular social circuit. By 1891, the following structures were present on Bathhouse Row (shown in figure 1, north to south): the Arlington Hotel (built in the 1870s and expanded to cover the Little Rector site by 1885); the Rector (built prior to 1883, reconstructed by 1891); the new brick Superior (1889); the Hale (1879); the Independent (rebuilt as the Maurice in the 1890s); the Palace (1878); the Horseshoe and the Magnesia (late 1880s); the Ozark and the Rammelsberg (built prior to 1883); and the Lamar (before 1890). The Rix and Barnes site, facing Reserve Avenue, was vacant until 1893 when the Imperial Bathhouse was built. The Government Free Bathhouse (rebuilt in the early 1890s) was directly above and behind the Horseshoe and the Magnesia Bathhouses; the government pumphouse and reservoir occupied the far southwestern corner of Bathhouse Row. The imposing Army and Navy Hospital stood well above Bathhouse Row on the south end of the Reservation.

Bathhouses continued using the antiquated system of individual cooling tanks and mazes of above-ground pipes and wooden troughs strung across the mountainside. Though most of the springs had been covered over, their deteriorated masonry and decrepit wooden covers provided little protection against contamination.

DEVELOPMENT OF THE RESERVATION, 1892-1900

Between 1892 and 1900, a massive improvement and beautification program was undertaken for the Hot Springs Reservation. Secretary of the Interior John Noble selected a young Army engineer, Lieutenant Robert Stevens, to supervise the improvements. Secretary Noble had a number of ideas about the project. Foremost, improvements were to be made in a manner befitting this great "National Health Resort", and the natural mountainside scenery was to be heightened by a decorative park in the foreground. Bathhouse Row was to be transformed into a formal landscape containing walks, rests, drinking fountains, shrubbery, etc. The old surface network of pipes was to be removed, and the old wooden cooling tanks replaced by more decorative ones. The foreground area just above the bathhouses was to be made into a natural park with walks, rests and summer houses. Winding roads and walks of a gentle grade for use by invalids were to lead to the summit of the mountain.



Figure 1. Artist's Composite Drawing of Bathhouse Row in 1888



Figure 2a. Sketch of Main Entrance, 1895
(Source: Hot Springs National Park)



Figure 2b. Main Entrance, Looking toward Pavilion, ca. 1905
(Source: U.S.D.O.I., Report of the Superintendent)

Originally, Frederick Law Olmsted's landscape architecture firm was chosen to prepare a design for the development. Unfortunately, the project was repeatedly delayed, leaving crucial elements of the plan undone. The firm eventually proposed an ornate formal scheme including a Spanish-style stone arcade with an open timber roof, covering a broad, level public promenade along Bathhouse Row. The Olmsted plans were rejected by Secretary Noble who was afraid the arcade would create an artificial visual barrier between the Reservation and the city, would keep the sun off promenading bathers during the cooler months of the year, and would close off access to the bathhouses for supply purposes. Ultimately, virtually all of the design--except some retaining walls, parapets and selected portions of the main entrance--was done by Stevens under the Secretary's general guidance.

By 1893 Robert Stevens had completed topographic surveys and a formal landscape plan which was approved by the Secretary. Stevens then supervised the implementation of his plan, much of which was constructed by 1900. Stevens' excellent sense of proportion, design, and balance are reflected in the conceptual landscape setting he helped to create for Hot Springs--a legacy that is still evident today. A more detailed analysis of the Stevens plan is found in the next section.

CREATION OF THE PREMIER AMERICAN SPA, 1900-1922

Despite the extensive improvements of the 1890s, the Hot Springs bathing facilities suddenly looked shabby, dirty, and inadequate at the turn of the century. Americans were gradually becoming more aware of the bacterial theory of illness and raised objections to the poor bathing conditions. Although the individual bathhouses were overcrowded by the increasing numbers of visitors, the owners provided little but cosmetic repairs to the old structures and equipment. Visitors increasingly expected the government to provide better facilities, updated equipment, trained attendants, proper sanitation, and good medical direction. All of these factors prompted the Department to make a number of policy changes and improvements over the next few years.

In 1910, following an inspection of the bathhouses which revealed filthy conditions and antiquated equipment, the Secretary outlined a new Departmental policy: there were to be no lease renewals for the individual bathhouses unless the applicants agreed to build new, sanitary, modern buildings which included all the essential, up-to-date equipment. No upper limit was put on bathhouse cost, but it was generally accepted that the new bathhouses would be large and luxurious; the most modern heating, plumbing, and ventilation systems would be used; and the most technologically advanced equipment and modern furnishings would be installed. Since all of the bathhouse leases would expire between 1910 and 1920, this ruling affected all of Bathhouse Row.

In 1911, excess government lots were sold, netting nearly \$83,000 for Reservation improvements. In response to the push for sanitation and better facilities, additional reservoirs were built early in the century; the Government Free Bathhouse was remodeled; communal bathing pools were removed; and new cooling towers were installed. A dispensary and a

clinic were established on the second floor of the Free Bathhouse to serve the needy, and a Reservation medical director was appointed. Although each succeeding superintendent proposed increasingly elaborate plans for the Reservation, little work other than maintenance was actually done to the Bathhouse Row landscape before 1916.

To comply with Departmental policy, the bathhouses along the Row were systematically razed and most were replaced with new structures--first the Maurice in 1911, followed by the Imperial and the Buckstaff in 1912. The Hale Bathhouse, one of the newest and best-built of the older Victorian bathhouses, was extensively remodeled, reopening to the public in 1915. The Palace was removed and the new Fordyce rose in its stead in 1915. The new Superior opened in 1916; the Ozark, the Lamar, and the Quapaw opened in 1922. These new bathhouses were large, expensive and exquisitely appointed. Drawing heavily on European examples, they incorporated expanses of stained glass, paneling, and marble. Several springs discovered during construction of the bathhouses were kept as display springs in the bathhouse basements.

Encouraged by its success in Europe, the Reservation installed the Oertel Graduated Exercise Plan in 1914-15. This involved a self-guided booklet and marked trails and roads of graduated difficulty, providing walking and climbing exercise for all types of visitors. The mountainside walks, many built of tufa, were upgraded and landscaped, and new walkways were added to accommodate more numerous visitors.

With the creation of the National Park Service in 1916, administration of the Hot Springs Reservation became the responsibility of the new agency. Director Stephen Mather took a strong personal interest in the Reservation, urging beautification on an elaborate scale. Mather, wanting to surpass the European resorts, imported landscape architect Jens Jensen from Chicago to help lay out some of the plantings on the Reservation--in particular colorful raised beds composed of thousands of spring-flowering bulbs. Installation of electric lights along the promenade in front of the bathhouses added to its charm, and increased use of the new "White Way" into the evening hours.

Reservation superintendents and Departmental officials had been advocating development for Hot Springs since the early 1900s. Unfortunately, no general development plan had been written for the Reservation when the first of the new bathhouses was built, so much of the design was left to the individual lessees. The large new structures encroached upon the buffer space behind them and adjacent to the foreground area, closing in the space visually and overshadowing the 1890s entrances. Concerned that much of the work was being done without proper direction, the Department secured a \$10,000 appropriation and employed Little Rock architects George R. Mann and Eugene John Stern in 1917 to draft a comprehensive overall plan for the Reservation.

Mann and Stern visualized an entire row of bathhouses in the soon-to-be-popular Spanish Renaissance Revival style, set among formal concert and upper gardens with secluded space, massed shrubbery, vine-covered walls, and trees all around. The elaborate Mann and Stern scheme for the "Great American Spa" would have cost \$2 million, but was

postponed by World War I. Following the war, costs were boosted by inflation, materials were in short supply, and the proposal was shelved, never to be completed. However, Mann and Stern had a significant impact upon Bathhouse Row; they designed a number of the bathhouses and influenced features of others. Their comfort station design was used on Bathhouse Row in the 1920s and the comprehensive plan, on file at the park, influenced subsequent planning on a very subtle level.

THE RESERVATION BECOMES A NATIONAL PARK, 1922-1947

The Hot Springs Reservation was formally designated a national park in 1921. Over the next decade and a half, administrators slowly shifted their emphasis towards less formal landscaping, recreation, and conservation of natural resources.

Major landscape changes along Bathhouse Row were triggered when the Arlington Hotel burned in 1923. Numerous suggestions and site plans were presented by various groups for the now vacant area, noting its convenient location near the central business district and presuming an intense recreational use for the area. At the insistence of NPS Assistant Director Cammerer, however, the area was kept as an open, grassy expanse. Magnolias were planted along the new sidewalk, aligned with the promenade in front of the bathhouses. White gravel walkways were laid out across the open lawn, and trees and flowering shrubs were planted along the inside of the walk. In 1931, a law was passed to preserve the area for park and landscaping purposes and to forbid its leasing for bathhouses or other structures. The lawn soon began to be used by various local groups for assemblies, pageants, holiday programs, and special ceremonies--a use that continues today.



Figure 3. Arlington Lawn, 1943
(Source: Hot Springs National Park)

Other changes to Bathhouse Row during this period were generally limited to repair, replacement, or removal of various landscape features and structures. The "White Way" lighting system and the sewer system were renovated. Spurred by criticism of the forced rebuilding of the bathhouses along the Row, the Service finally removed the old Government Free Bathhouse and built a new, modern structure off Bathhouse Row in 1922.

To complete the renovations begun at the turn of the century, a new hot water collection system was finally constructed during the early 1930s. The centralized system included new reservoirs, piping, pumps, electrical equipment, meters, and manholes. This construction resulted in significant changes to the Bathhouse Row landscape. After being damaged by the heavy equipment, the Magnolia Promenade was redone and the adjacent curbs and gutters were replaced. A new lawn--complete with sprinkling system, shrubs, and trees--was installed on top of a reservoir constructed between the old pumphouse/office and the Imperial Bathhouse. Oak, pine, cedar, gum, and hickory trees were also planted in a random pattern over the other new reservoirs on the mountainside, and shrubbery was set in strategic areas to conceal the exposed manholes.

Other changes which occurred at Hot Springs after 1922 were the result of broader influences and philosophies. As part of the early New Deal programs, the National Park Service had created a number of city, county, and state parks and recreation areas as public works projects. The Service was also reorganized and a large number of disparate areas (battlefield sites, cemeteries, historic sites and monuments, etc.) were brought into the national park system by executive order.

Based largely on experience with the large western parks, Service officials had gradually developed a conceptual picture of the national park as an area to be preserved in its natural state, free from the inroads of modern civilization. Harold Ickes, appointed Secretary of the Interior in 1933, was concerned that parks had been over-developed in the past and supported the philosophy of keeping national parks in their natural state in the future.

By this time Hot Springs had been managed by the Service for over a decade, but for the first time, the superintendent was chosen from NPS ranks. Visitation patterns had begun to change some time earlier, spurred by the new Little Rock highway and auto camping. These trends were intensified by the Great Depression which saw thousands of people flock to Hot Springs to take advantage of the free auto camp, bathhouse, and clinic.

All of these changes combined to create an identity crisis for Hot Springs National Park. Despite the long history of federal ownership and the formal "park" designation, the developments at Hot Springs began to be viewed as part of the "non-park" category. These new concepts of a national park guided design of 1930s developments at Hot Springs and also influenced planning for the park for the next half century.

Early in the 1930s, a comprehensive general development plan was done for the entire park. The plan proposed formal development of the west slope of Hot Springs Mountain, including a hot water cascade and a new

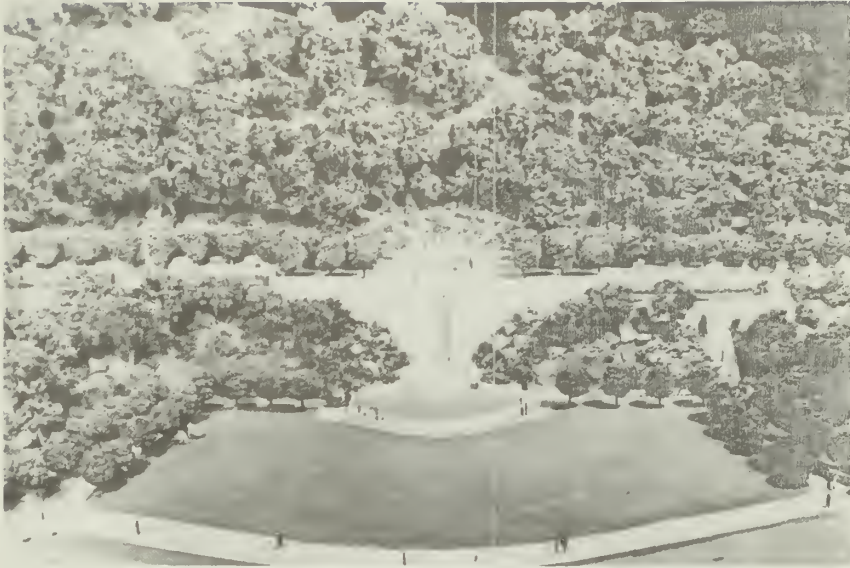

Figure 4. Model of Cascade on the Grand Promenade, Arlington Lawn, ca. 1938
(Source: Hot Springs National Park)

promenade with large entrances on either end. The greenhouse, the old superintendent's house, and ancillary structures on the northern end of the row were to be removed. The private property across Central Avenue west of Bathhouse Row was to be purchased and returned to natural conditions more appropriate to a national park. Park boundaries would be expanded to include the balance of the upper slopes of North, West, and Sugarloaf Mountains to give Hot Springs the space, character, and atmosphere of a "real national park." Due to the Depression, however, there were no funds available for land acquisition, so this part of the plan was postponed indefinitely.

Planning for development of the lower portion of Hot Springs Mountain immediately behind the bathhouses was turned over to designer Charles Peterson, then a junior landscape architect in the Service. Peterson's plan divided the area into two parts, each to be developed differently. The lower portion, the upper terrace and parks which extended from Reserve Avenue to Fountain Street, was to receive formal development, including construction of a "Grand Promenade," while the wooded slope above was to be helped back to its "natural" state as soon as possible. Bathhouse Row and the Magnolia Promenade were omitted from the plan.

Construction of the Grand Promenade was begun in the early 1930s, but despite repeated requests from the superintendent, funding for the promenade was omitted from the 1935 and 1936 programs. Although the alignment grading was virtually completed, the project was stopped. The Grand Promenade project had been hindered throughout the 1930s by numerous design changes and delays occasioned by a variety of engineering problems. It is also likely that the reorganization of the Service, the popular view of national parks as "natural" entities, and escalating costs heavily influenced the Director's decision to abort the project at this point.



Figure 5. Grand Promenade Cut near Army and Navy Hospital, early 1930's
(Source: Hot Springs National Park)

About this same time, an outspoken report critical of past park development policies was written by a Department of Agriculture employee, E. B. Meinecke. While proposing his own ideas for yet another massive park development program, Meinecke urged that measures be taken to divorce the park from the city and restore the natural forests and native flora. There are also numerous indications that Service personnel were concerned over the integrity of the area as a national park, and it is probable that this report created a stir among Service officials, helping to make the future of the Grand Promenade uncertain. Nevertheless, the Imperial Bathhouse was removed and the southern entry approach graded by 1938. Other promenade work during the latter part of the 1930s was confined to slope stabilization and planting, graveling of the walkway, and installation of temporary wooden steps and guard rails so the walkway could be used without further work.

A great deal of maintenance work was done along Bathhouse Row during the 1930s. A new sewer system was installed by the city of Hot Springs. The underground cable for the Bathhouse Row lighting system was replaced in 1938 and the overhead streetcar lines and the tracks on Central Avenue were removed about the same time. The main entrance columns, the Pagoda pavilion, and other architectural elements were sandblasted in the mid-1930s. The main entrance exedra walls and the fountains were removed and replaced by a curved row of shrubbery. The old pumphouse/administration building was razed in the mid-1930s, and the present administrative building was installed with office space, visitor center, and a museum. The landscape plan done for the new structure was correlated with the nearby promenade entrance design, and the building itself was designed to be compatible with the rest of Bathhouse Row.

Early in the period, it was proposed that a well, previously drilled in the area between the Fordyce and Quapaw Bathhouses, be used to supply water for an elaborate glass and iron fountain so visitors could see a

"natural" spring in action. After several months of debate and many different proposals, the idea of a formal fountain was dropped and designs were completed for a display pool between the Maurice and Fordyce Bathhouses. Two seeps were led together to run over small



Figure 6. Display Spring behind the Maurice Bathhouse, date unknown
(Source: Hot Springs National Park)

cascades of tufa masonry into a small pool and from there into the Hot Springs Creek arch. The temporary pool was to be removed when the promenade was completed, but became so popular with the public that new walks had to be installed to accommodate the crowds. It is still a Bathhouse Row attraction today.

DECLINE OF THE SPA, 1947 TO THE PRESENT

The peak year for bathing at Hot Springs was reached in 1946, largely due to the lifting of wartime travel restrictions and to use by former military personnel who had experienced the thermal waters earlier in rest and rehabilitation programs. But bathing declined in the late 1940s, particularly at the Government Free Bathhouse. Improved economic conditions, medical advances, and antibiotics helped cut sharply the number of visitors seeking help for venereal diseases at the Free Bathhouse. By 1957 the Free Bathhouse was converted to a physical medicine facility and indigent bathers were referred to the other bathhouses where their fees are paid by the government. The steady decline in bathing has continued to the present. In 1962, the Fordyce Bathhouse closed its doors, followed by the Maurice, the Hale, and the Ozark in the 1970s and the Superior and the Quapaw in the 1980s.

After World War II, the trend towards increased recreational use of the area continued. Proposals for promenade completion were justified on the grounds that this would add to the recreational possibilities of the park. The classification problems of Hot Springs as a national park were still apparent and, to some extent, hindered development of the area. Instead of concentrating on the spa theme, development proposals and park management strategies were often drawn from the large primitive-area parks and seemed to focus on the natural landscape and biotic preservation. As a result, little attention was paid to Bathhouse Row, other than maintenance of facilities.

After over 15 years of negotiations and discussion, the old power poles belonging to the Hot Springs Power Company were removed from Bathhouse Row during the late 1940s. A new centralized cooling system--consisting of a heat transfer system, a reservoir, pumps, pumphouse, and associated equipment--was finally completed in 1950. It was sited in the southern part of Arlington Lawn near the tufa cliffs and involved a great deal of ground disturbance. Following construction, the antiquated cooling towers belonging to the individual bathhouses--some dating to the early part of the century--were finally removed. Early in the 1960s, a new heat-exchanger building was erected, and screening plants and a fence were installed.

In 1951 an elevated area of ground once used as a band platform was removed from the Arlington Lawn and the area was graded, seeded, and sodded. The nearby stone steps and retaining wall were renovated, and vegetation was cut to allow better visibility. In 1958 the main entrance was further altered by removal of the concrete oval quadrants, the base of the old exedras. These were replaced with low plantings and ground cover. The drive was reworked to change it to a pedestrian walkway and to prevent use by vehicles.



Figure 7. Main Entrance, 1984
(Source: Historic American Buildings Survey)

During the 1950s, the promenade proposals were revived, additional changes were made in the plans, and the project was finally completed in 1959. For the most part, a simplified version of the 1930s and 1940s plans and alignments was used. The elaborate cascade was omitted, the walkway width was reduced, the terrace just north of the Fordyce was graded back, and the new promenade structures were integrated into the Stevens Balustrade and the old main entranceway. The superintendent's residence was razed and the area was graded prior to the final work on the north end of the promenade. A modest, naturalistic cascade of hot water was added near the north end of the promenade late in the period, long after promenade completion. Although various proposals were made to improve the rear view of the bathhouses as seen from the new Grand Promenade, these plans were never implemented. Instead, over the years the vegetation along the Promenade was allowed to grow, closing off the view in all but a few areas.



Figure 8. Grand Promenade, Looking North, 1984
(Source: Historic American Buildings Survey)

DESIGN AND DEVELOPMENT

Effective management of the historic Bathhouse Row landscape can only be accomplished if a background history is first compiled. The preceding Historical Overview section presents a summary of the area's history. People, events, and expressions of architecture and landscape architecture, important to the development and character of the row, are found in that section.

The design and development history of the landscape is the focus of this section. Landscape design philosophies which influenced the development of Bathhouse Row are discussed first. These influences provide an understanding of the broad framework of American landscape design occurring at the time that the Bathhouse Row landscape was being developed. Three specific periods of Bathhouse Row landscape development are then discussed. The identification and discussion of these significant development periods provide the information necessary to evaluate the historical integrity of today's landscape. Evaluation of integrity occurs in the next section.

LANDSCAPE DESIGN INFLUENCES

Most of the Bathhouse Row landscape was designed and constructed at a time when a major philosophical shift in architectural and landscape design styles was occurring in America. Prior to the 1880s various modes of architecture produced buildings relatively vague in form with a romanticized mix of several eclectic styles. However, the "new" architecture that was initiated in the 1880s was marked by a more direct expression of a single eclectic style. Buildings were no longer vague in form but positively imitated a particular style of European architecture.

This emphasis on more architecturally pure and architecturally delineated building styles produced a similar refocusing in landscape architecture. The landscape settings for the architecturally vague buildings prior to the 1880s deemphasized the importance of a well-structured framework of outdoor spaces. Consequently, landscape treatments ignored geometric spaces as per the style of the eighteenth-century English landscape gardening school. Proponents of this school, both in England and later in America, replaced the geometric spatial forms immediately surrounding the building with more "naturalistic" rolling lawns and masses of shrubs and specimen trees. This pastoral and picturesque landscape style was architecturally formless enough to accommodate any of the mixes of eclectic building styles that it surrounded. It was this romanticized style of landscape design that was predominantly used until the 1880s.

When a single eclectic style of architecture was emphasized after the 1880s, the strength and clarity of building architectural form demanded that the immediate environs reflect the architectural character of the building itself. Landscape designs other than the soft monotones of the English landscape gardening school gained recognition in America. A greater emphasis on formal, structured design resulted from this need to provide a spatially well-structured landscape closely related to the

building. While the pastoral landscape treatment now proved to be inadequate adjacent to architecturally distinct buildings, it was still used as a means of creating a transition from structured to natural landscapes.

Designers of public and commercial types of buildings adopted the new architecture and its associated landscape more quickly than residential designers. However, by the 1920s, the more formally designed and formally delineated landscape was very much a part of the American landscape design philosophy.

SIGNIFICANT LANDSCAPE DEVELOPMENTS

There were three periods of site planning that contributed significantly to landscape development of Bathhouse Row and its environs. The first, dating from around 1877 to 1884, occurred when the Hot Springs Commission laid out the town and defined areas where development should occur. Shortly thereafter, Hot Springs Creek was arched over and the narrow, circumscribed valley floor was leveled, creating a unified linear landscape space in front of, and including, the row of Victorian style bathhouses.



Figure 9. Construction of the Hot Springs Creek Arch, 1883-84
(Source: Garland County Historical Society; cited by Brown, 1982, p. 36)

Between 1892 and 1897, the basic landscape treatment of the present Bathhouse Row park was established under the direction of Secretary of the Interior John Noble and Lieutenant Robert Stevens. Their landscape plan combined the Victorian, or less formal, landscape treatment with the post-1880s landscape philosophy that used more formal architectural spaces. Created were: the Magnolia Promenade; the mixed treatments of landscaped bathhouse frontages; the various architectural entrances which accessed the upper terrace; a series of small formal-to-natural open parks with trees, flowers, and shrubs along the upper terrace; and smaller elements characteristic of the Victorian picturesque landscape such as fountains, vine-covered retaining walls, and a series of narrow pathways and carriage roads.



Figure 10. Central Avenue and Bathhouse Row, View Looking North, 1906
(Source: Gem Souvenir, 1906)

The third, and final, phase of development that significantly defined landscape spaces began during the 1930s. Design and construction was confined to the upper terrace and involved creation of a brick-paved Grand Promenade with sitting areas, fountains, vista points, and three major architectural entrances.



Figure 11. Grand Promenade, Looking North, 1984
(Source: Hot Springs National Park)

By the time Stevens' design and construction efforts commenced, three primary landscape spaces were already topographically and functionally determined. Topography at the base of Hot Springs Mountain had been recontoured somewhat to form an upper terrace, and a lower terrace had been formed by containment of Hot Springs Creek in a masonry arch and

backfilling with soil. The lower terrace was at street level and was bounded on the west by Central Avenue for some 1,700 feet between Reserve Avenue and Fountain Street. This level functioned as the Reservation's public front upon which Victorian-style bathhouses, walks, and entrances to the upper terrace had been built.

The second or upper level utilized, with some modification, a terraced natural area to accommodate roads and walking trails. This area was immediately behind the row of bathhouses.

A third landscape space included all of the western slope and ridge area of Hot Springs Mountain above the upper terrace. Functionally, this space accommodated a system of recreational carriage roads and walking trails.

Stevens' plan embraced each of the major landscape spaces, including all of Bathhouse Row, the upper terraced area immediately above and behind the bathhouses, and the wooded mountainside. Concerned with both form and function, Stevens' design divided the terrain into distinct landscape units, each with its own spatial arrangements and emphasis. The lawn park unit, or public front, designed by Stevens definitely reflected a mix of pre- and post-1880s styles of landscape treatment. The naturalistic landscape style was expressed in the expanses of open lawns, and later in foundation plantings that abutted the buildings. Foundation plantings were used along the high foundation walls to soften and conceal them. By 1914, formality of spatial definition was imposed upon the informal open lawns by hedges that acted to separate and compartmentalize one bathhouse lawn from another.

Turn-of-the-century gardens were highly structured architectural spaces. One of the strengths of this period, the long axial element which tied garden spaces together, was borrowed from the French style. Stevens formalized the Magnolia Promenade in this style as a tree-lined pedestrian axis along the entire length of Bathhouse Row. The promenade was



Figure 12. Bathhouse Row, ca. 1894-95 (Note double row of trees along inside of Promenade--Source: Mitchell, Scenes in Arkansas, 1896)

culminated by the huge Hoke Smith Fountain at the north end and the Noble Fountain at the southwest corner. The wide magnolia-bordered promenade functioned as the primary design element to visually and physically connect the separate bathhouse lawn areas into one integral lawn park unit. The use of similar trees in a linear arrangement also softened the architectural differences among the bathhouses. Besides providing a formal landscape setting for the lawn park, Stevens also wanted a landscape space that could accommodate a fair amount of pedestrian use going to and from bathhouses, walking for exercise, and gatherings for social activities.

Stevens laid out four smaller landscape units or "park" areas--the South Park, the Foreground Park, the Tufa Park, and the Wooded Park--along the upper terrace behind the bathhouses. As designed, the four park areas formed a series of "natural" parks along the terraced way with walks, walls, and benches for resting; carefully laid-out carriage roads; and groupings of shrubs, trees, and large raised beds of flowers set in grass lawns. This terrace gave the effect of an upper front over the street since it was generally on a level with the Army and Navy Hospital grounds, and formed a continuous embankment around the lower part of the mountainside. This curvilinear landscape space also created a transition zone between the formal architecture and landscape of Bathhouse Row below and the wooded slopes above.

The South Park, later known as Reserve Park, extended from the Government Free Bathhouse south to Reserve Avenue. Bordered by the bathhouse supply road and the Army and Navy Hospital grounds, this park was accessed by stone stairs and landings which extended up the hillside between the Ozark and Rammelsburg bathhouses. Here the "natural plantings"--chiefly shrubbery and lawns--provided an open green expanse in contrast to the large Army and Navy Hospital structures above.



Figure 13. Bathhouse Row, with South Park beyond, ca. 1896 (South Park is pictured directly behind bathhouses and stone stairs--Cutter's Guide, 1896)

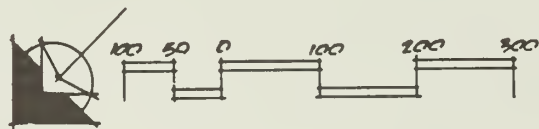

PREPARED <i>G. Johnson</i> DESIGNED <i>G. Johnson</i> DRAWN	TITLE OF DRAWING SITE PLAN BATHHOUSE ROW LANDSCAPE 1890's	DRAWING NO 128 25,002A
CHECKED 6/85 DATE		PKG NO. _____ SHEET _____ OF _____

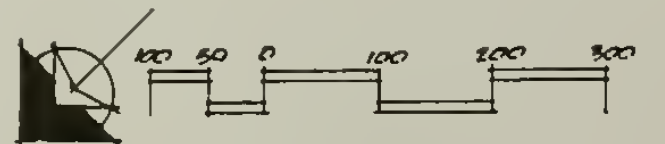
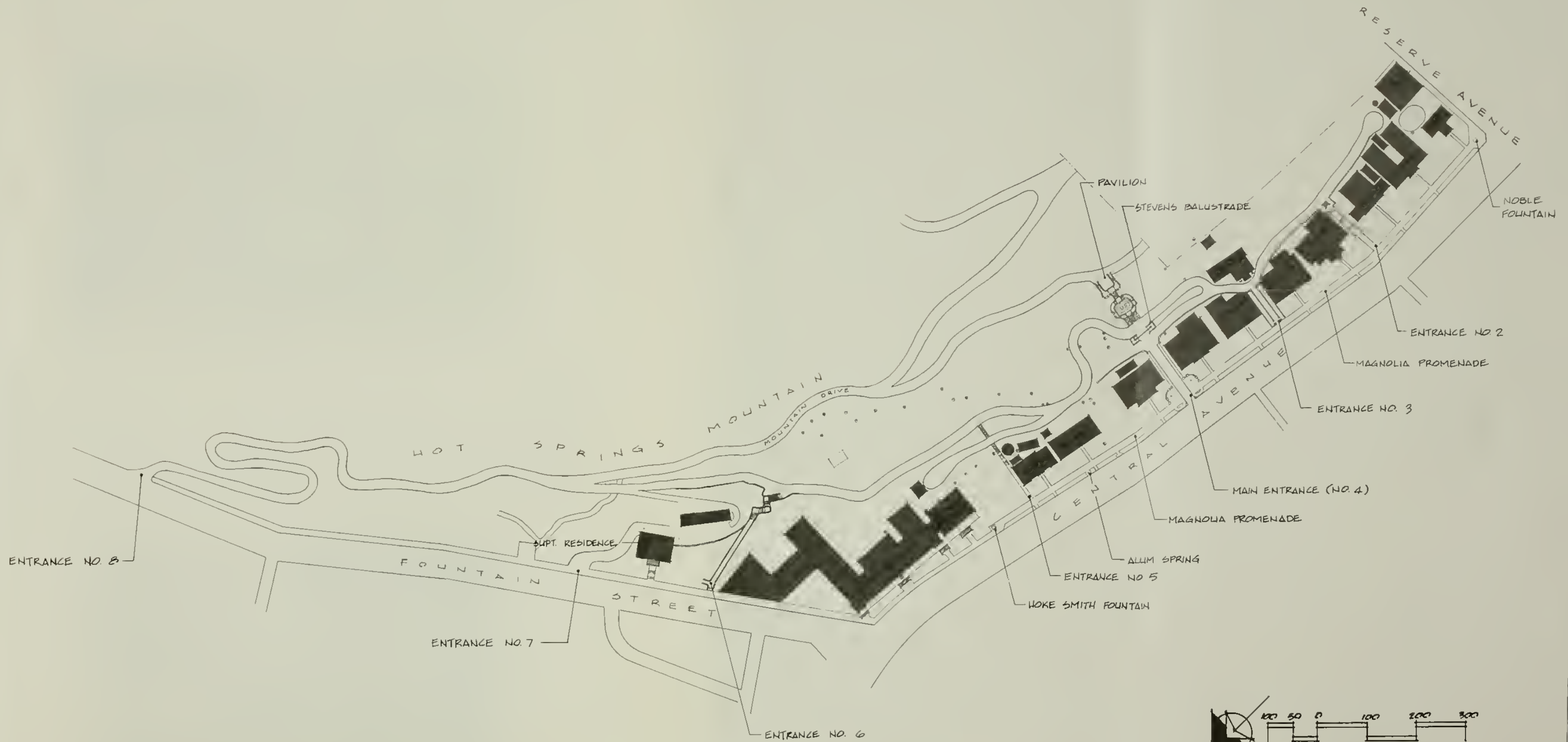

PREPARED <i>G. Johnson</i> DESIGNED <i>G. Johnson</i> DRAWN CHECKED <i>G/ES</i> DATE	TITLE OF DRAWING SITE PLAN BATHHOUSE ROW LANDSCAPE 1890's	DRAWING NO 128 25,002A PKG NO SHEET OF
---	---	---

The Foreground Park lay just above and beyond the main entrance. It was bounded by stone retaining walls on the downhill side, and uphill by the main drive and woods. The center of this park was a terraced, tree-shaded area with massed plantings which formed a circular intermediate landing for the main entrance stairway; above was the bandstand pavilion.



Figure 14. Foreground Park, ca. 1914
(Source: Hot Springs National Park)

Just to the north of the Foreground Park was the Tufa Park which continued around the mountainside to a point adjacent to and behind the Arlington Hotel. In this park the natural features of the tufa were left exposed, and plantings of vines and shrubbery were kept to a minimum. Although the clusters of wooden cooling tanks were still visible behind the various bathhouses, the unsightly system of above-ground wooden troughs and piping had been removed, the springs had been arched over with white rustic stone, and grass had been planted to complete the improvement of this area.



Figure 15a. Tufa Fountain located in the Tufa Park, ca. 1913-1914
(Source: Hot Springs National Park)



Figure 15b. Trail through Tufa Park, ca. 1913-1914
(Source: Hot Springs National Park)

The Wooded Park abutted Fountain Street and the Tufa Park. The superintendent's office and residence were set in this park--a typically Victorian lawn and garden with vine-covered walls, exotic plants, flowering shrubs, and beds of annuals. This confined area was in turn surrounded by a natural wooded area, broken only by footpaths leading to the main road.



Figure 16. Superintendent's Residence, Fountain Street, ca. 1906
(Source: Hot Springs National Park)

The Foreground Park and the main, or Central Avenue, entrance leading between the Independent and Palace bathhouses formed the core of the Reservation's formal landscape. Formal structure in the Italian style found its expression in the Bathhouse Row landscape in the architectural treatment of this space. Italian landscape designs typically used architectural elements--balustrades, balconies, paved terraces, and stairways--to structure space and traverse topographic obstacles. Stevens used elements of the Italian style to physically provide access to the upper terrace and to construct an architectural axis that provided a strong line of sight from Central Avenue to the pavilion located on the upper terrace. Tall stone columns topped by bronze eagles, joined by curved panel walls and abutting exedras with fountains, provided a strong architectural definition of space at the Reservation's main entrance. At the rear, the entrance drive and sidewalks led to a white stone balustrade and shell fountain, plantings, stairs, and a bandstand pavilion set among the trees in the foreground area. Retaining walls stretched along the rear of the bathhouses. In keeping with the scale of the adjacent bathhouses, the main entrance provided a natural entranceway to the reservation and to the mountain above while allowing service to the rear of the bathhouses. The stone stairs, balcony, balustrade, and plantings formed a formal composition of architectural elements leading to the pavilion--a small but elegant structure intended to provide a resting spot--and a platform for viewing the city below.



Figure 17. Foreground Park, Bandstand, before 1914
(Source: Hot Springs National Park)

Although more modest, other entrances also provided access to the wooded and terraced areas above and to vistas from the mountain paths. On the southern end, a double stone stairway led from Reserve Avenue to the foreground in the same area occupied today by the south entrance to the Grand Promenade. The second entrance was a succession of stairways with side exedras that led from the bathhouse level to the

foreground park just west of the War Department grounds. Entrance number three formed the opening to the Government Free Bathhouse--a series of stairs, side courts of novaculite stone, and retaining and parapet walls. The main entrance was the fourth, while the fifth entrance connected the Arlington Hotel grounds with the upper terrace. Entrance number six was at the superintendent's residence and grounds; it was formed by successive flights of steps and landings cut into the tufa. A double iron gateway with flanking stone columns enclosed the driveway from Fountain Street to the superintendent's house forming entrance number seven, and a road connecting with the main Hot Springs Mountain drive was entrance number eight.

The Reservation fountains were not only an ornamental part of the Victorian and post-1880s landscape, but also provided hot drinking water, previously unavailable outside the bathhouses and hotels, for Reservation visitors. Fountain designs were less ornate than during the Victorian



Figure 18. The Hoke Smith Fountain, date unknown (Source: Hot Springs National Park)



Figure 19. The Noble Fountain, late 1890's (Source: Hot Springs National Park)

period, mostly sculptured from stone not cast iron. During the 1890s, "display" springs were formalized and structured. Several springs--among them Dripping Spring, Hale Spring, and Stevens Spring--were arched over with white limestone facades and used to provide hot water for drinking. Attractive stone and wood pavilions, since removed, sheltered Alum Spring along the promenade and Cold Spring at the Fountain Street entrance. Most of the remaining springs were covered over and diverted to bathhouse use.



Figure 20. Stevens Spring, date unknown
(Source: Hot Springs National Park)



Figure 21. Alum Spring and Pavilion, date unknown
(Source: Hot Springs National Park)

The transition from the formally defined landscape spaces to the sodded mountainside above the upper terrace was accomplished by treating the landscape in the English gardening style typical of American landscapes prior to the 1890s. Both the informal layout of trees and the predominance of plant materials in this style provided the required effect. In addition to the careful definition of landscape spaces, Stevens' planting plans used a combination of exotics; subtropical plant materials; vines; raised-massed floral plantings; and native trees such as American holly, walnut, and black gum to complete his design. Stevens recommended judicious thinning of existing trees to restore natural woodland effects and to open up vistas on Hot Springs Mountain.



Figure 22. Upper Terrace on Hot Springs Mountain, Looking Northeast at Informal Plantings, 1898
(Source: U.S.D.O.I., Report of the Superintendent)

By 1900 three and one-half miles of roads had been built on Hot Springs Mountain, the largest of the three landscape spaces. Stevens designed these mountain roads and trails to be both scenic and easily maintained, and to follow the natural topography of the mountainside. Attractive stone bridges and retaining walls were also built on the mountainside during the 1890s project.



Figure 23. Stone Culvert on Hot Springs Mountain, date unknown
(Source: Hot Springs National Park)

Construction of the larger and more architecturally distinctive bathhouses between 1911 and 1922, compromised Stevens' upper terrace parks both spatially and functionally. Supply road alignments were shifted uphill as tufa slopes were cut back to make room for the new structures.

Entrances between bathhouses that provided access to the upper terrace from the promenade were narrowed and their architectural prominence lessened.

Under Stevens' development scheme, each of the four upper terrace parks were strong spatially and tended to function separately. While the overall space was linear in nature, the separate park units lacked a common axial element to connect them. The supply roads and mountain scenic roads that traversed the parks provided only a weak connecting element.

Early in the 1930s, the third period of general development planning for Bathhouse Row was initiated. This plan called for the formal development of the upper terrace with a hot water cascade area and a new promenade with large architectural entrances on either end. After several years of plan revisions and delays, the grade for the Grand Promenade was constructed the length of the upper terrace. It was formal in style with long tangent sight lines.

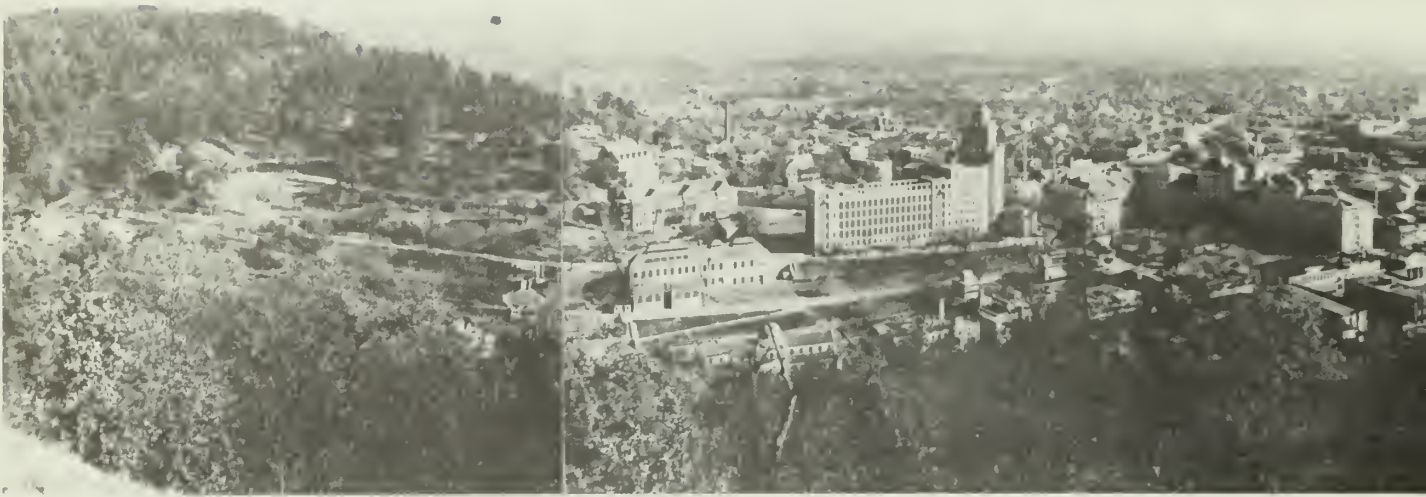

Figure 24. Bathhouse Row and Upper Terrace with Promenade Grading Completed, ca. 1937
(Source: Hot Springs National Park)

Axial development of the promenade provided the architectural link needed between Stevens' park units on one hand, and on the other it diminished their spatial integrity. To attain flat grades and straight alignments, the character of the South Park and Tufa Park units was altered by excavation of tufa and sandstone outcrops. Extensive planting of trees and shrubs along the promenade further altered the spatial openness and enclosure of Stevens' design. For a comparison of the Bathhouse Row landscape just prior to and after construction of the Grand Promenade, see the Site Plans, Bathhouse Row, Early 1930s and 1985.

With the above-mentioned changes in spatial character along the upper terrace, Stevens' delineation of the four parks was no longer functionally appropriate. With the completion of the Grand Promenade the upper terrace was consolidated into a single landscape unit. Therefore, rather than Stevens' five park landscape units, the landscape now consists of two units, the Lawn Park and Foreground Park (Grand Promenade).



Figure 25. Lawn Park, Looking North, 1970's
(Source: Hot Springs National Park)

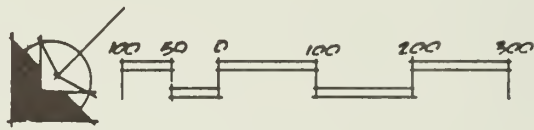

DESIGNED: G. JOHNSON	SUB SHEET NO.	TITLE OF SHEET	DRAWING NO.
DRAWN: G. JOHNSON		SITE PLAN	128
TECH. REVIEW:		BATHHOUSE ROW LANDSCAPE	25,003
DATE 4/85		EARLY 1930'S	PKG. NO. SHEET
			<input type="checkbox"/>
			OF

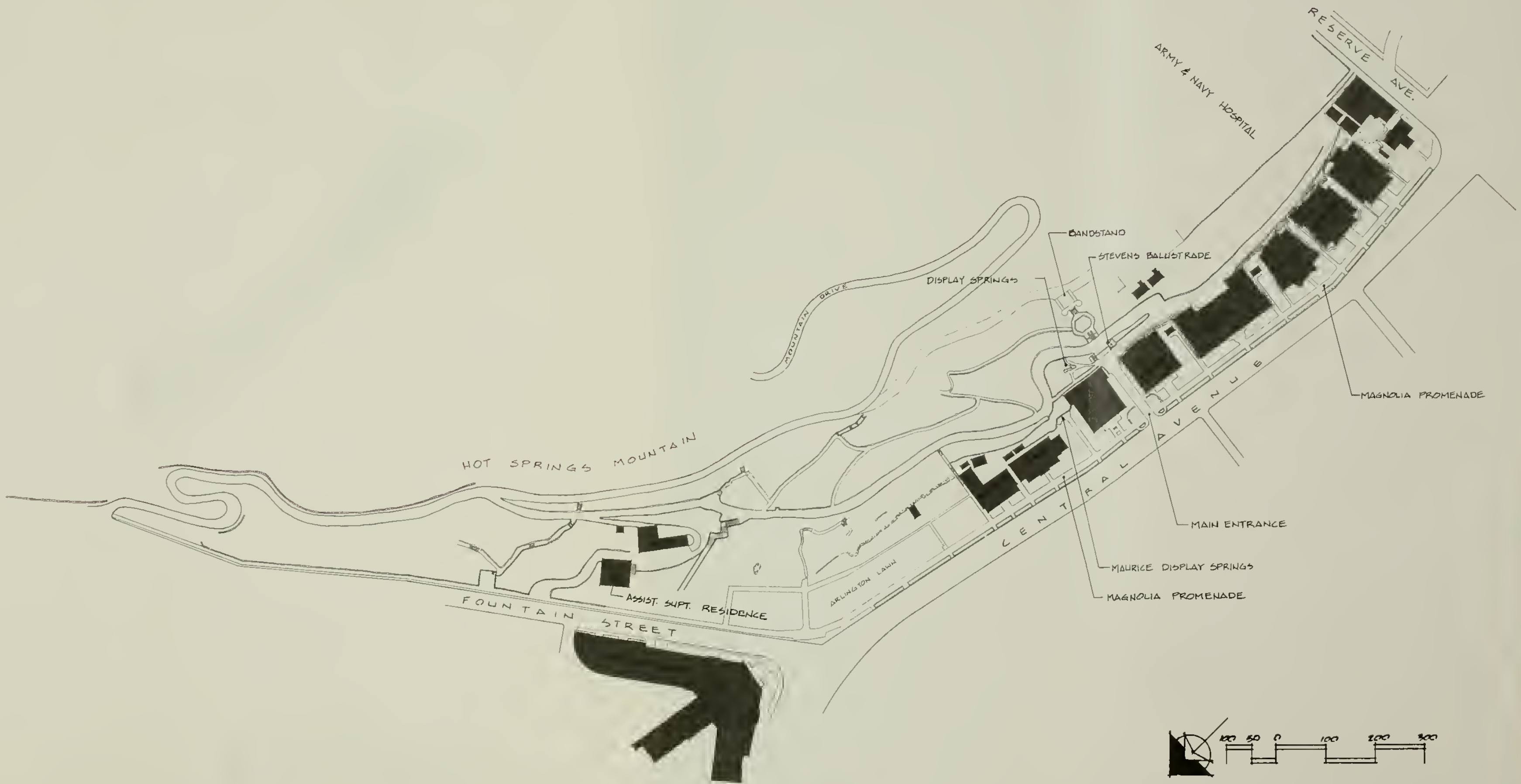

DESIGNED G. JOHNSON	SUB SHEET NO.	TITLE OF SHEET SITE PLAN BATHHOUSE ROW LANDSCAPE EARLY 1930'S	DRAWING NO. 128
DRAWN: G. JOHNSON			25,003
TECH. REVIEW:			PKG. NO. SHEET
DATE 4/85			OF

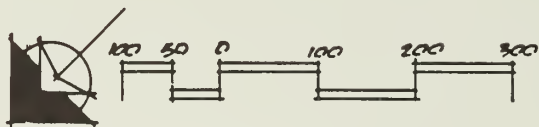
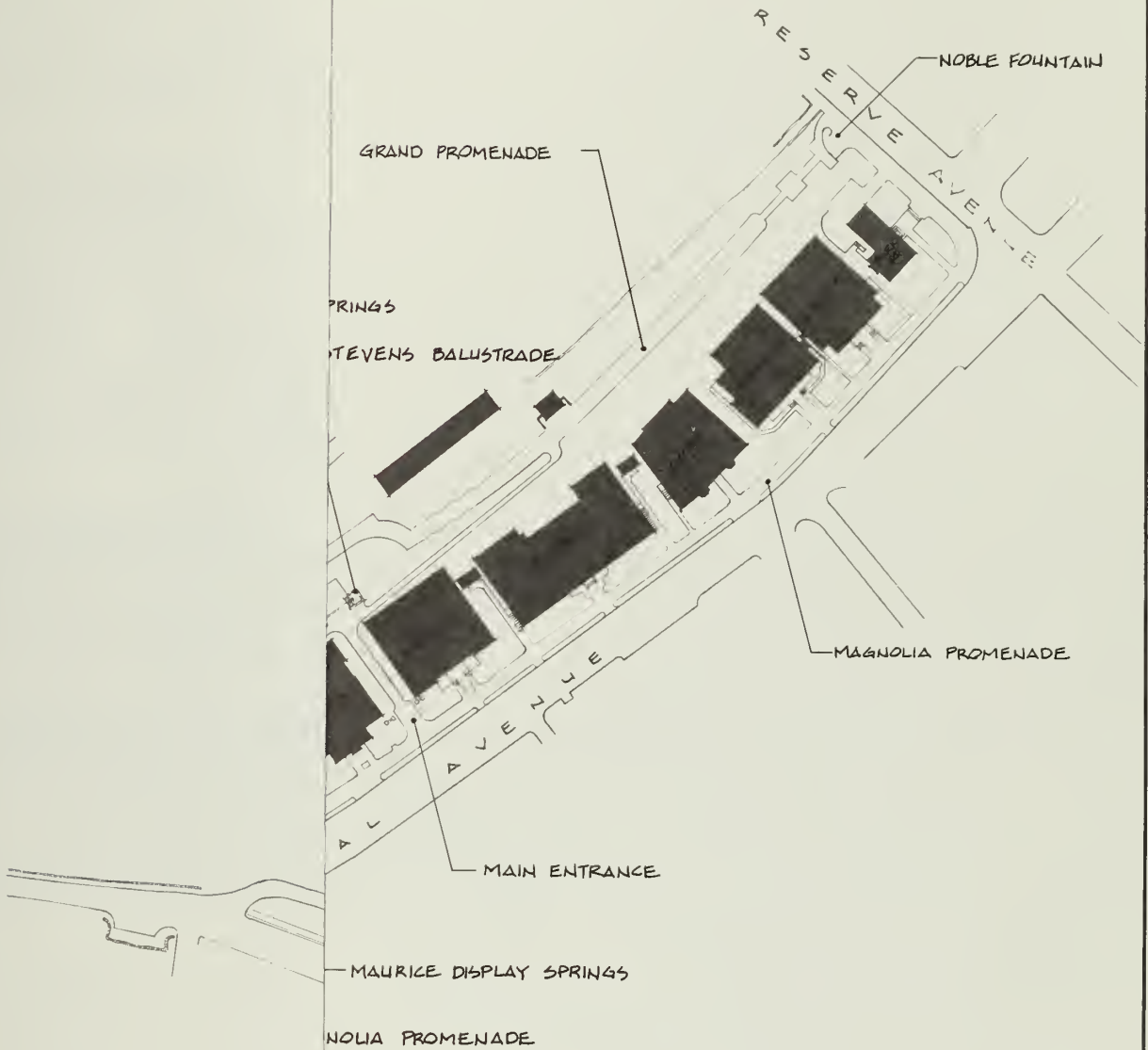

DESIGNED: G. JOHNSON	SUB SHEET NO.	TITLE OF SHEET	DRAWING NO.
DRAWN: G. JOHNSON		SITE PLAN	
TECH. REVIEW:		BATHHOUSE ROW LANDSCAPE	PKG. NO.
DATE: 4 85		1985	SHEET
			OF

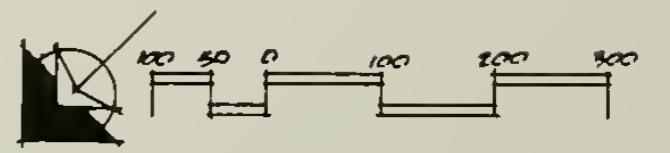
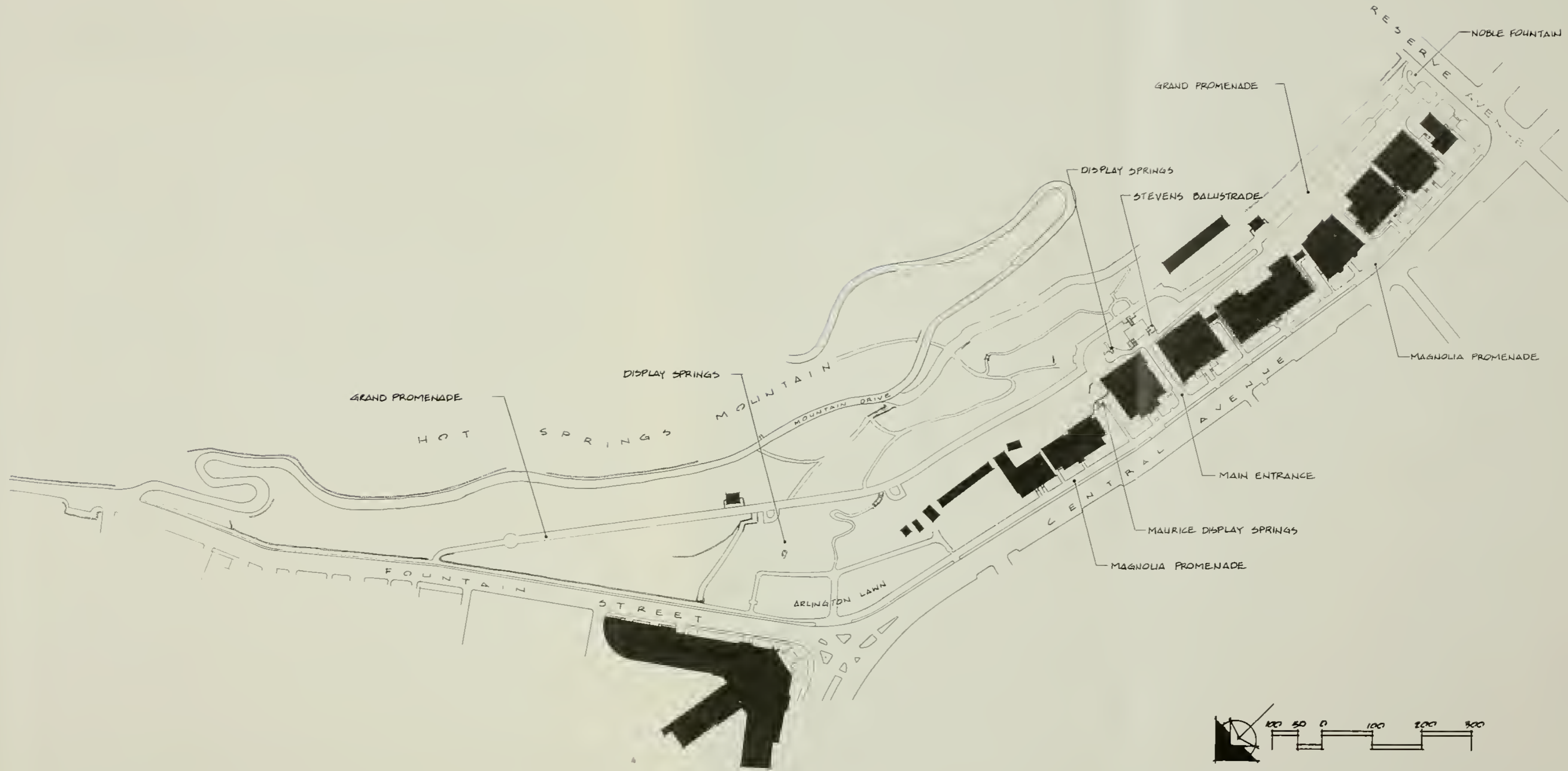

DESIGNED: G. JOHNSON	SUB SHEET NO.	TITLE OF SHEET SITE PLAN BATHHOUSE ROW LANDSCAPE 1985	DRAWING NO.
DRAWN: G. JOHNSON			
TECH REVIEW:			
DATE: 4/85			
	PKG. NO.	SHEET	
		OF	

INVENTORY / EVALUATION

ANALYTICAL PROCESS

Following the analysis discussed in the Historical Overview and Design and Development sections, a three-part process was then used to establish historical significance and determine management direction for maintaining the historical integrity of the Bathhouse Row landscape.

Inventory/Evaluation: Landscape subunits that appear homogeneous in terms of spatial structure and character, function, and architectural elements, were identified. These subunits were then evaluated and given relative historical integrity ratings which are a measure of a subunit's apparent degree of similarity to its historic spatial structure and character, function, and architectural elements. A second rating was applied to each subunit based upon its visual accessibility as determined by the frequency of pedestrian travel through and/or the visibility of a subunit space. Visibility of a landscape space was determined by its proximity to major viewing routes and key observation points.

Management Classes: The relative degrees of subunit historical integrity were then translated into management classes. Management classes describe landscape significance and the different degrees of modification allowed to the basic features of a single or related landscape subunit. They are stated in terms of accepted degrees of contrast between proposed modifications and the existing landscape.

Compatibility Assessment: To evaluate specific modification proposals, a rating system to measure the degree of contrast is discussed as a final step in the analytical process.

The relationships between process steps are graphically shown on the following Analytical Process flow chart.

ANALYTICAL PROCESS

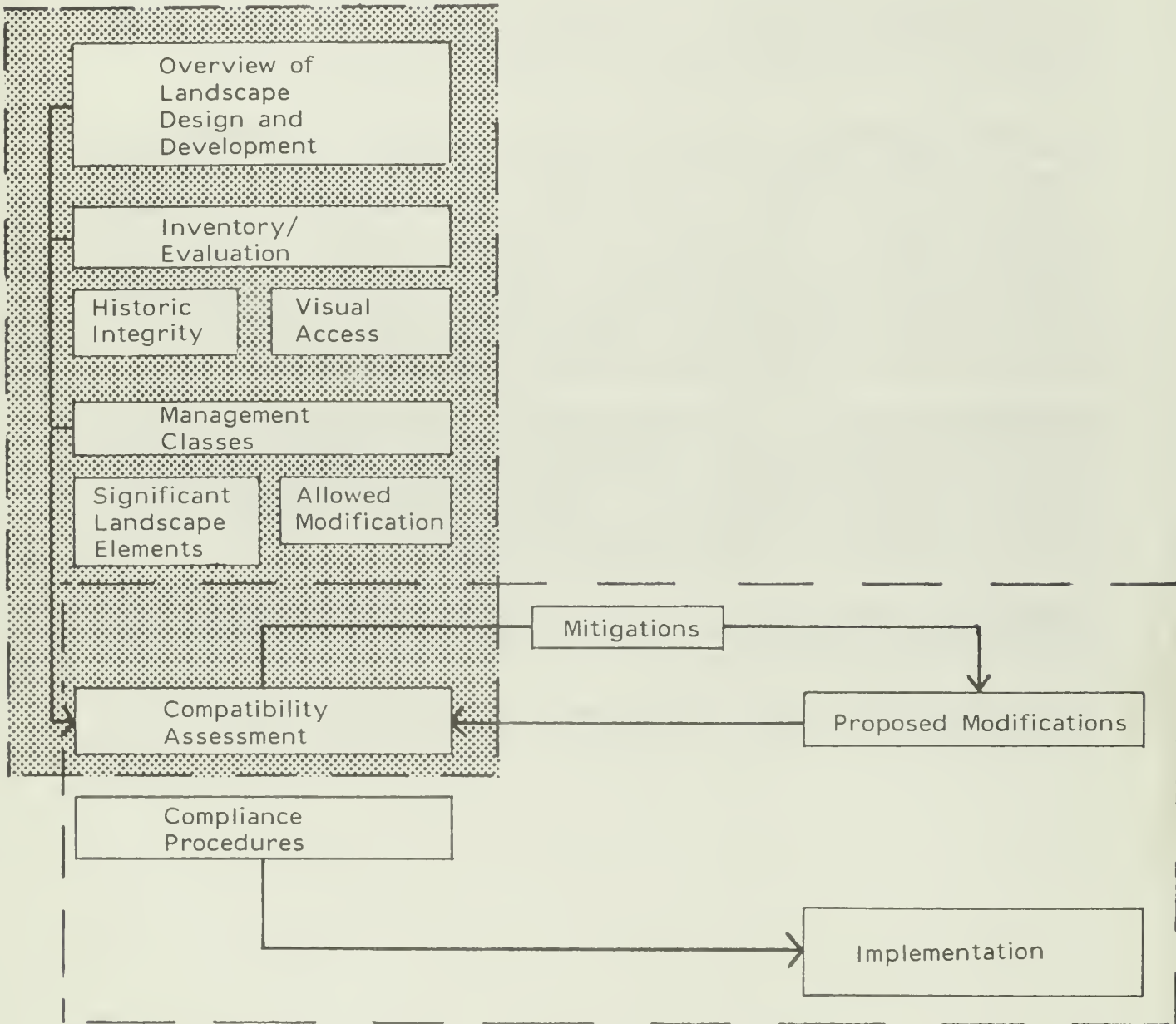

INVENTORY

Identification of Subunits

Today, Bathhouse Row consists of two major landscape units: the Lawn Park which continues to provide the main public front for the bathhouses, and the Foreground Park which includes the entire upper front terrace traversed by the Grand Promenade. Neither landscape unit is uniform throughout with respect to spatial structure and character, architectural elements, or functions. Instead, they are a series or collection of subunits defined by these features. The subcomponents of the landscape units provided a logical means to divide the two main units into manageable subunits for purposes of inventorying and evaluating the landscape setting.



Figure 26. Lawn Park (including Arlington and Bathhouse Lawns) and Foreground Park behind Bathhouse, Looking South, 1984
(Source: Hot Springs National Park)

Landscape subunits having similar spatial structures and character, functions, and architectural elements were determined by analyzing site plans, aerial photographs, written documents, and field work.

A summary of the site analysis findings is presented in the Evaluation section and on the three Spatial Organization and Function Analysis maps included in the Appendix. Spatial organization of the landscape was determined by identifying topographic and vegetation features, circulation networks, and visual boundaries. Visual boundaries were delineated by landscape edges, views, openness/enclosure, lines of sight, and focal points.

This analysis led to the identification of six subunits in the Lawn Park unit including the Magnolia Promenade, bathhouse lawns, the main entrance, Arlington Lawn, display springs, and a transition area. Three subunits were identified for the Foreground Park unit; they are the Grand Promenade, open lawn bays, and open woods (see the Landscape

Subunits map). The transition area just behind the bathhouses and Arlington Lawn presently functions as a vegetative buffer or a landscape edge between the two major landscape units, but it is included in the Lawn Park unit due to its earlier, historic function(s).

Description of Landscape Subunits

Description of the extant landscape is necessary because the appearance of the landscape at the present time provides baseline information to be used in evaluating landscape integrity, defining management classes, predicting impacts of proposed modifications, and determining mitigations for landscape modifications.

Landscape subunits are described on the following pages through photographs and through an inventory of selected features--spatial structure and character, functions, and architectural elements. Spatial structure of a site is defined as its configuration of physical open space. Generally, the spatial structure of Bathhouse Row subunits is the result of topographic characteristics, vegetation massing, architectural elements, or some combination of these. After spatial structure of the subunit was determined, spatial characteristics were established. The spatial character of a landscape subunit depended upon the size of a space, the degree of visual enclosure, and its visual character. The size of a space is important in determining its potential to absorb proposed modifications. Degree of visual enclosure is an important factor in determining the visual openness and form of a space. Maintaining a space's openness or enclosure is key to preserving its spatial character. Visual character is determined by a space's inherent visual image based upon the dominance of natural and/or cultural features. By identifying and protecting dominant landscape features from modification, the visual character of a subunit can be retained.

Description of subunits was not solely dependent upon spatial parameters but included function and architectural elements as well. Two aspects of function were identified--people's use of a space and use of plant materials or architectural elements to reinforce the purpose of a space. Architectural elements were important to note because they tend to dominate the small-scale landscape spaces of Bathhouse Row.

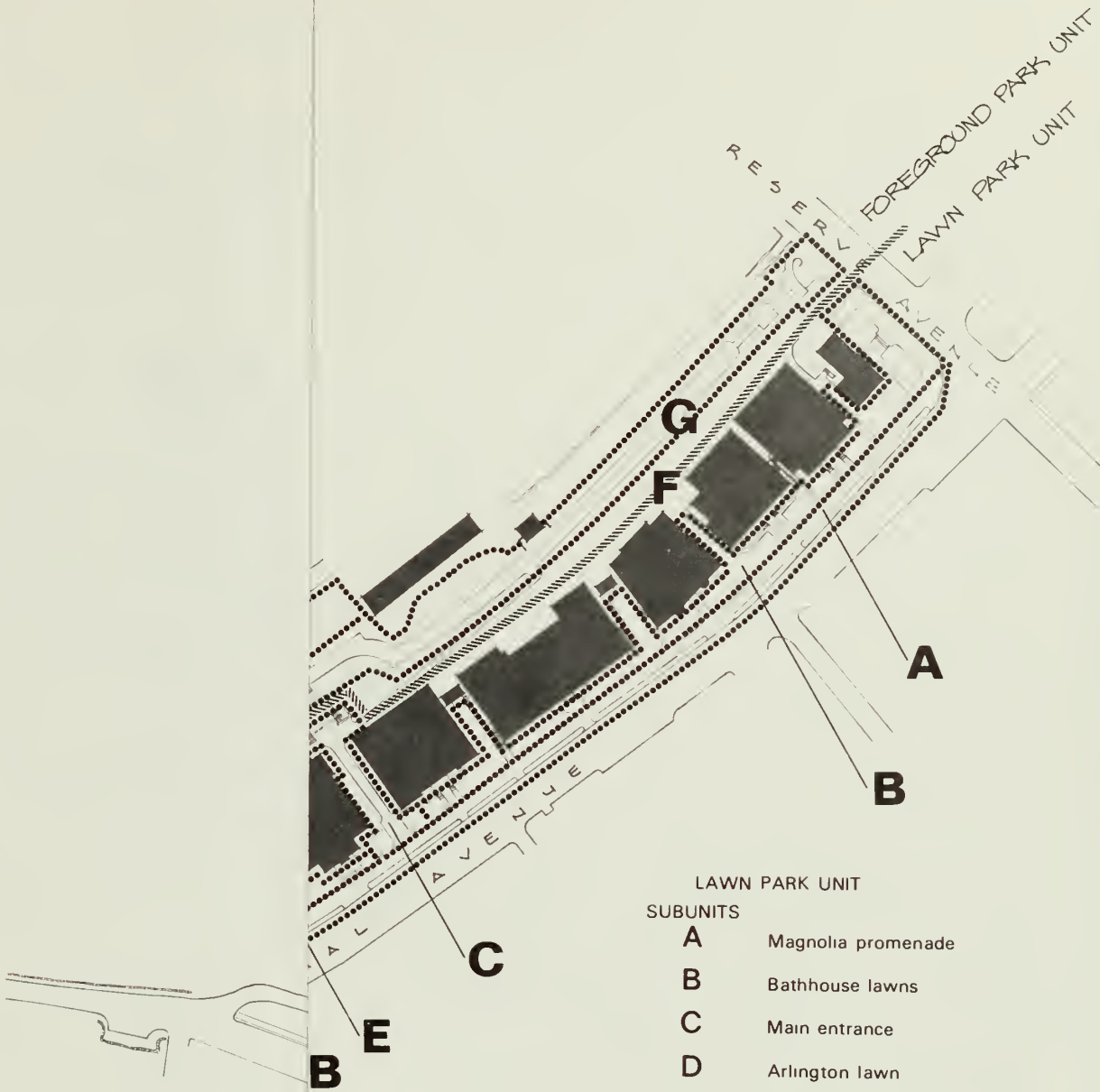

- LAWN PARK UNIT
- SUBUNITS
- A Magnolia promenade
 - B Bathhouse lawns
 - C Main entrance
 - D Arlington lawn
 - E Display springs
 - F Transition area
- FOREGROUND PARK UNIT
- SUBUNITS
- G Grand promenade
 - H Open lawn bays
 - I Open woods

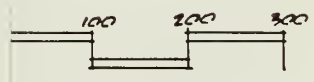

Boundary between lawn and foreground parks

Subunit boundary

DESIGNED: G. JOHNSON	SUB SHEET NO.	TITLE OF SHEET LANDSCAPE SUBUNITS	DRAWING NO. 128
DRAWN: G. JOHNSON		BATHHOUSE ROW LANDSCAPE	25,005A
TECH. REVIEW:			PKG. NO.
DATE: 6/85			SHEET
			OF

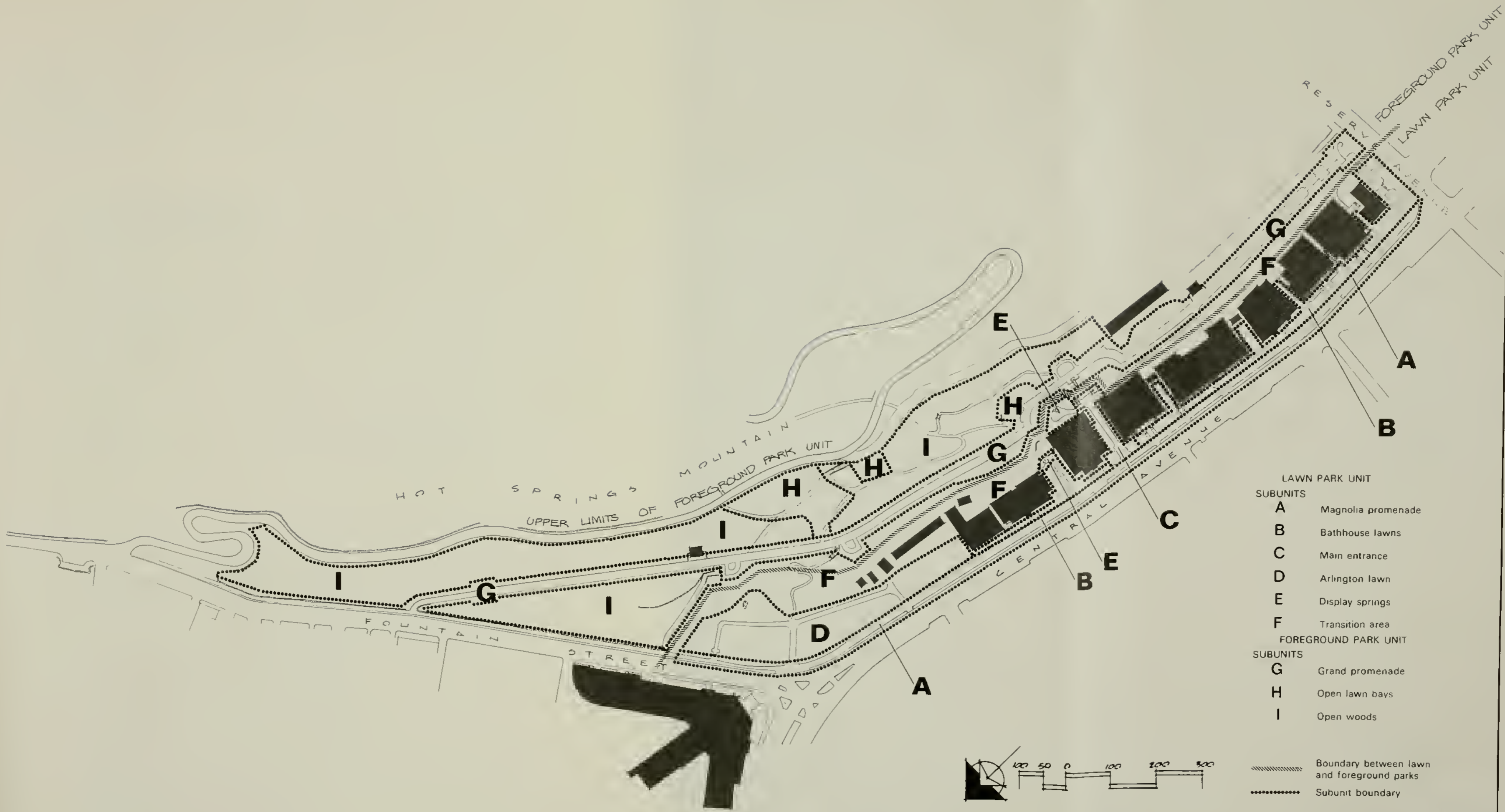

- LAWN PARK UNIT**
SUBUNITS
- A Magnolia promenade
 - B Bathhouse lawns
 - C Main entrance
 - D Arlington lawn
 - E Display springs
 - F Transition area
- FOREGROUND PARK UNIT**
SUBUNITS
- G Grand promenade
 - H Open lawn bays
 - I Open woods

----- Boundary between lawn and foreground parks
 Subunit boundary

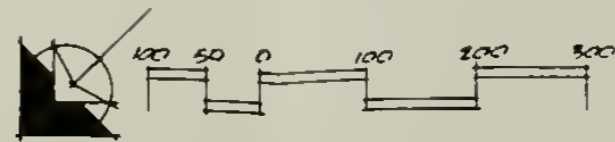

DESIGNED: G. JOHNSON	SUB SHEET NO.	TITLE OF SHEET LANDSCAPE SUBUNITS	DRAWING NO. 12 B
DRAWN: G. JOHNSON		BATHHOUSE ROW LANDSCAPE	PKG. NO.
TECH. REVIEW:		1985	SHEET
DATE: 6/85			OF

INVENTORY OF LANDSCAPE SUBUNITS

- A. Magnolia Promenade
- B. Bathhouse Lawns
- C. Main Entrance
- D. Arlington Lawn
- E. Display Springs
 - 1. Behind Maurice Bathhouse
 - 2. Beside Hale Bathhouse
- F. Transition Area
- G. Grand Promenade
- H. Open Lawn Bays
- I. Open Woods

A. MAGNOLIA PROMENADE SUBUNIT

SPATIAL STRUCTURE

Vegetation is the primary spatial determinant, as the landform is visually flat. Vegetation and architectural elements are seen as a series of essentially parallel lines and aligned objects appearing to converge to a point. This organization of space is typical of a focal landscape with open side views.

SPATIAL CHARACTER

A row of magnolia trees and specimen shrubs along the street side and a shrubby hedge along the walk's inside edge delineate the 14-foot-wide pedestrian corridor. There is a sense of implied space created by the low hedge and canopied shade tree row. This arrangement reinforces the linear movement along the promenade with views oriented ahead and to the open sides. Overall, the space has a feeling of breadth and is somewhat confined vertically by the overhead tree canopy.

FUNCTION

Pedestrian circulation is the primary function of this subunit. Movement through the subunit is reinforced by the repetition of plant materials and architectural elements.

The street-side row of magnolia trees reinforces the Central Avenue limits of the Lawn Park and of the park boundary.

ARCHITECTURAL ELEMENTS

14-foot-wide concrete walkway

Series of curbed islands and curb-cut ramps

Five-globe light fixtures

Hot water fountains

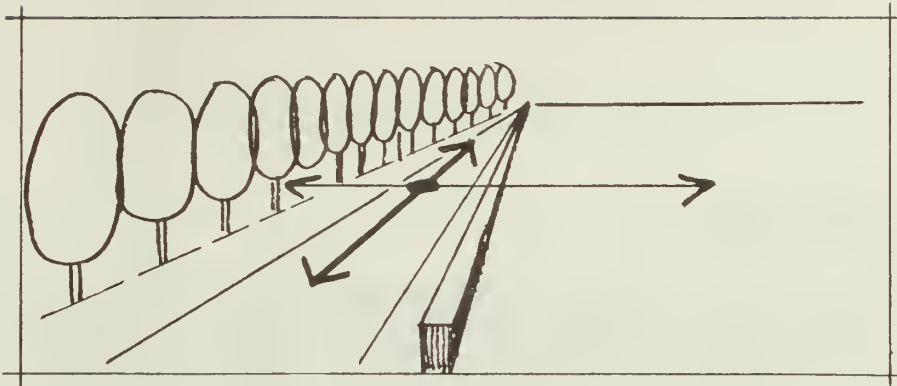

Figure 27. Focal Landscape Composition Sketch



Figure 28. Magnolia Promenade Subunit, Looking North, 1984
(Source: Hot Springs National Park)



Figure 29. Magnolia Promenade Subunit, Looking South, 1984
(Source: Hot Springs National Park)

B. BATHHOUSE LAWNS SUBUNIT

SPATIAL STRUCTURE

Building facades are the primary spatial determinant, limiting views and establishing a strong vertical edge. In this feature, dominant landscape subunit sight lines to and views of the building facades are complemented by a subordinate vegetation composition. The flat landform further enhances the spatial importance of building facades.

SPATIAL CHARACTER

A low hedge delineates lawns into rectilinear compartments and implies separate spaces in front of each bathhouse. Deciduous specimen trees provide shaded lawn areas and shrub plantings soften and conceal building foundations. Expanses of lawn and vegetation arrangements generally reinforce unobstructed views of the bathhouse facades. Overall, the subunit is partially enclosed with vertical building walls blocking views into and out of one side of the subunit; openness of the other three sides allows an outward orientation. However, the more strongly oriented views are towards the bathhouses because of their visually dominant facades.

FUNCTION

Provision of an immediate setting for the bathhouses is the primary function of this subunit. Walkways through the subunit provide pedestrian access between the Magnolia Promenade and each bathhouse. The spatial openness and the lack of seating, or other site amenities, to invite use encourages movement along or through the lawn subunit.

ARCHITECTURAL ELEMENTS

Concrete walkways and ramps of various widths and lengths

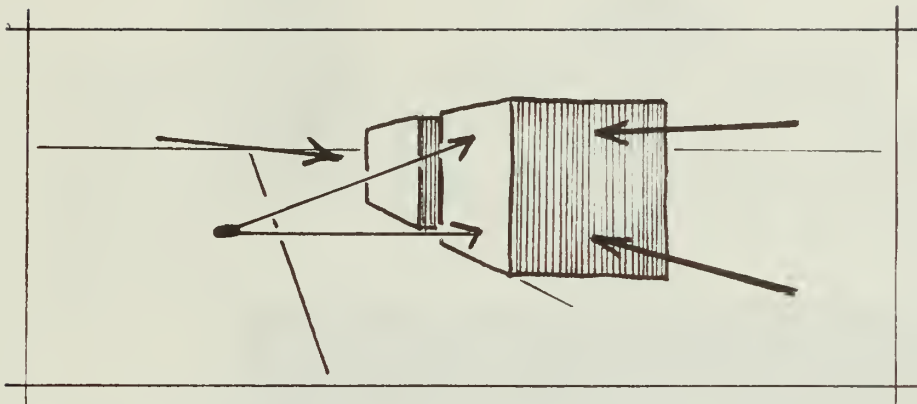

Figure 30. Feature Landscape Composition Sketch



Figure 31. Bathhouse Lawns Subunit, Looking at Quapaw Bathhouse Facade, 1984
(Source: Historic American Buildings Survey)



Figure 32. Bathhouse Lawns Subunit, Looking North, 1984 (Source: Hot Springs National Park)

C. MAIN ENTRANCE SUBUNIT

SPATIAL STRUCTURE

Architectural components are the primary spatial determinant, establishing strong vertical edges and defining a series of interrelated outdoor spaces along an axis. A sharp rise in topographic relief, accented by an architectonic balustraded terrace and stairs, defines an upper terrace behind the bathhouses. Vegetation softens the hard architectural edges but does little on its own to enclose space. The composition of space involves a focal landscape with an intermediate feature (balustraded terrace) and a series of enclosed-to-partially-open spaces.

SPATIAL CHARACTER

The sense of spatial enclosure varies along the axis from Central Avenue to the planted hillside above the Grand Promenade. Enclosure is strongly implied by three-story building walls situated on either side of the entrance walk from the columns to the Stevens Balustrade. Overall, the side enclosure afforded by the building walls lifts one's attention upward, but the lack of a strong focal point on the wooded slope diminishes the effectiveness of this subunit's sight line. The vertical orientation of this space diminishes at a cross axis just behind the bathhouses and in front of the Stevens Balustrade. Views at this point are open to the sides or back toward Central Avenue. The balustrade acts as an intermediate feature to provide access to the Foreground Park and to serve as a focal point. Upon reaching the balustraded terrace, space is open to semi-open and is defined by low architectural features and plant materials, to a lesser degree. Views at this level are open along the axis to Central Avenue with a less-than-dramatic, panoramic view of West Mountain. While this axis physically stops above the Stevens Balustrade where it intercepts the Grand Promenade, it continues visually up the wooded slope for a short distance.

FUNCTION

Pedestrian circulation between the Lawn Park and Foreground Park is the primary function of this subunit. Movement through the sequence of spaces is reinforced by a series of architectural components, topographic levels, and the repetition of plant materials. Of the three Grand Promenade entrances, this one provides the primary access.

ARCHITECTURAL ELEMENTS

- Concrete walkway
- Stevens balustrade
- Brick-paved terrace
- Stone-masonry stairway with observation terraces

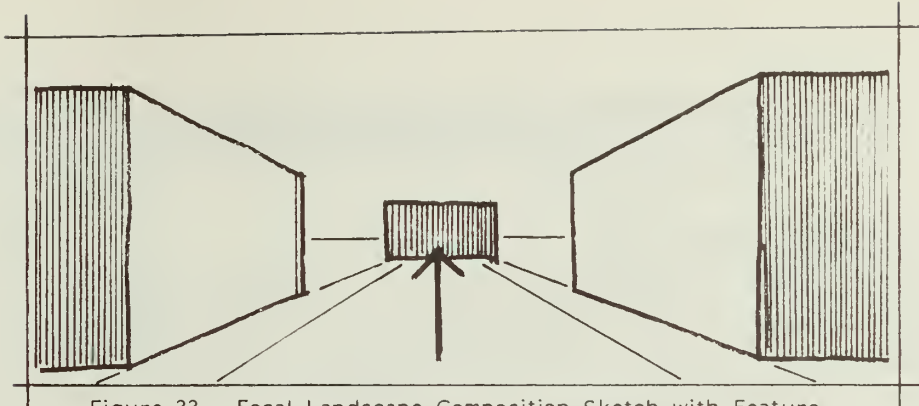

Figure 33. Focal Landscape Composition Sketch with Feature



Figure 34. Main Entrance Subunit, Looking toward Central Avenue, 1984
(Source: Hot Springs National Park)



Figure 35. Main Entrance Subunit, Looking toward Stevens Balustrade and Grand Promenade, 1984
(Source: Historic American Buildings Survey)

D. ARLINGTON LAWN SUBUNIT

SPATIAL STRUCTURE

Topographic relief and vegetation contribute equally as spatial determinants. They provide side walls around a base plane, or expanse of flat open lawn, to form an enclosed landscape space. Lines of visual attention are first drawn into the open area and then to the side walls that define the edges or limits of the base plane.

SPATIAL CHARACTER

This subunit is a long rectangular area, the largest open space of all the Lawn Park and Foreground Park subunits. Two rows of shade trees on either side of the Magnolia Promenade and a hedge visually enclose the street-side edge of Arlington Lawn. Except where the open lawn abuts the Superior Bathhouse, the remainder is enclosed by steep-to-moderate-sloping tufa rock outcrops. Various trees and shrubs growing on the slopes provide visual variety and interest, as well as softening the hard edges of the tufa outcrops. While the space is enclosed and views are oriented inwardly, the expansiveness of the lawn base plane reinforces a general feeling of openness both horizontally and vertically. Both the soft lines of gravel paths and the lack of vegetation to direct pedestrian movement complement a leisurely and less-defined use of this subunit. A large tufa boulder and hot water cascade provide a focal point in a corner of the lawn, but generally there is no one feature dominating the visual experience of the subunit.

FUNCTION

This subunit provides a contrast to the hard architectural edges of the surrounding city streetscape and a relief from confined or linear spaces devoted to pedestrian circulation. Its informal composition and expansive size allows this subunit to accommodate large social gatherings and events, but it is more commonly used by individuals.

ARCHITECTURAL ELEMENTS

Seating areas

Hot water fountains

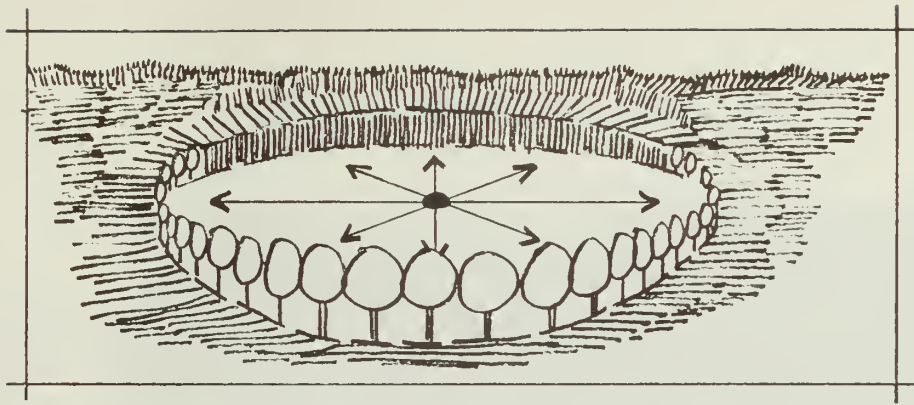

Figure 36. Enclosed Landscape Composition Sketch



Figure 37. Arlington Lawn Subunit, Looking South along Bathhouse Row, 1984
(Source: Hot Springs National Park)



Figure 38. Arlington Lawn Subunit, Looking Southwest toward Central Avenue, 1984
(Source: Hot Springs National Park)

E-1. DISPLAY SPRINGS SUBUNIT (BEHIND MAURICE BATHHOUSE)

SPATIAL STRUCTURE

Topographic relief is the primary spatial determinant. However, the small scale of the space increases the importance of architectural elements and vegetation in the spatial experience of this subunit. Spatial composition is a mix of visual enclosure and landscape details.

SPATIAL CHARACTER

While the slope of a tufa outcrop determines the spatial experience, the visual experience is oriented inwardly by architectural elements and the presence of hot water. The ephemeral effects of hot water vapors dominate the space on a cool day. The juxtaposition of smooth architectural surfaces and rough dry-laid tufa-rock walls and tufa outcrops imposes formal landscape treatment upon natural features. In a sense, this small subunit epitomizes the evolution of natural landscape to man-made landscape.

FUNCTION

This subunit primarily provides an intimate, out-of-the-way space to experience flowing hot water springs. While the water channels connecting the springs and the central collection pool were constructed, this manner of landscape treatment preserves the water in a more "natural" way than display or drinking fountains do elsewhere in the Lawn Park.

ARCHITECTURAL ELEMENTS

- Brick-paved terrace
- Concrete walkway and steps
- Dry-laid tufa-rock retaining walls
- Seating area



Figure 39. Display Springs Subunit, Looking at Seating Area, 1984
(Source: Hot Springs National Park)



Figure 40. Display Springs Subunit, Looking at Display Pool, 1984
(Source: Hot Springs National Park)

E-2. MAURICE DISPLAY SPRINGS SUBUNIT (BESIDE HALE BATHHOUSE)

SPATIAL STRUCTURE

Classification of this display springs area as a subunit was based more upon function than spatial structure, because this subunit is included spatially in the bathhouse lawn subunit between the Hale and Maurice bathhouses. Topographic relief and architectural elements combine here to form a landscape edge (boundary) between the Lawn Park and Foreground Park units and a landscape feature bounding a portion of the bathhouse lawn subunit. The display springs were also set apart because their architectural organization and function are such an anomaly in the treatment and the purpose of the bathhouse lawn subunit.

SPATIAL CHARACTER

The abrupt rise of a 14-foot tufa-rock cut slope retained by a sawed-stone masonry wall provides a strong vertical edge that complements the vertical bathhouse building walls which define two of the other three sides of this rectangular space. The architectural character of the retaining wall, terrace, drinking fountain, and hot springs enclosure contrast with the obstructed tufa-rock outcrops to provide a strong visual feature for this space. Visual attention is drawn to this composition because of its architectural form, line, color, and texture. The visible presence of a walkway, a drinking fountain, and raised terrace provide the necessary elements to invite use into the subunit.

FUNCTION

The practical functions of this subunit are to stabilize the tufa-rock cut slope and to prevent contamination of the springs while making the water available for drinking. This space also provides an outdoor gathering place for social interaction. Its development as a formal landscape space is different enough from other subunit treatments that the overall experience of Bathhouse Row is enhanced.

ARCHITECTURAL ELEMENTS

Cut-stone retaining wall

Raised terrace

Hot water drinking fountain

Enclosed hot spring



Figure 41. Maurice Display Springs Subunit, Looking from Magnolia Promenade, 1984
(Source: Hot Springs National Park)



Figure 42. Maurice Display Springs Subunit, Looking Down from Maurice Bathhouse, 1984
(Source: Hot Springs National Park)

F. TRANSITION AREA SUBUNIT

SPATIAL STRUCTURE

Topographic relief and vegetation combine in this subunit to form both a landscape edge and/or a vegetative buffer. Topographic relief is the primary spatial determinant.

SPATIAL CHARACTER

The experience of this subunit is from the outside looking in. Developed trails and visitor use areas have been excluded with the exception of the Tufa Trail, a foot trail that connects Arlington Lawn with the Grand Promenade. It is an area that resulted primarily from the construction of larger bathhouses which required cuts to be made in tufa and sandstone slopes, the cuts and fills required in constructing the Grand Promenade, and the cuts originally made to accommodate the old Arlington Hotel at the Arlington Lawn site.

FUNCTION

This subunit provides the vegetative buffer and landscape edges necessary to define the limits of other subunits and to provide a transitional space between the Lawn Park and Foreground Park units.

ARCHITECTURAL ELEMENTS

Cut-stone retaining walls

Remnants of concrete retaining walls and foundations



Figure 43. Transition Area Subunit, Area behind Buckstaff Bathhouse, 1984
(Source: Hot Springs National Park)



Figure 44. Transition Area Subunit, Area behind Ozark Bathhouse, 1984
(Source: Hot Springs National Park)

G. GRAND PROMENADE SUBUNIT

SPATIAL STRUCTURE

Spatial definition of this subunit is the result of topography and vegetation, each enclosing views to varying degrees along the walkway axis. Vegetation along and brick paving patterns on the promenade appear as a series of essentially parallel lines and elements which are seen to converge toward a point. This subunit is organized around long axial sight lines with topography and vegetation that enclose side views, and is characteristic of both focal and enclosed landscape spaces.

SPATIAL CHARACTER

The promenade is laid out along the base of Hot Springs Mountain on the upper terrace. For nearly its entire length, the promenade has a cut slope uphill and a fill slope downhill. From the Reserve Avenue entrance for some 400 feet along the promenade, the uphill slope and vegetation on each side restrict side views. There is a prominent vertical orientation to this portion of the promenade. The strength of implied space along the promenade diminishes somewhat in the area where the main entrance joins the promenade. From this point northward to the Fountain Street entrance, a series of implied spaces of varying enclosure and vista points structure the spatial experience. The mix of enclosed spaces, abutting open lawn areas and woods, vista points, brick-paving color and patterns, masonry terraces and stairways, and landscape position all combine to provide a walk with visual interest and spatial variety. This arrangement also reinforces the linear movement along the promenade with views oriented ahead and, at intervals, to each side.

FUNCTION

The promenade primarily provides a passive recreation space for walking, sitting, and social interaction. It is used more as a means to enjoy the outdoors than as a primary link in the pedestrian circulation system. As a component of the Foreground Park landscape, it physically and visually ties the various spaces along its axes together. The promenade organizes space and provides continuity to landscape development along the entire upper terrace.

ARCHITECTURAL ELEMENTS

- Brick-paved walkway
- Brick-paved terrace
- Brick and stone masonry stairways
- Seating areas

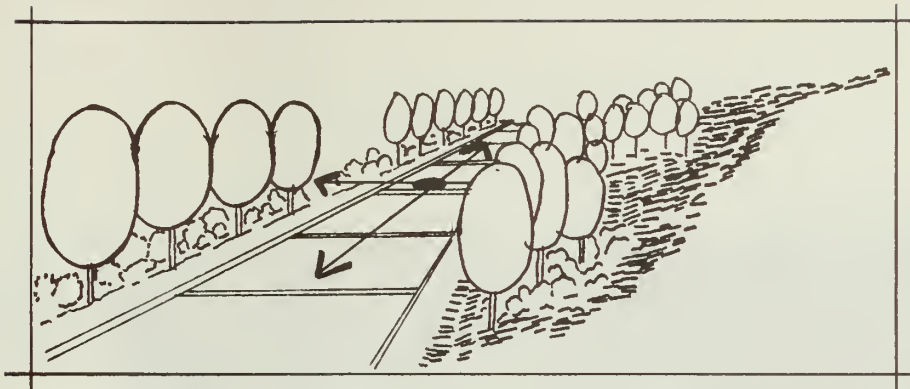

Figure 45. Focal Landscape Composition Sketch



Figure 46. Grand Promenade Subunit, Looking North at Point where Main Entrance Ties into Promenade, date unknown
(Source: Technical Information Center Photo Files, Denver Service Center, NPS, Denver)



Figure 47. Grand Promenade Subunit, Looking North along Long Axis of Promenade, 1984
(Source: Hot Springs National Park)

H. OPEN LAWN BAYS SUBUNIT

SPATIAL STRUCTURE

Vegetation is the primary spatial determinant. Expanses of open lawn areas are partially enclosed by a variety of shrubs and trees acting as side walls. Spatial composition is typical of enclosed landscape spaces.

SPATIAL CHARACTER

Because this space is mostly enclosed, a series of inwardly directed views occurs with an occasional distant view towards Central Avenue. A number of shrubs along trails and in the lawn areas visually break up the expansiveness of the open areas. There is a feeling of vertical openness.

FUNCTION

This subunit provides a transition in the landscape from the formal layout of the Grand Promenade to the more natural wooded slopes above. Trails provide a pedestrian link between the promenade and the Hot Springs Mountain trails.

ARCHITECTURAL ELEMENTS

Tufa-rock stairways

Paved trails



Figure 48. Open Lawn Bays Subunit, 1984 (Source: Hot Springs National Park)



Figure 49. Open Lawn Bays Subunit, Looking across Arlington Lawn at Open Bays from Arlington Hotel, 1984 (Source: Hot Springs National Park)

I. OPEN WOODS SUBUNIT

SPATIAL STRUCTURE

Vegetation is the primary spatial determinant since this subunit consists of a mass of trees with a relatively dense canopy. The space created is enclosed overhead and open to the sides.

SPATIAL CHARACTER

Overall, this space has a feeling of breadth contained vertically between the tree canopy and the ground. This treatment is characteristic of English landscapes where the understory has been removed. This space tends to be relatively dark and enclosed during the summer, but open in the winter. Views are focused to the open sides. Trails that traverse the canopied spaces provide the only organized element directing use of the space.

FUNCTION

This subunit provides a transition zone that works in conjunction with the open lawn bays to relate the more natural wooded slopes to the man-manipulated landscape.

ARCHITECTURAL ELEMENTS

Tufa-rock retaining walls

Tufa-rock stairways

Paved trails

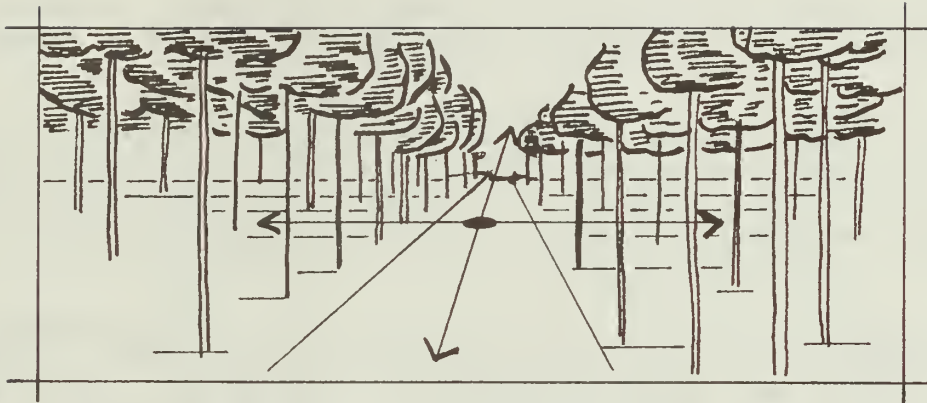

Figure 50. Canopied Landscape Composition Sketch



Figure 51. Open Woods Subunit, Looking Along Paved Trail, 1984 (Source: Hot Springs National Park)



Figure 52. Open Woods Subunit, Looking Along Unpaved Trail, 1984 (Source: Hot Springs National Park)

EVALUATION

The evaluation portion of the process consists of two steps: evaluation of historical integrity and analysis of visual accessibility of a landscape space.

The premise of the integrity portion of the landscape evaluation is that the more an existing landscape subunit meets its historically planned function with the least modification to planned arrangements of plant materials and architectural elements, then the greater the historical integrity, and resulting significance, attributable to that subunit.

Historical integrity is then a measure of the similarities between the present landscape and the extant landscapes of the 1890s and 1930s periods. Similarities were identified by comparing the Spatial Organization and Function Analysis maps for the 1890s and 1930s periods to the 1985 map. Also, the descriptive inventory of the 1985 landscape was compared to historic documentation in the Design and Development section. Analysis maps and examples of the photographic documentation used for the evaluation process are contained in the Appendix.

Relative similarities between landscape periods were quantified by rating nine factors: determinants of space, landscape composition, size of the subunit, visual enclosure, visual image, purpose of the subunit, physical remains, spatial association, and modifications. A standardized point system assigned great, some, or little integrity to each of the nine factors by subunit. The values for each subunit were then calculated and, according to total points, three historical integrity classes were determined and mapped.

The rating criteria and relative values used in quantifying landscape subunit integrity are shown on Table 1: Historical Integrity / Evaluation Rating Criteria and Score. A summary of integrity scores by key factors and subunits are shown on Table 2. Levels of integrity are defined and physical limits are shown on the Historical Integrity map.

Table Unit



Spatial Structure		Architectural Elements	
Determinants of Space	Landscape	Spatial Association	Modifications
Current spatial relationship between topography, vegetation, and architecture reflects the configuration of the historic landscape space.	The pre-1800 materials of group were tree canopies, which have continued to be a visual characteristic of the historic landscape.	Spatial relationships and associated physical elements exist today in the particular patterns that they did historically.	Free from spatial intrusions, and modifications, if any, do not compromise historical integrity of the landscape.
5	6	5	2
The hierarchy of spatial determinants which historically defined the landscape's spatial configuration continues to do so, but their overall spatial relationship has been diminished.	Subtle changes in materials but the historic character for overall space is still significant.	Some changes in the historic pattern of elements have occurred but the overall association important in identifying the historic landscape remains.	Historical spatial character and integrity are somewhat depreciated by modifications which remain subordinate to the characteristic landscape.
3	3	3	0
The spatial relationship of topography, vegetation, and architecture is so altered that the dominant historic determinant(s) of space have become subordinate in the space.	Extensive changes have been made to the historic landscape that substantially alter its visual character.	Any sense of the historic pattern of elements has been lost with the removal and/or relocation of most physical elements significant to the historic landscape.	Modifications are so dominant in the landscape subunit that spatial character and historical integrity are substantially reduced.
1	1	1	0.5

Table 2: Summary of Historical Integrity Scores and Classes by Landscape Subunit

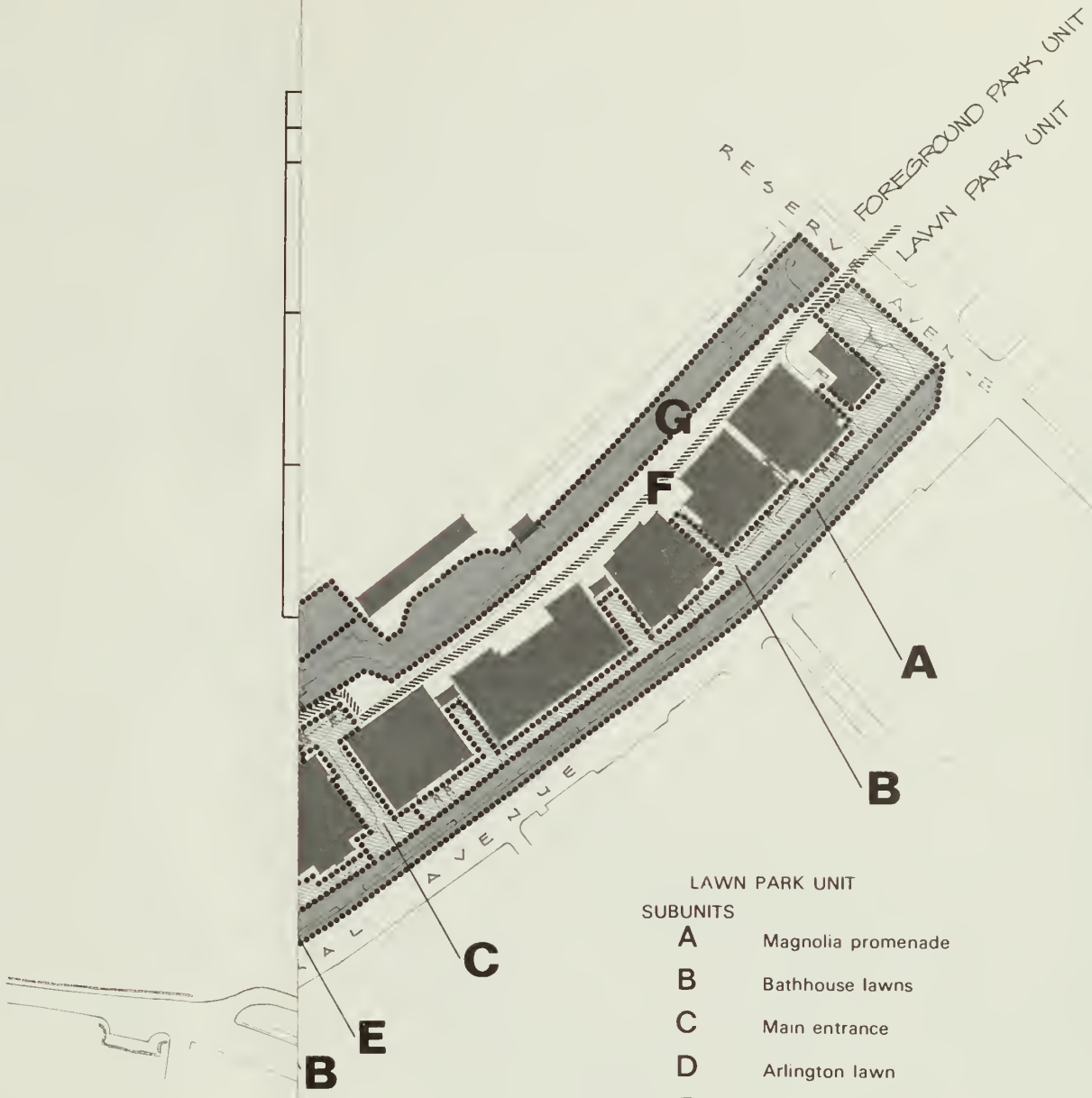

LANDSCAPE SUBUNITS	KEY FACTORS										Historical Integrity Class	
	Determinants of Space	Landscape Composition	Size of Space	Visual Enclosure	Visual Image	Purpose of Space	Physical Remains	Spatial Association	Modifications	Point Total		
Lawn Park												
Magnolia Promenade	5	5	5	5	5	5	3	5	2	40	I	
Bathhouse Lawns	5	5	5	3	3	5	3	3	0	32	II	
Main Entrance	5	3	5	5	3	5	3	3	0	32	II	
Arlington Lawn	5	5	5	5	5	5	6	5	2	43	I	
Display Springs	5	5	5	5	5	5	6	5	0	41	I	
Maurice Display Springs	5	5	5	5	5	5	6	5	2	43	I	
Foreground Park												
Grand Promenade	5	5	5	5	5	5	6	5	2	43	I	
Open Lawn Bays	5	5	5	5	5	5	6	5	2	43	I	
Open Woods	5	5	5	5	5	5	6	5	2	43	I	

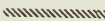

- LAWN PARK UNIT
SUBUNITS
- A Magnolia promenade
 - B Bathhouse lawns
 - C Main entrance
 - D Arlington lawn
 - E Display springs
 - F Transition area
- FOREGROUND PARK UNIT
SUBUNITS
- G Grand promenade
 - H Open lawn bays
 - I Open woods

 Boundary between lawn and foreground parks
 Subunit boundary

DESIGNED: G. JOHNSON	SUB SHEET NO.	TITLE OF SHEET HISTORICAL INTEGRITY BATHHOUSE ROW LANDSCAPE 1985	DRAWING NO. 120 25,009A
DRAWN: G. JOHNSON			PKG. NO.
TECH. REVIEW:			SHEET
DATE: 3/85			OF

HISTDRICAL INTEGRITY	
LEVEL	LANDSCAPE SUBUNIT SIGNIFICANCE
I 	EXISTING LANDSCAPE SUBUNITS CONTINUE TO MEET THEIR HISTORICALLY PLANNED FUNCTION WITH LITTLE TO NO MODIFICATION OF PLANNED ARRANGEMENTS OF PLANT MATERIALS AND ARCHITECTURAL ELEMENTS
II 	EXISTING LANDSCAPE SUBUNITS CONTINUE TO MEET THEIR HISTORICALLY PLANNED FUNCTION, HOWEVER, PLANT MATERIALS SPECIES AND LOCATIONS HAVE BEEN MODIFIED AND SOME SIGNIFICANT ARCHITECTURAL ELEMENTS HAVE BEEN REMOVED
III 	EXISTING LANDSCAPE SPACES CONTINUE TO PROVIDE A TRANSITION FROM THE LAWN PARK UNIT TO THE FOREGROUND PARK UNIT AND THEY TEND TO BE VISUALLY INCONSPICUOUS AND PHYSICALLY INACCESSIBLE

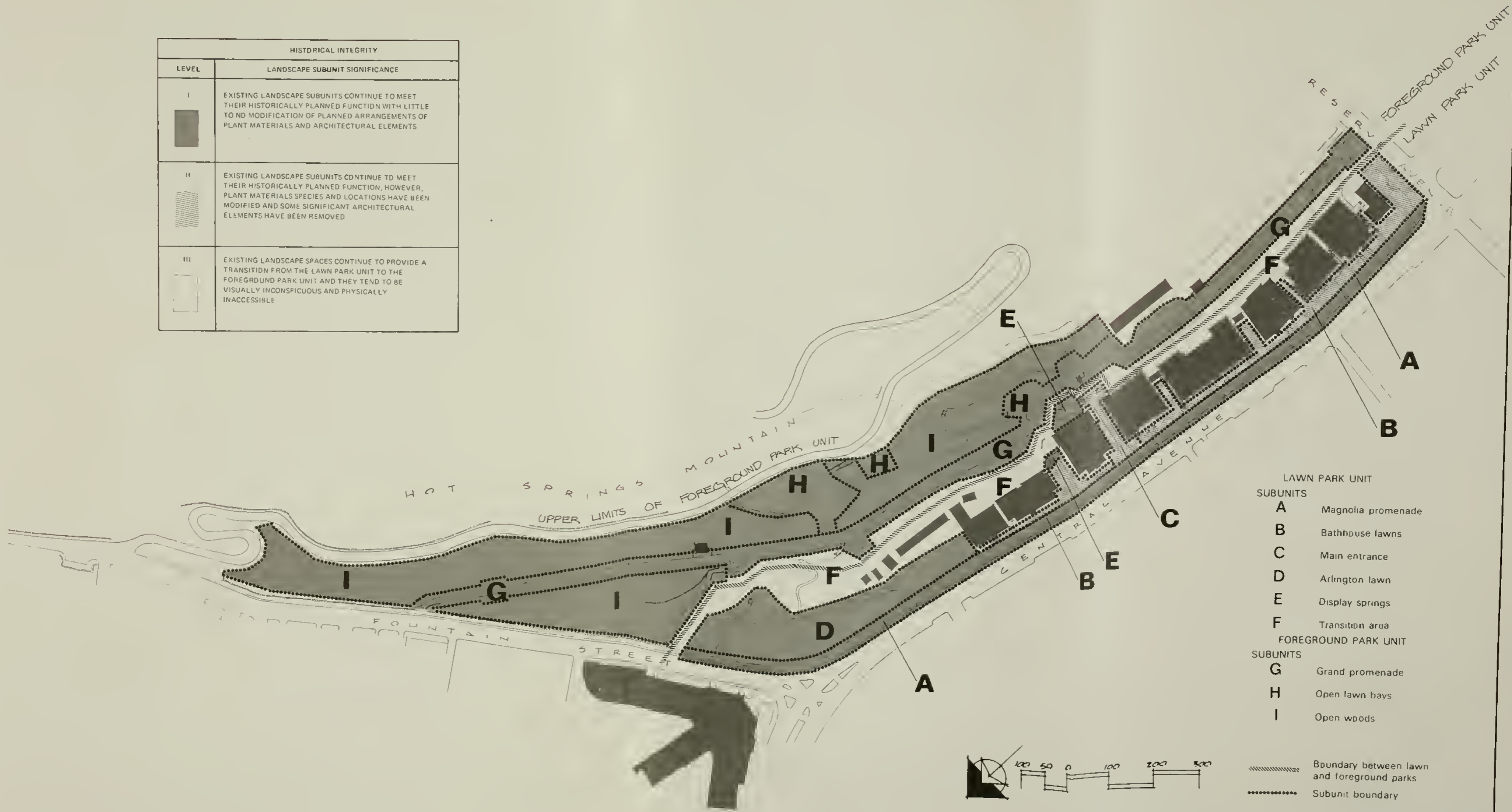

- LAWN PARK UNIT
SUBUNITS
- A Magnolia promenade
 - B Bathhouse lawns
 - C Main entrance
 - D Arlington lawn
 - E Display springs
 - F Transition area
- FOREGROUND PARK UNIT
SUBUNITS
- G Grand promenade
 - H Open lawn bays
 - I Open woods

 Boundary between lawn and foreground parks

 Subunit boundary

DESIGNED G. JOHNSON	SUB SHEET NO.	TITLE OF SHEET HISTORICAL INTEGRITY	DRAWING NO. 128
DRAWN: G. JOHNSON		BATHHOUSE ROW LANDSCAPES	25,009A
TECH. REVIEW:		1985	PKG. NO.
DATE: 3/85			SHEET
			OF

Visual accessibility is analyzed by determining the pedestrian travel routes through a particular landscape subunit and the conspicuousness of that space. Conspicuousness is considered because a subunit may be viewed from observation points at varying distances away from the subunit as well as being viewed while walking through it. The premise of the visual accessibility portion of the landscape evaluation is that the more often an existing landscape subunit is viewed and the more observation points from which the subunit can be viewed, the greater the potential visibility of modifications in the landscape subunit.

An analysis of pedestrian travel routes, observation points, viewing distances, spatial enclosure, etc., was conducted and mapped as a part of the inventory process (see Spatial Organization and Function Analysis maps in the Appendix). That information was used to develop the Visual Accessibility map that graphically represents the levels of visual accessibility for each landscape subunit. Three levels of accessibility were mapped.

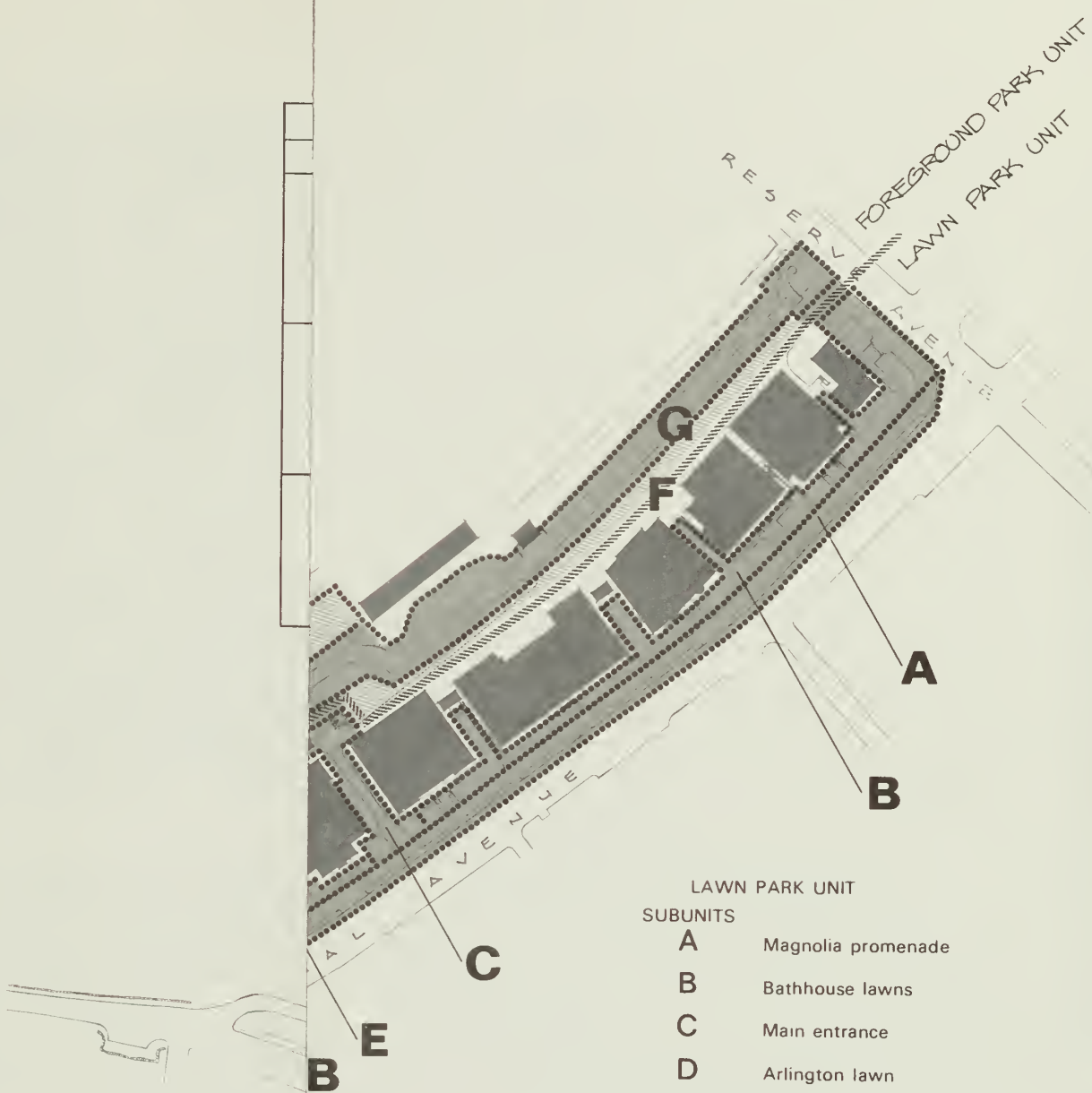

- LAWN PARK UNIT
- SUBUNITS
- A Magnolia promenade
 - B Bathhouse lawns
 - C Main entrance
 - D Arlington lawn
 - E Display springs
 - F Transition area
- FOREGROUND PARK UNIT
- SUBUNITS
- G Grand promenade
 - H Open lawn bays
 - I Open woods



- Boundary between lawn and foreground parks
- Subunit boundary

DESIGNED: G. JOHNSON	SUB SHEET NO.	TITLE OF SHEET VISUAL ACCESSIBILITY BATHHOUSE ROW LANDSCAPES 1985	DRAWING NO. <u>12B</u> <u>25,010A</u>
DRAWN: G. JOHNSON			PKG. NO.
TECH. REVIEW:			SHEET
DATE: <u>3/85</u>			<input type="checkbox"/>
			OF

VISUAL ACCESSIBILITY	
LEVEL	LANDSCAPE SUBUNIT CONSPICUOUSNESS
I	THE LANDSCAPE IS VISIBLE FROM BOTH TRAVEL ROUTES WITHIN AND FROM OBSERVATION POINTS OUTSIDE THE SUBUNIT. THEREFORE, MODIFICATIONS WITHIN THE SUBUNIT HAVE A GREATER POTENTIAL FOR BEING SEEN AND DIMINISHING HISTORICAL INTEGRITY
II	THE LANDSCAPE IS ONLY VISIBLE FROM WITHIN THE SUBUNIT. THEY TEND TO BE MORE VISUALLY ENCLOSED AND MODIFICATIONS HAVE LESS OF A POTENTIAL FOR BEING SEEN AND DIMINISHING HISTORICAL INTEGRITY
III	THESE LANDSCAPE SPACES TEND TO BE VISUALLY INCONSPICUOUS AND PHYSICALLY INACCESSIBLE. LITTLE POTENTIAL FOR MODIFICATIONS BEING SEEN EXIST IN THIS SUBUNIT

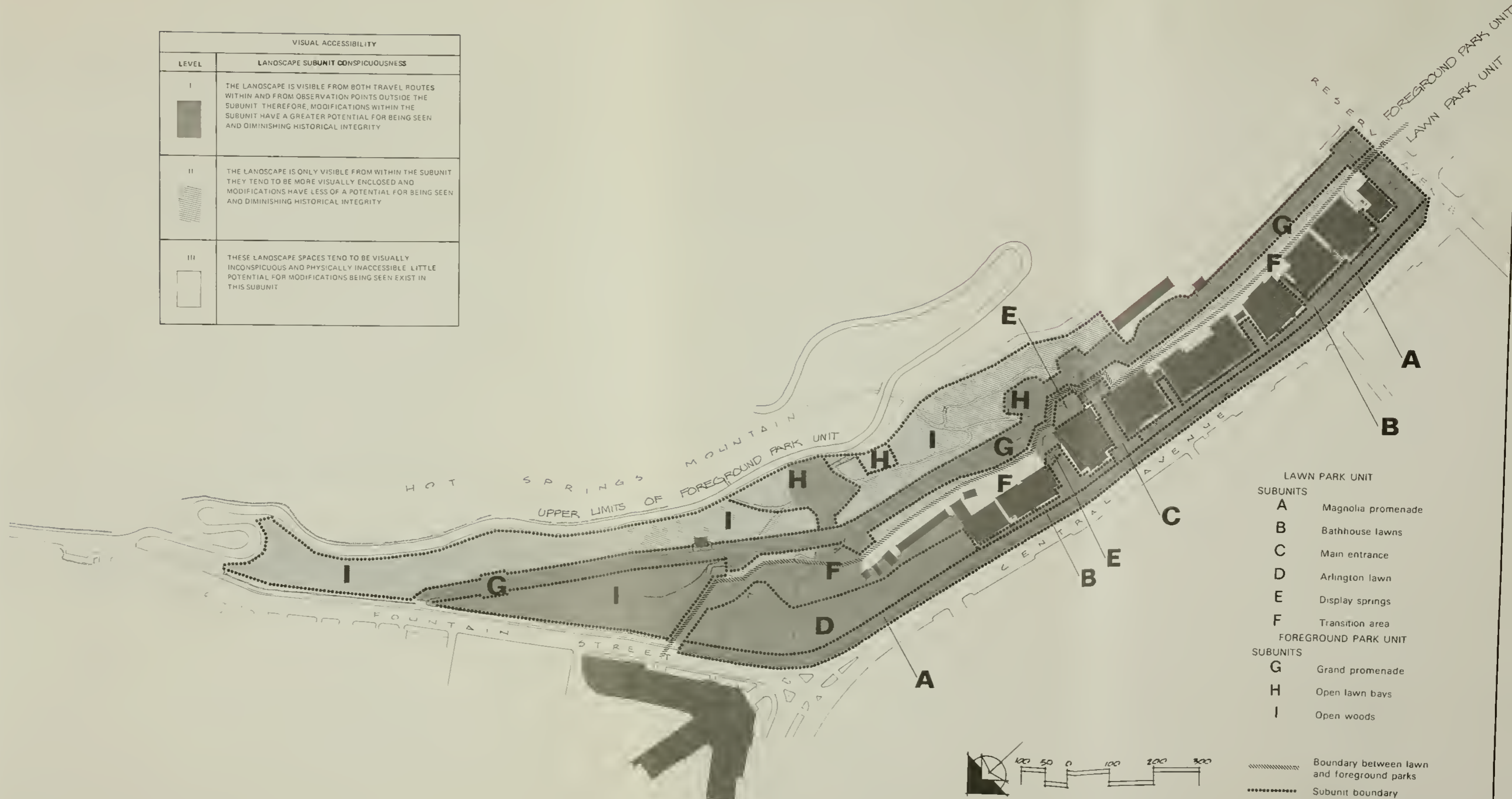

- LAWN PARK UNIT
SUBUNITS
- A Magnolia promenade
 - B Bathhouse lawns
 - C Main entrance
 - D Arlington lawn
 - E Display springs
 - F Transition area
- FOREGROUND PARK UNIT
SUBUNITS
- G Grand promenade
 - H Open lawn bays
 - I Open woods

Boundary between lawn and foreground parks (indicated by a dashed line)



Subunit boundary (indicated by a dotted line)

DESIGNED: G. JOHNSON	SUB SHEET NO.	TITLE OF SHEET VISUAL ACCESSIBILITY BATHHOUSE ROW LANDSCAPES 1985	DRAWING NO. 12B
DRAWN: G. JOHNSON			PKG. NO.
TECH. REVIEW:			SHEET NO.
DATE: 3/85			OF

MANAGEMENT CLASSES

Management classes describe the different degrees of modification allowed to the basic elements (spatial structure and character, function, and architectural elements) of the landscape subunit. Definition of management classes first involved an overlay technique that combined the maps of historic intactness and visual accessibility. The resulting composite map was used to identify areas with similar historical integrity and visual accessibility. It became apparent from the composite that landscape subunits were aggregated into three fairly distinct groupings; three management classifications were then determined for the Bathhouse Row landscape, as depicted on the Management Classes map. The most significant landscape features are found in class I, which includes portions of the Lawn Park (Magnolia Promenade, front lawn areas, and Arlington Lawn), the Foreground Park (along the Grand Promenade), and the three main entrances to the Grand Promenade. The Lawn Park and Foreground Park are significant landscape units because they were designed to highlight specific spatial relationships that have been maintained over the years, despite almost-continuous construction activity in some areas. The entrances are significant for their unique composition and style or for their architectural elements. Although the areas included in class II are less sensitive than those in class I, they are visually important. They contain unique spatial characteristics and less-imposing architectural elements, as in the case of the open lawn bays and woods adjacent to the Grand Promenade. Areas in class III are the least significant because they are generally hidden from view or lack unique elements.

Any possible modifications to the landscape as a result of adaptive use of the bathhouses, construction activities, or other management actions will be evaluated in accordance with the management classes that have been defined for the landscape subunits. In class I, no permanent alterations of landscape features by removing or introducing elements that change the historic spatial character or basic landscape elements of form, line, color, or texture will be allowed. In class II, some modification can occur if the introduced elements remain subordinate to the characteristic landscape. In class III, landscape space modifications can be dominant, but they should repeat the form, line, color, and texture of the space.

MANAGEMENT CLASS	LANDSCAPE SUBUNIT SIGNIFICANCE	ALLOWED MODIFICATION
I 	SIGNIFICANT LANDSCAPE SUBUNITS WHOSE HISTORIC SPATIAL CHARACTER, STRUCTURE, AND ARCHITECTURAL COMPONENTS ARE BASICALLY INTACT. THESE SPACES ARE PRIMARY TO EXPERIENCING THE PERIOD LANDSCAPE.	MODIFICATION OF THE SUBUNIT BY CHANGING ANY OF THE BASIC LANDSCAPE ELEMENTS (FORM, LINE, COLOR, AND TEXTURE) SHOULD NOT BE EVIDENT IN THE CHARACTERISTIC LANDSCAPE SUBUNIT. MODIFICATIONS MAY BE SEEN BUT MUST NOT ATTRACT ATTENTION.
II 	SUBUNITS THAT SERVE AS LANDSCAPE EDGES, VEGETATIVE BUFFERS, OR AREAS OF TRANSITION FROM HISTORICALLY AND VISUALLY SIGNIFICANT SUBUNITS TO LESS CONSPICUOUS SPACES.	CONTRASTS TO THE BASIC LANDSCAPE ELEMENTS CAUSED BY MODIFICATIONS MAY BE EVIDENT BUT SHOULD REMAIN SUBORDINATE TO CHARACTERISTIC LANDSCAPE SUBUNIT.
III 	VISUALLY INCONSPICUOUS SPACES CONTRIBUTING LITTLE TO THE EXPERIENCE OF THE OVERALL HISTORIC LANDSCAPE SCENE. HOWEVER, THESE SPACES MAY CONTAIN SIGNIFICANT ARCHEOLOGICAL AND/OR HISTORIC ARCHITECTURAL COMPONENTS.	MODIFICATIONS MAY BE A DOMINANT FEATURE IN THE LANDSCAPE SPACE, BUT IT SHOULD COMPLEMENT THE FORM, LINE COLOR, AND TEXTURE OF THAT SPACE.

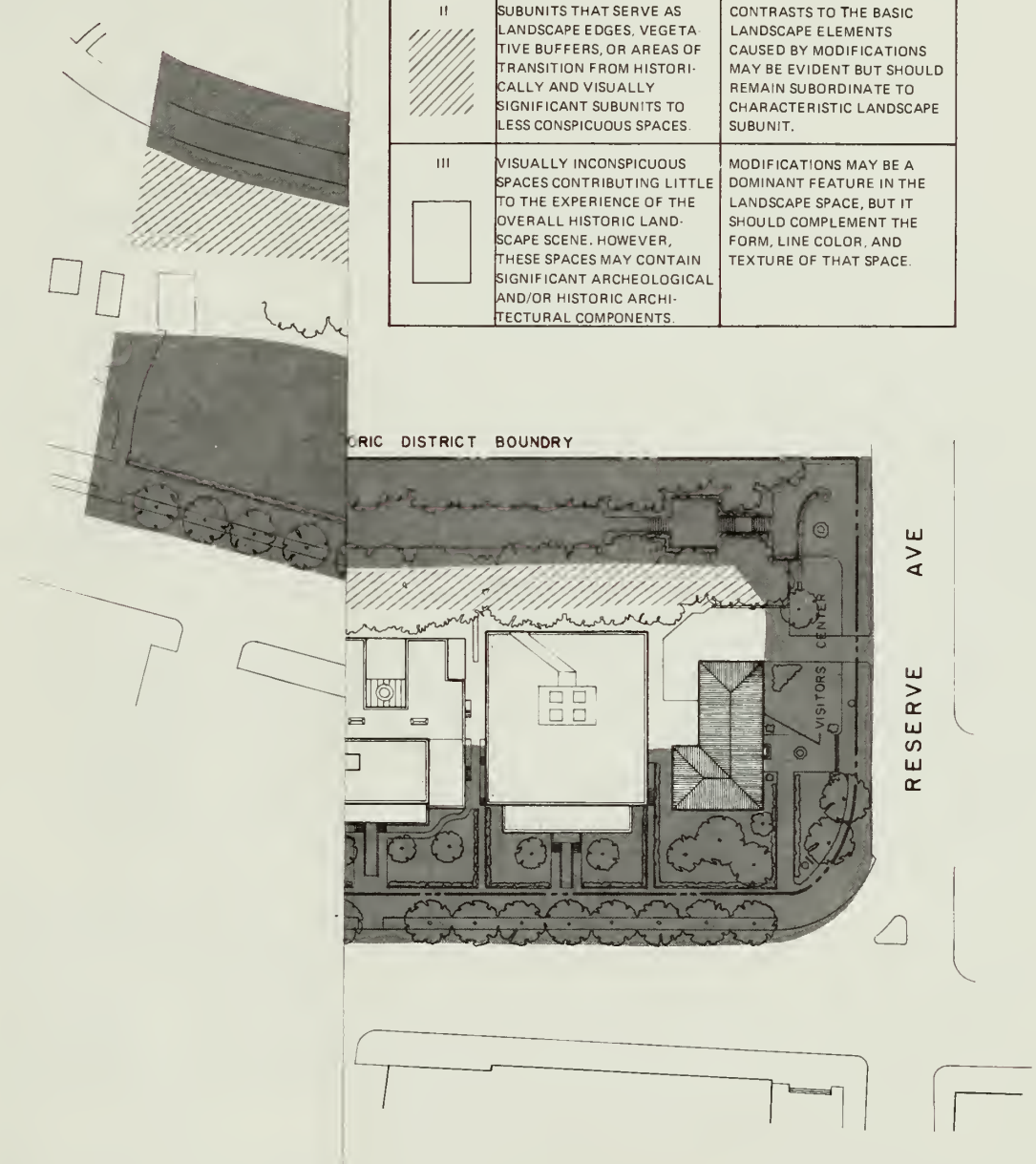



BASIC DATA
 DRAWN BY: MICHAEL PETERS 1984
 HOT SPRINGS NATIONAL PARK, ARKANSAS
 HISTORIC AMERICAN BUILDINGS SURVEY
 NATIONAL PARK SERVICE
 UNITED STATES DEPARTMENT OF THE INTERIOR

DESIGNED: G. JOHNSON
 DRAWN: G. JOHNSON
 TECH. REVIEW:
 DATE: 3/85

TITLE OF SHEET
 MANAGEMENT CLASSES
 BATHHOUSE ROW LANDSCAPE
 1985

DRAWING NO. 128
 25,011A
 PKG. NO.
 SHEET
 OF

MANAGEMENT CLASS	LANDSCAPE SUBUNIT SIGNIFICANCE	ALLOWED MODIFICATION
I 	SIGNIFICANT LANDSCAPE SUBUNITS WHOSE HISTORIC SPATIAL CHARACTER, STRUCTURE, AND ARCHITECTURAL COMPONENTS ARE BASICALLY INTACT. THESE SPACES ARE PRIMARY TO EXPERIENCING THE PERIOD LANDSCAPE.	MODIFICATION OF THE SUBUNIT BY CHANGING ANY OF THE BASIC LANDSCAPE ELEMENTS (FORM, LINE, COLOR, AND TEXTURE) SHOULD NOT BE EVIDENT IN THE CHARACTERISTIC LANDSCAPE SUBUNIT. MODIFICATIONS MAY BE SEEN BUT MUST NOT ATTRACT ATTENTION.
II 	SUBUNITS THAT SERVE AS LANDSCAPE EDGES, VEGETATIVE BUFFERS, OR AREAS OF TRANSITION FROM HISTORICALLY AND VISUALLY SIGNIFICANT SUBUNITS TO LESS CONSPICUOUS SPACES.	CONTRASTS TO THE BASIC LANDSCAPE ELEMENTS CAUSED BY MODIFICATIONS MAY BE EVIDENT BUT SHOULD REMAIN SUBORDINATE TO CHARACTERISTIC LANDSCAPE SUBUNIT.
III 	VISUALLY INCONSPICUOUS SPACES CONTRIBUTING LITTLE TO THE EXPERIENCE OF THE OVERALL HISTORIC LANDSCAPE SCENE. HOWEVER, THESE SPACES MAY CONTAIN SIGNIFICANT ARCHEOLOGICAL AND/OR HISTORIC ARCHITECTURAL COMPONENTS.	MODIFICATIONS MAY BE A DOMINANT FEATURE IN THE LANDSCAPE SPACE, BUT IT SHOULD COMPLEMENT THE FORM, LINE, COLOR, AND TEXTURE OF THAT SPACE.



BASIC DATA
 DRAWN BY MICHAEL PETERS 1984
 HOT SPRINGS NATIONAL PARK, ARKANSAS
 HISTORIC AMERICAN BUILDINGS SURVEY
 NATIONAL PARK SERVICE
 UNITED STATES DEPARTMENT OF THE INTERIOR

DESIGNED: G. JOHNSON	SUB SHEET NO.	TITLE OF SHEET MANAGEMENT CLASSES BATHHOUSE ROW LANDSCAPE 1985	DRAWING NO. 128 25,011A
DRAWN: G. JOHNSON			PKG. NO.
TECH. REVIEW:			SHEET
DATE: 3/85			OF

COMPATIBILITY ASSESSMENT

Having become familiar with the historical significance and spatial characteristics of each landscape subunit, it becomes a relatively simple task for an evaluator to determine the potential compatibility of a proposed modification to a landscape subunit. The appearance of introduced elements or modifications to significant historic components in each landscape subunit can be determined by considering five factors.

1. Scale compatibility: How similar in size and scale are the proposed modifications with the landscape elements of the subunit? Would they dominate the existing landscape?
2. Landscape setting compatibility: How visually compatible would proposed modifications be with the visual characteristics (size of space, visual enclosure, and visual image) of the subunit?
3. Foreground screening potential: Are there apparent opportunities in the landscape subunit to generally screen proposed modifications from view with existing landforms, vegetation, or architectural elements?
4. Background screening potential: Are there sufficient topographic relief, vegetation height, or spatial enclosure to generally prevent the proposed modifications from being silhouetted against architectural elements or vegetative backgrounds or partially silhouetted above landscape skylines?
5. Historical integrity compatibility: Would proposed modifications diminish the landscape subunit's integrity by altering the arrangement of associated site structures and elements, thus changing the character of the place; by combining incompatible materials; or by removing physical elements which convey the qualities that evoke a historic sense of past periods for which the landscape is significant?

With these five considerations in mind, specific proposed projects (modifications) can be evaluated using a contrast/alteration rating system which measures the degree of alteration to historic resources and/or the visual contrast between the proposed modifications and the Bathhouse Row landscape. This rating score will then be compared with allowable levels of alteration and contrast for the appropriate management class. The comparison will determine if mitigation is required to reduce visual and resource impacts.

The process first segregates a landscape into its major spatial-determinant features (topography, vegetation, architectural elements), and each feature, in turn, into its basic elements (integrity, form, line, color, texture). Each element has been assigned a weighted value based on its significance in the landscape (integrity = 5, most important; to texture = 1, least important).

The contrast/alteration rating is developed by comparing the proposed modification to existing conditions. Each element of the modification is compared to each element of the features according to the degree of visual contrast or physical alteration between them (3 = strong, 2 = moderate, 1 = weak, 0 = none). The element value multiplied by the degree of contrast/alteration indicates the magnitude of visual and integrity impact. For example, the form (4) of a proposed information kiosk might have a moderate (2) contrast when compared to the flat topography of the bathhouse lawns. Therefore, the contrast between the form of topography and of the kiosk would produce a contrast/alteration rating of 8 (4x2=8). This process would be repeated until each of the five elements of each feature (topography, vegetation, and architectural elements) were compared to the elements of the proposed modification.

Contrast/Alteration Rating Process

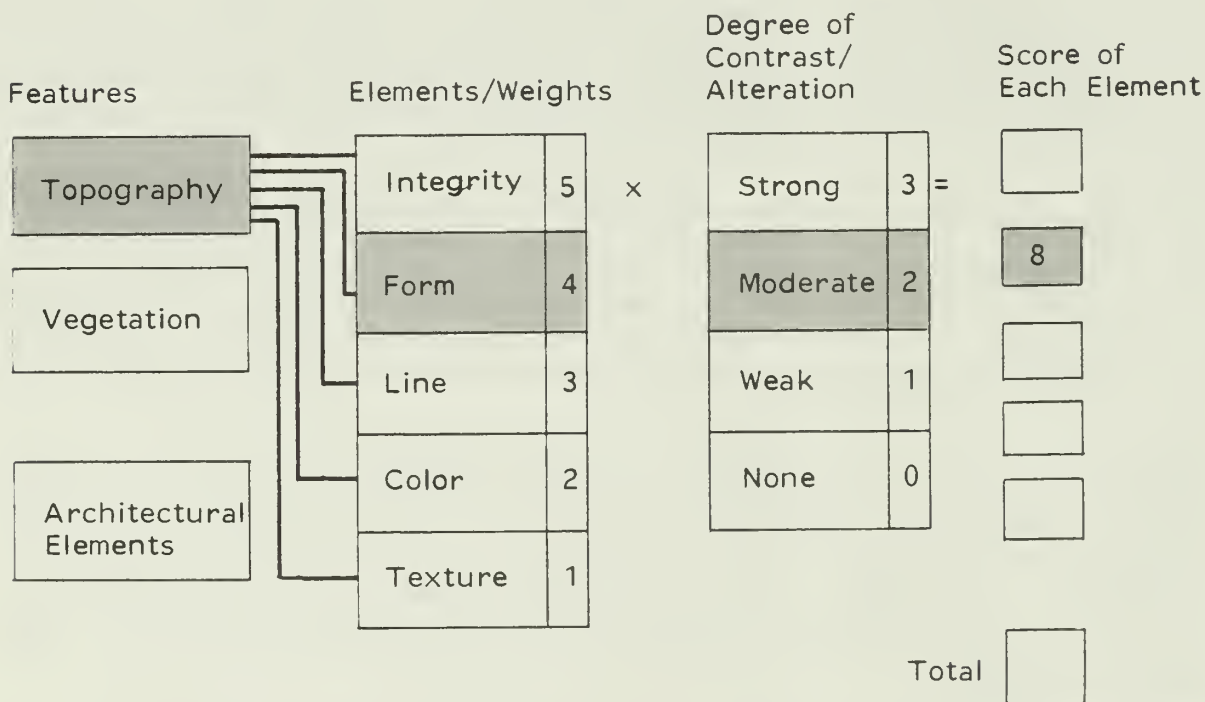



The total contrast/alteration score which results from this rating process is then used to define the overall contrast by finding the range of points that the score falls within, according to the following categories:





1. Contrast can be seen but does not attract attention and little, if any, change in historical integrity occurs (0-20 points: Management Class I).
2. The modification attracts attention and begins to dominate, but the overall historical character and most significant architectural elements are retained (21-35 points: Management Class II).
3. The modification demands attention and will not be overlooked by the average observer, and historical integrity is greatly diminished (35-45 points: Management Class III).





The contrast/alteration rating score quickly reveals the visual and integrity impacts of a particular modification on existing features and respective elements. The category's allowable contrast and management class is then compared to the management class assigned to the subunit in which the modification will occur to determine if the contrast is acceptable. If the proposed modification exceeds the management class's allowable contrast, then a National Park Service management decision will be made to (1) redesign, (2) abandon or reject, or (3) proceed, but with mitigation measures stipulated to reduce critical impacts.

APPENDIX

The following representative photographs and Spatial Organization and Functional Analysis maps for the 1890s, 1930s, and 1985 were used in conjunction with Table 1. Historical Integrity/Evaluation Rating Criteria and Score and Table 2. Summary of Historical Integrity Scores and Classes by Landscape Subunit, to quantify historical integrity of the present, 1985, landscape.

- VIEWER**
-  CARRIAGE
 -  PEDESTRIAN
 -  OBSERVATION POINT

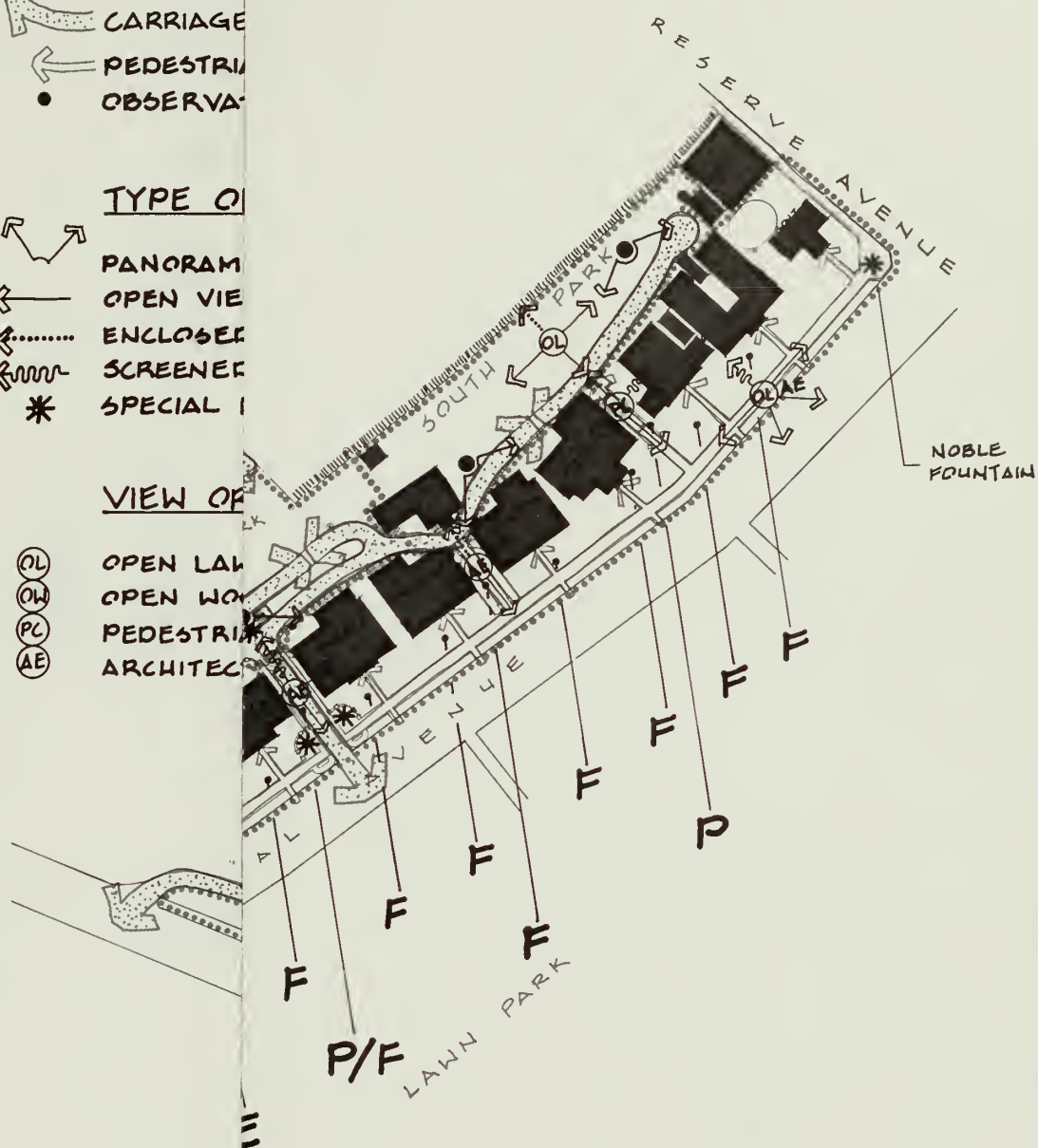

- TYPE OF VIEW**
-  PANORAMIC
 -  OPEN VIEW
 -  ENCLOSED
 -  SCREENED
 -  SPECIAL

- VIEW OF**
-  OPEN LANDSCAPE
 -  OPEN WORKS
 -  PEDESTRIAN
 -  ARCHITECTURE





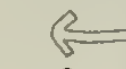

PREPARED G. JOHNSON DESIGNED G. JOHNSON DRAWN	TITLE OF DRAWING SPATIAL ORGANIZATION & FUNCTION ANALYSIS BATHHOUSE ROW LANDSCAPE 1890'S	DRAWING NO. 12B 25,006A PKG NO. _____ SHEET _____ OF _____
CHECKED 6/85 DATE		



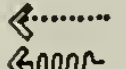
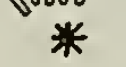

VIEWER LOCATION

-  CARRIAGE ROADS
-  PEDESTRIAN TRAVEL ROUTES
-  OBSERVATION POINTS



TYPE OF VIEW

-  PANORAMIC VIEW
-  OPEN VIEW
-  ENCLOSED VIEW
-  SCREENED VIEW
-  SPECIAL FEATURE

VIEW ORIENTATION

-  OPEN LAWNS
-  OPEN WOODS
-  PEDESTRIAN CORRIDOR
-  ARCHITECTURAL ELEMENTS

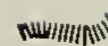
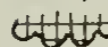
LANDSCAPE EDGES

-  TOPOGRAPHIC
-  VEGETATIVE - CLOSED SIDES
-  VEGETATIVE - OPEN SIDES
-  ARCHITECTURAL

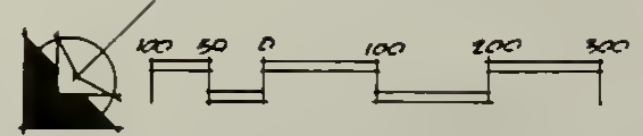
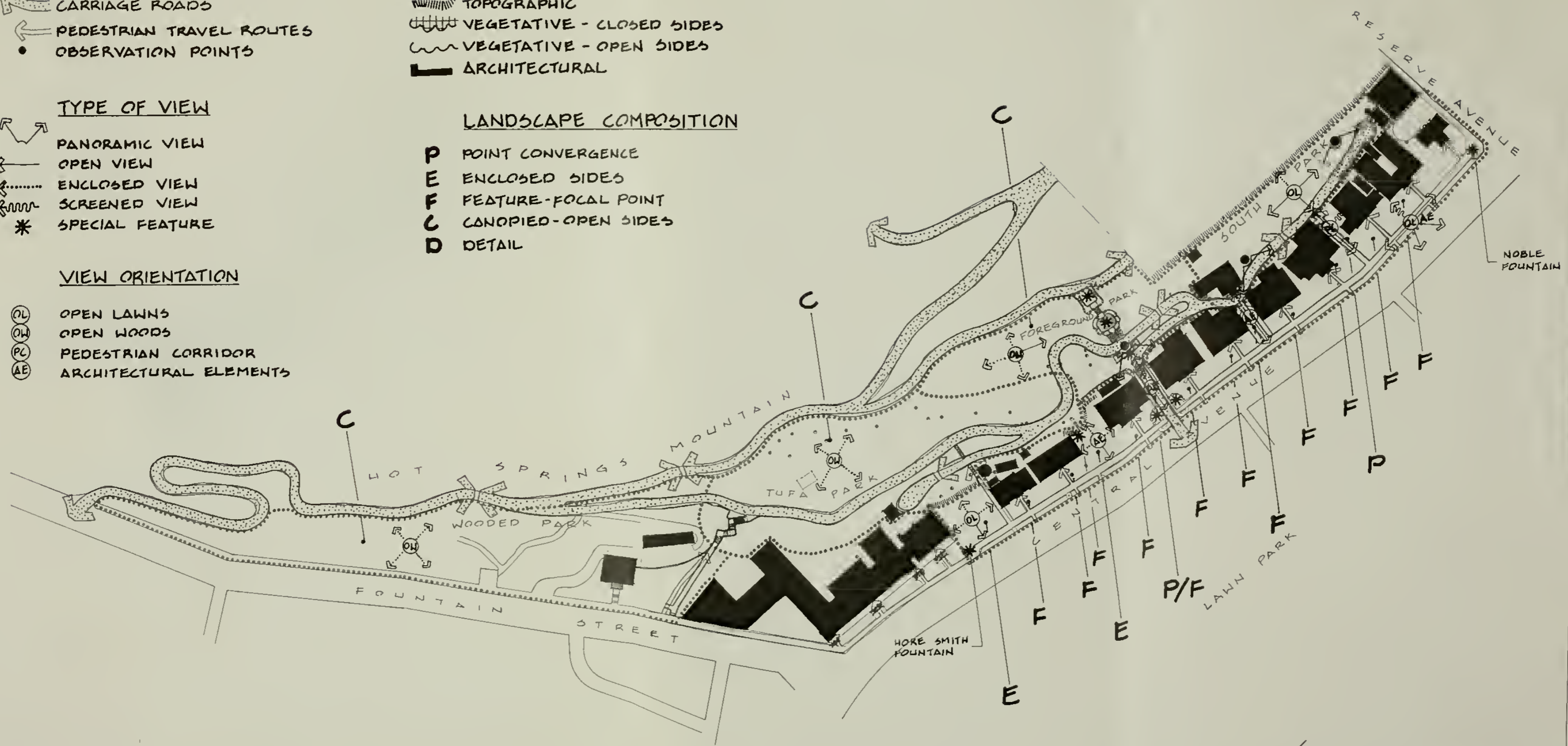

LANDSCAPE COMPOSITION

- P** POINT CONVERGENCE
- E** ENCLOSED SIDES
- F** FEATURE-FOCAL POINT
- C** CANOPIED-OPEN SIDES
- D** DETAIL







PREPARED G. JOHNSON DESIGNED G. JOHNSON DRAWN	TITLE OF DRAWING SPATIAL ORGANIZATION & FUNCTION ANALYSIS BATHHOUSE ROW LANDSCAPE 1890'S	DRAWING NO 128 25,006A PKG NO SHEET OF
CHECKED 6/85 DATE		

VIEW

-  CARRIAGEWAY
-  PEDESTRIAN
-  OBSERVATION POINT

TYPE

-  PANORAMA
-  OPEN VIEW
-  ENCLOSED VIEW
-  SCREENED VIEW
-  SPECIAL VIEW

VIEW

-  OPEN LANDSCAPE
-  OPEN WATER
-  PEDESTRIAN
-  ARCHITECTURAL

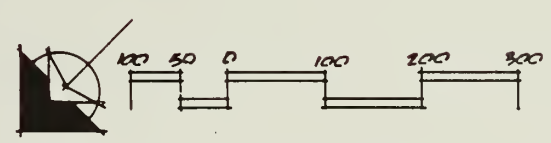
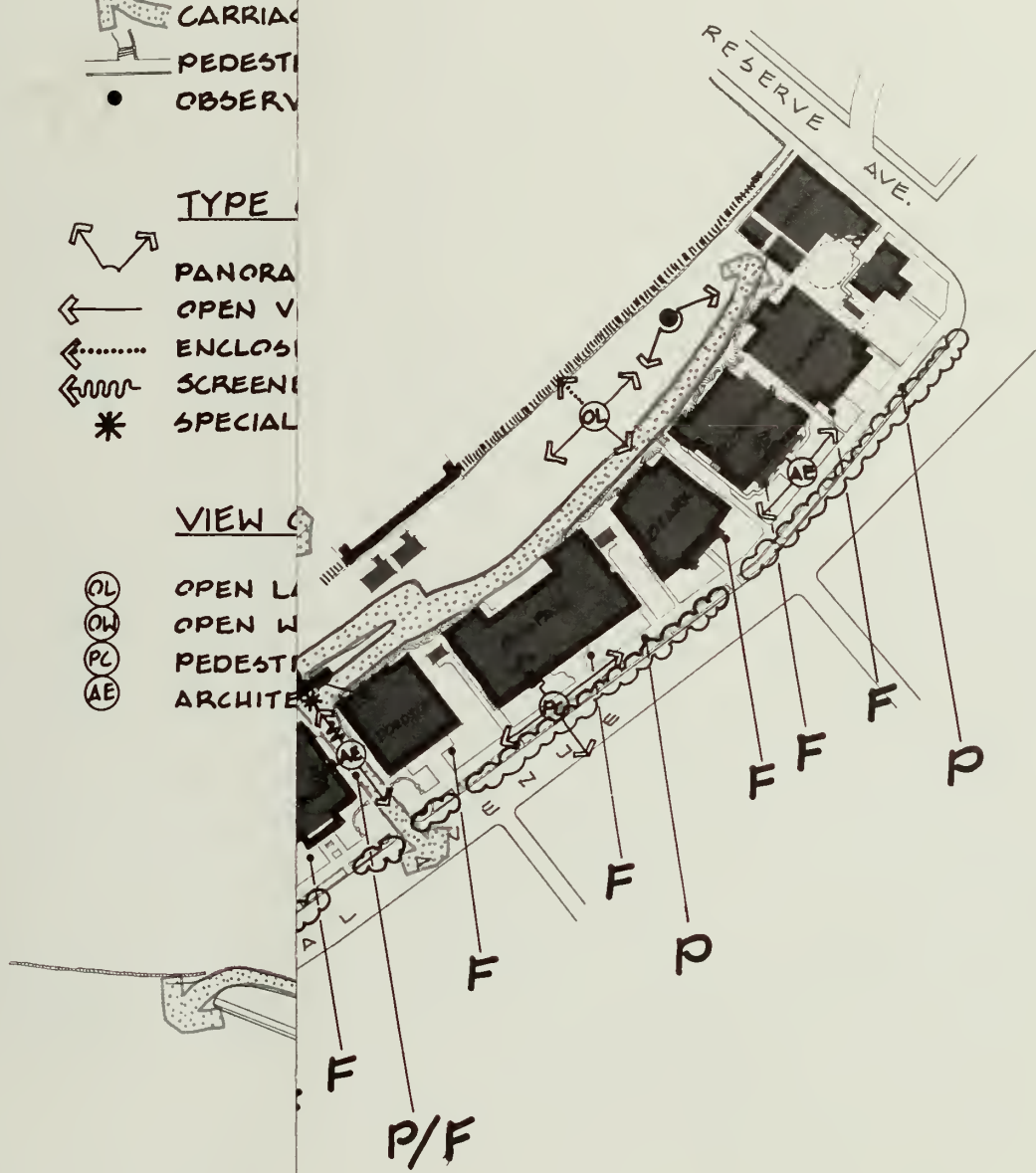



DESIGNED: G. JOHNSON	SUB SHEET NO.	TITLE OF SHEET SPATIAL ORGANIZATION & FUNCTION ANALYSIS	DRAWING NO. 128
DRAWN: G. JOHNSON		BATHHOUSE ROW LANDSCAPE	25,007
TECH. REVIEW:		EARLY 1930'S	PKG. NO. <input type="text"/>
DATE: 3/85			SHEET <input type="text"/>
			OF <input type="text"/>

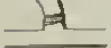
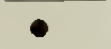

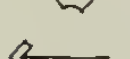
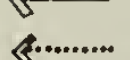
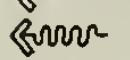

VIEWER LOCATION

-  CARRIAGE ROADS
-  PEDESTRIAN TRAVEL ROUTES
-  OBSERVATION POINTS



TYPE OF VIEW

-  PANORAMIC VIEW
-  OPEN VIEW
-  ENCLOSED VIEW
-  SCREENED VIEW
-  SPECIAL FEATURE

VIEW ORIENTATION

-  OPEN LAWNS
-  OPEN WOODS
-  PEDESTRIAN CORRIDOR
-  ARCHITECTURAL ELEMENTS

LANDSCAPE EDGES

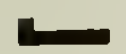
-  TOPOGRAPHIC
-  VEGETATIVE - CLOSED SIDES
-  VEGETATIVE - OPEN SIDES
-  ARCHITECTURAL

LANDSCAPE COMPOSITION

- P** POINT CONVERGENCE
- E** ENCLOSED SIDES
- F** FEATURE-FOCAL POINT
- C** CANOPIED-OPEN SIDES
- D** DETAIL



DESIGNED G. JOHNSON	SUB SHEET NO.	TITLE OF SHEET SPATIAL ORGANIZATION & FUNCTION ANALYSIS	DRAWING NO. 128
DRAWN G. JOHNSON		BATHHOUSE ROW LANDSCAPE	PKG. NO.
TECH. REVIEW		EARLY 1930'S	SHEET
DATE 3/85			OF

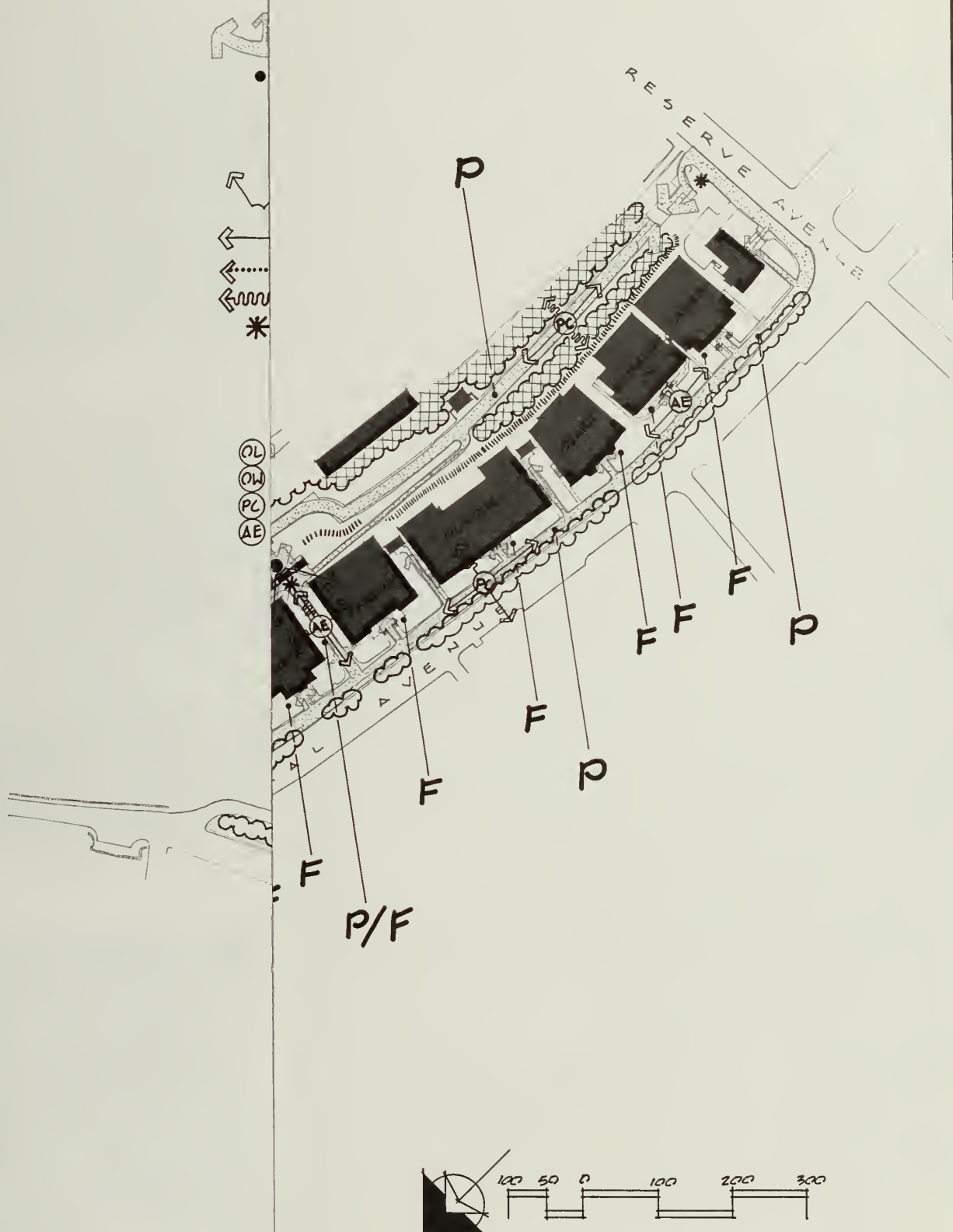





DESIGNED: G. JOHNSON	SUB SHEET NO.	TITLE OF SHEET SPATIAL ORGANIZATION & FUNCTION ANALYSIS	DRAWING NO. 128
DRAWN: G. JOHNSON		BATHHOUSE ROW LANDSCAPE	25,008
TECH. REVIEW:		1985	PKG. NO. <input type="checkbox"/>
DATE: 3/85			SHEET <input type="checkbox"/>
			OF <input type="checkbox"/>

VIEWER LOCATION

-  PEDESTRIAN TRAVEL ROUTES
- OBSERVATION POINTS



TYPE OF VIEW

-  PANORAMIC VIEW
-  OPEN VIEW
-  ENCLOSED VIEW
-  SCREENED VIEW
- * SPECIAL FEATURE

VIEW ORIENTATION

- ⊙ OL OPEN LAWNS
- ⊙ OW OPEN WOODS
- ⊙ PC PEDESTRIAN CORRIDOR
- ⊙ AE ARCHITECTURAL ELEMENTS

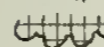
LANDSCAPE EDGES

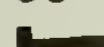
-  TOPOGRAPHIC
-  VEGETATIVE - CLOSED SIDES
-  VEGETATIVE - OPEN SIDES
-  ARCHITECTURAL

LANDSCAPE COMPOSITION

- P POINT CONVERGENCE
- E ENCLOSED SIDES
- F FEATURE-FOCAL POINT
- C CANOPIED-OPEN SIDES
- D DETAIL

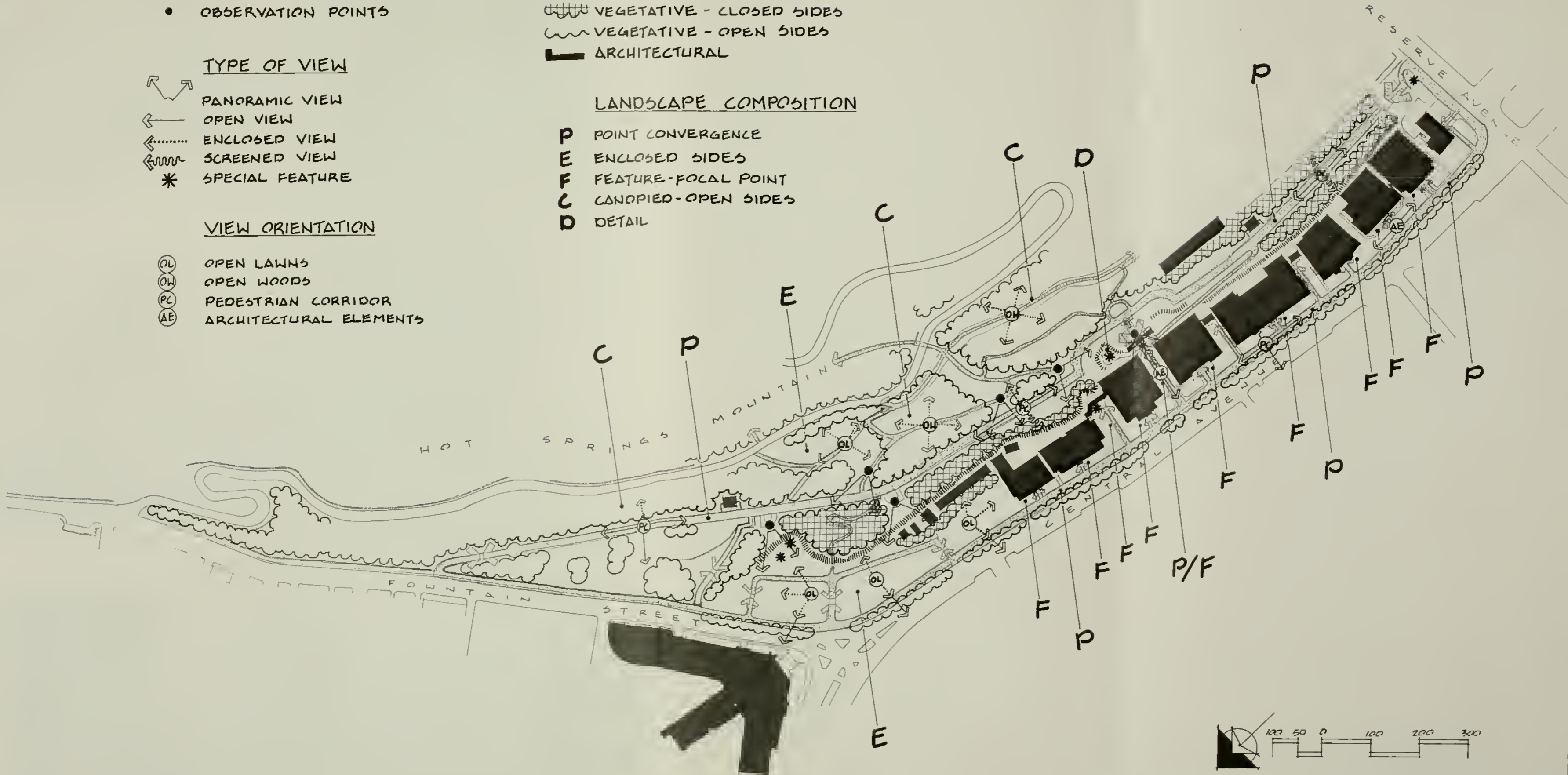

DESIGNED G. JOHNSON	SUB SHEET NO.	TITLE OF SHEET SPATIAL ORGANIZATION & FUNCTION ANALYSIS	DRAWING NO. 128
DRAWN: G. JOHNSON		BATHHOUSE ROW LANDSCAPE 1985	PKG. NO. SHEET
TECH REVIEW:			OF
DATE: 3/85			



MAGNOLIA PROMENADE AND BATHHOUSE LAWNS
Circa 1894-95



Early 1900's



Mid-1920's



Circa 1935



1984



MAIN ENTRANCE

1905



Circa 1915-1916



1952



1984



MAIN ENTRANCE
Exedra Area

Late 1890's



After 1915



1984



ARLINGTON LAWN

Late 1920's



1984



MAURICE SPRINGS

1898



After 1903



1984



DISPLAY SPRINGS

Date unknown



1952



1983



1984



THE NOBLE FOUNTAIN

Early 1900's



Late 1890's



1984



1984



GRAND PROMENADE

1930's



1930's



1984



Circa 1959



1984



GRAND PROMENADE RESERVE AVENUE ENTRANCE

1938



1984



PAVILION / BANDSTAND

1935



1935-1938



1984



OPEN LAWN BAYS

1930



1984

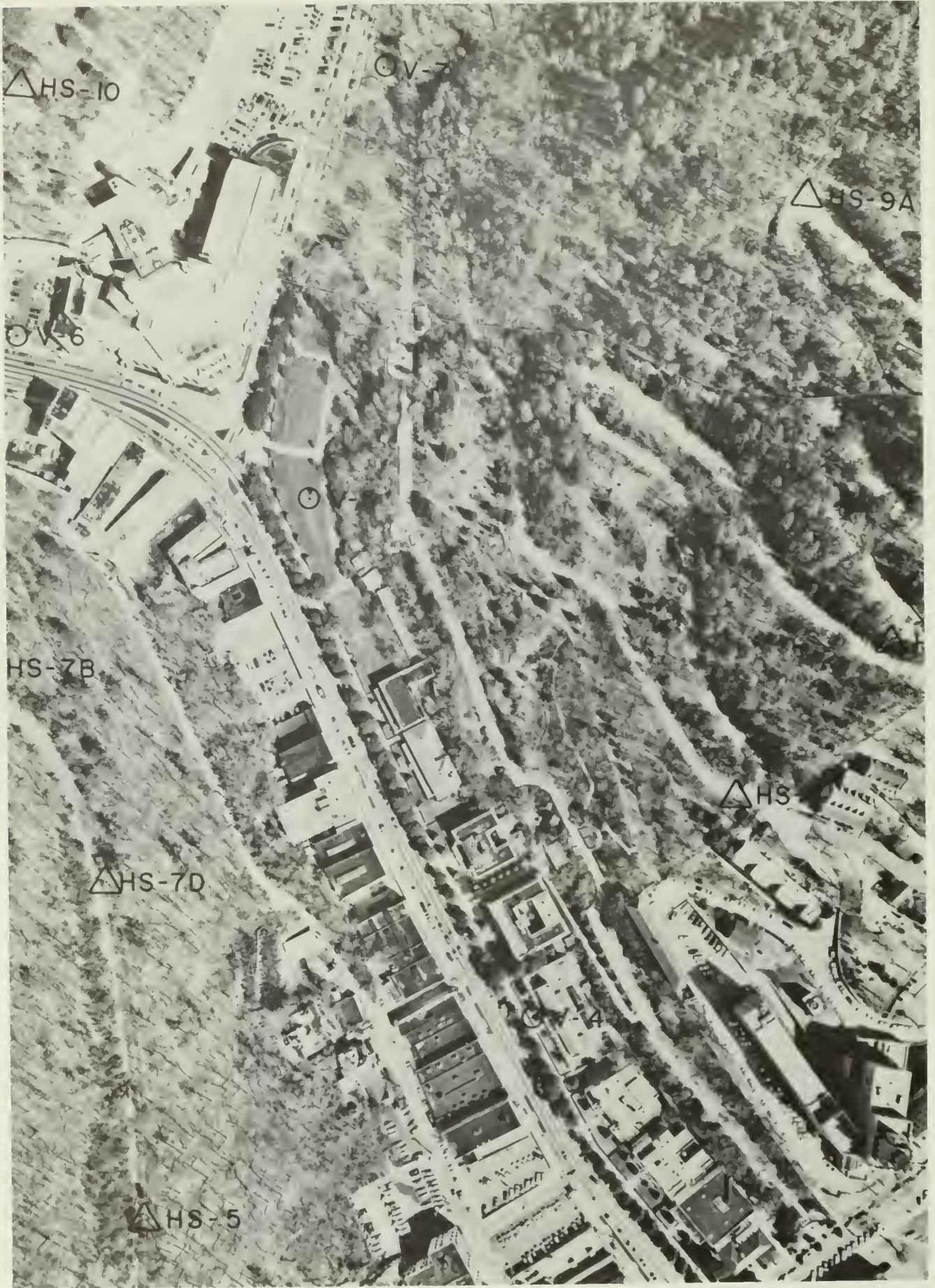

AERIAL BATHHOUSE ROW 1974

SELECTED REFERENCES

BOOTH, NORMAN K.

1983 Basic Elements of Landscape Architectural Design. New York, NY: Elsevier Science Publishing Co., Inc.

DE CHIARA, JOSEPH AND KOPPELMAN, LEE E.

1978 Site Planning Standards. New York, NY: McGraw-Hill Book Co.

FAVRETTI, RUDY J. AND FAVRETTI, JOY PUTMAN

1978 Landscapes and Gardens for Historic Buildings. Nashville, TN: American Association for State and Local History.

NEWTON, NORMAN T.

1974 Design on the Land. Cambridge, Mass: The Belknap Press of Harvard University Press.

SPREIREGEN, PAUL D.

1965 Urban Design: The Architecture of Towns and Cities. New York, NY: McGraw-Hill Book Co.

U.S. DEPARTMENT OF AGRICULTURE, FOREST SERVICE

1968 "Forest Landscape Description and Inventories--A Basis for Land Planning and Design," by R. Burton Litton, Jr. Pacific Southwest Forest and Range Experiment Station.

1978 "A Landscape Inventory Framework: Scenic Analyses of the Northern Great Plains," by R. Burton Litton, Jr. and Robert J. Tetlow. Pacific Southwest Forest and Range Experiment Station.

U.S. DEPARTMENT OF THE INTERIOR, BUREAU OF LAND MANAGEMENT

1980 "Visual Resource Management Program." Washington, D.C.

U.S. DEPARTMENT OF THE INTERIOR, NATIONAL PARK SERVICE

1972 "Plants / People / and Environmental Quality," by Gary O. Robinette. Washington, D.C.

1973 "Hot Springs National Park, Aerial Photographs 1-1 through 1-7." Denver, CO: Denver Service Center.

1984 "Cultural Landscapes: Rural Historic Districts in the National Park Service," by Robert Z. Melnick. Washington, D.C.

1985 "Historic Grounds and Structures: An Interim Report on Bathhouse Row," by Diane Rhodes. Denver, CO: Denver Service Center. On file at Hot Springs National Park.

LIST OF PREPARERS/CONSULTANTS

PREPARERS

Roger Brown, Project Coordinator, Denver Service Center (DSC)

Gary Johnson, Landscape Architect, DSC

Diane Rhodes, Researcher, DSC

CONSULTANTS

Earl Adams, Chief, Division of Interpretation, Hot Springs National Park

Bill Hall, Landscape Architect, Arkansas Historic Preservation Program

Diane Jung, Survey Historian, Division of History, Southwest Regional Office (SWRO)

Wilson Stiles, Architectural Historian/Arkansas State Historic Preservation Officer

Barry Sulam, Regional Historic Architect, Division of Conservation, SWRO

Julie Vosmik, Architectural Historian, Arkansas Historic Preservation Program

Melody Webb, Chief, Division of History, SWRO



PU