



Digitized by the Internet Archive
in 2013





HISTORIC PRESERVATION HANDBOOK



DEPARTMENT OF
HISTORIC PRESERVATION

LIBRARY

GA
N200. P6
M1
1974
P9



UNIV. OF GEORGIA LIBRARIES



HISTORIC PRESERVATION HANDBOOK

RECEIVED
A GUIDE FOR VOLUNTEERS

OCT 04 1978

HISTORIC SITES SURVEY
HISTORIC PRESERVATION SECTION
OFFICE OF PLANNING AND RESEARCH
DEPARTMENT OF NATURAL RESOURCES

DOCUMENTS
UGA LIBRARIES

INTRODUCTION

As more and more Georgia citizens and public officials become concerned with maintaining the character and integrity of their surroundings, they have begun to participate actively in the historic preservation movement. This Handbook is designed to help. It is also designed to acquaint the Georgia public with the various programs and activities centered around preservation taking place in our State. First published in 1971, this Handbook has gone through several editions and been distributed widely throughout the United States.

In 1966, the United States Congress passed the Historic Preservation Act to “. . . maintain a national register of districts, sites, buildings, structures, and objects significant in American history, architecture, archaeology and culture.” Georgia actively participates in the National Register program and in part relies on volunteers and professional people throughout the State to help. Leadership in this work previously provided by the Georgia Historical Commission is now in the hands of the Historic Sites Survey Unit, Historic Preservation Section, Office of Planning and Research, Department of Natural Resources.

In accordance with the reorganization plan of Governor Jimmy Carter, the Commission, under the Secretary of State, was abolished and the staff and responsibilities were transferred to the Department of Natural Resources and divided between the Office of Planning and Research and the Division of Parks and Historic Sites. The responsibilities for the National Register Program are carried out by the Historic Sites Survey staff of the Historic Preservation Section while the historic research, centered around State owned sites and sites under consideration for State ownership is carried out by the Historical Analysis Unit of the Historic Preservation Section. The State owned sites formerly held by the Georgia Historical Commission were placed in the hands of the Historic Sites Operations Section, Division of Parks and Historic Sites.

In July of 1972, Governor Carter created the Georgia Heritage Trust to identify, acquire, develop, and protect vital elements of our heritage on a state level in conjunction with the already established activities of the Historical Commission. Georgians from throughout the State have been asked to participate in this program by calling attention to sites that need state governmental attention and protection. This Handbook is designed to help in this program as well as in National Register work.

We hope this Handbook will provide further impetus to local groups and organizations in their preservation work and to the newly formed Georgia Trust for Historic Preservation, a non-profit, statewide membership corporation which will assume sponsorship of the annual Georgia preservation conferences which were begun in 1969. The Georgia Trust will also provide leadership on the state level similar to that provided by the National Trust for Historic Preservation for the entire country.

This Handbook has represented a great deal of time and thought by the Historic Sites Survey Staff with the hope that it will be a useful tool for preservation activities on all levels in the State.

We would greatly appreciate your thoughts and suggestions for future editions.

B - 517

DEDICATION

This edition of the Handbook is gratefully dedicated to Mary Gregory Jewett, without whose experience and expertise it could not have been accomplished and to William R. Mitchell, Jr., whose first editions had paved the way for this greatly expanded edition.

To both these preservationists we would like to say thanks, from us and all of Georgia.

TABLE OF CONTENTS

CHAPTER I:	Preservation in Georgia - A Chronology	1
CHAPTER II:	Organizations and Individuals	4
	A list of those people and groups who can provide help	
CHAPTER III:	The National Register Program	8
	What is it?	
	Criteria for Evaluation	
	Inventory - Nomination Forms	
	Properties on the National Register	
CHAPTER IV:	The Historical Survey in Georgia	31
	The Georgia Scene	
	Architectural - Historical Survey - a Method	
	Structural and Site Survey Form	
	Archeology in Georgia	
CHAPTER V:	Sources for Research	38
CHAPTER VI:	Styles of Architecture in Georgia 1733 to Early 20th Century	41
	Colonial	
	Plantation Plain	
	Federal	
	Regency	
	Greek Revival	
	Gothic Revival	
	Italian Villa	
	Octogan	
	High Victorian:	
	Romanesque Revival	
	Second Empire	
	Queen Anne	
	Eastlake	
	Stick and Shingle	
	Early 20th Century	
CHAPTER VII:	Preservation, Restoration, Reconstruction and Rehabilitation	54
	Restoration Philosophy	
	Guidelines for Beginning a Restoration	
	Some Notes on the Treatment of Details	
CHAPTER VIII:	Glossary of Architectural Terms	65
CHAPTER IX:	Pictorial Glossary	71
CHAPTER X:	Publications	81

State Historic Preservation Officer
and
Chief, Historic Preservation Section

Jackson O'Neal Lamb

Historic Sites Survey:

Coordinator, National Register Program
Architectural Historian
Preservation Planner
Photographer
Secretary to the Staff
State Archeologist

Carole A. Summers
Elizabeth Z. Macgregor
Jean K. Buckley
David Kaminsky
Cynthia J. Smith
Dr. Lewis H. Larson, Jr.

THE GEORGIA REVIEW BOARD

Dr. James C. Bonner, History, Milledgeville
Dr. J. Turner Bryson, Citizen Member, Washington
Arnall T. Connell, Architecture/Planner, Atlanta
Beverly M. DuBose, Citizen Member, Atlanta
William W. Griffin, Citizen Member, Atlanta
Mary Gregory Jewett, Historic Preservation, Decatur
Dr. Lewis H. Larson, Jr., Archeology, Carrollton
Edward W. Neal, Architecture, Columbus

Historic Sites Survey
Historic Preservation Section
Office of Planning and Research
Department of Natural Resources
270 Washington Street, S. W.
Room 703 C-10
Atlanta, Georgia 30334

Phone (404) 656-2840

T E N N E S S E E

GEORGIA

OUTLINE MAP
SHOWING
COUNTIES

SCALE OF MILES
0 10 20 30 40



A
L
A
B
A
M
A

S
O
U
T
H

C
A
R
O
L
I
N
A

F
L
O
R
I
D
A

O
C
E
A
N

A
T
L
A
N
T
I
C

CHAPTER ONE

GEORGIA HISTORIC PRESERVATION CHRONOLOGY

Listed below are some of the important dates in the history of the preservation movement in Georgia.

- 1895 Chickamauga and Chattanooga National Battlefield Park dedicated.
- 1901 Meadow Garden officially dedicated by Daughters of the American Revolution, Augusta.
- 1913 Joel Chandler Harris Memorial Association acquires "Wren's Nest", Atlanta.
- 1924 Fort Pulaski National Monument established, Savannah.
- 1928 Andrew Low House becomes headquarters of Georgia Society of Colonial Dames, Savannah.
- 1929 Georgia Department of Archives and History moves to Rhodes Memorial Hall, Atlanta.
- 1932 Liberty Hall deeded to the State, Crawfordville.
- 1935 Historic Sites Act passed by Congress.
- 1936 Ocmulgee National Monument established, Macon.
Garden Club of Georgia lays plans to restore University of Georgia properties, Athens.
- 1937 Creation of Department of Natural Resources, Division of State Parks, Historic Sites and Monuments.
- 1938 Kolomoki Indian Mounds presented to the State, Blakely.
- 1945 Fort Frederica National Monument established, Saint Simons Island.
- 1947 State purchases Jekyll Island thus saving cottages.
Franklin D. Roosevelt Commission organized to administer public showing of "Little White House."
- 1950 Restoration begun on Bellevue by LaGrange Women's Club.
- 1951 Georgia Historical Commission (GHC) created in the Department of Secretary of State.
- 1952 Etowah Mounds acquired by GHC, Cartersville.
Vann House acquired by GHC, Spring Place.
- 1953 Restoration of Owens-Thomas House begun, Savannah.
- 1955 Crawford W. Long Medical Museum, Jefferson, and Traveler's Rest, Toccoa, acquired by GHC.
Historic Savannah Foundation formed and saves Isaiah Davenport House.
Juliette Gordon Low House purchased, Savannah.
- 1956 New Echota, Calhoun; Eagle Tavern, Watkinsville; and Mackay House, Augusta, acquired by GHC.
- 1957 Midway Museum built by GHC.
- 1958 Thornton House acquired by High Museum of Art, Atlanta.
Washington-Wilkes Historical Museum and Fort McAllister, Richmond Hill, acquired by GHC.

- 1961 Fort King George, Darien, acquired by GHC.
- 1962 Confederate Naval Museum, Columbus, acquired by GHC.
Restoration of Plantation Complex begun at Stone Mt.
- 1964 Georgia Preservation Conference, Columbus, sponsored by West Ga. Chapter AIA and National Trust.
Springer Opera House bought for restoration, Columbus.
Restoration begun on Old Rock House, near Thomson.
- 1965 Fort Jackson acquired by GHC, Savannah.
DuBignon House, Jekyll Island, research project begun by Georgia Society of Colonial Dames.
Old White County Courthouse leased by White County Historical Society, Cleveland.
Callaway Restoration Project begun by City of Washington.
Dell-Goodall House acquired by Screven County Historical Society, Sylvania.
Old Governor's Mansion, Milledgeville, restoration begun.
- 1966 Historic Preservation Act passed by Congress.
Savannah Historic District designated a National Historic Landmark.
William Scarborough House purchased for restoration, Savannah.
Historic Columbus Foundation organized.
Dahlonge Courthouse Gold Museum acquired by GHC.
- 1967 Athens-Clarke Heritage Foundation organized, takes Brumby House as restoration project.
Atlanta Historical Society purchases "Swan House."
Restoration begun on Walker-Peters-Langdon House, Columbus.
- 1968 Fort Morris acquired by GHC, near Midway.
Restoration begun at Westville and Bedingfield Inn.
Restoration begun on Colonial Cemetery, Savannah, by Trustees Garden Club.
- 1969 First Annual Historic Preservation Conference, Athens.
Grand Opera House restoration begun, Macon.
Tullie Smith House donated to Atlanta Historical Society.
Restoration begun on Sanford House, Milledgeville.
Restoration begun on Rankin House, Columbus.
Waynesboro Historical Museum acquired by GHC.
Columbus Historic District placed on National Register.
- 1970 Second Annual Historic Preservation Conference, Augusta.
Chieftains acquired by Rome Junior Service League.
- 1971 Third Annual Historic Preservation Conference, Thomasville.
Lapham-Patterson House acquired by GHC, Thomasville.
- 1972 Fourth Annual Historic Preservation Conference, Columbus.
Milledgeville Historic District placed on the National Register.
Creation of the Georgia Heritage Trust.
Completion of the First State Preservation Plan, in compliance with the National Register Program.
- 1973 Georgia Historical Commission became part of the Department of Natural Resources.
Fifth Annual Preservation Conference, Macon.

Jarrell Plantation, Wormsloe and Robert Toombs House acquired by DNR.
Georgia Trust for Historic Preservation organized.

1974

Sixth Annual Preservation Conference at Rock Eagle near Eatonton.

Mary Gregory Jewett retires from State Preservation work - Heads up the
Georgia Trust for Historic Preservation as president.

Over 250 Georgia Sites on the National Register.

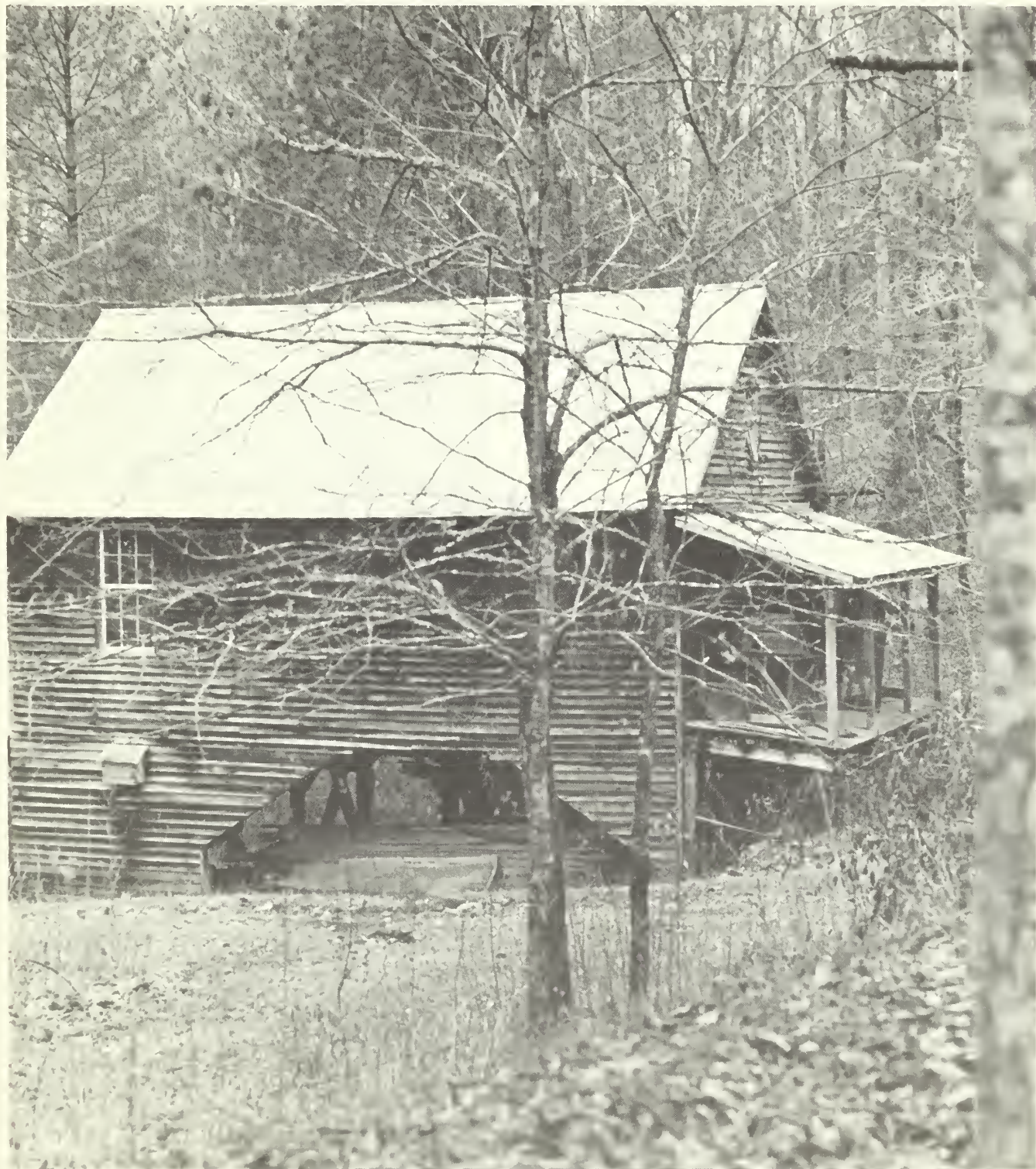

JARRELL PLANTATION — MILL BLDG.

CHAPTER TWO

ORGANIZATIONS AND INDIVIDUALS

Since the first edition of this Handbook in 1971, more and more organizations and individuals have made valuable contributions to historic preservation in Georgia. It is impossible to list every one, but we feel that the listing below is a valuable source for help and information on the federal, state and local levels.

In addition to this list, the Historic Preservation Section maintains an up-to-date file of all organizations and individuals in the state who are involved in preservation and historical activities. This file is a county-by-county listing and the Historic Preservation Section can put you in touch with someone in your area who is involved in preservation work.

We encourage you to contact the Historic Preservation Section if you are interested in forming a preservation or historical group or would like to become involved. We would like to include your name in this file.

FEDERAL

Robert M. Baker
Regional Director
Bureau of Outdoor Recreation
810 New Walton Building
Atlanta, Georgia 30303

Robert R. Garvey, Jr.
Executive Secretary
Advisory Council on Historic
Preservation
1522 K Street, N.W.
Washington, D.C. 20005

E. L. Johnson
Regional Commissioner
National Archives and
Records Service
General Services Administration
1776 Peachtree Street, N.W.
Atlanta, Georgia 30309

Robert H. McNulty
Assistant Director
Architecture and Environmental
Arts Program
National Endowment for the Arts
806 15th Street
Washington, D. C. 20506

William J. Murtagh, Keeper
National Register of Historic Places
National Park Service
Department of Interior
Washington, D.C. 20240

John Poppeliers, Chief
Historic American Buildings Survey
National Park Service
Department of Interior
Washington, D.C. 20240

STATE

Mrs. Pat Bryant
Surveyor General Department
330 Capitol Avenue, S.E.
Atlanta, Georgia 30334

Roy L. Burson, Director
Tourist Division, Department of
Community Development
270 Washington Street, S. W.
Atlanta, Georgia 30334

William W. Griffin, Chairman
Georgia Review Board for
National Register Nominations
1400 Trust Company of Georgia Bldg.
Atlanta, Georgia 30303

Dr. Lewis H. Larson, Jr.
State Archaeologist
103 Martha Munro Hall
West Georgia College
Carrollton, Georgia 30117

Floyd Hardy
Environmental Analysis Bureau
Department of Transportation
Office of Planning
Division of Planning and Program
No. 2 Capitol Square
Atlanta, Georgia 30334

Donn L. Odom
State Librarian
Georgia State Library
301 Judicial Building
Atlanta, Georgia 30334

Miss Carroll Hart, Director
Department of Archives and History
330 Capitol Avenue, S.E.
Atlanta, Georgia 30334

Charles M. Parrish
Director
Office of Planning and Research
Department of Natural Resources
270 Washington Street, S.W.

A.K. Johnson, Jr.
Executive Director
Georgia Commission for the
National Bicentennial Celebration
Suite 520, South Wing
1776 Peachtree Street, N.W.
Atlanta, Georgia 30309

Britt Pendergrast
Georgia Heritage Trust
Department of Natural Resources
270 Washington St., S.W.
Atlanta, Georgia, 30334

Jackson O'Neal Lamb
Chief
Historic Preservation Section
Department of Natural Resources
270 Washington Street, S.W.
Atlanta, Georgia 30334

Hank Struble
Director
Division of Parks and Historic
Sites
Department of Natural Resources
270 Washington St., S.W.
Atlanta, Georgia 30334

Alston Waylor
Chief, Historic Sites Operation
Division of Parks and Historic Sites
Department of Natural Resources
270 Washington Street, S.W.
Atlanta, Georgia 30334

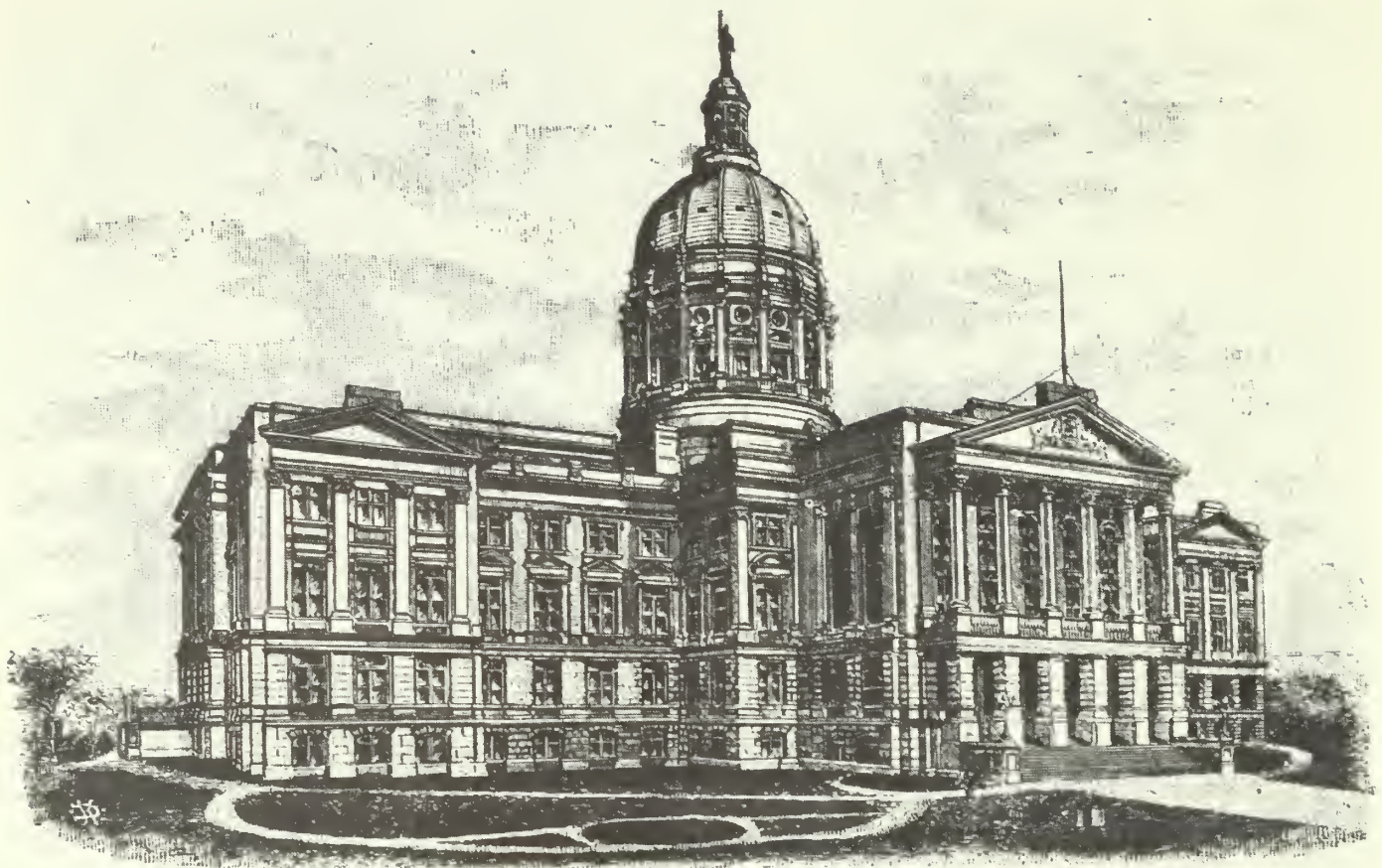

STATE CAPITOL AT ATLANTA.
1890

STATE CAPITOL - 1890

PRIVATE

Lee Adler, Georgia Advisor
National Trust for Historic Preservation
One Bull Street
Savannah, Georgia 31401

William T. Alderson, Director
American Association of State and
Local History
1315 Eighth Avenue
Nashville, Tennessee 37203

Ms. Rosann S. Berry, Executive Secretary
Society of Architectural Historians
1700 Walnut Street
Philadelphia, Pennsylvania 19103

James Biddle, President
National Trust for Historic Preservation
740-748 Jackson Place, N. W.
Washington, D.C. 20006

Mrs. Janice P. Biggers
Executive Vice-President
Historic Columbus Foundation
Post Office Box 5312
Columbus, Georgia 31902

Clifford M. Clarke
Executive Director
Bicentennial Council of the
Thirteen Original States
Suite 2004
400 Colony Square
Atlanta, Georgia 30361

Franklin M. Garrett, Historian
Atlanta Historical Society
Post Office Box 12423
Atlanta, Georgia 30305

Joseph B. Mahan, Executive Director
Westville Historic Handicrafts, Inc.
Post Office Box 848
Lumpkin, Georgia 31815

William W. Griffin, Chairman
Georgia Trust for Historic Preservation
1400 Trust Company of Georgia Building
Atlanta, Georgia 30303

William R. Mitchell, Jr.
Executive Director
Historic Augusta, Inc.
506 Telfair Street
Augusta, Georgia 30901

Mrs. Lilla M. Hawes, Director
Georgia Historical Society
501 Whitaker Street
Savannah, Georgia 31401

Paul Muldawer
State Preservation Coordinator
for Georgia
American Institute of Architects
33 Ponce de Leon Avenue
Atlanta, Georgia 30308

Mrs. Mary Gregory Jewett
President
Georgia Trust for Historic
Preservation
3308 F Covington Drive
Decatur, Georgia 30032

Cecil R. Phillips
President
The Georgia Conservancy
Suite 402
3376 Peachtree Road, N. E.
Atlanta, Georgia 30326

Norman C. Larson, Executive Director
Thomasville Landmarks, Inc.
Post Office Box 1285
Thomasville, Georgia 31792

Mrs. Gene Talmadge, Executive Director
Historic Jonesboro, Inc.
330 Arrowhead Boulevard
Jonesboro, Georgia 30236

Ms. Beth Lattimore
Assistant Director
Historic Savannah Foundation
119 Habersham Street
Savannah, Georgia 31402

CHAPTER THREE

THE NATIONAL REGISTER OF HISTORIC PLACES – What is it?

The National Register of Historic Places was created by the Historic Preservation Act of 1966 (Public Law 89-665). The law authorized the Secretary of the Interior to maintain “a national register of districts, sites, buildings, structures, and objects significant in American history, architecture, archaeology and culture.” Properties which meet the criteria and are entered on the Register are recorded, recognized and protected as cultural elements worthy of preservation. National Register listing provides for protection from impairment by federally funded or federally licensed projects. No restrictions as to use and disposition of registered properties are made on property owners. The restrictions are placed only on federal agencies whose activities might “adversely affect” the registered property. In addition, the National Register Program provides for matching grants for acquisition and/or restoration of registered properties and for historical and archeological surveys. A State Historic Preservation Plan and Annual Preservation Program are prepared by the Historic Sites Survey Staff, providing the basis for the implementation of the entire National Register Program in Georgia.

THE NATIONAL REGISTER OF HISTORIC PLACES is published biennially with pertinent information about individual properties. In 1969, the first edition contained thirteen sites from Georgia. Today more than 250 Georgia properties have been entered on the Register. This was made possible beginning in July 1969 when state funds to match a federal grant were given to the Georgia Historical Commission to begin implementing the Historic Preservation Act. In each state, the National Register program is administered by a State Historic Preservation Officer who supervises preservation planning and the statewide historic survey. Proposals for National Register nominations are recommended to a professional Review Board by the State Historic Preservation Officer. If a property meets National Register criteria, the Board recommends it for nomination to the National Register. In Georgia, this work is carried out by the Historic Preservation Section. Chief of this section directs the program utilizing a professional staff, with expertise in architecture, archeology, history, photography and planning. An eight-man professional council serves as the State Review Board.

Examples of National Register nomination forms for the Vann House and the Milledgeville Historic District follow to assist you in evaluating properties for consideration. Also included here is a criteria for evaluation and a listing of those properties, to date, which are included on the National Register.

The Historic Preservation Section calls upon volunteers to assist in the statewide survey leading to additions to the National Register. Nomination forms are available from the Historic Preservation Section.

Structural and Site Survey forms, used to prepare National Register forms, are also available from the Historic Preservation Section. A sample survey form is included in Chapter Four.

**NATIONAL REGISTER OF HISTORIC PLACES
INVENTORY - NOMINATION FORM**

(Type all entries - complete applicable sections)

STATE: Georgia	
COUNTY: Murray	
FOR NPS USE ONLY	
ENTRY NUMBER	DATE

1. NAME

COMMON:
Vann House

AND/OR HISTORIC:

2. LOCATION

STREET AND NUMBER:
Intersection U.S. 76 and Ga. 225

CITY OR TOWN:
Spring Place

STATE Georgia	CODE 13	COUNTY: Murray	CODE 213
------------------	------------	-------------------	-------------

3. CLASSIFICATION

CATEGORY (Check One)	OWNERSHIP	STATUS	ACCESSIBLE TO THE PUBLIC
<input type="checkbox"/> District <input checked="" type="checkbox"/> Building <input type="checkbox"/> Site <input type="checkbox"/> Structure <input type="checkbox"/> Object	<input checked="" type="checkbox"/> Public <input type="checkbox"/> Private <input type="checkbox"/> Both	Public Acquisition: <input type="checkbox"/> In Process <input type="checkbox"/> Being Considered	<input type="checkbox"/> Occupied <input checked="" type="checkbox"/> Unoccupied <input type="checkbox"/> Preservation work in progress
PRESENT USE (Check One or More as Appropriate)			
<input type="checkbox"/> Agricultural <input type="checkbox"/> Commercial <input type="checkbox"/> Educational <input type="checkbox"/> Entertainment	<input type="checkbox"/> Government <input type="checkbox"/> Industrial <input type="checkbox"/> Military <input checked="" type="checkbox"/> Museum	<input type="checkbox"/> Park <input type="checkbox"/> Private Residence <input type="checkbox"/> Religious <input type="checkbox"/> Scientific	<input type="checkbox"/> Transportation <input type="checkbox"/> Other (Specify) _____ _____ _____
Yes: <input checked="" type="checkbox"/> Restricted <input type="checkbox"/> Unrestricted <input type="checkbox"/> No			

4. OWNER OF PROPERTY

OWNER'S NAME:
State of Georgia (Georgia Historical Commission)

STREET AND NUMBER:
116 Mitchell Street, S.W.

CITY OR TOWN:
Atlanta

STATE:
Georgia

CODE:
13

STATE:
Georgia

5. LOCATION OF LEGAL DESCRIPTION

COURTHOUSE, REGISTRY OF DEEDS, ETC.:
Murray County Courthouse, Deed Book 26, p. 260

STREET AND NUMBER:

CITY OR TOWN:
Chatsworth

STATE:
Georgia

CODE:
13

COUNTY:
Murray

6. REPRESENTATION IN EXISTING SURVEYS

TITLE OF SURVEY:
Historic American Building Survey

DATE OF SURVEY: 1934, 1936 Federal State County Local

DEPOSITORY FOR SURVEY RECORDS:
Library of Congress

STREET AND NUMBER:

CITY OR TOWN:
Washington

STATE:
D.C.

CODE:
08

ENTRY NUMBER

DATE

FOR NPS USE ONLY

7. DESCRIPTION

CONDITION	(Check One)					
	<input checked="" type="checkbox"/> Excellent	<input type="checkbox"/> Good	<input type="checkbox"/> Fair	<input type="checkbox"/> Deteriorated	<input type="checkbox"/> Ruins	<input type="checkbox"/> Unexposed
	(Check One)			(Check One)		
	<input type="checkbox"/> Altered	<input checked="" type="checkbox"/> Unaltered	<input type="checkbox"/> Moved	<input checked="" type="checkbox"/> Original Site		

DESCRIBE THE PRESENT AND ORIGINAL (if known) PHYSICAL APPEARANCE

Vann House, a furnished historic house museum, administered by the Georgia Historical Commission, was dedicated and opened to the public in July 1958. When the Commission acquired the property in 1952, the house was rapidly deteriorating but had not been significantly changed architecturally from the way it appeared about 1805. The restoration architect was Dr. Henry Chandlee Forman of Easton, Maryland.

The plantation residence first of James Vann (1768-1809), a rich Cherokee half-breed, and then of his son, Joseph, the house was begun about 1803. James Vann moved into the house March 24, 1805. Involved in its building were Moravian missionary craftsmen from nearby Spring Place, Georgia, and other carpenters, one of whom was from North Carolina. Its architectural style is best described as Federal, but aspects of the continuing tradition of the American Georgian style are apparent.

Exterior: Single outside brick chimneys rise at each gable end of a low-pitched gable roof, framing two-story high solid brick walls of brick made on the place. Front and rear façades each have a classic cornice with modillions and a row of dentils, two-story whitewashed plaster pilasters, and two fanlighted doorways one above the other framed by large painted wood paneling and opening off wide hallways onto covered porches. The original porches, front and back, had disappeared. Dr. Forman conjectured that they were Federal style temple-front porticos rising two stories with a pediment. The entrance facade, which faced the old Federal Road, is perfectly symmetrical. The rear facade has irregularly spaced windows and a dining room doorway leading to the outside. All windows are nine-over-nine, capped by a whitewashed lintel.

Interior: On each of the two main floors are two rooms, 30 by 20 feet, with a wide hallway between. (The attic story contains two long coffin shaped rooms.) Inside, to the left of the main entrance, is an elaborately carved and wainscoted stairway, an early example of cantilevered construction. This intricate carpentry and other fine woodwork throughout the house derives its beauty from expert joinery, fine carving and workmanship, good proportion, and striking color combinations. Outside and inside, a special feature is a small carved rose medallion representing the variety of rose known as Cherokee.

An imposing chimney piece reaches the high ceiling in the drawing room to the right of the main first floor entrance. An especially fine example of wood craftsmanship and design in the Federal style, there are also strong late-Georgian overtones in the arched and columned overmantel surmounted by a formal entablature. The original paint colors - blue, red, green, yellow - were uncovered during restoration and have been matched.

SEE INSTRUCTIONS

8. SIGNIFICANCE

PERIOD (Check One or More as Appropriate)

- Pre-Columbian | 16th Century | 18th Century | 20th Century
 15th Century | 17th Century | 19th Century

SPECIFIC DATE(S) (If Applicable and Known) c. 1803 - c. 1805

AREAS OF SIGNIFICANCE (Check One or More as Appropriate)

- | | | | |
|--|--|---|---|
| <input type="checkbox"/> Aboriginal | <input checked="" type="checkbox"/> Education | <input checked="" type="checkbox"/> Political | <input type="checkbox"/> Urban Planning |
| <input type="checkbox"/> Prehistoric | <input type="checkbox"/> Engineering | <input checked="" type="checkbox"/> Religion/Philosophy | <input checked="" type="checkbox"/> Other (Specify) |
| <input checked="" type="checkbox"/> Historic | <input type="checkbox"/> Industry | | <u>History</u> |
| <input type="checkbox"/> Agriculture | <input type="checkbox"/> Invention | <input type="checkbox"/> Science | _____ |
| <input checked="" type="checkbox"/> Architecture | <input checked="" type="checkbox"/> Landscape Architecture | <input type="checkbox"/> Sculpture | _____ |
| <input checked="" type="checkbox"/> Art | | <input type="checkbox"/> Social/Humanitarian | _____ |
| <input type="checkbox"/> Commerce | <input type="checkbox"/> Literature | <input type="checkbox"/> Theater | _____ |
| <input type="checkbox"/> Communications | <input checked="" type="checkbox"/> Military | <input type="checkbox"/> Transportation | _____ |
| <input type="checkbox"/> Conservation | <input type="checkbox"/> Music | | _____ |

STATEMENT OF SIGNIFICANCE

March 24, 1805, the Moravian missionaries James Vann helped establish near his plantation at Spring Place wrote in their diary, "Vann moved into his newly built house today." Located on the Federal Road, Vann House commanded an elevation amidst a complex of dependencies. The showplace of the Cherokee Nation, it is significant as a mansion house of architectural and historical distinction deep in Indian country.

James Vann, (1768-1809) whose mother was Cherokee and his father a Scot, made his major contribution to his mother's people, as well as to Georgia history, by sponsoring the Moravian mission and making it part of the complex of buildings in and around Spring Place. A hard-driving, hard-drinking businessman, Vann encouraged the missionary effort so that young Cherokees might begin their education in the mission school. Future Cherokee leaders Elias Boudinot and John Ridge were educated by the Moravians, as was James' own son, Joseph. Two entries made in the Spring Place Moravian Diaries are especially important. The first dated January 17, 1804, reads, "Brothers Byhan and Martin Schneider again went to help Vann in building his new home." And the second, dated August 13, 1804, "Today the chiefs assembled at Vann's new house close by our place. They were lodged at Vann's."

Joseph Vann inherited Vann House and much of his father's other property in 1814 after much litigation. An even better businessman than his father, he soon became known as "Rich Joe Vann" by the Indians and whites alike. In May 1819, Vann received President Monroe, Secretary of War John C. Calhoun and other dignitaries as they made their way along the Federal Road. The Mission diary records it in this way: "Very late in the evening...the President of the United States and his party... arrived at Joseph Vann's."

In 1834 William N. Bishop leading a troop of Georgia guardsmen turned Joseph Vann and his family out of Vann House during the Cherokee Removal. Later the Federal Government paid Vann \$19,605.00 for his property in Georgia; the inventory of that property is significant: "one fine brick house, 800 acres of cultivated land, 42 cabins, six barns, five smoke-houses, a grist mill, blacksmith shop, eight corn cribs, a shop and foundry, a trading post, a peach kiln, a still, 1,133 peach trees, 147 apple trees, [etc]."

9. MAJOR BIBLIOGRAPHICAL REFERENCES

Minutes of the Conference of Missionaries at Spring Place in the Country of the Cherokee Indians, March 24, 1802 - October 1819.
Diary of the Brethern and Sisters...at Spring Place in the land of the Cherokees, Beginning June 1, 1803 and running to May 1819.
 Files of the Georgia Historical Commission (Old photographs and other documentation).
 Mitchell, William R., Personal Inspection, August 1969.
 Nichols, Frederick Doveton, The Early Architecture of Georgia. (Chapel Hill: University of North Carolina Press, 1957).

10. GEOGRAPHICAL DATA

LATITUDE AND LONGITUDE COORDINATES DEFINING A RECTANGLE LOCATING THE PROPERTY			O R	LATITUDE AND LONGITUDE COORDINATES DEFINING THE CENTER POINT OF A PROPERTY OF LESS THAN TEN ACRES		
CORNER	LATITUDE	LONGITUDE		LATITUDE	LONGITUDE	
	Degrees Minutes Seconds	Degrees Minutes Seconds		Degrees Minutes Seconds	Degrees Minutes Seconds	
NW	° ' "	° ' "		34 ° 45 ' 50 "	84 ° 50 ' 35 "	
NE	° ' "	° ' "				
SE	° ' "	° ' "				
SW	° ' "	° ' "				

APPROXIMATE ACREAGE OF NOMINATED PROPERTY: less than one acre

LIST ALL STATES AND COUNTIES FOR PROPERTIES OVERLAPPING STATE OR COUNTY BOUNDARIES

STATE:	CODE	COUNTY	CODE
STATE:	CODE	COUNTY:	CODE
STATE:	CODE	COUNTY:	CODE
STATE:	CODE	COUNTY:	CODE

11. FORM PREPARED BY

NAME AND TITLE:
 William R. Mitchell, Jr., Director, Georgia Historic Sites Survey

ORGANIZATION: Georgia Historical Commission DATE: Sept. 9, 1969

STREET AND NUMBER:
 116 Mitchell Street, S.W.

CITY OR TOWN: Atlanta STATE: Georgia CODE: 13

12. STATE LIAISON OFFICER CERTIFICATION NATIONAL REGISTER VERIFICATION

As the designated State Liaison Officer for the National Historic Preservation Act of 1966 (Public Law 89-665), I hereby nominate this property for inclusion in the National Register and certify that it has been evaluated according to the criteria and procedures set forth by the National Park Service. The recommended level of significance of this nomination is:

National State Local

Name Mary Gregory Jewett

Title State Liaison Officer

Date September 11, 1969

I hereby certify that this property is included in the National Register.

Chief, Office of Archeology and Historic Preservation

Date _____

ATTEST:

Keeper of The National Register

Date _____

SEE INSTRUCTIONS

**NATIONAL REGISTER OF HISTORIC PLACES
INVENTORY - NOMINATION FORM**

(Type all entries complete applicable sections)

STATE: Georgia
COUNTY: Baldwin
FOR NPS USE ONLY
ENTRY DATE

1. NAME

COMMON: Milledgeville Historic District
AND/OR HISTORIC:

2. LOCATION

STREET AND NUMBER: Bounded by Irwin, Thomas, Warren Streets, and Fishing Creek			
CITY OR TOWN: Milledgeville		CONGRESSIONAL DISTRICT: 8th Williamson S. Stuckey	
STATE Georgia	CODE 13	COUNTY: Baldwin	CODE 009

3. CLASSIFICATION

CATEGORY (Check One)	OWNERSHIP	STATUS	ACCESSIBLE TO THE PUBLIC
<input checked="" type="checkbox"/> District <input type="checkbox"/> Building <input type="checkbox"/> Site <input type="checkbox"/> Structure <input type="checkbox"/> Object <input checked="" type="checkbox"/> Both	<input type="checkbox"/> Public <input type="checkbox"/> Private <input checked="" type="checkbox"/> Both	Public Acquisition: <input type="checkbox"/> In Process <input type="checkbox"/> Being Considered	<input checked="" type="checkbox"/> Occupied <input type="checkbox"/> Unoccupied <input checked="" type="checkbox"/> Preservation work in progress
PRESENT USE (Check One or More as Appropriate)			
<input type="checkbox"/> Agricultural <input checked="" type="checkbox"/> Commercial <input checked="" type="checkbox"/> Educational <input type="checkbox"/> Entertainment	<input type="checkbox"/> Government <input type="checkbox"/> Industrial <input type="checkbox"/> Military <input type="checkbox"/> Museum	<input type="checkbox"/> Park <input checked="" type="checkbox"/> Private Residence <input type="checkbox"/> Religious <input type="checkbox"/> Scientific	<input type="checkbox"/> Transportation <input type="checkbox"/> Other (Specify) _____ _____ _____
<input type="checkbox"/> Comments _____ _____ _____			

4. OWNER OF PROPERTY

OWNER'S NAME: Multiple Owners	STATE: Georgia
STREET AND NUMBER:	
CITY OR TOWN: Milledgeville	
STATE: Georgia	CODE: 13

5. LOCATION OF LEGAL DESCRIPTION

COURTHOUSE, REGISTRY OF DEEDS, ETC.: Office of Superior Court, Baldwin County Courthouse	STATE: Georgia
STREET AND NUMBER: Hancock Street	
CITY OR TOWN: Milledgeville	
STATE: Georgia	CODE: 13

6. REPRESENTATION IN EXISTING SURVEYS

TITLE OF SURVEY: (a) Some buildings listed in Historic American Buildings Survey (b) Old Capital Historical Society Survey	STATE: (a) D.C. (08) (b) Georgia (13)
DATE OF SURVEY: (a) 1930's (b) 1972 <input checked="" type="checkbox"/> Federal <input type="checkbox"/> State <input type="checkbox"/> County <input checked="" type="checkbox"/> Local	
DEPOSITORY FOR SURVEY RECORDS: (a) Library of Congress (b) Old Capital Historical Society	CODE: 13
STREET AND NUMBER:	
CITY OR TOWN: (a) Washington (b) Milledgeville	DATE

STATE: Georgia
COUNTY: Baldwin
ENTRY NUMBER
DATE

FOR NPS USE ONLY

7. DESCRIPTION

CONDITION	(Check One)					
	<input type="checkbox"/> Excellent	<input checked="" type="checkbox"/> Good	<input type="checkbox"/> Fair	<input type="checkbox"/> Deteriorated	<input type="checkbox"/> Ruins	<input type="checkbox"/> Unexpased
	(Check One)			(Check One)		
	<input checked="" type="checkbox"/> Altered	<input type="checkbox"/> Unaltered	<input type="checkbox"/> Moved	<input checked="" type="checkbox"/> Original Site		

DESCRIBE THE PRESENT AND ORIGINAL (if known) PHYSICAL APPEARANCE

The area comprising the Milledgeville Historic District includes essentially that part of the city laid out in the plan of 1803. Situated within an Indian land cession of 1802, Milledgeville is located on a bluff at the head of navigation of the Oconee River. Milledgeville was officially designated the state capital in 1804 and the city plan reflects that purpose, as seen in the enclosed xerox copy of "A Plan of Milledgeville," drawn in 1808 by Daniel Sturges.

Total acreage of the city was determined by the Legislature at 3240 acres, to be divided into 16 tracts of 202 and 1/2 acres each. The land was further divided into 1-acre lots, a relatively large dimension for town lots. Streets were laid out in a grid pattern, all 100 feet wide with the exception of Washington and Jefferson Streets which were 120 feet wide. Originally three large squares were reserved for particular purposes - one each for a state house, governor's residence and penitentiary. A few years later another square was set aside for public use, or a cemetery. These four squares, providing for major governmental functions, were major features of the city plan. The combination of broad streets and Savannah-style squares gave Milledgeville a decidedly garden city aspect, but one that was still appropriate for its purpose - the state capital.

On State House Square, at the intersection of Washington and Jefferson Streets, a stucco-covered brick building was erected to house the Legislature, offices for the Governor and other state officials. This Gothic Revival style structure was begun in 1807 and completed prior to 1833 with the addition of four wings (Photograph #1). According to White's Statistics of Georgia, 1849, the penitentiary proper was of granite construction and the surrounding walls of brick. Governor's Square was not used as planned for the site of the chief-of-state's residence. Instead, the Governor's Mansion, completed in 1838 and a fine example of Classical Revival architecture, was erected on Clark Street, one block south of Penitentiary Square (Photograph #2). Many of Milledgeville's and Georgia's most illustrious citizens during the years when the city was the state capital are buried in the square reserved for the cemetery. By 1842, construction of private residences, inns, churches, commercial buildings and increasing population, reflecting Milledgeville's importance as state capital and as a trading center, expanded the city limits well beyond those set in 1803.

During the Civil War and the subsequent removal of the capital to Atlanta, Milledgeville's economy suffered but the plan and most buildings did not. Sherman occupied Milledgeville but did not destroy it. The historic fabric of the town was not changed by war, new economic developments or expansion of governmental activities during the post-War years. The squares and major buildings remain today essentially as they were in the mid-19th century. An especially fine non-governmental building of the early era is the Masonic Hall. It still serves its original purpose and is essentially unchanged (Photographs #3-7). The State House, destroyed by fire in 1941, has been carefully reconstructed and now serves as the administration building for Georgia Military College (Photograph #1). (It was added to the National Register, February 1, 1972.) Penitentiary Square has been developed as the campus of Georgia College at Milledgeville. The oldest college building, Atkinson Hall, was added to the Register, February 1, 1972 (Photograph #8). The Governor's Mansion, added to the Register February 1, 1972, is owned by the State Board of Regents and beautifully maintained as the college presi-

S E E I N S T R U C T I O N S

8. SIGNIFICANCE

PERIOD (Check One or More as Appropriate)

- | | | | |
|--|---------------------------------------|--|--|
| <input type="checkbox"/> Pre-Columbian | <input type="checkbox"/> 16th Century | <input type="checkbox"/> 18th Century | <input checked="" type="checkbox"/> 20th Century |
| <input type="checkbox"/> 15th Century | <input type="checkbox"/> 17th Century | <input checked="" type="checkbox"/> 19th Century | |

SPECIFIC DATE(S) (If Applicable and Known) C. 1803

AREAS OF SIGNIFICANCE (Check One or More as Appropriate)

- | | | | |
|--|--|---|---|
| <input type="checkbox"/> Aboriginal | <input checked="" type="checkbox"/> Education | <input checked="" type="checkbox"/> Political | <input checked="" type="checkbox"/> Urban Planning |
| <input type="checkbox"/> Prehistoric | <input type="checkbox"/> Engineering | <input type="checkbox"/> Religion/Philosophy | <input checked="" type="checkbox"/> Other (Specify)
<u>History</u> |
| <input type="checkbox"/> Historic | <input type="checkbox"/> Industry | <input type="checkbox"/> Science | _____ |
| <input type="checkbox"/> Agriculture | <input type="checkbox"/> Invention | <input type="checkbox"/> Sculpture | _____ |
| <input checked="" type="checkbox"/> Architecture | <input checked="" type="checkbox"/> Landscape Architecture | <input type="checkbox"/> Social/Humanitarian | _____ |
| <input type="checkbox"/> Art | <input type="checkbox"/> Literature | <input type="checkbox"/> Theater | _____ |
| <input checked="" type="checkbox"/> Commerce | <input checked="" type="checkbox"/> Military | <input type="checkbox"/> Transportation | _____ |
| <input type="checkbox"/> Communications | <input type="checkbox"/> Music | | _____ |
| <input type="checkbox"/> Conservation | | | _____ |

STATEMENT OF SIGNIFICANCE

The Milledgeville Historic District includes essentially the same area which was planned as the capital of Georgia in 1803 and which was so designated by the State Legislature in 1804. Although Milledgeville no longer serves as state capital and the public buildings have been put to other uses, the original capital city plan survives today. Encroachments on the historic area demand that methods be employed to preserve not only the integrity of the plan itself but also the many outstanding structures of both historical and architectural significance which are located within the District. Inclusion of the Milledgeville Historic District on the National Register of Historic Places will provide means and procedures for the plan's protection as well as national recognition of the district's deserved importance.

The State of Georgia considered town planning so important that the Legislature provided for the founding, planning and early governing of major towns not included in the original colony. Inhibiting land speculation, utilizing public land to its best advantage and considering future growth, health and spaciousness were factors taken into account when contemplating a town site and plan. An 1803 legislative act called for the laying out of land districts within an area west of the Oconee River which had been ceded to the U.S. Government by the Creek Indian Nation in 1802. Five Commissioners were also appointed to select an appropriate site at the head of navigation of the Oconee to be reserved for a city to be called Milledgeville, in honor of then Governor John Milledge. These same commissioners were charged with preparing a plan for the city. In the 1804 legislative session the site and plan for Milledgeville were approved and the city officially designated the state capital.

Immediate steps were taken for designing and constructing a State House, the contract let to Major General Jett Thomas and John Scott in 1805. On October 9, 1807, state records were transferred into the Gothic Revival style State House from Louisville the former capital. In the 61 years that Milledgeville served as the state capital, many significant events occurred which greatly affected the history of Georgia - in 1823, Governor George M. Troup's state's right issue; in 1832, tariff debates; in 1838, the final removal of the Cherokees from Georgia; and on January 13, 1861, the convening of the Secession Convention. War came to Milledgeville in 1864; Sherman's headquarters were established in the Governor's Mansion. Milledgeville remained the state capital until 1868 at which time the seat of government was once again transferred, this time to Atlanta. During the post-War era, preservation was the natural result of an altered, much-slowed down economy. Victorian style architectural modifications occurred (Photograph

SEE INSTRUCTIONS

NATIONAL REGISTER OF HISTORIC PLACES
INVENTORY - NOMINATION FORM

(Continuation Sheet)

STATE	
Georgia	
COUNTY	
Baldwin	
FOR NPS USE ONLY	
ENTRY NUMBER	DATE

(Number all entries)

7. Description

dent's residence (Photograph #2). Government Square remains a wilderness open space. Cemetery Square continues to serve its original function.

Street after original street continues to hold its long-time character planned and established during the Federal Period. Every major architectural type and style is represented within this tree-shaded district (Photographs #9-13). Outstanding little-altered Federal period landmarks such as the Williams-Orme-Crawford House (Photograph #14), the Cedars (Photograph #15), and the Ferguson House (Photograph #16) survive essentially unchanged. Other simpler Federal period houses also survive many of them pleasantly altered with Victorian trim (Photograph #17). The Victorian era itself is well-represented by a number of structures such as the Old Opera House shown in Photograph #18 and the house shown in Photograph #19.

However, the picture of a preserved town may be painted here too sympathetically for threats to its integrity are constant and only legal protection-national, state, and local - can continue to preserve this city which was planned during the Federal Period and served as Georgia's capital city until 1868.

When comparing the 1808 city plan and the area designated as the Historic District, only a small discrepancy is apparent. The north, south and west boundaries coincide. On the east side of the District, the boundary is reduced by two blocks, since this section of the city shows little development.

[Photographs are numbered on the back of each photograph and in the top left-hand corner of the Property Photograph Form,]

NATIONAL REGISTER OF HISTORIC PLACES
INVENTORY - NOMINATION FORM

(Continuation Sheet)

STATE Georgia	
COUNTY Baldwin	
FOR NPS USE ONLY	
ENTRY NUMBER	DATE

(Number all entries)

8. Significance

#17) but the planned city suffered few major changes until late 19th century economic and social changes disturbed the somewhat sleepy former capital city. In 1889 Milledgeville became a "college town" when the State Legislature established the Georgia Normal and Industrial College and deeded Penitentiary Square to the college. In 1896 this square became the college campus when Atkinson Hall was completed and opened as a dormitory, dining hall and infirmary. About 1920 large brick buildings were erected on either side of the Hall and subsequent to that other changes have taken place within the old original square (Photograph #8).

As a result of continued growth, such as that discussed above, the Old Capital Historical Society initiated a survey of historical and architectural landmarks as a first step toward preserving Milledgeville's historic Federal and Classical Revival character. The essentially preserved town plan and an abundance of fine pre-Civil War period buildings were the Society's major concern. Extensive commons, wide streets and four Savannah-style squares survived as originally designed in the city plan. State House Square had become part of the Georgia Military College; the reconstructed State House had become the administration building (Photograph #1). Penitentiary Square now contained Georgia College, previously called Georgia Normal and Industrial College (Photograph #8); the Governor's Mansion housed the college president (Photograph #2). The square set aside originally for public use still served as the burial ground it had become since a few years after the city's founding. Government Square, originally planned for the site of a governor's residence, remained a wilderness to the present. In addition to major features are innumerable other surviving aspects worth preserving and these have been included in the survey now being completed by the Old Capital Historical Society, an organization with a broad base of support throughout the community.

[Photographs are numbered on the back of each photograph and in the top left-hand corner of the Property Photograph Form.]

9. MAJOR BIBLIOGRAPHICAL REFERENCES

Hines, Nelle Womack, A Treasure Album of Milledgeville and Baldwin County, Georgia. (n.p.: J.W. Burke Company, 1949).
 Jennings, J.L. Sibley, Jr., Milledgeville and Milledgeville Vicinity. (unpublished manuscript, 1968), on file at Georgia Historical Commission.
 Linley, John, Oconee Architecture. (unpublished manuscript, 1972), GHC files.
 Nichols, Frederick Doveton, The Early Architecture of Georgia. (Chapel Hill: University of North Carolina Press, 1957).
 Sears, Joanna, "Planning in Georgia - Yesterday," Urban Georgia. Vol. XXI No. 9 (September 1971).
 White, George, Statistics of the State of Georgia. (Savannah: W. Thorne Williams, 1849).

10. GEOGRAPHICAL DATA

LATITUDE AND LONGITUDE COORDINATES DEFINING A RECTANGLE LOCATING THE PROPERTY			O R	LATITUDE AND LONGITUDE COORDINATES DEFINING THE CENTER POINT OF A PROPERTY OF LESS THAN TEN ACRES		
CORNER	LATITUDE	LONGITUDE		LATITUDE	LONGITUDE	
	Degrees Minutes Seconds	Degrees Minutes Seconds		Degrees Minutes Seconds	Degrees Minutes Seconds	
NW	33 ° 05 ' 10 "	83 ° 14 ' 20 "		0 . .	0 . .	
NE	33 ° 05 ' 10 "	83 ° 13 ' 06 "				
SE	33 ° 04 ' 15 "	83 ° 13 ' 06 "				
SW	33 ° 04 ' 15 "	83 ° 14 ' 20 "				

APPROXIMATE ACREAGE OF NOMINATED PROPERTY: **3240 acres**

LIST ALL STATES AND COUNTIES FOR PROPERTIES OVERLAPPING STATE OR COUNTY BOUNDARIES

STATE:	CODE	COUNTY	CODE
STATE:	CODE	COUNTY:	CODE
STATE:	CODE	COUNTY:	CODE
STATE:	CODE	COUNTY:	CODE

11. FORM PREPARED BY

NAME AND TITLE:
 William R. Mitchell, Jr., Director, Georgia Historic Sites Survey
 Carole A. Summers, Assistant

ORGANIZATION: Georgia Historical Commission DATE: May 25, 1972

STREET AND NUMBER:
 116 Mitchell Street, S.W.

CITY OR TOWN: Atlanta STATE: Georgia CODE: 13

12. STATE LIAISON OFFICER CERTIFICATION

As the designated State Liaison Officer for the National Historic Preservation Act of 1966 (Public Law 89-665), I hereby nominate this property for inclusion in the National Register and certify that it has been evaluated according to the criteria and procedures set forth by the National Park Service. The recommended level of significance of this nomination is:

National State Local

Name Mary Gregory Jewitt

Title State Liaison Officer

Date May 25, 1972

NATIONAL REGISTER VERIFICATION

I hereby certify that this property is included in the National Register

 Director, Office of Archeology and Historic Preservation

Date _____

ATTEST:

 Keeper of The National Register

Date _____



VANN HOUSE 1804 - SPRING PLACE

CRITERIA FOR EVALUATION

The following criteria are designed to guide the States and the Secretary of the Interior in evaluating potential entries (other than areas of the National Park System and National Historic Landmarks) to the National Register:

The quality of significance in American history, architecture, archeology, and culture is present in districts, sites, buildings, structures, and objects that possess integrity of location, design, setting, materials, workmanship, feeling, and association, and:

(A) that are associated with events that have made a significant contribution to the broad patterns of our history; or

(B) that are associated with the lives of persons significant in our past; or

(C) that embody the distinctive characteristics of a type, period, or method of construction, or that represent the work of a master, or that possess high artistic values, or that represent a significant and distinguishable entity whose components may lack individual distinction; or

(D) that have yielded, or may be likely to yield, information important in prehistory or history.

Ordinarily cemeteries, birthplaces, or graves of historical figures, properties owned by religious institutions or used for religious purposes, structures that have been moved from their original locations, reconstructed historic buildings, properties primarily commemorative in nature, and properties that have achieved significance within the past 50 years shall not be considered eligible for the National Register. However, such properties will qualify if they are integral parts of districts that do meet the criteria or if they fall within the following categories:

(A) a religious property deriving primary significance from architectural or artistic distinction or historical importance; or

(B) a building or structure removed from its original location but which is significant primarily for architectural value, or which is the surviving structure most importantly associated with a historic person or event; or

(C) a birthplace or grave of a historical figure of outstanding importance if there is no appropriate site or building directly associated with his productive life; or

(D) a cemetery which derives its primary significance from graves of persons of transcendent importance, from age, from distinctive design features, or from association with historic events; or

(E) a reconstructed building when accurately executed in a suitable environment and presented in a dignified manner as part of a restoration master plan, and when no other building or structure with the same association has survived; or

(F) a property primarily commemorative in intent if design, age, tradition, or symbolic value has invested it with its own historical significance; or

(G) a property achieving significance within the past 50 years if it is of exceptional importance.

NATIONAL REGISTER PROPERTIES

The following list of sites in Georgia represent the most current listing as of this publication date. Sites are nominated on the average of over 100 a year to the Register. A current, up-dated listing is always available in the office of the Historic Preservation Section.

Baldwin County:	Atkinson Hall Milledgeville Historic District Old Governor's Mansion Old State Capitol
Barrow County:	Fort Yargo
Bartow County:	Etowah Mounds Archaeological Area Roselawn (Sam Jones House) Valley View
Bibb County:	Anderson Home (Judge Clifford) R.J. Anderson House Ambrose Baber House T.C. Burke House Cannon Ball House Carmichael House Central City Park Band Stand Christ Episcopal Church Jerry Cowles Cottage Dasher-Stevens House Davis-Guttenberger-Rankin Home Domingos Home Emerson-Holmes Building Findlay House First Presbyterian Church Goodall House Grand Opera House Hatcher-Groover-Schwartz House P.L. Hay House Rose Hill Cemetery Holt-Peeler-Snow House Sidney Lanier Cottage Lassiter House W.L. Lee House DeWitt McCrary House Mercer University Administration Building Militia Headquarters Building Monroe-Dunlap-Snow House Monroe-Goolsby House

Monroe Street Apartments
Municipal Auditorium
Leroy Napier Home
Ocmulgee National Monument
Old U.S. Post Office and Federal Building
Poe House
Randolph-Whittle House
Rock Rogers Home
Slate House
Ralph Small Place
Solomon-Curd House
Solomon-Smith-Martin House
St. Joseph's Catholic Church
Stratford Academy
Villa Albicini
Guy White Building
Willingham-Hill O'Neal Cottage

Bryan County:

Fort McAllister
Seven Mile Bend or Bryan's Neck

Butts County:

McIntosh Inn

Camden County:

Orange Hall

Carroll County:

Bonner-Sharpe-Gunn House

Catoosa County:

Chickamauga and Chattanooga National Military Park

Chatham County:

Bethesda Home for Boys
Central of Georgia Railroad Company
Davenport House
Federal Building and United States Courthouse
Fort Jackson Maritime Museum
Fort Pulaski
Green-Meldrim House
Juliette Gordon Low Birthplace
Savannah Historic District
Scarborough House
Oliver Sturges House
United States Custom House
Wormsloe Plantation

Chattahoochee County:

Riverside

Clarke County:

Bishop House
Garden Club of Georgia Museum
Gov. Wilson Lumpkin House
Old North Campus
Old Lucy Cobb Institute
President's House
Sledge House

	Upton House Wilkins House Lumpkin, Gov. Wilson, House
Clayton County:	Jonesboro Historic District Stately Oaks (Orr House)
Cobb County:	The General Johnston's Line Kennesaw Mountain National Battlefield Park Sope Creek Ruins
Columbia County:	Stallings Island
Coweta County:	Gordon-Banks House
Decatur County:	Curry Hill Plantation
DeKalb County:	Callanwolde Civic Center (Old DeKalb County Courthouse) Soapstone Ridge
Dougherty County:	Municipal Auditorium
Early County:	Kolomoki Mounds State Park
Floyd County:	Chieftains
Fulton County:	Barrington Hall Bulloch Hall "Cyclorama" Fox Theater Habersham Memorial Hall Joel Chandler Harris House Inman Park Martin Luther King, Jr., Historic District Edward C. Peters House Rhodes Memorial Hall Roswell Historic District Tullie Smith House State Capitol Building The Texas United States Post Office and Courthouse
Gordon County:	New Echota
Grady County:	Susina Plantation
Gwinnett County:	Old Seminary Building

Hall County:	Bowman-Pirkle House Federal Building and Courthouse
Hancock County:	Glen Mary Shivers-Simpson House Sparta Historic District
Haralson County:	Haralson County Courthouse
Jackson County:	Crawford W. Long Medical Museum
Jenkins County:	Birdsville Plantation
Jones County:	Jarrell Plantation
Liberty County:	Fort Morris LeConte-Woodmanston Site Midway Historic District Saint Catherines Island
Lumpkin County:	Calhoun Mine Dahlonega Courthouse Gold Museum Price Memorial Hall
Macon County:	Andersonville Prison Site
McDuffie County:	Old Rock House
McIntosh County:	Fort Barrington Fort King George
Meriwether County:	Clarkland Farms Harman-Watson-Matthews House Mark Hall Meriwether County Courthouse Meriwether County Jail Red Oak Creek Covered Bridge Warm Springs Historic District White Oak Creek Covered Bridge
Monroe County:	Great Hill Place
Morgan County:	Bonar Hall Cedar Lane Farm
Murray County:	Fort Mountain State Park Vann House
Muscogee County:	The Cedars Columbus Historic District Columbus Iron Works Dinglewood Goetchius-Wellborn House Gunboats Muscogee and Chattahoochee

Hilton
Illges House
Joseph House
Lion House
Octagon House
Peabody-Warner House
Pemberton House
Rankin House
Senior Citizens Center (McGee-Woodall House)
St. Elmo
Springer Opera House
Swift-Kyle House
Walker-Peters-Langdon House
Wells-Bagley House
Wynn House
Wynnton School Library
Wynnwood

Newton County:

Orna Villa

Oconee County:

Eagle Tavern

Paulding County:

Pickett's Mill Battlefield Site

Pickens County:

Tate House

Pulaski County:

Hawkinsville City Hall-Auditorium

Richmond County:

Academy of Richmond County

Augusta Canal

Brahe House

College Hill

Commandant's House, Old Augusta Arsenal

First Baptist Church of Augusta

Gertrude Herbert Art Institute (Ware's Folly)

Mackay House

Old Medical College Building

Sacred Heart Catholic Church

St. Paul's Episcopal Church

Spalding County:

Bailey (Sam) Building

Bailey-Tebault House

Double Cabins

Goodrich (L.P.) Homeplace

Hawkes Library

Hill-Kurtz House

Hunt House

Mills House

Old Gaisert Homeplace

Old Medical College Historical Area

Stephens County:	Historic Traveler's Rest
Stewart County:	Bedingfield Inn
Sumter County:	Andersonville Prison Site
Talbot County:	Towns (George Washington Bonaparte) House Zion Episcopal Church
Taliaferro County:	Liberty Hall
Thomas County:	Cater House Hayes House Jeffries House Lapham-Patterson House Monro House Scholar House Frances Stone House Thomas County Courthouse Wright House



LAPHAM - PATTERSON HOUSE THOMASVILLE 1885 VIEW

Troup County:	Bellevue Hutchinson Home Nutwood
Walker County:	Ashland Farm John Ross House
Walton county:	Davis-Edwards House
White County:	Old White County Courthouse
Wilkes County:	Arnold-Callaway Plantation Campbell-Jordan House The Cedars East Robert Toombs District Gilbert-Alexander House Holly Court North Washington District Old Jail Peacewood Poplar Corner Toombs House Tupper-Barnett House Washington Presbyterian Church Washington-Wilkes Historical Museum West Robert Toombs District Mary Willis Library



McINTOSH INN, INDIAN SPRINGS

ARCHEOLOGY IN GEORGIA

“The prehistoric [and historic] record of our human past is written in the soil,” says Charles McGimsey. “Everytime an archeological site is destroyed - whatever the reason - a part of our heritage is lost forever.”

This Handbook will do more harm than good we were told by some staunch archeologists who felt that any explanation of sites and excavations would simply encourage droves of people and amateurs to rush out and desecrate Georgia's archeological heritage. Our intention is not to encourage this approach at all, but rather to inform the citizens of this state on the premise that an educated citizenry would be aware of the importance of such a valuable research tool, and handle these sites properly.

Archeology is a research tool. Like any good text, dictionary or encyclopedia archeology is a means of acquiring information. It is one technique for historical, or prehistorical research.

Within Georgia, there are two areas of archeological concern; the cultural remains of the Indians that lived before European contact and the Post European cultural remains of the Indians, Europeans and Blacks.

Georgia's numerous river valleys and over 1000 miles of coastline are an inestimable source of prehistoric and historical data. Archeological data is particularly abundant along waterways and research in these areas is especially important. Research and information is very critical in areas where the necessities of life such as water, arable land or wild food resources are or were readily available: alluvial river bottoms, the oak and hickory forests of the uplands and the coastal areas where marine life provided food.

These are the areas in Georgia that are extremely vulnerable. An archeological site is where you find it, but some areas were more favorable than others for habitation by prehistoric and historic people. Unfortunately for the preservation of archeological resources, these locations are often the same ones favored by us today.

Archeological resources are akin to an endangered species according to Charles McGimsey, Director of the Arkansas Archeological Survey, even more endangered, for no matter how badly we work to protect them, they cannot reproduce or increase. It is generally the case that not every site can be preserved or carefully and completely excavated. Decisions concerning which sites should be preserved, which ones investigated, and the nature and intensity of those investigations must be based on information which can be attained only by an intensive surface and appropriate subsurface investigation. Until this evidence has been evaluated by a professional archeologist, every site must be considered significant.

There has never been nor will there be an opportunity or resources to excavate every site, but it is essential that trained persons be given the opportunity and the resources to determine what information is available in an area and on that basis determine which sites to preserve and which sites to investigate. Archeology is a destroying process because when you dig something up it is gone and what you find is only as good as the care put into retrieving it. A preserved site is always available, and at some later date can be retrieved if and when necessary.

There is a real need for public support and public awareness in preserving these sites. Some very simple and basic guidelines follow and we encourage you to take every precaution and exercise care in treating a site about which you may know.

1. DO NOT DIG! Nothing is saved by digging, and there is no need to excavate every site.
2. Report the location and what you suspect it to contain to a responsible professional authority.

Dr. Lewis Larson, State Archeologist
103 Martha Munro Hall, West Georgia College
Carrollton, Georgia 30117

Dr. David Hally
Department of Anthropology, University of Georgia
Athens, Georgia 30602

Dr. Roy Dickens
Department of Anthropology, Georgia State University
Gilmer Street, Atlanta, Georgia 30303

Dr. Craig Sheldon
Department of Anthropology, West Georgia College
Carrollton, Georgia 30117

Mr. Frank T. Schnell
Columbus Museum of Arts and Crafts
1251 Wynnton Road, Columbus, Georgia 31906

3. Leave the area alone and do whatever you can to insure its protection and preservation.

It is impossible to effectively tell someone how to recognize an archeological site. This recognition is left in the hands of trained professionals; however, many of us have heard of areas or have stumbled onto sites which appear to relate to another period of time. If you find clues such as broken bits of pottery, earthworks, bits of building materials or mounds, DO NOT DIG, contact one of the above people.

If you wish further information about archeological activities in Georgia or elsewhere, or are interested in participating in Georgia's archeological survey contact any one of the above mentioned professionals. They can also supply you with information on professionally supervised archeological field schools where interested students can work under the direction of an archeologist.

There is an on-going survey to record sites in Georgia. The University of Georgia's Department of Anthropology is acting as a depository for the collection of these records. In addition, significant archeological sites in the State are systematically being entered on the National Register of Historic Places.

If you wish to visit an archeological site, the following sites in Georgia have been interpreted and open to the public.

Ocmulgee National Monument near Macon, operated under the National Park Service. Excavations of this site were done in the 1930's and a museum is on the grounds.

Etowah Mounds near Cartersville. Excavations have been periodically taking place since 1953. A museum housing artifacts from the mounds is open and provides an interpretation of the site.

Kolomoki Mounds south of Columbus, a museum is on the site displaying artifacts of the site.

CHAPTER FOUR THE HISTORICAL SURVEY IN GEORGIA

THE GEORGIA SCENE: This historical/architectural survey program in Georgia is largely done in conjunction with the National Register Program by the Historic Sites Survey Staff; however, not all sites surveyed are listed on the National Register. Those sites which do not meet National Register criteria but have other state merits are listed on the State-wide survey which is maintained and available for use in the office of the Historic Preservation Section.

Also, in conjunction with the National Register Survey and the State-wide survey is the Heritage Trust Program. Many sites in Georgia are identified through this program and an exchange of information between the two programs is an on-going process. The Heritage Trust maintains a listing of historic sites and potentially endangered sites which have been evaluated by a Trust Task Force for future state use, either in acquisition or possible restoration funding.

At this time, the Heritage Trust does not provide funds for private acquisition and restoration, but plans have been considered to expand the program to somewhat follow that of the National Register, but on a state level, making more funds available for preservation activities in Georgia. This program has not come about and is still in the earliest planning stages. It will ultimately be up to the Legislature and their approval of funding.

In-put into the historical/architectural survey in Georgia is further provided by the Georgia Trust for Historic Preservation. The Georgia Trust is a private organization made up of concerned citizens in Georgia who have contributed through membership dues. This program largely follows the National Trust pattern, and as the membership increases and funds become available, the Georgia Trust will be more directly involved in preservation activities of all types.

Finally, the historical survey in Georgia is expanded through volunteer and historical society participation. As the backbone to the Georgia Survey, these organizations and individuals have devoted their time and talents to help prepare National Register forms, call sites to our attention and work closely with the State Staff to identify and research sites. Without their past and continued help, the Georgia Historical Survey would not be possible.

ARCHITECTURAL—HISTORICAL SURVEYS

A comprehensive survey of your community's inherited architectural or historical assets is a challenging job, one that requires a great amount of research and foot work, but one that generally leads to the protection and enhancement of the quality and beauty of everyday surroundings. If buildings and whole neighborhoods are worth saving, it is usually because they are worth looking at, worth working in, and worth living in. Historical references per se are important but those associations are due more often than not to the fact that handsome buildings and settings are made by interesting people and in turn attract important events and persons and thus earn historically significant places in the community. As historically related sites are gathered around a particular place,

architecture and history become so inter-related that a site or area becomes the symbol and embodiment of a community's consciousness of itself as a cultural entity.

How, then, is the best way to go about conducting an architectural-historical survey? The first step is to determine what area is to be surveyed; it may be a county, city or merely a district. Next, get a map of the area and as each historic site or structure is surveyed locate it on the map. A map, whether it is a hand sketched one or a geological survey map will be especially helpful, as it will not only show general relationships of the area you are surveying, but will also show on the completed map how the area grew; for example, what portion of the city was the earliest and in what direction it developed from there. In surveying these sites, evaluate them for their architectural and historical significances and at the same time be aware of the general environment. Consider the town plan's design, its gardens, tree-lined streets, fences and even its lamp posts, as well as outbuildings, including barns, kitchens, butteries and privies. Do not overlook old mills, old stores, inns or taverns, covered bridges, historic trails and other early features which may be essentially pioneer and simple in appearance but fragile survivors of earlier ways of living. (Sites where features used to stand but are now wholly or partially gone are excellent places for archeological research and should also be added to the comprehensive survey.) A data form is another aid in this survey work; however, it is only one facet of this data-collecting process. Photographic documentation is an important aspect of a comprehensive survey; see the Structural and Site Survey Form included in this chapter for more details. Permanent safe keeping for all accumulated data is mandatory, therefore, think also in terms of folders or packets in which data can be placed as it accumulates. Keep careful records of your sources of information; for example, you should be able to footnote all dates and house-histories.

A survey's real reason for occurring is the surveyed site's protection, its continued use and its recognition as an object worthy of community respect. At this time, one way to achieve some aspects of this last point is listing on the National Register, the State-wide Survey or the Georgia Heritage Trust Survey. In order that we can have complete and accurate information about your suggested nomination, we are asking that the Structural and Site Survey Form be filled out where applicable, thereby enabling us to better assess the structure, district or site.

The Structural and Site Survey Form used in conjunction with this Handbook is intended to enable you to identify and describe characteristics of sites and buildings. A pictorial glossary of architectural details has been compiled. Please refer to this for appropriate descriptions, and do not hesitate to elaborate or sketch any important or distinctive window, porch, etc. found on your structure, if you do not find the design listed in the glossary. The roughest sketch will be extremely helpful to us. If the area you are evaluating is a site, for example, a battlefield, park, garden, cemetery or Indian mound, describe it as fully as possible including descriptions of any fences, earthworks, archeological evidences, and animal or plant life. Photographs greatly enhance the quality of your survey and we hope these will be included, in duplicate or negative form, with this written form.

An example of the Structural and Site Survey Form follows. Copies of this form are available through the Historic Preservation Section of the Department of Natural Resources, and we encourage you to write or call for them.

HISTORIC PRESERVATION SECTION
DEPARTMENT OF NATURAL RESOURCES
STRUCTURAL AND SITE SURVEY FORM

Name of site or structure _____

Location (include street address, town, county, give directions if rural) _____

Location of Deed _____

Congressional District _____

Acreage _____

Property currently zoned as _____

Longitude and Latitude Coordinates _____

If over ten acres, please provide a plot _____

Original owner (if known) _____

Present owner _____

Present use _____

Perpetuity (Heirs, etc., may be confidential) _____

Original Architect and/or builder _____

Subsequent Architects or builders _____

Condition: excellent, good, fair, deteriorated, moved, altered, added, threatened by
demolition _____

Open to public? _____

Age of structure: give as specific date as possible for original portion of buildings as
well as any alterations or restorations _____

Give your source of information for the above date(s) _____

Representation in other Architectural or Historical Surveys _____

What is the historical background of the site or structure? Include important persons and events. List sources for this information. (Use extra sheets if necessary.)

For a site nomination:

If a site, describe below any earthworks, animal or plant life or archeological evidences. Make a sketch of the site.

For a structural nomination:

Sketch plan of structure and any outbuildings; show any known additions, give dimensions and note northerly direction and front entrance.

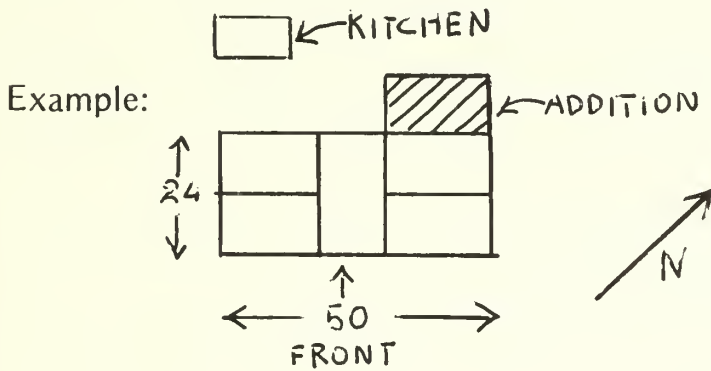

Describe the environment: (On a hilltop, in a commercial or rural setting or in a grove of trees? Is this a one-of-a-kind or is it the best example of several similar ones, etc.) _____

Foundation—Basement:

Height: (level with ground, partially above ground or completely above ground) _____

Building materials used: _____

Main Floors: Wall material (brick; brick stuccoed and scored to resemble stone; stone; wood including log, flush siding, weatherboarded, shingles, board and batton; stucco; marble; concrete; metal) _____

Note any changes from one floor or wing to another _____

If brick, give type of brick bond. (See pictorial glossary) _____

Does the brick bond change in type in any section of the building? How? _____

Type of roof:
(See pictorial glossary) _____

What is the roof material? _____

Type of roof trim? (See pictorial glossary) _____

Number of stories not counting the basement? _____

Give number, location, and material of chimneys: _____

Describe front entrance design: (See pictorial glossary) _____

Describe window types and give number and type of spacing for:

(See pictorial glossary)

basement _____

1st floor _____

2nd floor _____

3rd floor _____

other higher floors _____

attic _____

dormer windows _____

Describe porches:

(See pictorial glossary)

front _____

rear _____

side(s) _____

Describe any outbuildings, giving present and past uses, numbers of stories, style and material used. _____

Describe or photograph interior details including mantels, stairways, wainscotting, door and window treatments. (See Pictorial Glossary.) _____

EVALUATION:

(Discuss architectural merit as well as preservation priority and potential. Try to explain why the structure is significant enough for preservation).

Signature of Recorder

Date

SUGGESTIONS FOR PHOTOGRAPHIC SURVEY

A photograph of the structure on an angle so the side shows, preferably the one with the chimney. If there is an entrance way or architectural detail that you think is significant, take another photograph of the special feature.

A photograph of the rear of the building.

Any section of the structure not covered by the first two photographs. (Be sure you have a good photograph of the entranceway.)

If necessary, take a separate picture, or pictures, of any outbuildings, kitchens, or dependencies.

Interior photographs of significant mantels, stair, door and window treatments.

Specify name of photographer and date of photograph.

TWO COPIES OF EACH PHOTOGRAPH (NO SMALLER THAN 5 X 7) OR A COMPLETE SET OF NEGATIVES MUST ACCOMPANY THIS FORM. (NONRETURNABLE.)

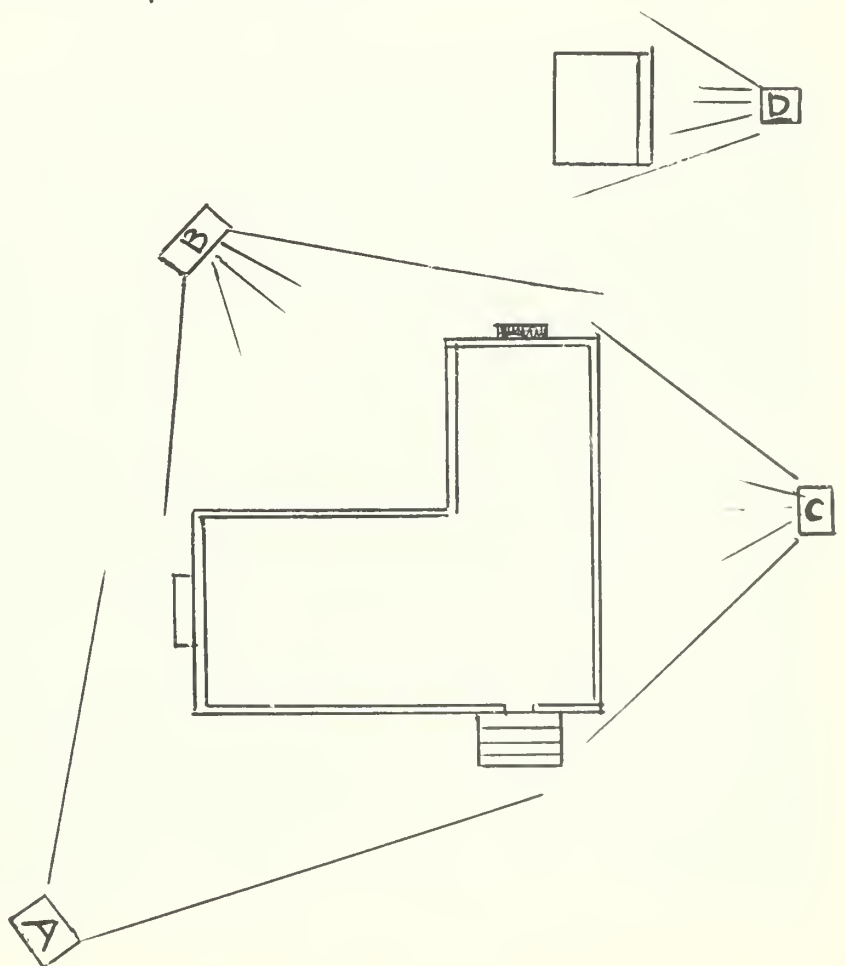

CHAPTER FIVE

SOURCES AND RESEARCH: METHODS

The effective study of local history and site survey work is an essential prerequisite to any worthwhile survey. No isolated structure or site can be truly understood without a complete and accurate picture of the complex which makes up the environment.

Much local research is being conducted and recorded, and many people are interested in it, but so huge is the task that many more are needed. It is hoped this handbook will stimulate new interest and guide the labors of many in this vast and complex program of historic preservation.

In beginning an effective research program, two main points must be considered and evaluated: original and secondary information sources. Original sources include all material which has been preserved from the period you wish to study - written or printed documents, conversations with people who actually lived at the time you are describing, and physical survivals such as mounds, buildings, and relics. Secondary sources are those written by individuals who have studied the original sources. It is obvious that in most cases the original source will be the one to which you will go; however, secondary sources have their advantages in that the material has been defined, interpreted and is a more finished product. The danger in using secondary sources alone is that it does represent someone else's own interpretation.

As a suggested starting point, the following list of sources may provide invaluable information: published histories of your locality and nearby localities, family histories and biographies, military records, directories: county, city and telephone, commercial maps, atlases and gazettes, accounts of travelers, anniversary addresses and sermons, photographs, stories and reminiscences of older residences, private letters, diaries and account books, keepsakes, heirlooms and relics, local newspapers and periodicals, census reports, abstracts and title deeds, old insurance policies, surveyor's notes, school records, public records including probate courts, business records, church registers, denominational minutes and reports, and cemetery inscriptions.

The first nine items are basically library sources and most well equipped libraries should be able to either provide these sources or direct you to other facilities which will be of help such as community organizations which have maintained their own historical records.

The local county courthouse can usually provide you with census reports, abstracts and title deeds, surveyors notes, probate records which include items such as bills of sale, debtors notes, wills and household inventories, and tax records showing property improvements such as major additions or the actual construction of the house on that taxed property.

Interpretation of these sources need not be left in the hands of trained professionals. As you delve into these records, their value becomes obvious, especially if you are seeking a specific piece of information. It only takes a bit of logic to realize, for example, if you are seeking a building date for a house, that a good indication would be a dramatic rise in the property tax from the previous year. Clues are readily available in record and document research and the more deeply you become involved and the more often you use these records the easier it will become to identify your needs and the more expertise you will have. The only word of warning we would offer is that this is terribly contagious and you might find that once you start sharing your "finds" with your friends, those old vaults may not be able to hold the crowds. Document research is fascinating. Try it!

Early carpenter's handbooks should also be considered as a valuable reference source. By comparing these "pattern book" designs with actual cornices, mantels or stair details, clues as to dates of these designs as well as to knowledge of the builder's background can be gained. For example, illustrated in Benjamin Asher's PRACTICAL HOUSE CARPENTER, 1835, is a mantel design, exactly like one in Barrington Hall (1837-42) in Roswell, Georgia.

History may be gathered, written and published either by an individual working alone or cooperatively with a group, but however you choose to go about your research, the Historic Preservation Section encourages you to approach your project with the enthusiasm and dedication historic preservation must have to accomplish its goals.



EAGLE TAVERN EXCAVATION, WATKINSVILLE



CHAPTER SIX

STYLES OF ARCHITECTURE IN GEORGIA, 1733 – EARLY 20th CENTURY

Classification by architectural styles is one method of inventorying, studying, and enjoying Georgia places that have potential for preservation. For the purposes of this Handbook, the history of the architectural styles in Georgia begins in 1733 with Oglethorpe and ends in the early 20th century. During this time span, most of the American architectural styles and building types occurred in some form in Georgia, though not all have survived and are clearly intact. A general guide to the styles, like Marcus Whiffen's *AMERICAN ARCHITECTURE SINCE 1780* can be useful to those who want a broad overview of what happened in the U.S.; but as in most areas that are removed from the urban eastern seaboard, somewhat predominantly rural with scattered patterns of settlement, these general guidebooks to styles are usually only a means of departure because there have been such varied influences on the "pure styles" and so many developments of folk types. An exclusively Georgia architectural handbook is especially necessary since the geographical distribution of styles in Georgia prior to 1860 was based on patterns of settlement which were somewhat different from the rest of the Union. Much of Georgia before the Civil War was a sparsely settled frontier; parts were not even settled until after Creek and Cherokee land cessions of the 1820's and early 1830's. With respect to specific Georgia history, folk building types such as log cabins, farm buildings and plantation plain houses should be carefully studied and are equally as important as the fashionable revivals which are as well represented in Georgia as anywhere in the country.

COLONIAL, 1733 – c. 1785

Description is difficult because few known structures from this period survive. The Mackay House, Augusta, c. 1765, is one of the best documented examples and has been restored as a museum by the State. It is similar to Colonial period houses in New England and the Carolina coast. Although coastal Georgia was settled first, few pre-Revolutionary buildings have survived. Midway Museum, based on carefully researched Colonial Georgia prototypes has been reconstructed by the State of Georgia at Midway, south of Savannah. One definition for the Colonial style in Georgia would be in terms of a time element, pre-Revolutionary,



MACKAY HOUSE, AUGUSTA

because style depended on so many variants as a result of different cultures from which the colonists came.

Mackay House, Augusta, c. 1765

Old Rock House, near Thomson (Old Wrightsboro), c. 1783

PLANTATION PLAIN, 1733 - c. 1860

In an unpublished report written in 1938 and sponsored by the Historic American Buildings Survey, Harold Bush-Brown first hinted that this folk style existed as a separate entity. In 1957 Frederick Doveton Nichols gave the style a name, described and cited a few examples but did not give it a prominent place. Because of the style's fundamental importance to Georgia, this Handbook gives it equal status with other American stylistic terms and makes the following observation: The Plantation Plain Style was the basic "root stock" on which Federal and Greek Revival architectural styles were grafted in Georgia. It originated during Colonial times and persisted sometimes even after the Civil War. Nichols describes this style as:

Simple edifices, mainly plantation houses and their dependencies, of wood covered with weatherboard topped with a simple gable and chimneys of masonry or clay, we call the "Plantation Plain Style." Its simple interiors are usually partially or completely sheathed with matched boarding and without cornices and with the simplest of door and window trim.



OLD INN, MORGAN COUNTY

More specifically the term Plantation Plain is used for a two story frame house, one-room deep, with a two-over-two room plan and a shed porch; for a one story, or one and a half story similar structure, the term plain style, one story. . .etc. would be used. A descriptive definition in this latter case would be sufficient.

Cultural geographers and folklorists refer to this two-story, one-room deep house as the Virginia "I" house and it is a common feature throughout the Piedmont, up-country South.

PLAIN STYLE VARIATIONS

Thornton House, Stone Mountain Park, c. 1785

Eagle Tavern, Watkinsville, c. 1795 - c. 1820

Travelers Rest, near Toccoa, c. 1815 - c. 1820

Tullie Smith House, Atlanta, c. 1840

PLANTATION PLAIN STYLE, FEDERAL DETAILS, c. 1790 – c. 1830

Parker Callaway House, Washington, c. 1790

Dell-Goodall House, Sylvania, c. 1810

PLANTATION PLAIN STYLE, GREEK REVIVAL EMBELLISHMENTS, c. 1825 – c. 1850

Campbell-Jordan House, Washington, c. 1808, 1818, 1850
(Federal and Greek Revival features combined)

Bonner-Sharpe-Gunn House, Carrollton, c. 1830

Liberty Hall, Crawfordville, c. 1835

FEDERAL, 1785 – c. 1830



WARE-SIBLEY HOUSE - AUGUSTA

FEDERAL, 1785 – c. 1830

The Federal style was ultimately derived from the delicate classicism of the Adam style in England. Usually Federal style details were applied to a Plain style structure but important exceptions to this rule may be found in the work of Daniel Pratt in Milledgeville and that of other builder-architects in LaGrange and elsewhere. As a general rule, however, the Federal style in Georgia was a simplified version of what elsewhere would be far more elaborate. In many cases a fanlight over the door and sunburst mantel pieces are all that one can call Federal style about Georgia architecture during this period.

Vann House, near Chatsworth, c. 1805

Gilbert-Alexander House, Washington, c. 1808

Davenport House, Savannah, c. 1812

Ware-Sibley House, Augusta, 1818

Gordon-Banks House, Newnan, c. 1828

Nutwood, LaGrange, c. 1833

REGENCY, c. 1816 – c. 1824

This form of late-Georgian, neo-classicism influenced by the work of Sir John Soane most notably occurred in the Savannah work of the English architect, William Jay (1794 - 1837).

Owens-Thomas House, Savannah,
c. 1816 – 1817



OWENS-THOMAS HOUSE, SAVANNAH

GREEK REVIVAL, c. 1830 – c. 1860

During the boom years prior to the Civil War, Doric, Ionic and Corinthian columns and other Greek Revival ornamentation transformed the face of Georgia. The style was manifested either as details added to existing structures, temple form porticoes, or as an

entire Greek Revival temple form with columns sometimes going around the entire structure. Plain style houses were often adapted to the style as well as such other types as the raised cottage.



BULLOCH HALL, ROSWELL

FULLY REALIZED GREEK REVIVAL

Old Governor's Mansion,
Milledgeville, c. 1838

Bulloch Hall, Roswell,
c. 1842

U.S. Customhouse, Savannah,
1847-50

Dearing House, Athens, 1856

ONE STORY GREEK REVIVAL

Adams-Hume House, Eatonton,
antebellum

RAISED COTTAGE, GREEK REVIVAL

Holly Hill, Roswell, 1842-7



HOLLY HILL, ROSWELL

GOTHIC REVIVAL, c. 1840 – c. 1870

Of the parade of 19th century revivals, the Gothic Revival was second only in popularity to the Greek Revival, for it provided a refreshing antidote to the sometimes heavy classicism which dominated the landscape. The symmetry so essential to the classic style gave way during the Gothic Revival to a taste for visual picturesqueness, and a growing desire for more freedom in laying out floor plans. Usually, one or more of the following elements occurred: an emphasis on the vertical, with pointed arches, clustered



BLYTHEWOOD, CLARKESVILLE

columns, or uneven skylines of spires, towers, turrets and crenellated battlements. As with Greek Revival embellishments applied to plain style houses, Gothic ornament was also added to already existing houses. During this Gothic Revival period, several popular stylistic off-shoots developed. These can be termed Carpenter Gothic, referring to A.J. Downing's cottage type with gingerbread bargeboard, eaves, etc.; and Steamboat Gothic, characterized by the rhythmical wooden pattern of porch brackets and balustrades. Another variant was the Tudor Gothic with castle-like features, an excellent example of which is cited below.



RICHMOND COUNTY ACADEMY, AUGUSTA

Zion Episcopal Church, Talbotton, c. 1850 (English Rural Church Gothic)

Blythewood, near Clarkesville, c. 1855 (Carpenter Gothic)

Green-Meldrim House, Savannah, 1856 (Gothic Revival)

Richmond County Academy, Augusta, 1856-57 (Tudor Gothic Revival)

McCrary House, Wrightsville, 1880's (Modified Steamboat Gothic)

ITALIAN VILLA STYLE, c. 1855 – 1870

The 19th century was a century of revivals, and the Italianate does not have a better representative in the nation than Macon's Hay House, a National Historic Landmark. Generally, this style is noted for bold contrasts of irregular, rectangular masses of main house and towers, broad extending eaves, usually bracketed, picturesque combinations of arches, columns, pediments and balustrades that reflect the Italian villa in terms of the Victorian era.

Dinglewood, Columbus, c. 1855

Hay House, Macon, 1856



HAY HOUSE, MACON

OCTAGON STYLE, c. 1840 – c. 1860

Inspiration for the Octagon Mode of building came from O.S. Fowler's book, *A HOME FOR ALL; OR THE GRAVEL WALL AND OCTAGON MODE OF BUILDING*, 1848. The Octagon Mode follows the plan of a regular octagon and is usually one or two stories in height. The roof is flat or low and is often topped by a belvedere. Often surrounded by a verandah, but sometimes only a porch to the front door, the Octagon is either plain or embellished with Greek Revival, Italian Villa, or Gothic Revival details. Like covered bridges, Octagon style houses are rare. Georgia's most well-known Octagon is May's "Folly" in Columbus. During restoration, the rear wing was discovered to have been originally octagonal, thus revealing the structure as a rare double octagon type and probably the only one in Georgia, if not the nation.

May's "Folly," Columbus, c. 1863

HIGH VICTORIAN: ROMANESQUE REVIVAL, SECOND EMPIRE, QUEEN ANNE, EASTLAKE, STICK AND SHINGLE, c. 1870 – c. 1900

"High Victorian" may be used in a general way for most of the architecture of the 870's, 80's and 90's in this country. The five styles above have been combined here as they were often combined in single designs during the period.



MAY'S FOLLY - OCTAGON HOUSE, COLUMBUS



A Suburban Home: (The "Home")
Wm. M. W. M.
Home Bldg.
Wm. M. W. M.
Wm. M. W. M.

Forms from different sources in the past were often brought together so creatively that today the era's eclecticism, or mixing, is often appreciated as a style itself. The "Shingle Style," for example, is thought to be a creative eclecticism, growing out of Queen Anne, which became a separate entity. (In Georgia, most of what might be called "Shingle Style" is well-designed Queen Anne.) This was the era of the formation of the architectural profession and such figures as Atlanta's G.L. Norrman, designer of the Edward C. Peters House, designed buildings during this era which can be variously classified as Queen Anne, Romanesque and even just plain "Victorian." Some of the best work done in Georgia during this period occurred in Savannah where W.G. Preston of Boston made a "rich melange" of materials and forms perhaps ultimately inspired by the Arts and Crafts Movement of such Englishmen as William Morris and Charles L. Eastlake for whom the Eastlake style is named.



LAPHAM - PATTERSON HOUSE

The Lapham-Patterson House in Thomasville provides another fine example of this era.

QUEEN ANNE, EASTLAKE, STICK AND SHINGLE

Wren's Nest, Joel Chandler Harris Memorial, Atlanta, c. 1881

Edward C. Peters House, Atlanta, c. 1885

Lapham-Patterson House, Thomasville, 1885

Cotton Exchange, Savannah, 1886

Dickey-Beath-Griggs House, Atlanta, 1889

ROMANESQUE REVIVAL

Shrine of the Immaculate Conception, Atlanta, 1869

Chatham County Courthouse, Savannah, 1889

SECOND EMPIRE

Hamilton-Turner House, Savannah, c. 1870

Hatcher-Groover-Schwartz House, Macon, 1880

EARLY 20TH CENTURY

Georgians, like the majority of Americans, entered the 20th century with firm, rather conservative ideas about what constituted good architecture. Because most people continued to admire past styles as sources of design, revivalism continued. In the field of domestic or residential architecture this was particularly true. The form, plan and details of a house were often borrowed almost literally from a model out of the past - often on a larger scale than the original. This 20th century revivalism was usually even more well-informed and archaeologically correct than before. However, the ideal was not to copy but to use historical precedent as a source of inspiration. Architects often designed within a given style almost as well as those who originated the style. University architectural departments were developed, turning out a professionally trained person who was stronger in design than engineering and was oriented towards historical forms and styles



CANDLER BLDG. ATLANTA

rather than technology and function. Many teachers and students of architecture studied at the Ecole des Beaux Arts in Paris, France, to learn design based on classical French precedents. Skyscrapers and warehouses often looked like versions of Versailles. But even so they were usually interesting, well-built, and finely detailed; some were, and still are, extraordinarily appealing - even more than the historical models which served as inspiration for ornaments, details, plans and forms.

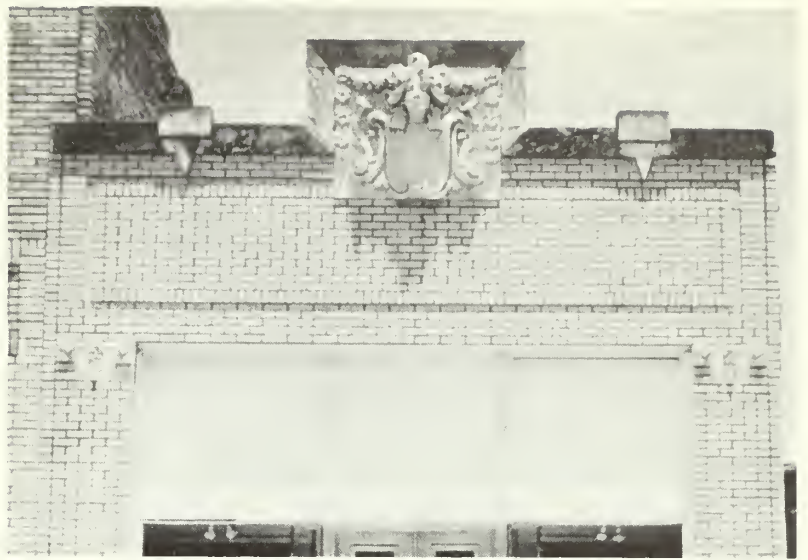

HAT SHOP, HAWKINSVILLE

Beginnings of new attitudes, however, towards design which would lead to relative freedom from the traditional styles were seen as early as the 1870's, particularly in the mid-West. As early as 1900 the so-called Chicago School of Architecture with its "Prairie houses" and commercial buildings, especially skyscrapers, began to have a degree of national influence. There were other pockets of new architectural thinking, for example, the California work of the Greene brothers, however, in Georgia little of this influence was felt; most people preferred the very best conservative, traditional, and academic type of design and got it, as the examples will show.

- The Crescent, Valdosta, c. 1900 (Neo-Classical Revival)
- Candler Building, Atlanta, 1906 (Commercial)
- Walker-Moore House, Sparta, c. 1915, Greene brothers (Bungalowoid)
- Callanwolde, Atlanta, 1917-21 (Tudor/Gothic Revival)
- The Hat Shop, Hawkinsville, c. 1920 (Sullivan-esque)
- Fox Theater, Atlanta, 1927 (Moorish/Byzantine Revival)
- Edward H. Inman (Swan) House, Atlanta, 1928 (High Renaissance Revival)



SWAN HOUSE, ATLANTA

CHAPTER SEVEN

PRESERVATION, RESTORATION, RECONSTRUCTION AND REHABILITATION

In the 1960's and 70's historic preservation has become more concerned with community planning and less with pure history. No longer mainly saving a few super historical sites, historic preservation now concerns itself with all manmade evidences of the past - individually and collectively - that by age or character contribute to the total environment. Thus, an old building or group of buildings, or public square that lends dignity and stability to a community is given a priority to be saved for its association with earlier generations and the foundations of the community. Preservation of historic structures, objects and sites is fundamentally tied, in other words, with continued use and function. Uses which are not detrimental to the basic integrity of structures as architectural and historical documents are heartily encouraged. Communities have discovered that urban renewal does not have to mean wholesale destruction of older neighborhoods and that rehabilitation is a better choice of options. Whole districts become a focus of attention as opposed to single structures. These single structures are then viewed as a part of the whole.

Historic structures or sites are accorded a variety of methods of treatment depending upon their significance. Preservation, restoration, reconstruction or rehabilitation are different approaches that can be taken for a complete historic preservation program.

Preservation aims at halting further deterioration and providing structural safety, but does not necessarily imply significant rebuilding. It includes techniques for slowing the deterioration of a structure, the improvement of the conditions in the structure or site to make them safe, habitable or otherwise useful, and normal maintenance and minor repairs that do not change or adversely affect the architectural and structural fabric or historic appearance.



WHITE OAK CREEK COVERED BRIDGE, MERIWETHER CO.

The process of accurately recovering earlier and/or original form, style and plan by removal of later work and the replacement of missing work is considered restoration. Restoration of the form and details of a structure and site or part of a structure, together

with its setting as it appeared in some period of time, is the goal. Restoration can also be a partial program whereby only a particular stylistic aspect of a structure or site — external, internal or in combination — is undertaken. Adaptive restoration is generally the treatment for structures that are visually important in the historical scene but in which economics will not allow for continued use as originally intended. In such cases, the facade is usually restored to achieve original appearance while the interior is converted to a modern functional use without impairing original architectural character. A more detailed discussion of this research is included in Chapter Five.



TRAVELERS REST, TOCCOA



NIT SHOP AND COURTHOUSE - NEW ECHOTA, CALHOUN

Reconstruction accurately reproduces by new construction the form and details of a vanished structure or site in part or in whole as it appeared at some period of history.

Rehabilitation is a complete revamping of an area or structure either in part or in combination with preservation, restoration and reconstruction. Usually urban goals will provide for a complete rehabilitation program to lend new impetus to economically and structurally deteriorated neighborhoods by stressing neighborhood historical heritage and new feelings of responsibility and commitment in a rejuvenated neighborhood, especially through the adaptive use of the older, historical structures.



PETERS HOUSE, ATLANTA

Preservation is the treatment to be considered first; however, when needed, historic sites and structures may be fully and exactly restored. Reconstruction should be considered only when all or most of the traces of a site or structure have disappeared and its rebuilding is essential for public understanding and appreciation, and when significant historical data exists to permit an accurate reproduction. Only rarely would a reconstruction be made on other than the original site.

The preservationist, amateur or professional, today relates to the process of contemporary life more than ever before. He thinks of his work as an integral part of the community development process and does not hope to turn back the clock except for educational purposes. The beauty of saved buildings and neighborhoods he sees as a very real contribution to the everyday life of his community, providing an appreciation of a cultural pattern from which he has evolved.



INMAN PARK, ATLANTA

RESTORATION PHILOSOPHY

Restoration is one of the most important and technical aspects of historic preservation; however, the various preservation philosophies as well as individual needs lead to differing interpretations of the restoration process. Before any restoration is begun, these philosophies should be clearly analyzed so that the approach most suitable for the particular situation is appropriately recognized and used.

The most generally understood method of restoration, termed pure or complete restoration, is that of accurately recovering an original and/or early form, style and plan by removal of later work and replacement of missing work. This restoration approach is founded in part on the assumption that the most important factor in preservation is to recapture a specific design, usually the original or early one, and as a result, any later additions or revisions that detract from this design should be removed. This approach is often taken when a specific event or monumental time period is needed to be set aside for special emphasis.

Much timely and extensive research of written and graphic records as well as into the structure of the building - a form of archeology - is necessary. Personal diaries, letters, old photographs, courthouse records as well as an analysis of the building's structure, materials used (such as testing for early paint samples, noting types of nails used) and recognizing structural and detail changes in the plan, flooring or cornices, etc. are important tools to the restoration process. The restoration study needs to be carefully documented photographically, researched and analyzed in order to recreate the total time period in which the structure is being placed.

Although the research process is essential to any restoration, the use of the end result is open to interpretation. Another preservation philosophy is that of basically no restoration, formed on the premise that the design of a structure at one point in time is not necessarily the most important, all-encompassing factor that needs to be preserved. This is because any changes in the fabric of the building would be changes in the historic reality that acts as a direct transference of the past into the present - a transition that often has just as valid a place in preservation as the more monumental-seeming, limited time period of specific significance. Many years of human history might be destroyed by a strict time-limiting design oriented restoration that removes a Victorian porch from a Greek Revival structure or replaces a window that later occupants found necessary to use as a doorway.

Any change for the sake of necessity or taste can be a valid cultural statement whether rendered 150 years ago or today. And it is for this reason that recognition should be given to those adaptive use restorations and also those that merely strive to perpetuate and stabilize a spirit or a reference to the former style of a particular building by standards less strict than those observed in a museum restoration. Some of these less strict, restorations may be termed cosmetic restorations or remodelings. "Some Notes on the Treatment of Details" which follows in this chapter offers suggestions for this type restoration.

GUIDELINES FOR BEGINNING A RESTORATION

At some point in the early stages of the restoration process, the following should be investigated.

1. Consult an architect sensitive to historic preservation needs and decide on a restoration approach. If no consultant is to be called in, by all means familiarize yourself with restoration techniques. (Check the bibliography.)
2. Photograph everything. Generally black and white photographs will suffice for construction and architectural details; color photographs should be used to record the landscape, wall paper or original paint colors. Take measured photographs (i.e. - have a yard stick in each photograph to record actual dimensions of details) of doors and windows trim, cornices, wainscotting, flooring, stairs, etc. Document any uncovered structural details as well as construction of attic and basement and all exterior facades.
3. Great care should be taken in the initial, enthusiastic clean-up of the site. Be alert to any derelict materials which may have been a part of the building fabric. Note any walkways, foundation remains, garden areas in the yard and be especially careful not to destroy or throw away any structural remnant, such as an old door or shutter long ago relegated to attic storage. All of these may at a later time aid in the understanding of the property's past.
4. Do not move the structure unless it is absolutely necessary to the building's survival. Much can be found historically and culturally from the original location of the structure as well as possible artifacts that archaeological excavations may find to enhance the restoration's authenticity.
5. Stabilization. Try to keep the building in its existing form while at the same time taking measures to prevent further deterioration. If the structure is in dire need of immediate protection from the elements, cover roof and windows with temporary tar paper and masonite until restoration can begin.

If a brick or stone structure leaks or disintegrates, these areas should be repointed. Do not use modern portland cement. It is impossible to remove at a later date if incorrectly applied and it is subject to shrinkage and will continue to cause leakage. For these reasons lime mort or hydraulic cements are better to use in repointing. If the brick surface is in need of cleaning, a chemical cleaning solution is preferable as sandblasting often causes the brick surface to become porous.

Before removing any paint or repainting, record all layering of color; it is best to save some actual painted member that can be referred to later. Take paint scrapings. These can indicate an early color scheme as well as be a dating tool. The number of layers on members installed at different time would vary and thus give some indication of later work.

6. Thorough research of the building from a structural as well as a documentary standpoint should be conducted before actual restoration work begins. Check courthouse records, personal diaries, travel accounts, etc. as well as conversations with older residents. Compare the mill work craftsmanship and design to similarly designed and contemporary structures in the area.

It is understandable that not everyone has need of, or wants to preserve their particular structures as a museum piece or even restructure their property to some specific time period. Our needs change and structures need to have adaptive uses. This is a valid position to take so long as it is understood that it is not a pure restoration, rather one that can be called a cosmetic restoration or remodeling. The following article is an excerpt from the booklet "Revitalizing Older Homes in Charlestown," an HUD publication that will help to guide you in such a restoration.

SOME NOTES ON THE TREATMENT OF DETAILS

The following notes are for the guidance of those who want to make the best possible job of restoring or remodeling their house with whatever money is available, but may be in some doubt as to how the individual details should be treated - or are simply confused by the over-choice of standard building parts on the market.

When working on older houses there are three basic rules to good design.

1. If in doubt, try to retain as much of the original materials, detail and design as the budget will allow.
2. If introducing modern parts or mixing old and new elements on the outside of a house, make sure that its character is not spoiled in the process and, if possible, get some advice from a good architect with experience in such work.
3. Never try to make a building look older than it originally was by using details belonging to a previous period: this is not true restoration and the end results will never look completely genuine.

The last rule is a very important one and deserves further explanation. Until recently, nineteenth century houses tended to be regarded as "old-fashioned" rather than "old" and were often despised both by architects and the public. For this reason, when remodeling occurred, they were usually dressed-up to look as if they had been built in some earlier and more respected period such as the Colonial or the Federal. With the rediscovery of the very real virtues of Victorian architecture, however - especially in comparison with much that is built today - the nineteenth century house is at last being valued for what it is, and its many and varied styles seen as a vital and interesting part of our architectural heritage. It is unnecessary, therefore - and undesirable - to add false "history" to a building by imitating the details of older styles: the results are nearly always unconvincing and detract from the building's true character.

With these guidelines in mind we will discuss some of the more common problems that face the homeowner when remodeling, under the separate headings of Materials, Use of Color, Windows, and Doorways.

MATERIALS

It is a safe rule, generally, that nothing is going to look better than the materials in which the building was originally designed.

Brick walls, for example - unless they are of an unusually unpleasant color - should never be covered with any form of artificial siding. This is not for esthetic reasons only, for, whatever salesmen of artificial siding may say to the contrary, a brick wall is generally one of the best bargains in terms of maintenance; it may cost as much to repoint it as to cover it up with, say, asphalt shingles or artificial stone, but the end result will last at least three times as long as well as looking about a hundred times better!

Nothing can match the beauty of a richly-textured brick wall, and for this reason it is often better to use a grey or darker-tinted mortar when repointing so that the wall itself is emphasized rather than the individual bricks. (When a light-toned mortar is used, each brick seems to stand out separately as a dark "island" in a white "sea".) The use of darker mortar may also be appropriate when introducing areas or panels of new brickwork into a remodeling job, where it often helps the new work to relate better to the old by producing a similar richness of effect - even if the color of the bricks may be quite different.

A type of brick work to be generally avoided is that which tries to produce a sort of phoney "rustic" effect by using bricks of highly contrasted colors and tones - usually with an occasional white, or near white brick thrown in as if by accident. The general effect often tends to be that of a heap of bricks rather than that of a wall. . . .

If existing brickwork is to be successfully matched, all the following details must be duplicated in the new work:

1. The color, texture, and size of the bricks themselves;
2. the width of the joints between the bricks;
3. the color and tone (degree of darkness) of the mortar in the joints;
4. the type of joint (whether it is flush with the wall or raked back to form a groove).

The owner of a wood frame house is, of course, faced with a much greater range of choices which can be made concerning external materials and colors. The relative merits of wood, aluminum, and vinyl clapboard siding, for instance, may have to be weighed, as well as the possibility of many different color schemes. Again, nothing is going to look better than the material for which the house was originally designed, and if this happens to be wood siding there is a strong case for retaining it or replacing it with the same material (taking care to see that the spacing of the horizontal lines, or laps, is the same as that of the original). Synthetic clapboarding in aluminum or vinyl however - although more expensive and no improvement in appearance over wood - is sometimes used for

maintenance reasons because it needs no painting. These materials are often blamed for spoiling the character of older houses but it is only fair to point out that it is not the materials themselves but the way in which they are used that is usually the real cause of this. Details such as corner boards and the flat trim round windows and doors are removed in the course of the work and either not replaced, or replaced by thin metal equivalents, which give a totally different expression to the building. (Anyone who doubts the importance of small details in establishing character should try shaving off his eyebrows!) If we remember that aluminum and vinyl clapboards are imitation materials and never let them do things that wood clapboards couldn't do, however, we can't go too far wrong; they should always run horizontally, for instance, and should not suddenly run vertically over a curved or projecting feature such as a bay or bow window, unless the siding in the original design did; also, they should not run continuously round the corner of a building, but should be trimmed by an adequately-wide corner plate.

Generally speaking, when using synthetic clapboards, if the spacing of the horizontal lap lines is kept at about four inches, as in the original wood boards, and if the essential details such as the original flat trim around the windows and doors, and the corner boards, are retained or replaced by something similar, the character of the original design need not be spoiled.

On the practical side, synthetic clapboards do have certain disadvantages which should also be considered before deciding on their use; aluminum can be dented and scratched quite easily - and permanently - and both aluminum and vinyl can not be painted over successfully. This means that although vinyl may be "final" so is the color of your house, and if a wrong choice is made the results will be around for a long time! Even greater care than usual must be taken, therefore, when selecting colors in these materials. (See next section.)

Many houses are covered with wood shingles. Sometimes these were part of the original design but often they were added later over the original clapboards or in place of them. Although they are a perfectly acceptable building material in themselves, if they have to be removed as part of the rehabilitation of the house it is often best to replace them with clapboards - with, of course, the appropriate detailing as discussed above - unless there is evidence that the house originally had shingles.

The whole range of asphalt and asbestos shingles or siding should generally be avoided if we are interested in preserving the appearance (and the value) of a house. At best, they have a rather cheap and temporary look which can devalue not only the house but the neighborhood. This applies even more to artificial stone and brick sidings which, in addition, make an unsuccessful pretense of being something which they are not.

USE OF COLOR

One of the most important decisions a house owner may have to make is the choice of exterior colors. This is of particular importance in the case of a wood frame house, where the combination of wall and trim colors usually decides its basic character, making it appear either cheerful or gloomy, light or heavy, restful or "busy", etc. In the case of a

brick building, although the basic wall color has already been established, the choice of color for windows, doors, trim, etc., can still have a decisive influence on the character of the exterior. If no paint scrapings are taken or no documented references are available, the choosing of colors becomes a very personal thing; but, nevertheless, has its effect on the general character of the street. A good color scheme, therefore, should be neighborly as well as effective in itself, so that both the house and the environment benefit.

Whole books can, and have, been written on the subject of the use of color in buildings but, for present purposes, the following brief suggestions may be of help to the homeowner confronted by the very real problem of having to make a choice from dozens of tiny color samples in paint catalogs:

1. Do not use too many colors. Oddly enough, the most effective architectural color schemes usually contain a very limited number of real colors - perhaps one or two at the most - many of the elements such as windows, trim, roofing tiles, etc., being in white, grey, or black which are actually non-colors.

2. If you have a frame house, be very careful in choosing the basic wall color (especially if using aluminum or vinyl clapboards as already noted). White (or rather off-white) nearly always looks right on a clapboard house, but sometimes a darker-toned color can also be very effective - especially if the window trim is off-white or very light in tone. For this the muted or "natural" colors such as gull-grey, grey-blue, slightly greyed yellow ochre, or brick red, are especially appropriate for the New England climate as they look attractive in all seasons of the year. On the other hand, many of the pastel colors such as pale violets and purples, pale green, and pinks tend to look slightly discordant without a tropical sky as a backdrop, and often do not relate happily with the rest of the street.

3. Avoid definite colors when choosing roofing materials which are visible. Often the roof is not thought of as part of the color scheme of a building, and many otherwise effective color combinations have been spoiled by the introduction of green, violet, or pink-tinted asphalt shingles, which turn out to be the straw that breaks the camel's back! Over-colorful roofs also have the undesirable effect of drawing attention away from the more important parts of the building. Neutral grey roofs, on the other hand, will allow a much wider selection of colors on the lower parts of the house - where it really counts and provide a sort of safety buffer against "over-color." The darker tones of grey, such as charcoal (which could almost be called off-black), are particularly effective as a replacement for the traditional slates and look well in themselves besides combining with almost any color. (Despite rumors, a dark roof does not seem to draw any significant amount of extra heat into the house in summertime.)

4. If in doubt, paint the moving parts of the windows white or off-white. This gives life to the exterior by contrasting with the glazed "hole" of the window which is usually black in effect, and also looks well from the interior, helping to reflect light into the room. It is often also appropriate to follow through by painting the rest of the window, including the outer trim, in white.

5. Reserve the use of bright colors for elements of maximum importance such as the front door. Although the front door, or doors, may also look attractive in natural or stained wood, if the surface has to be extensively patched or repaired, the most appropriate finish may be a few coats of relatively brightly-colored paint.

When selecting colors for a house it is often difficult to visualize exactly how the color which appears on the small sample in a paint catalog will look when applied to a whole wall, and how it will relate to other contrasting colors or to black and white. Also, such questions arise as whether such items as window trim, corner boards, downspouts, etc., should be painted to match, or to contrast with the wall and whether shutters or blinds should be used. One of the best ways to decide these questions and to get a good idea of how the final result will look is to make a simple flat model which roughly resembles the front of the house, out of cardboard or hardboard and to paint it with the intended colors. One of the advantages of such a model over a drawing is that the different parts such as the window trim, eaves, and corner boards can be painted separately and put together afterwards. Also, by making these parts removable, the different effect of painting, say, the window trim white, or the color of the surrounding wall if different, can be compared easily.

In such a model it is not necessary that all the details of the real house be reproduced - only that the areas which might be in different colors be represented roughly in proportion, i.e., that the width and size of the window trim, cornices, corner boards, etc., are approximately right. The paint color, also, must be accurately matched and this, of course, can best be done by using some of the paint to be used on the real house. Sometimes this is only obtainable in gallon cans - rather more than needed for a model - but the houseowner can console himself with the thought that if it proves to be the right color, the rest can be used on the real house and, if not, it was still cheaper to find out this way than by painting the whole building!

WINDOWS

Windows give character to a building in much the same way as the eyes do to a human face and are, therefore, a very important element to be reckoned with when determining what a house is going to look like from outside. It is a good basic rule that, if the original windows cannot be saved and it is necessary to replace them, the new windows should be the same size and type as the originals; in other words, they should fill the whole aperture. This is not usually possible when using standard-sized units from a catalog but, if a little extra money is to be spent on a job it couldn't be used in a better way than by buying made-to-measure windows that fit the original openings. (In any case, the difference in price between standard and made-to-measure windows is now often negligible.) The practice of "blocking-up" or "blocking-down" existing window openings to fit a smaller standard window should be avoided, as it does more than any other single thing to change the basic appearance of a building - seldom for the better.

For this reason, also, every effort should be made to keep new ceilings above the level of the heads of existing windows. Windows are often blocked-down to conceal the edges of lowered ceilings. If it is considered absolutely necessary to lower a ceiling beyond the window head, some way should be found of retaining the full height of the windows. Sloping the ceiling at the window is the better method, as it allows more light to enter the room and looks better from the inside, but the solution can also be found acceptable if

the small vertical face which conceals the lowered edge of the new ceiling is kept as far back as possible from the glass and is painted either black or charcoal grey to make it as invisible as possible from the outside.

There are so many types of windows available on the market that, if windows have to be replaced in an older house, the owner may find himself genuinely confused as to what to select. The following suggestions may be of some help.

Generally, the "double-hung" (or vertically sliding) window should be a first choice when selecting new windows for mid-nineteenth century structures, not only because it looks right in these buildings, but because it usually does the best job of keeping out the weather. Also it was customary to divide each of the moving sashes into two parts by a vertical muntin and, in nine cases out of ten this "two-over-two" window is the correct one to use when restoring the building to its original design. For fuller visibility and ease of maintenance, however, the "one-over-one" type, which has one large pane of glass in each of the moving sashes, is often used when the building is simply being rehabilitated rather than restored.

There are also a certain number of buildings in the Federal and Greek Revival styles which were built before 1850 and would have had "six-over-six" windows.

It should be pointed out however that, although appropriate in houses built prior to 1850, "six-over-six" and other small-paned window types should not be used when remodeling or restoring buildings of the latter half of the nineteenth century, unless documentation supports otherwise. This is a common way of "dressing-up" buildings to look older than they actually are, and many people find the temptation too hard to resist; nevertheless it should not be done if the integrity of the building is to be respected. (The type of clip-on subdivisions which are removable for easy cleaning should also not be used, whatever the age of the building if we want it to look genuinely anything, these being pure "fancy-dress" and about as real as a plastic Pilgrim's hat!)

Before leaving the subject of windows a few words must be said about shutters and blinds. (Both are usually referred to as "shutters," but strictly speaking only those with louvers should be called "blinds.") Although used nowadays almost exclusively for decorative effect, external blinds - if they really work - are still one of the most effective ways of keeping a room cool by intercepting the sun's rays before they reach the glass of the window - a fact which may prove useful in certain locations. Whether they actually hinge or not, however, if we are to use shutters or blinds it is of the greatest importance to the appearance of the house that they should look as if they could work - in other words, that they would be big enough to cover the entire window if closed.

Another point about shutters and blinds is that, unless the width of wall between the windows is at least that of the windows themselves, they cannot be used. Otherwise, if there is plenty of wall space in relation to window the appearance of the house may be enhanced by the use of shutters or blinds, if they are properly sized and reasonably "authentic."

DOORWAYS

Nothing looks better than the original door, or doors, at the head of the steps and so every effort should be made to save them, and refinish them if necessary. A wide range of finishes is possible, from clean or stained natural wood to relatively bright colored paints - although very glossy finishes should be avoided, as they reflect too much light and detract from the effect of the color or wood grain, and also show up every minute imperfection on the surface of the door.

CHAPTER EIGHT

GLOSSARY OF ARCHITECTURAL TERMS

The following list of terms will be helpful in evaluating and describing structures found in Georgia. Following is a pictorial glossary of architectural details.

Acanthus.	Ornamental leaves on the Corinthian capital.
Anthemion.	Greek architectural ornament in the form of a stylized honeysuckle flower.
Aperture.	Any opening such as a door or window.
Arcade.	A range of arches supported on piers or columns attached to or detached from the wall.
Arch.	Wedgeshaped stones or bricks set in the form of a curve.
Architrave.	The lowest part of an entablature, sometimes used by itself as around a window or door.
Baluster.	(Sometimes Bannister) A turned or rectangular upright supporting a stair rail.
Barge Board	A stylized rafter set out a little from the clapboards of a gable, used especially on Gothic Revival cottages.
Batten.	A board, narrow or wide, nailed on the back of two or more other boards to hold them together as in a door made of sheathing.
Bay.	An angular or curved projection of a room, usually with windows.
Beaded Weatherboard . .	A weatherboard finished with a projecting, rounded edge.
Belvedere.	A tower or turret with an open porch, built for the sake of the view, or for its own appearance sake.
Bolection Molding.	A heavy convex molding often surrounding Colonial period fireplaces.
Bond.	The pattern in which bricks are laid for the sake of solidity and design. In Georgia four basic bonds were used. English: rows of ends, or headers, alternate with rows of sides or

stretchers. Flemish: headers and stretchers alternate in each course with the center of each header over the center of the stretcher below. American: rows of four or five stretchers between rows of headers. Common: American Bond without a course of headers.

- Bracketing. A supporting piece of wood or stone used to carry the weight of a projecting member.
- Buttress. A mass of masonry or brickwork projecting from or built against a wall to give additional strength.
- Cantilever. A projecting beam or bracket stabilized by the weight of the wall from which it extends.
- Capital. The head of a column or pilaster.
- Casement A window sash that opens on hinges on the side.
- Chair Rail. A molding carried around a room at chair back height.
- Clapboard. See Weatherboard.
- Colonnade A range of columns.
- Composite Order. A classical order with a special capital combining Ionic and Corinthian features.
- Corbeling. A series of short stone or wood projections (corbels) supporting a projection course of masonry.
- Corinthian Order The “rather flowery” order distinguished by a capital made of ornamental acanthus leaves and curled fern shoots.
- Cornice The uppermost, projecting part of an entablature, or a feature resembling it.
- Course A horizontal row of stones or bricks in a wall.
- Crossettes. Decorative square offsets at the upper corner of a door or window architrave.
- Cupola. A dome, especially a small dome on a circular or polygonal base crowning a roof or turret.
- Dado. The plain space in panelling especially wainscoting.

Dentils.	Small blocks in a classic cornice. (See Order.)
Dogtrot Cabin.	(Double-penned cabin) A simple structure, generally log, with two rooms separated by an open breezeway which affords better air circulation.
Doric Order	A classical order with simple unadorned capitals supporting a frieze of vertically grooved tablets (triglyphs) set at intervals.
Dormer window.	A window that projects from a roof.
Egg and Dart.	A convex molding decorated with a pattern of alternate eggs and arrow-heads.
Engaged Column.	A round column attached to a wall.
Entasis.	The very light, slight convex curve used on the shaft of Greek and later columns to correct the illusion of concavity.
Entablature.	Above columns and pilasters, a 3-part horizontal section of a classical order, the topmost part being the cornice.
Facade.	The face or front of a building.
Fanlight.	A window, often semi-circular, over a door, with radiating muntins suggesting a fan.
Finial.	A pointed ornament at a gable peak.
Fluting.	Shallow, concave grooves running vertically on the shaft of a column, pilaster, or other surface.
Fret.	An ornamental pattern cut into or through an open surface.
Frieze.	The middle division of an entablature, below the cornice.
Gable.	The triangular upper portion of a wall to carry a pitched roof.
Gingerbread	Pierced curvilinear ornament made with jig saw or scroll saw much used in the Gothic Revival.
Gambrel Roof	A roof with two sloped or different pitch on either side of the ridge.

Greek Fret.	A running ornament of little mazes.
Graining.	Painted treatment on wood panels simulating patterns of wood grain sometimes to the point of exotic abstraction.
Half-Timbering.	A means of construction exposing the heavy timbers with spaces between beams filled sometimes with brick or a stucco substance.
Header.	The end of a brick, sometimes glazed.
Hipped roof.	A roof with slopes on all four sides. The hip is the external angle formed by the meeting of two roof surfaces.
Hood-mould.	A projecting moulding to throw off rain on the face of a wall above an arch, doorway or window; also called dripstone or albel.
In Antis.	Columns are "in antis" when they stand between square piers call anta.
Ionic Order.	A classical order distinguished by a capital with spiral scrolls, called volutes.
Jamb	The straight side of a doorway or window.
Joists.	Horizontal timbers laid parallel with their upper edges finished to receive floor boards.
Lean-to Roof.	Has one slope only and is built against a wall. (See Shed Roof).
Light	A section of a window, the pane or glass.
Lintel.	A horizontal beam or stone bridging an opening.
Mansard Roof.	A roof with two slopes to all four sides, the lower one being steeper than the upper.
Mantelpiece.	The framed area surrounding a fireplace, usually of wood, brick, stone or marble, frequently including a mantel shelf; sometimes called a chimneypiece.
Modillion	A form of bracket in the cornice of the Corinthian order and of some Ionic orders.
Mortise and Tenon.	A mortised piece of timber has a hole into which the tenon or projecting tongue on another piece of lumber is made to fit.

Mullion	A vertical divider in a window.
Muntin.	The strip of wood separating panes of a sash or casement.
Order.	A definite arrangement of column, capital and entablature, each having its own set of rules and ornamental features. Tuscan, Doric, Ionic, Corinthian, Composite.
Palladian Window.	A group of three windows. The central one is wider and taller than the rest and is round-headed. The two side windows are square-headed.
Pediment.	A triangular space forming the gable of a two-pitched roof in classic architecture.
Piazza	The term used for a veranda in the Colonial period. In Georgia, to this day, a porch may be a piazza.
Pilaster.	A flat-faced representation of a column, projecting from a wall.
Pitch.	The degree of slope of a roof.
Plinth	The projecting base of a wall or column. A large porch having a roof, often with a pediment, supported by columns.
Quoin.	One of the stones or bricks ornamenting the outside corner of a building.
Rafter.	Part of the frame for a wooden roof, sloping down from the ridge and establishing the pitch.
Return.	To carry a moulding around a corner; the moulding itself.
Ridge.	The peak of a roof; the point of meeting of the upper slopes of a roof.
Riser.	The vertical part of a step.
Sash.	A window frame that opens by sliding up or down.
Shed.	A lean-to roof; also the room created by the lean-to.
Sill	The heavy timber on the foundation of a building. Also the bottom crosspiece of a window frame.

String course.	A projecting course of bricks or some other material forming a narrow horizontal strip across the wall of a building.
Stud.	The upright post forming part of the framework of a braced-frame building.
Tenon.	A short projection from the end of a beam, pinned into a mortise.
Transom.	Horizontal glazed area above an aperture.
Turret.	A small, slender tower.
Tuscan Order.	A classical order noted for its simplicity; unfluted columns, unadorned capitals and plain entablatures.
Vault.	An arched covering in stone or brick over any building.
Veranda	A space alongside a house sheltered by a roof supported by columns, arches, etc.
Wainscot.	A facing or paneling, usually of wood, applied to the walls of a room, usually the lower part.
Water Table.	A projecting ledge, molding, or string course along the side of a building, designed to throw off rainwater.
Weatherboarding	Siding consisting of overlapping narrow boards usually thicker at one edge than the other.
Winders.	Steps with radiating risers and thus narrowing treads.

CHAPTER NINE

PICTORIAL GLOSSARY

FLOOR PLANS

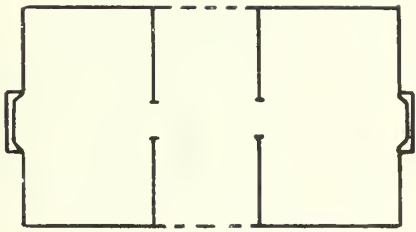

Dog Trot Cabin

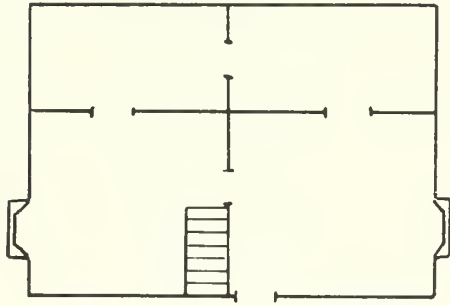

Plain Type

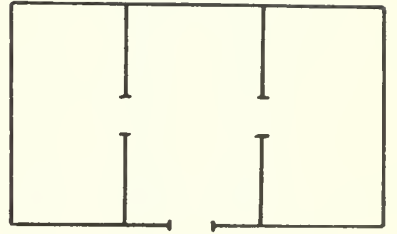

Two Room,
Central Hall

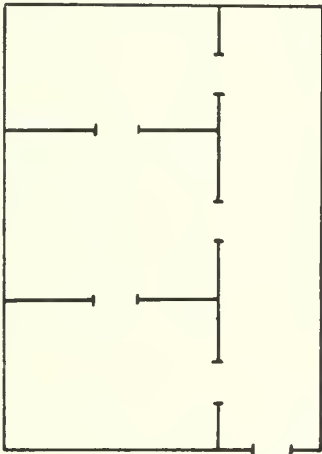

Side Hall

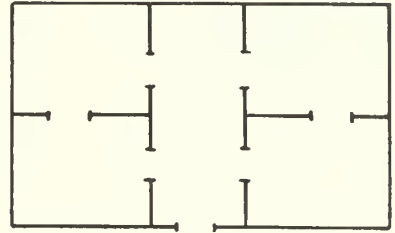

Four Room, Central Hall

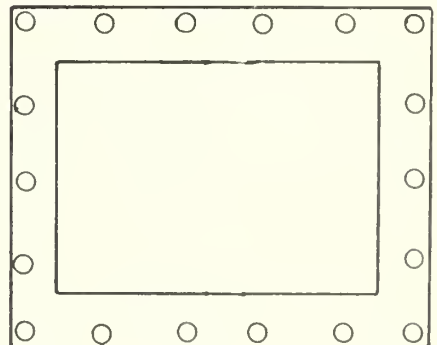
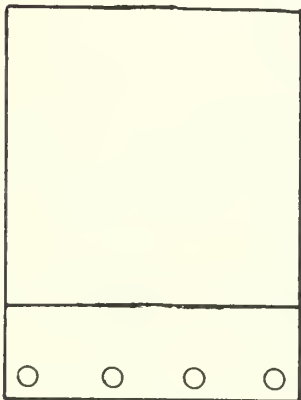

Temple Forms

May have colonnade on one or more sides of block form

DOORS

(Treatment illustrated here may also be found on windows.)

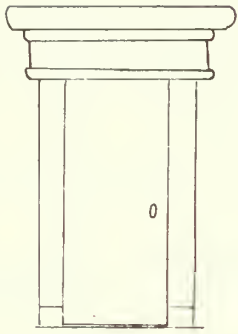

Entablature with Pilaster

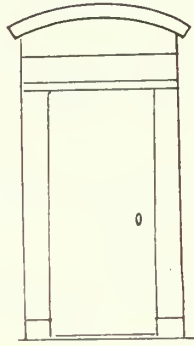

Segmental Pilaster with Pediment

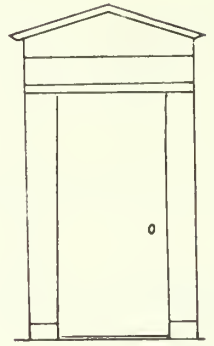

Plain Pediment with Pilaster

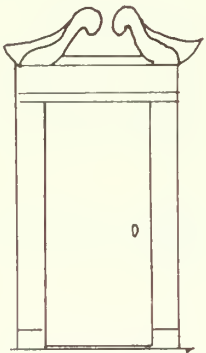

Swan's Neck Pediment with Pilaster

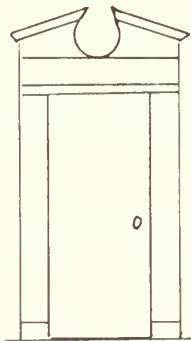

Broken Pediment with Pilaster

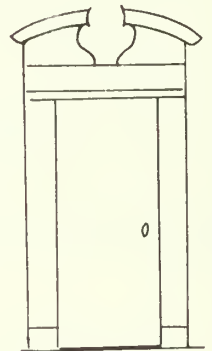

Broken Segmental Pediment with Pilaster

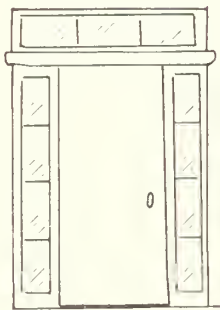

Trabeated: Transom and Sidelights

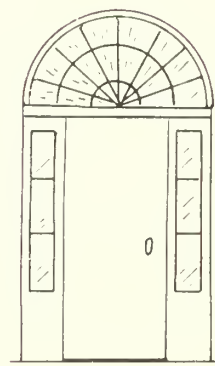

Fanlight (Semi-Circular or Elliptical) with Sidelights

WINDOWS

(Treatment illustrated here may also be found on doors.)

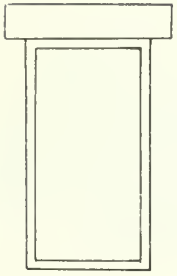

Lintel or Square Flat Arch
in Stone or Plaster

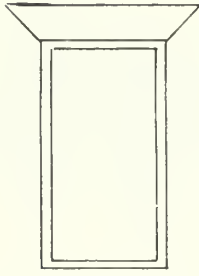

Lintel: Georgia
Variation

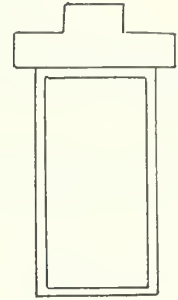

Lintel: Georgia
Variation

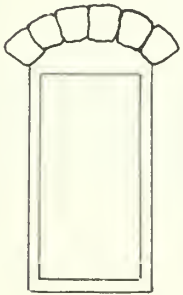

Segmental Arch with
Radiating Voussoirs (Flat
Guage Arch)

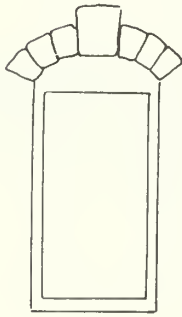

Segmental Arch with
Radiating Voussoirs and
Keystone

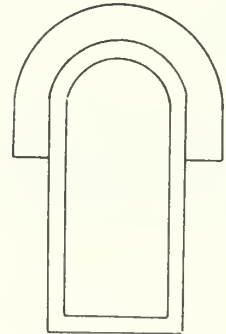

Italianate Arch



Lancet

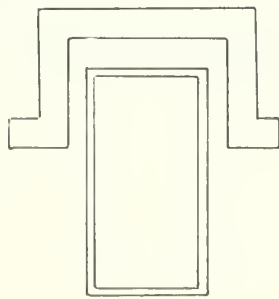

Dripstone Molding

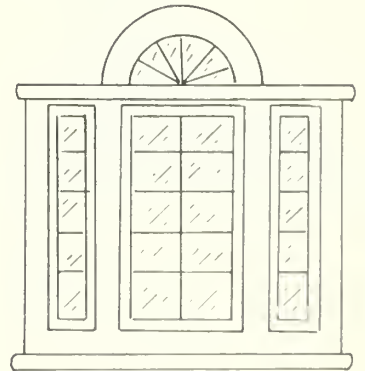

Palladian

ROOF TYPES

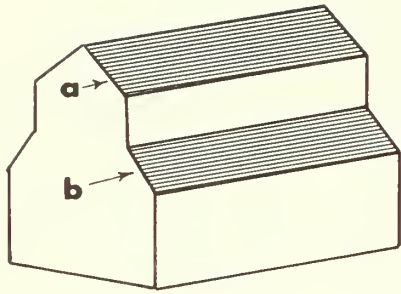

a. Pitched or Gable
b. Shed

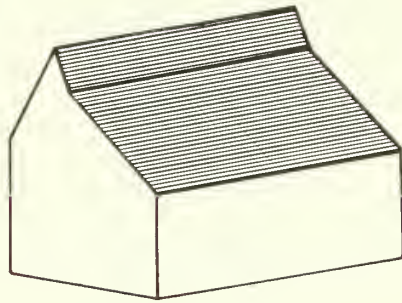

Modified Pitched Roof
Found in Georgia

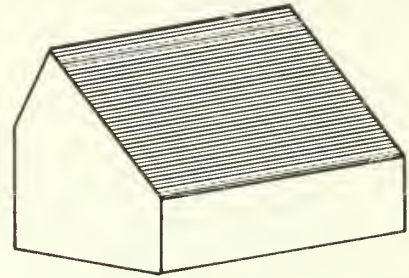

Saltbox

(This combination found in plantation plain type structures)

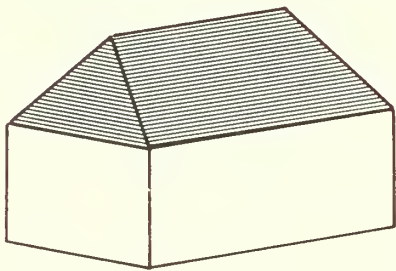

Hip

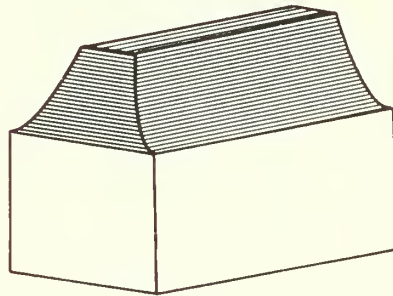

Mansard

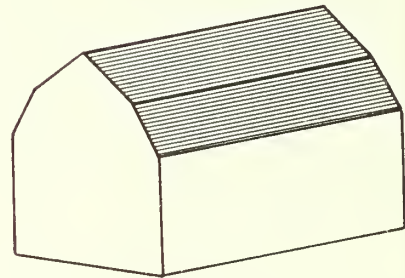

Gambrel

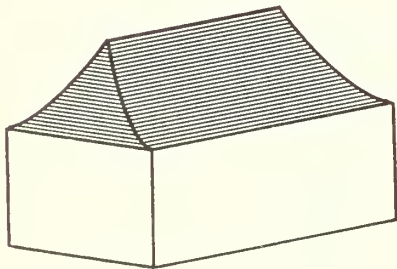

Bellcast Hip

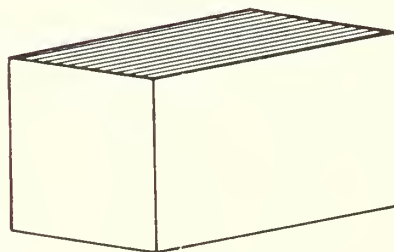

Flat (usually found in
commercial structures)

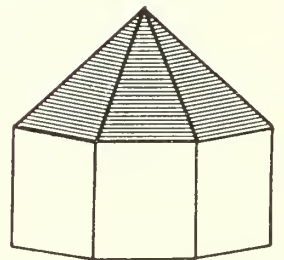

Conical

ROOF TRIMS

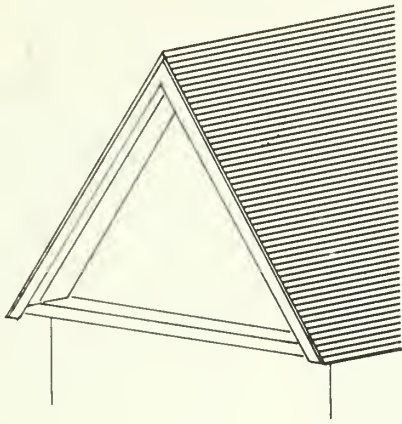

Pedimented Gable

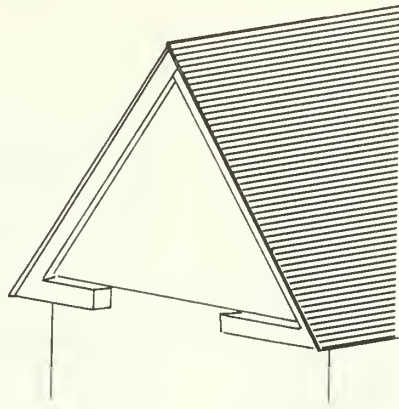

Gable with Boxed Cornice and Returns

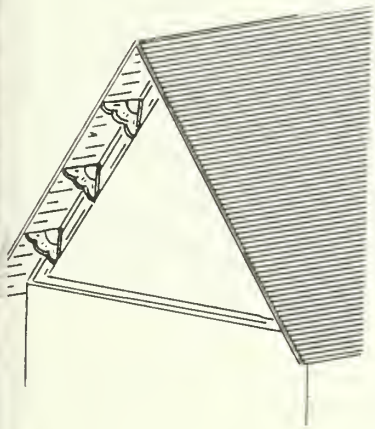

Gable with Brackets

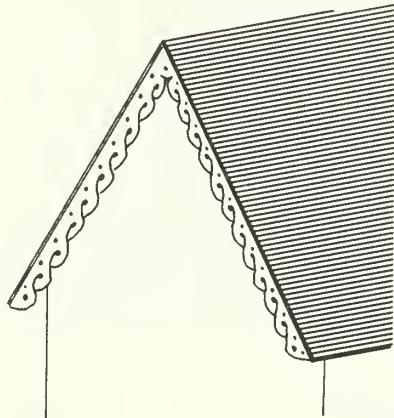

Bargeboard

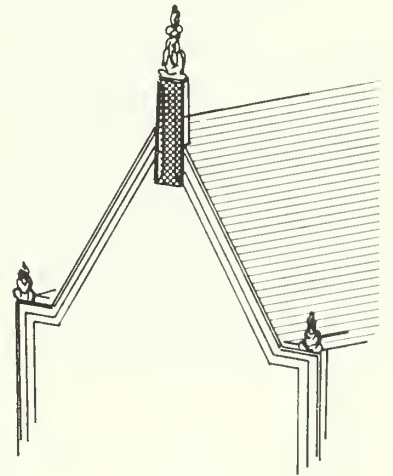

Decorated Gable

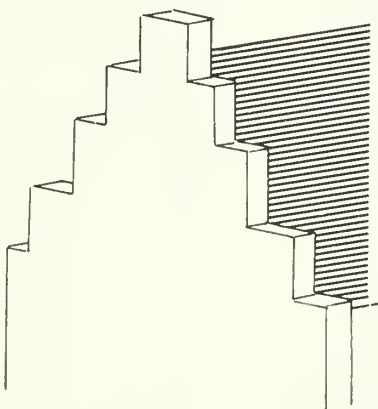

Stepped Gable

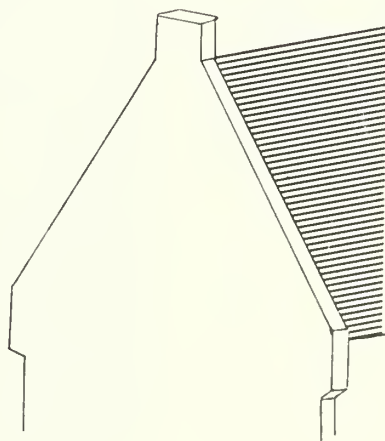

Parapet Gable

PORCHES

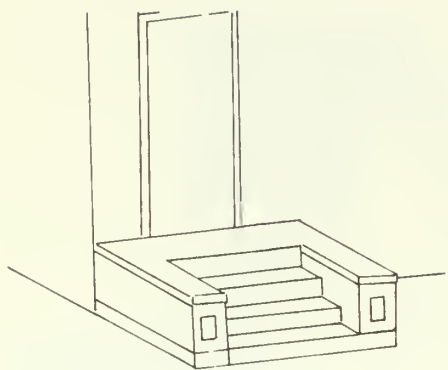

Stoop

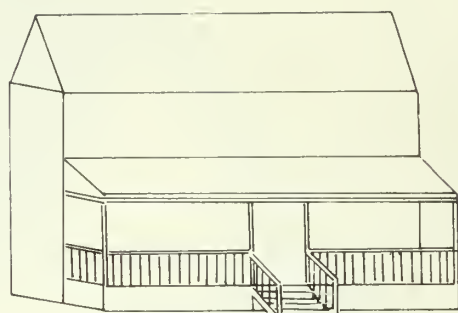

Shed Porch

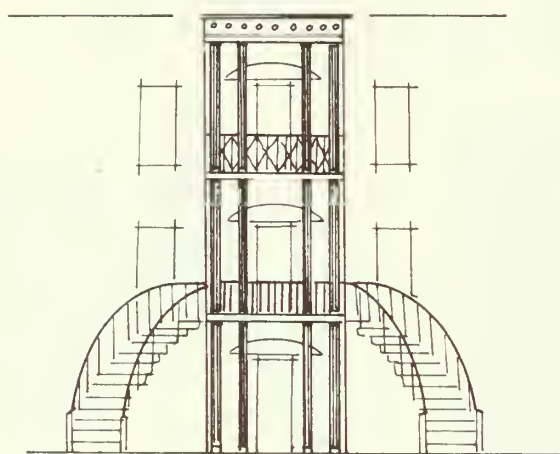

Central Triple (or Double) Portico
(Separate Columns for Each Floor Level)

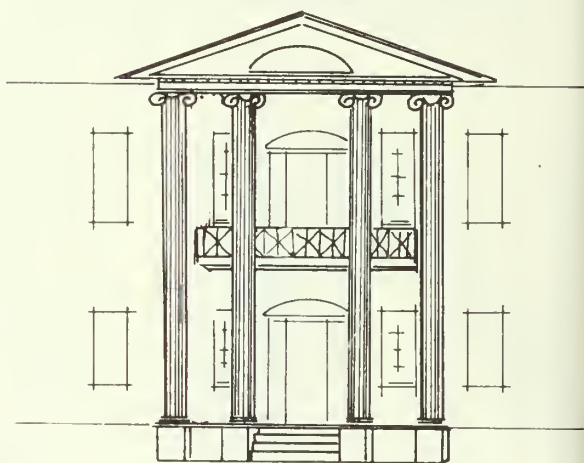

Central Two Story Portico (Continu
Columns Spanning Two Stories)

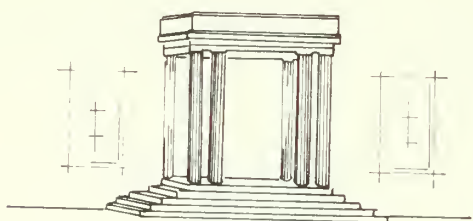

Central One Story Portico

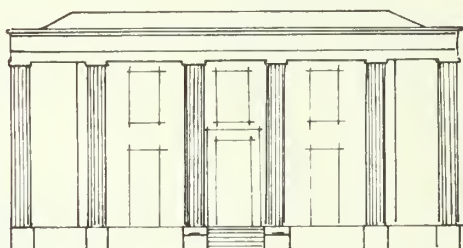

Full-Width Two Story Portico

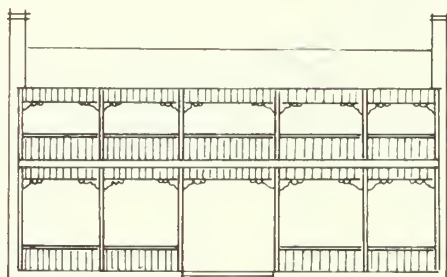

Double Veranda with Gingerbread Trim

COLUMNS

TUSCAN ORDER

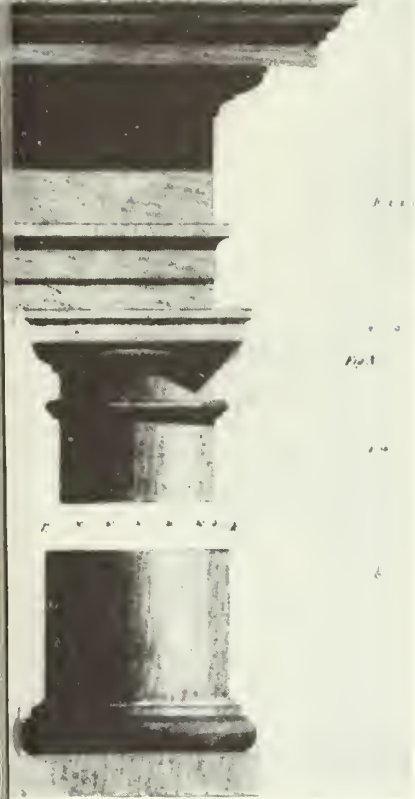

DORIC ORDER



IONIC ORDER



Composite Capital

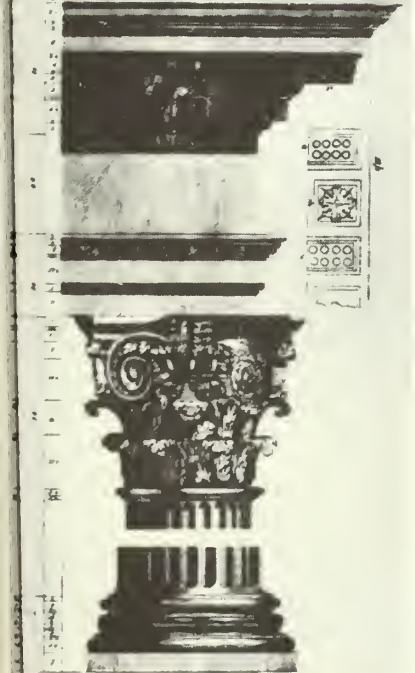

CORINTHIAN ORDER



Georgia Version of Ionic Column

MANTELPieces

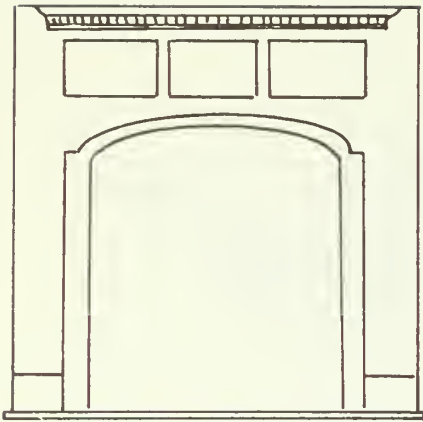

Early 19th Century
Distinguished by Rounded Opening

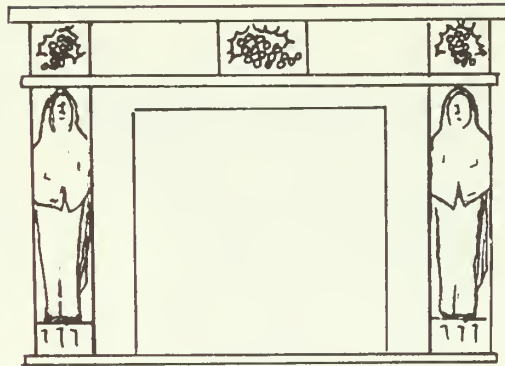

Regency

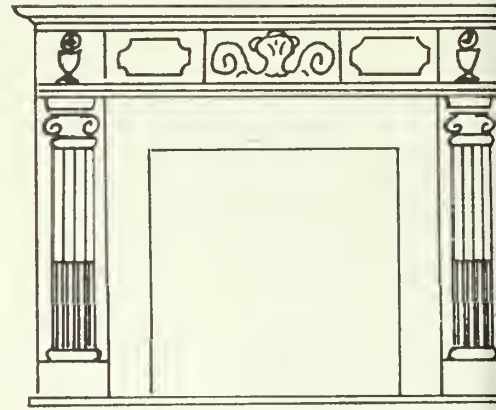

Federal

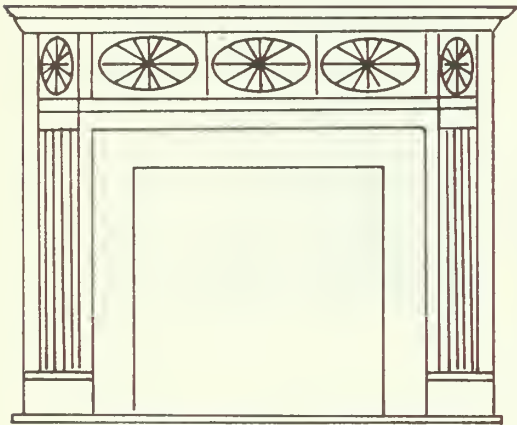

Federal with Sunburst
Variation

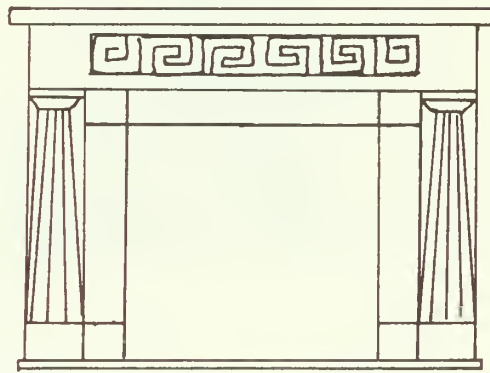

Greek Revival

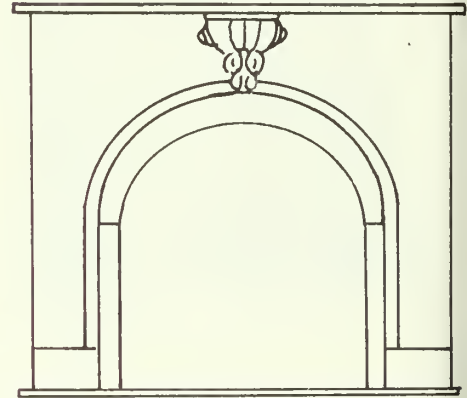

Greek Revival with
Rounded Opening

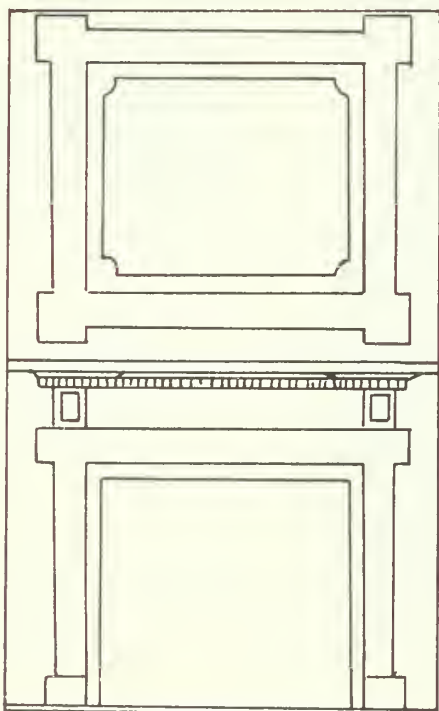

Mantelpiece with
Paneled, Over-Mantel Design

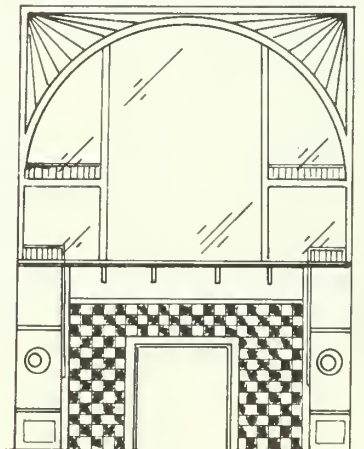

Victorian: Note Tilework
and Mirrors with Variety of
Shelves and Ornaments

STAIRS: DETAILS AND PLANS

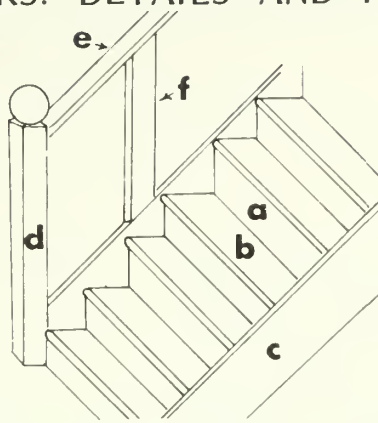

a. Riser
b. Tread
c. String
d. Newel
e. Handrail
f. Baluster

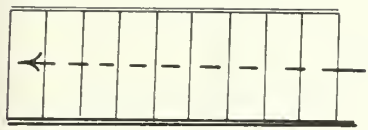

Straight

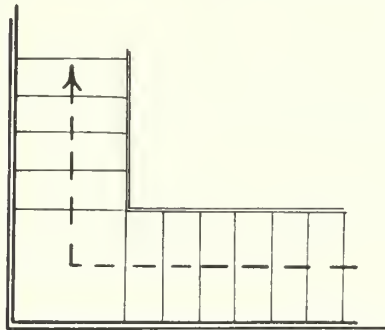

Quarter-turn with Landing

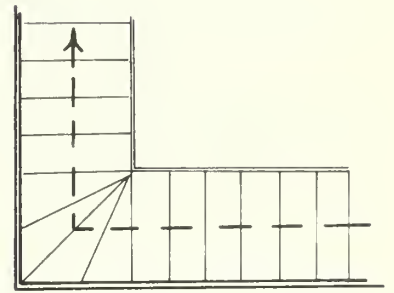

Quarter-Turn with Winders

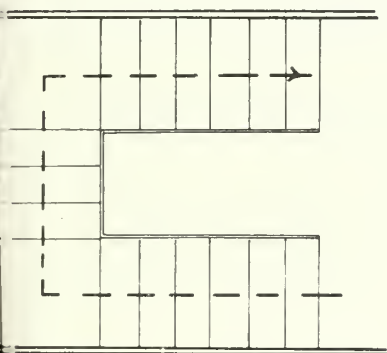

Half-Turn with Landings

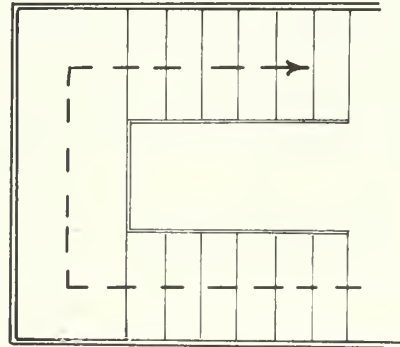

Dog-Leg Variation

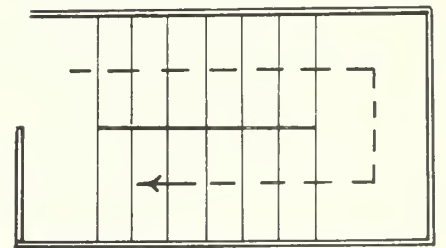

Dog-Leg

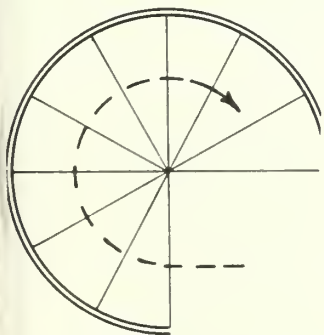

Circular Spiral

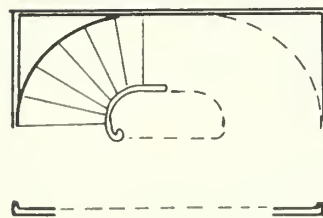

Oval Spiral

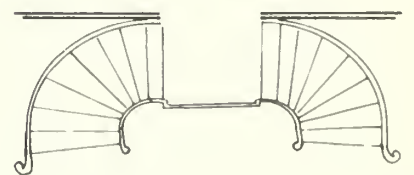

Double Curve with Landing

BRICK BONDING PATTERNS

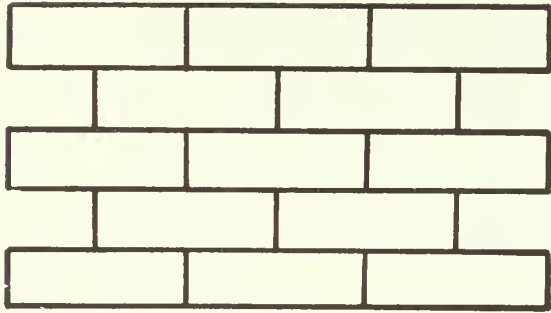

Stretcher Bond

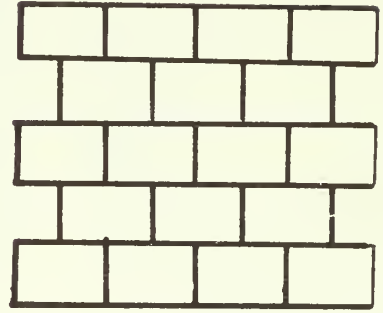

Header Bond

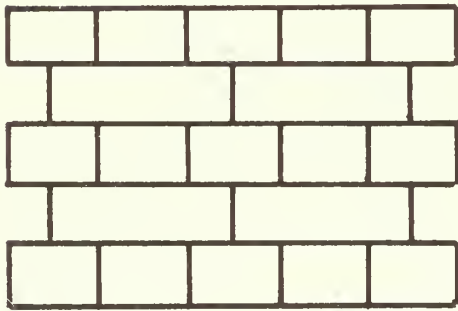

English Bond

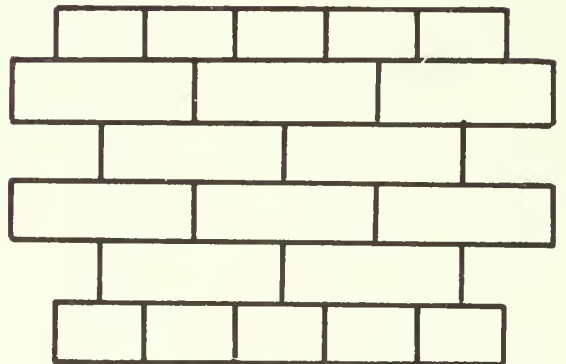

Common or American Bond

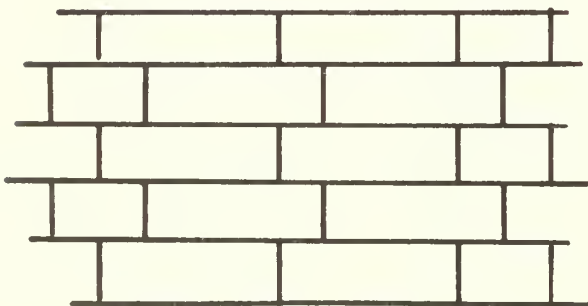

Garden Wall

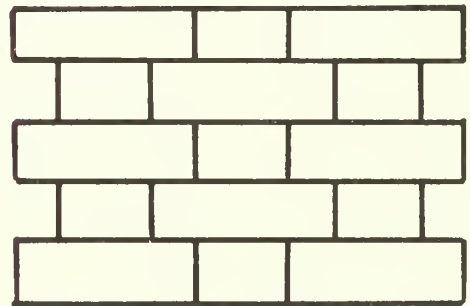

Flemish Bond

CHAPTER TEN

PUBLICATIONS

II. ARCHEOLOGY

Cotter, John L., HANDBOOK FOR HISTORICAL ARCHAEOLOGY, PART I. (published by the author, 8125 Heacock Lane, Wyncote, Pennsylvania 19095, 1968).

Deetz, James, INVITATION TO ARCHEOLOGY. (Garden City: Natural History Press, 1964).

Hole, Frank and Robert Heizer, AN INTRODUCTION TO PREHISTORIC ARCHEOLOGY. (New York: Holt, Reinhart and Winston, 1969).

Hume, Ivor Noel, ARCHAEOLOGY AND WETHERBURN'S TAVERN. (Williamsburg: Colonial Williamsburg, 1969).

Hume, Ivor Noel, A GUIDE TO ARTIFACTS OF COLONIAL AMERICA. (New York: Alfred A. Knopf, 1969).

Hume, Ivor Noel, HERE LIES VIRGINIA: AN ARCHAEOLOGIST'S VIEW OF COLONIAL LIFE AND HISTORY. (New York: Alfred A. Knopf, 1963).

Hume, Ivor Noel, HISTORICAL ARCHAEOLOGY. (New York: Alfred A. Knopf, 1969).

McGimsey, Charles R., III., PUBLIC ARCHAEOLOGY. (New York: Seminar Press, 1972).

Stuart, George, DISCOVERING MAN'S PAST IN THE AMERICAS. (Washington, D.C.: National Geographic Society, 1969)

Woodall, J. Ned, AN INTRODUCTION TO MODERN ARCHEOLOGY. (Cambridge: Schenkman Publishing Company, 1972).

ARCHITECTURE

A. REFERENCE

1. REFERENCE AIDS

Fletcher, Banister, A HISTORY OF ARCHITECTURE ON THE COMPARATIVE METHOD. (New York: Charles Scribner's Sons, 1967, originally published 1896).

Fleming, John, Hugh Honour and Nikolaus Pevsner, THE PENGUIN DICTIONARY OF ARCHITECTURE. (Baltimore: Penguin Books, 1967).

Goeldner, Paul, compiler, A BRIEF BIBLIOGRAPHY FOR THE RESTORATION OF HISTORIC BUILDINGS. (Washington: National Park Service, 1971).

Whiffen, Marcus, AMERICAN ARCHITECTURE SINCE 1780: A GUIDE TO THE STYLES. (Cambridge: M.I.T. Press, 1969).

Whitehill, Walter Muir, THE ARTS IN EARLY AMERICAN HISTORY. (Chapel Hill: University of North Carolina Press, 1965).

2. GENERAL HISTORIES

Coleman, Kenneth, GEORGIA HISTORY IN OUTLINE. (Athens: University of Georgia Press, 1960).

Coulter, E. Merton, GEORGIA: A SHORT HISTORY. (Chapel Hill: University of North Carolina Press, 1947).

Reese, Trevor, THE MOST DELIGHTFUL COUNTRY OF THE UNIVERSE: PROMOTIONAL LITERATURE OF THE COLONY OF GEORGIA, 1717-34. (Savannah: Beehive Press, 1972).

3. LOCAL HISTORIES

Cate, Margaret Davis, EARLY DAYS OF COASTAL GEORGIA. (St. Simons: Fort Frederica Association, 1955).

—————, County Histories. (Many Georgia counties are represented in individual county histories).

Lane, Mills B., IV, SAVANNAH REVISITED: A PICTORIAL HISTORY. (Athens: University of Georgia Press, 1969).

4. PERSONAL DESCRIPTIONS AND "COLLECTIONS"

Brown, John, SLAVE LIFE IN GEORGIA. (Savannah: Beehive Press, 1972, reprint of 1855 publication).

DeVorse, Louis, ed., DEBRAHM'S REPORT OF THE GENERAL SURVEY IN THE SOUTHERN DISTRICT OF NORTH AMERICA. (Columbia: University of South Carolina Press, 1971).

Hall, Basil, FORTY ETCHINGS, FROM SKETCHES MADE WITH THE CAMERA LUCIDA, IN NORTH AMERICA, IN 1827 AND 1828. (Edinburgh: Cadell and Company; London: Simpson and Marshall, and Moon, Boys, and Braves, 1830).

Lane, Mills B., IV, *THE RAMBLER IN GEORGIA*. (Savannah: Beehive Press, 1973).

Milfort, Louis LeClerc, *MY SOJOURN IN THE CREEK NATION*. (Savannah: Beehive Press, 1972, reprint).

Sherwood, Adiel, *A GAZETTEER OF THE STATE OF GEORGIA*. (Athens: University of Georgia Press, 1939, reprint of 1827 publication).

Trowbridge, J. T., *THE SOUTH: A TOUR OF ITS BATTLE-FIELDS AND RUINED CITIES*. (Hartford: L. Stebbins, 1866).

Van Doren, Mark, ed., *TRAVELS OF WILLIAM BARTRAM*. (New York: Dover Publications, 1928, original copyright 1791).

White, George, *HISTORICAL COLLECTIONS OF GEORGIA*. (New York: Pudney and Russell, 1854).

White, George, *STATISTICS OF THE STATE OF GEORGIA*. (Savannah: W. Thorne Williams, 1849).

· BIOGRAPHIES OF ARCHITECTS

Gallagher, H. M. Pierce, *ROBERT MILLS, ARCHITECT OF THE WASHINGTON MONUMENT, 1781-1855*. (New York: n. pub., 1935).

Gilchrist, Agnes Addison, *WILLIAM STRICKLAND, ARCHITECT AND ENGINEER, 1788-1854*. (Philadelphia: University of Pennsylvania Press, 1950).

Guiness, Desmond and Julius Trousdale Sadler, Jr., *MR. JEFFERSON, ARCHITECT*. (New York: Viking Press, 1973).

Hamlin, Talbot, *BENJAMIN HENRY LATROBE*. (New York: n. pub., 1955).

Hobhouse, Hermione, *THOMAS CUBITT, MASTER BUILDER*. (New York: Universe Books, 1971).

Kimball, Fiske, *THOMAS JEFFERSON, ARCHITECT*. (New York: DaCapo Press, 1968, reprint of 1916 publication).

Kirker, Harold, *THE ARCHITECTURE OF CHARLES BULFINCH*. (Cambridge: Harvard Press, 1969).

McDonough, James Vernon, *WILLIAM JAY, REGENCY ARCHITECT IN GEORGIA AND SOUTH CAROLINA*. (Ann Arbor: University of Michigan Microfilm, 1970).

Monroe, Harriet, JOHN WELLBORN ROOT. (Park Forest, Illinois: Prairie School Press, 1966).

Nichols, Frederick Doveton, THOMAS JEFFERSON'S ARCHITECTURAL DRAWINGS. (Boston: Massachusetts Historical Society, 1961).

Revenal, Beatrice St. Julien, ARCHITECTS OF CHARLESTON. (Charleston: Carolina Art Association, 1964).

Thompson, Paul, WILLIAM BUTTERFIELD, VICTORIAN ARCHITECT. (Cambridge: M.I.T. Press, 1971).

Upjohn, Edward M., RICHARD UPJOHN, ARCHITECT AND CHURCHMAN. (New York: DaCapo Press, 1968).

Van Renselaer, Mariana Griswold, HENRY HOBSON RICHARDSON AND HIS WORKS. (New York: Dover Publications, Inc. 1969).

Withey, Henry F. and Elsie Rathburn Withey, BIOGRAPHICAL DICTIONARY OF AMERICAN ARCHITECTS (DECEASED). (Los Angeles: Hennessey and Ingalls, Inc., 1956).

C. ARCHITECTS' OR BUILDERS' HANDBOOKS OF THE PERIOD

Benjamin, Asher, THE AMERICAN BUILDER'S COMPANION. (New York: Dover Publications, Inc., 1969, reprint of 1827 edition).

Benjamin, Asher, THE PRACTICAL HOUSE CARPENTER. (New York: J.P. Peaslee, 1835, original edition).

Benjamin, Asher, PRACTICE OF ARCHITECTURE. (New York: DaCapo Press, 1972, reprint of 1833 publication).

Downing, A. J., THE ARCHITECTURE OF COUNTRY HOUSES. (New York: Dover Publications, Inc., 1969, reprint of 1850 edition).

Downing, A. J., Cottage Residences, RURAL ARCHITECTURE AND LANDSCAPE GARDENING. (n. p.: Library of Victorian Culture, 1967, first published in 1842).

Gibbs, James, A BOOK OF ARCHITECTURE. (New York: Benjamin Blom, Inc., 1968, reprint of 1728 publication).

Halfpenny, William, THE ART OF SOUND BUILDING. (New York: Benjamin Blom, Inc., 1968, reprint of 1725 publication).

Halfpenny, William, PRACTICAL ARCHITECTURE. (New York: Benjamin Blom, Inc., 1968, reprint of 1730 publication).

Lafever, Minard, THE BEAUTIES OF MODERN ARCHITECTURE. (New York: DaCapo Press, 1968, reprint of 1835 edition).

Lafever, Minard, THE MODERN BUILDER'S GUIDE. (New York: Dover Publications, Inc., 1969, reprint of 1833 edition).

Langley, Batty, THE CITY AND COUNTRY BUILDER'S AND WORKMAN'S TREASURY OF DESIGNS. (New York: Benjamin Blom, Inc., 1967, reprint of 1750 publication).

Langley, Batty and Thomas, THE BUILDER'S JEWEL. (New York: Benjamin Blom, Inc., 1970, reprint of 1746 publication).

Peterson, Charles E., CARPENTERS' COMPANY OF THE CITY AND COUNTY OF PHILADELPHIA 1786 RULE BOOK. (Princeton: Pyne Press, 1971).

Vaux, Calvert, VILLAS AND COTTAGES. (New York: DaCapo Press, 1968, reprint of 1857 edition).

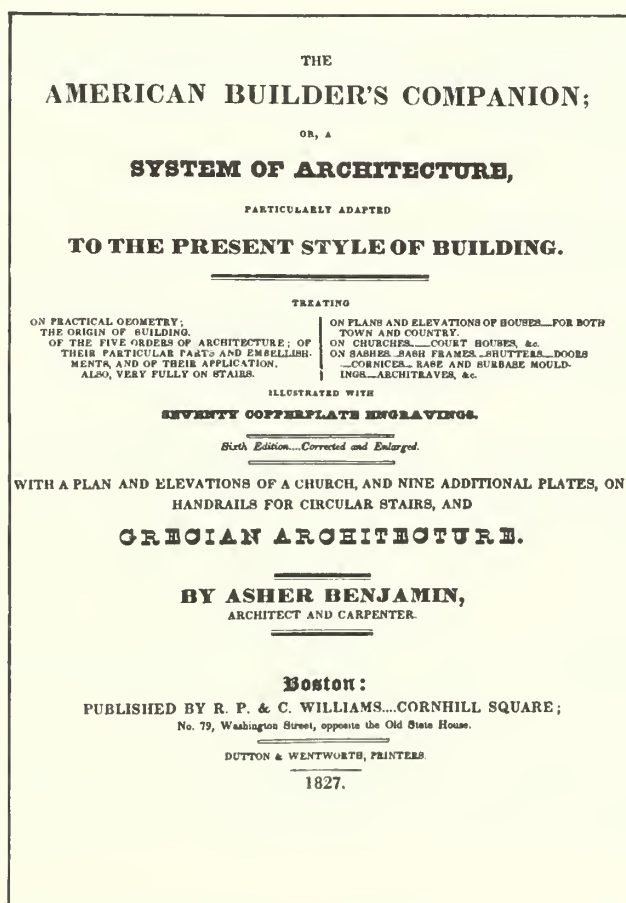

D. GUIDES TO CRAFTS AND TRADES

Hummel, Charles F. WITH HAMMER IN HAND: THE DOMINY CRAFTSMEN OF EAST HAMPTON, NEW YORK. (Charlottesville: University of Virginia Press, 1968).

Shannon, J. B., ILLUSTRATED CATALOGUE AND PRICE LIST OF CARPENTERS' TOOLS. (Philadelphia: McCalla and Stavely, 1873, reprint).

Welsh, Peter C., WOODWORKING TOOLS, 1600-1900. (Washington: Smithsonian Institution, 1966).

Wildung, Frank H., WOODWORKING TOOLS AT SHELBURNE MUSEUM. (Selburne, Vermont: Selburne Museum, 1957).

E. ARCHITECTURE, GENERAL WORKS

Architects' Emergency Committee, GREAT GEORGIAN HOUSES OF AMERICA, 2 vols. (New York: Dover Publications, 1970).

Brown, Sheldon S., REMADE IN AMERICA. (Salem, Oregon: Old Time Bottle Publishing Company, 1972).

Condit, Carl W., AMERICAN BUILDING: MATERIALS AND TECHNIQUES FROM THE FIRST COLONIAL SETTLEMENTS TO THE PRESENT. (Chicago: University of Chicago Press, 1968).

Denmark, Ernest Ray, ARCHITECTURE OF THE OLD SOUTH. (Atlanta: Southern Architect and Building News, 1926).

Earl, Alice Morse, STAGE-COACH AND TAVERN DAYS. (New York: Dover Publications, 1969).

Forman, Henry Chandler, THE ARCHITECTURE OF THE OLD SOUTH. (Cambridge: Harvard University Press, 1948).

Franzen, Marilyn D., CAPITOL CAPSULES. (New York: Bonanza Books, n.d.).

Gillon, Edmund V., Jr., EARLY ILLUSTRATIONS AND VIEWS OF AMERICAN ARCHITECTURE. (New York: Dover Publications, 1971).

Glassie, Henry, PATTERN IN THE MATERIAL FOLK CULTURE OF THE EASTERN UNITED STATES. (Philadelphia: University of Pennsylvania Press, 1968).

Greiff Constance M., ed., LOST AMERICA: FROM THE ATLANTIC TO THE MISSISSIPPI. (Princeton: Pyne Press, 1971).

Hamlin, Talbot, GREEK REVIVAL ARCHITECTURE IN AMERICA. (New York: Dover Publications, Inc., 1964).

Hansen, Hans Jurgen, ARCHITECTURE IN WOOD: A HISTORY OF WOOD BUILDING AND ITS TECHNIQUES IN EUROPE AND NORTH AMERICA. (New York: Viking Press, 1971).

Hersey, George L., HIGH VICTORIAN GOTHIC. (Baltimore: Johns Hopkins University Press, 1972).

Holland, Francis Ross, Jr., AMERICA'S LIGHTHOUSES (Brattleboro, Vermont: Stephen Greene Press, 1972).

Howells, John Mead, LOST EXAMPLES OF COLONIAL ARCHITECTURE. (New York: Dover Publications, Inc., 1963).

Isham, Norman Morrison, EARLY AMERICAN HOUSES AND A GLOSSARY OF COLONIAL ARCHITECTURAL TERMS. (New York: DaCapo Press, 1967).

Kaufmann, Edgar, Jr., ed., THE RISE OF AN AMERICAN ARCHITECTURE. (New York: Praeger Publishers, 1970).

Kauffman, Henry J., THE AMERICAN FIREPLACE: CHIMNEYS, MANTELPIECES, FIREPLACES AND ACCESSORIES. (Nashville: Thomas Nelson, Inc., 1972).

Kimball, Fiske, DOMESTIC ARCHITECTURE OF THE AMERICAN COLONIES AND OF THE EARLY REPUBLIC. (New York: Dover Publications, Inc., 1966).

Lancaster, Clay, ARCHITECTURAL FOLLIES IN AMERICA. (Rutland, Vermont: Charles E. Tuttle Company, 1960).

Maass, John, THE GINGERBREAD AGE: A VIEW OF VICTORIAN AMERICA. (New York: Bramhall House, 1965).

Menten, Theodore, THE ART DECO STYLE. (New York: Dover Publications, 1972).

Mercer, Henry C., THE DATING OF OLD HOUSES. (Doylestown, Pennsylvania: Bucks County Historical Society, 1923).

Morrison, Hugh, EARLY AMERICAN ARCHITECTURE FROM THE FIRST COLONIAL SETTLEMENTS TO THE NATIONAL PERIOD. (New York: Oxford University Press, 1952).

Mumford, Lewis, THE SOUTH IN ARCHITECTURE. (New York: DaCapo Press, 1967).

Pierson, William H., Jr., AMERICAN BUILDINGS AND THEIR ARCHITECTS. (Garden City: Doubleday & Company, Inc., 1970).

Pillsbury, Richard and Andrew Kardos, A FIELD GUIDE TO THE FOLK ARCHITECTURE OF THE NORTHEASTERN UNITED STATES (Hanover, New Hampshire: Department of Geography, Dartmouth College, n.d.)

Scully, Vincent, THE SHINGLE STYLE. (New Haven: Yale University Press, c.1952).

Shurtleff, Harold R., THE LOG CABIN MYTH. (Gloucester, Massachusetts: Peter Smith, 1967).

Sloane, Eric, AN AGE OF BARNES. (New York: Funk & Wagnall, n.d.)

Sloane, Eric, AMERICAN BARNES AND COVERED BRIDGES. (New York: Funk and Wagnall, 1954).

Society of Architectural Historians, ABSTRACTS OF PAPERS PRESENTED AT THE SAH ANNUAL MEETINGS, 1968, 1969, 1971.

Stanton, Phoebe B., THE GOTHIC REVIVAL AND AMERICAN CHURCH ARCHITECTURE. (Baltimore: Johns Hopkins University Press, 1968).

Sturges, W. Knight, THE ORIGINS OF CAST IRON ARCHITECTURE IN AMERICA. (New York: DaCapo Press, 1970, reprint of 1856 publication).

Summerson, John, THE CLASSICAL LANGUAGE OF ARCHITECTURE. (Cambridge: MIT Press, 1963).

Whiffen, Marcus, AMERICAN ARCHITECTURE SINCE 1780: A GUIDE TO THE STYLES. (Cambridge: M.I.T. Press, 1969).

Williams, Henry L. and Ottalee K., A GUIDE TO OLD AMERICAN HOUSES, 1700-1900. (New York: A. S. Barnes & Company, Inc., 1962).

Wilson, Everett B., EARLY SOUTHERN TOWNS. (South Brunswick: A. S. Barnes & Co., 1967).

Yonder, Paton, TAVERNS AND TRAVELERS: INNS OF THE EARLY MIDWEST. (Bloomington, Indiana: Indiana University Press, 1969).

F. ARCHITECTURE, GEORGIA

Bonner, James C., A HISTORY OF GEORGIA AGRICULTURE, 1732-1860, Chapter XI, "Gardens and Buildings," (Athens: University of Georgia Press, 1964).

Bush-Brown, Harold, *OUTLINE OF THE DEVELOPMENT OF EARLY AMERICAN ARCHITECTURE; THE SOUTHERN STATES; DISTRICT-GEORGIA*. (Washington: H.A.B.S., 1936).

Cannon, Margaret, *SOUTHWEST GEORGIA HOMES OF GREEK REVIVAL INFLUENCE AND THEIR FURNITURE, 1820-1890*. (Tallahassee: Florida State University, 1963).

Clarke, E. Y., *ILLUSTRATED HISTORY OF ATLANTA, 1879*. (Atlanta: Cherokee Publishing Company, 1971, reprint of original publication).

Cooney, Loraine M., *GARDEN HISTORY OF GEORGIA, 1733-1933*. (Atlanta: Peachtree Garden Club, 1933).

Corry, John P., "The Houses of Colonial Georgia," *GEORGIA HISTORICAL QUARTERLY*. Vol. XIV, No. 3, (September 1930).

Davidson, William H., *BROOKS OF HONEY AND BUTTER: PLANTATIONS AND PEOPLE OF MERIWETHER COUNTY*. (Alexander City, Alabama: Outlook Publishing Company, 1971).

Davidson, William H., *PINE LOG AND GREEK REVIVAL, HOUSES AND PEOPLE OF THREE COUNTIES IN GEORGIA AND ALABAMA*. (Alexander City, Alabama: Outlook Publishing Company, 1964).

Davis, William Columbus, *THE COLUMNS OF ATHENS: GEORGIA'S CLASSIC CITY*. (Atlanta: Foote and Davies, Inc., 1951).

Howard, Annie Hornady, ed., *GEORGIA HOMES AND LANDMARKS*. (Atlanta: Southern Features Syndicate, 1929).

Kapetanakos, Stephanie A., *ARCHITECTURE OF NEEL REID*, (Masters Thesis, University of Georgia, 1971).

Linley, John, *ARCHITECTURE OF MIDDLE GEORGIA: THE OCONEE AREA*. (Athens: University of Georgia Press, 1972).

March, Kenneth F. and Blanche, *ATHENS: GEORGIA'S COLUMNED CITY*. (Ashville, North Carolina: Biltmore Press, 1964).

Nichols, Frederick Doveton, *THE EARLY ARCHITECTURE OF GEORGIA*. (Chapel Hill: University of North Carolina Press, 1957).

Perkerson, Medora Field, *WHITE COLUMNS IN GEORGIA*. (New York: Rinehart and Co., 1952).

Richards, William C., ed., *GEORGIA ILLUSTRATED IN A SERIES OF VIEWS, EMBRACING NATURAL SCENERY AND PUBLIC EDIFICES*,

ENGRAVED ON STEEL. . . FROM SKETCHES MADE. . . BY T. ADDISON RICHARDS. (Penfield, Georgia: W. and W.C. Richards, 1842), copy available at University of Georgia Library.

Rodgers, Ava D., THE HOUSING OF OGLETHORPE COUNTY, GEORGIA, 1790-1860. (Tallahassee: Florida State University Press, 1971).

Zelinsky, Wilbur, "The Greek Revival House in Georgia," SOCIETY OF ARCHITECTURAL HISTORIANS, (May 1954).

G. ARCHITECTURE, OTHER STATES

Acworth, Angus Whiteford, BUILDINGS OF ARCHITECTURAL OR HISTORIC INTEREST IN THE BRITISH WEST INDIES. (London: Colonial Research Studies No. 2, 1951).

Alderson, William T. and Robert M. McBride, ed., LANDMARKS OF TENNESSEE HISTORY. (Nashville: Tennessee Historical Commission and Tennessee Historical Society, 1965).

Bracken, Dorothy Kendall and Maurine Whorton Redway, EARLY TEXAS HOMES. (Dallas: Southern Methodist University Press, 1956).

Campen, Richard N., ARCHITECTURE OF THE WESTERN RESERVE, 1800-1900. (Cleveland, Ohio: Press of Case Western Reserve University, 1971).

Coffin, Lewis A., Jr. and Arthur C. Holden, BRICK ARCHITECTURE OF THE COLONIAL PERIOD IN MARYLAND AND VIRGINIA. (New York: Dover Publications, 1970, reprint of 1919 publication).

Cummings, Abbott Lowell, ARCHITECTURE IN EARLY NEW ENGLAND. (Sturbridge, Mass.: Old Sturbridge Village, 1958).

Curtis, Elizabeth G., GATEWAYS AND DOORWAYS OF CHARLESTON, SOUTH CAROLINA, IN THE 18TH AND 19TH CENTURIES. (New York: Bonanza Books, 1926).

Downing, Antoinette F. and Vincent J. Sculley, Jr., THE ARCHITECTURAL HERITAGE OF NEWPORT, RHODE ISLAND, 1640-1915. (New York: Clarkston N. Potter, Inc., 1967).

Frary, I. T., EARLY HOMES OF OHIO. (New York: Dover Publications, Inc., 1970).

Isham, Norman M. and Albert F. Brown, EARLY CONNECTICUT HOUSES: AN HISTORICAL AND ARCHITECTURAL STUDY. (New York: Dover Publications, Inc., 1965).

Johnston, Frances Benjamin and Thomas Tileston Waterman, THE EARLY ARCHITECTURE OF NORTH CAROLINA. (Chapel Hill: University of North Carolina Press, 1947).

Lancaster, Clay, "Greek Revival Architecture in Alabama," ALABAMA ARCHITECT. (January-February 1968).

McBride, Robert M., ed., MORE LANDMARKS OF TENNESSEE HISTORY. (Nashville: Tennessee Historical Commission and Tennessee Historical Society, 1969).

O'Neal, William B., ARCHITECTURAL DRAWING IN VIRGINIA, 1819-1969. (Charlottesville: School of Architecture of the University of Virginia, 1969).

Smith, J. Frazier, WHITE PILLARS, EARLY LIFE AND ARCHITECTURE OF THE LOWER MISSISSIPPI VALLEY COUNTRY. (New York: Bramhall House, 1941).

Stoney, Samuel Gaillard, PLANTATIONS OF THE CAROLINA LOW COUNTRY. (Charleston: Carolina Art Association, 1964).

Wallace, Philip B., COLONIAL IRONWORK IN OLD PHILADELPHIA. (New York: Dover Publications, 1970).

Waterman, Thomas Tileston, THE MANSIONS OF VIRGINIA, 1706-1776. (Chapel Hill: University of North Carolina Press, 1945).

Waterman, Thomas Tileston and John A. Barrows, DOMESTIC COLONIAL ARCHITECTURE OF TIDEWATER VIRGINIA. (New York: Dover Publications, Inc., 1969).

Whiffen, Marcus, THE EIGHTEENTH-CENTURY HOUSES OF WILLIAMSBURG. (Williamsburg: Colonial Williamsburg, 1958).

Whiffen, Marcus, THE PUBLIC BUILDINGS OF WILLIAMSBURG. (Williamsburg: Colonial Williamsburg, 1958).

Wodehouse, Lawrence, "Architecture in North Carolina, 1700-1900," NORTH CAROLINA ARCHITECT. (January-February 1970).

I. ARCHITECTURAL SURVEYS AND GUIDEBOOKS

Boston Society of Architects, BOSTON ARCHITECTURE. (Cambridge: MIT Press, 1970).

Dulaney, Paul S., THE ARCHITECTURE OF HISTORIC RICHMOND. (Charlottesville: University Press of Virginia, 1968).

Feiss, Carl, HISTORIC COLUMBUS BUILDING INVENTORY.

Feiss, Carl and Russell Wright, HISTORIC THOMASVILLE, AN INVENTORY OF HISTORIC BUILDINGS AND SITES PROGRAMS RECOMMENDATIONS TO THOMASVILLE LANDMARKS, November 1969.

—————, GEORGETOWN HISTORIC WATERFRONT: A REVIEW OF CANAL AND RIVERSIDE ARCHITECTURE. (Washington: U.S. Commission of Fine Arts and Office of Archeology and Historic Preservation, National Park Service, 1968).

—————, A GUIDE TO MACON'S ARCHITECTURAL AND HISTORICAL HERITAGE. (Macon: Middle Georgia Historical Society, 1972).

————— HISTORIC AMERICAN BUILDINGS SURVEY. (Washington: H.A.B.S., 1941).

————— HISTORIC SAVANNAH. (Savannah: Historic Savannah Foundation, Inc., 1968).

Lancaster, Clay, THE ARCHITECTURE OF HISTORIC NANTUCKET. (New York: McGraw-Hill Book Company, 1972).

Lockwood, Charles, BRICKS AND BROWNSTONE: THE NEW YORK ROW HOUSE. (New York: McGraw-Hill Book Company, 1972).

Massey, John C., "The Architectural Survey," PRESERVATION LEAFLET SERIES. (Washington: National Trust for Historic Preservation, 1969).

McCue, George, THE BUILDING ART IN ST. LOUIS. (St. Louis: St. Louis Chapter, AIA, 1967).

National Capital Planning Commission with District of Columbia Redevelopment Land Agency, DOWNTOWN URBAN RENEWAL AREA LANDMARKS, WASHINGTON, D. C. (Washington: U.S. Printing Office, 1970).

O'Neal, William B., ARCHITECTURE IN VIRGINIA. (New York: Walker & Co., 1968).

Providence City Plan Commission, COLLEGE HILL: A DEMONSTRATION STUDY OF HISTORIC AREA RENEWAL. (Providence: College Hill Press, 1967).

Reeves, F. Blair, "Heritage Trail, A Windshield Survey of Florida's Historic Architecture," THE FLORIDA ARCHITECT. (January-February 1970).

Reiff, Daniel D., WASHINGTON ARCHITECTURE, 1791-1861. (Washington: U.S. Commission of Fine Arts, 1971).

Rettig, Robert Bell, GUIDE TO CAMBRIDGE ARCHITECTURE, TEN WALKING TOURS. (Cambridge: M.I.T. Press, 1969).

Stoney, S. G., THIS IS CHARLESTON. (Charleston: Carolian Art Association, 1964).

Van Trump, James D. and Arthur P. Ziegler, Jr., LANDMARK ARCHITECTURE OF ALLEGHANY COUNTY, PENNSYLVANIA. (Pittsburg: Pittsburg History and Landmarks Foundation, 1967).

Washington Metropolitan Chapter, AIA, A GUIDE TO THE ARCHITECTURE OF WASHINGTON, D.C. (Washington: Frederick A. Praeger, 1965).

Webster, J. Carson, CHICAGO'S FAMOUS BUILDINGS. (Chicago: University of Chicago Press, 1965).

White, Norval and Elliot Willensky, ed., AIA GUIDE TO NEW YORK CITY. (London: Collier-Macmillan, Ltd., 1967).

III. PERIOD INTERIORS: DECORATIVE ARTS AND FURNITURE

A. REFERENCE

1. REFERENCE AIDS

Gloag, John, A SHORT DICTIONARY OF FURNITURE. (New York: Holt, Rinehart and Winston, 1965).

Hinckley, F. Lewis, DIRECTORY OF THE HISTORIC CABINET WOODS. (New York: Crown Publishers, Inc., 1960).

Kirk, John T., EARLY AMERICAN FURNITURE - HOW TO RECOGNIZE, EVALUATE AND CARE FOR THE MOST BEAUTIFUL PIECES: HIGH-STYLE, COUNTRY, PRIMITIVE AND RUSTIC. (New York: Alfred A. Knopf, 1970).

-----, WOODS. . . .COLORS AND KINDS. (Washington, D. C.: United States Department of Agriculture, 1956).

2. GENERAL WORKS

Dunlap, William, A HISTORY OF THE RISE AND PROGRESS OF THE ARTS AND DESIGN IN THE UNITED STATES. (New York: Dover Publications, Inc., 1969, reprint of 1834 edition).

Hornung, Clarence P., TREASURY OF AMERICAN DESIGN, 2 vols. (New York: Harry N. Abrams, Inc., 1972).

Hume, Ivor Noel, A GUIDE TO ARTIFACTS OF COLONIAL AMERICA. (New York: Alfred A Knopf, 1970).

Menten, Theodore, THE ART DECO SYTLE. (New York: Dover Publications, 1972).

Mumford, Lewis, THE BROWN DECADES: A STUDY OF THE ARTS IN AMERICA, 1865–1895.

Peterson, Harold L., AMERICANS AT HOME. (New York: Charles Scribner's Sons, 1971).

Quimby, Ian M.G., ed., WINTERTHUR PORTFOLIO 7. (Charlottesville: University Press of Virginia, 1972).

Stillinger, Elizabeth, THE ANTIQUES GUIDE TO DECORATIVE ARTS IN AMERICA, 1600-1875. (New York: Dutton and Company, 1972).

Wright, Louis B., et al, THE ARTS IN AMERICA: THE COLONIAL PERIOD. (New York: Charles Scribner's Sons, 1966).

B. EXHIBIT CATALOGUES

CLASSICAL AMERICA, 1815–1845. (Newark Museum, 1963).

MUSEUM OF EARLY SOUTHERN DECORATIVE ARTS, WINSTON-SALEM, NORTH CAROLINA. (reprinted from Antiques, January 1967).

NINETEENTH CENTURY AMERICA: FURNITURE AND DECORATIVE ARTS. (New York: Metropolitan Museum of Art, 1970).

CATALOGUES, INVENTORIES AND PRICE LISTS

-----, CRYSTAL PALACE EXHIBITION ILLUSTRATED CATALOGUE, 1851. (New York: Dover Publications, 1970, reprint of original edition).

Cummings, Abbott Lowell, RURAL HOUSEHOLD INVENTORIES, 1675–1775. (Boston: Society for the Preservation of New England Antiquities, 1964).

Kovel, Ralph M. and Terry H., THE COMPLETE ANTIQUES PRICE LISTS. (New York: Crown Publishers, Inc., 1969).

-----, MONTGOMERY WARD AND COMPANY, CATALOGUE AND BUYERS' GUIDE, SPRING AND SUMMER, 1895. (New York: Dover Publications, Inc., 1969, reprint of original edition).

D. CRAFTS AND CRAFTSMEN

Andrews, Edward Deming and Faith, SHAKER FURNITURE: THE CRAFTSMANSHIP OF AN AMERICAN COMMUNAL SECT. (New York: Dover Publications, Inc., 1937).

Bjerkoe, Ethel Hall, THE CABINET-MAKERS OF AMERICA, THEIR LIVES AND WORKS. (New York: Bonanza Books, 1957).

Burton, E. Milby, THOMAS ELFE: CHARLESTON CABINET MAKER. (Charleston: The Charleston Museum, 1970).

Cornelius, Charles Over, FURNITURE MASTERPIECES OF DUNCAN PHYFE. (New York: Dover Publications, Inc., 1970).

Craig, James H., ARTS AND CRAFTS IN NORTH CAROLINA, 1699-1840. (Winston-Salem: Museum of Early Southern Decorative Arts, 1965).

Heuvel, Johannes, THE CABINETMAKER IN EIGHTEENTH CENTURY WILLIAMSBURG. (Williamsburg: Colonial Williamsburg, 1961).

Kornwolf, James D., M. H. SCOTT AND THE ARTS AND CRAFTS MOVEMENT. (Baltimore: Johns Hopkins Press, 1972).

E. FURNITURE HANDBOOKS OF THE PERIOD

Blackie and Sons, THE VICTORIAN CABINET-MAKER'S ASSISTANT. (New York: Dover Publications, Inc., 1970, reprint of 1853 edition).

Chippendale, Thomas, THE GENTLEMAN AND CABINETMAKER'S DIRECTOR. (New York: Dover Publications, Inc., 1966, reprint of 1762 edition).

Eastlake, Charles., HINTS ON HOUSEHOLD TASTE. (New York: Dover Publications, Inc., 1969, reprint of 1878 edition).

Hepplewhite, George, A CABINET-MAKER AND UPHOLSTERER'S GUIDE. (New York: Dover Publications, Inc., 1969, reprint of 1794 edition).

Hope, Thomas, HOUSEHOLD FURNITURE AND INTERIOR DECORATION: CLASSIC STYLE BOOK OF THE REGENCY PERIOD. (New York: Dover Publications, 1971, reprint of 1807 edition).

F. FURNITURE, GENERAL WORKS

—————, THE AMERICAN HERITAGE HISTORY OF COLONIAL ANTIQUES. (New York: American Heritage Publishing Company, 1967).

Burroughs, Paul H., SOUTHERN ANTIQUES. (New York: Bonanza Books, 1931).

Comstock, Helen, AMERICAN FURNITURE, SEVENTEENTH, EIGHTEENTH, AND NINETEENTH CENTURY STYLES. (New York: Viking Press, 1962).

Eberlein, Harold Donaldson and Cortlandt Van Dyke Hubbard, COLONIAL INTERIORS, FEDERAL AND GREEK REVIVAL. (New York: Bonanza Books, 1938).

Fales, Dean A., Jr., AMERICAN PAINTED FURNITURE, 1660-1880. (New York: E. P. Dutton and Company, 1972).

Lea, Zilla Rider, THE ORNAMENTAL CHAIR, ITS DEVELOPMENT IN AMERICA, 1700-1890. (Rutland, Vermont: Charles E. Tuttle, 1960).

Lynch, Ernest Carlyle, Jr., FURNITURE ANTIQUES FOUND IN VIRGINIA. (New York: Bonanza Books, 1954).

Sack, Albert, FINE POINTS OF FURNITURE: EARLY AMERICAN. (New York: Crown Publishers, Inc., 1950).

—————, SOUTHERN FURNITURE AND SILVER: THE FEDERAL PERIOD, 1788-1830. (Baton Rouge: Anglo-American Art Museum, 1968).

G. FURNITURE, PERIODS AND STYLES

Burton, E. Milby, CHARLESTON FURNITURE, 1700-1825. (Charleston: The Charleston Museum, 1955).

Downs, Joseph, AMERICAN FURNITURE: QUEEN ANNE AND CHIPPENDALE PERIODS. (New York: MacMillan Company, 1952).

Kovel, Ralph M. and Terry H., AMERICAN COUNTRY FURNITURE, 1780-1875. (New York: Crown Publishers, 1965).

Montgomery, Charles F., AMERICAN FURNITURE, THE FEDERAL PERIOD, IN THE HENRY FRANCIS DUPONT WINTERTHUR MUSEUM. (New York: Viking Press, 1966).

Morse, John D., COUNTRY CABINETWORK AND SIMPLE CITY FURNITURE. (Charlottesville: University Press of Virginia, 1970).

Ormsbee, Thomas H., FIELD GUIDE TO AMERICAN VICTORIAN FURNITURE. (Boston: Little Brown and Company, 1951).

Theus, Mrs. Charles M., SAVANNAH FURNITURE, 1735-1825. (Savannah: n. pub., 1967).

H. DECORATIVE ARTS

1. CHINA, PORCELAIN

Beurdeley, Michel, CHINESE TRADE PORCELAIN. (Rutland, Vermont: Charles E. Tuttle, 1962).

Camehl, Ada Walker, THE BLUE-CHINA BOOK. (New York: Dover Publications, 1971, reprint of 1916 publication).

Cox, Warren E., THE BOOK OF POTTERY AND PORCELAIN. (New York: Crown Publishers, 1966).

Hume, Ivor Noel, POTTERY AND PORCELAIN IN COLONIAL WILLIAMSBURG'S ARCHAEOLOGICAL COLLECTIONS. (Williamsburg: Colonial Williamsburg, 1969).

Mankowitz, Wolf and Reginal G. Haggard, THE CONCISE ENCYCLOPEDIA OF ENGLISH POTTERY AND PORCELAIN. (New York: Hawthorn Books, Inc., n.d.).

Miller, J. Jefferson II and Lyle M. Stone, 19TH CENTURY CERAMICS FROM FORT MICHILIMACKINAC. (Washington: Smithsonian Institution Press, 1970).

Towner, Donald, THE LEEDS POTTERY. (New York: Taplinger Publishing Company, 1965).

2. PEWTER AND TIN

Giffen, Jane C. and Ida F. Taggart, PEWTER IN THE COLLECTIONS OF THE NEW HAMPSHIRE HISTORICAL SOCIETY. (Concord: New Hampshire Historical Society, 1968).

Gould, Mary Earle, ANTIQUE TIN AND TOLE WARE, ITS HISTORY AND ROMANCE. (Rutland, Vermont: Charles E. Tuttle Co., 1967).

Kerfoot, J. B., AMERICAN PEWTER. (New York: Bonanza Books, 1924).

3. SILVER

Burton, E. Milby, SOUTH CAROLINA SILVERSMITHS, 1690-1860. (Charleston: The Charleston Museum, 1968).

Cutten, George Barton, THE SILVERSMITHS OF GEORGIA, TOGETHER WITH WATCHMAKERS AND JEWELERS, 1733 to 1850. (n.p.: The Pigeonhole Press, c. 1958).

DeMatteo, William, THE SILVERSMITH IN EIGHTEENTH CENTURY WILLIAMSBURG. (Williamsburg: Colonial Williamsburg, 1966).

Kovel, Ralph M. and Terry H., A DIRECTORY OF AMERICAN SILVER, PEWTER AND SILVER PLATE. (New York: Crown Publishers, 1961).

Robertson, R.A., OLD SHEFFIELD PLATE. (London: Ernest Benn Limited, 1957).

-----, SOUTHERN FURNITURE AND SILVER: THE FEDERAL PERIOD, 1788-1830. (Baton Rouge: Anglo-American Art Museum, 1968).

-----, SOUTHERN SILVER: AN EXHIBITION OF SILVER MADE IN THE SOUTH PRIOR TO 1860. (Houston: The Museum of Fine Arts, 1968).

Wyler, Seymour B., THE BOOK OF OLD SILVER, (New York: Crown Publishers, 1937).

4. MISCELLANEOUS

Adrosko, Rita J., NATURAL DYES AND HOME DYEING. (New York: Dover Publications, Inc., 1971).

American Historical Catalog Collection, LAMPS AND OTHER LIGHTING DEVICES, 1850-1906. (Princeton: Pyne Press, 1972).

Berendsen, Anne et al, TILES: A GENERAL HISTORY. (New York: Viking Press, 1967).

Butler, Joseph T., CANDLEHOLDERS IN AMERICA, 1650-1900. (New York: Crown Publishers, Inc., 1967).

Gillon, Edmund V., Jr., VICTORIAN CEMETERY ART. (New York: Dover Publications, Inc., 1972).

Gould, Mary Earle, EARLY AMERICAN WOODEN WARE, AND OTHER KITCHEN UTENSILS. (Rutland, Vermont: Charles E. Tuttle Co., 1962).

Jacobsen, Charles W., ORIENTAL RUGS, A COMPLETE GUIDE. (Rutland, Vermont: Charles E. Tuttle Co., 1962).

Lichten, Frances, DECORATIVE ART OF VICTORIA'S ERA. (New York: Bonanza Books, 1950).

Little, Nina Fletcher, FLOOR COVERINGS IN NEW ENGLAND BEFORE 1850. (Sturbridge, Massachusetts: Old Sturbridge Village, 1967).

Montgomery, Florence M., PRINTED TEXTILES: ENGLISH AND AMERICAN COTTONS AND LINENS, 1700-1850. (New York: Viking Press, 1970).

Moore, N. Hudson, OLD GLASS, EUROPEAN AND AMERICAN. (New York: Tudor Publishing Company, 1924).

Morse, John D., ed., PRINTS IN AND OF AMERICA TO 1850. (Charlottesville: University Press of Virginia, 1970).

-----, NINETEENTH CENTURY AMERICA: PAINTINGS AND SCULPTURE. (New York: Metropolitan Museum of Art, 1970).

Roth, Rodris, FLOOR COVERINGS IN 18TH CENTURY AMERICA. (Washington, D.C.: Smithsonian Press, 1967).

Thwing, Leroy, FLICKERING FLAMES, A HISTORY OF DOMESTIC LIGHTING THROUGH THE AGES. (Rutland, Vermont: Charles E. Tuttle Company, 1958).

IV. LANDSCAPE ARCHITECTURE

Bolzcius, John Martin, AN EXTRACT OF THE JOURNAL OF JOHN MARTIN BOLZIUS. (London, 1734).

Bonner, James C., A HISTORY OF GEORGIA AGRICULTURE, 1732-1860. (Athens: University of Georgia Press, 1964), Chapter XI, "Gardens and Buildings".

Cooney, Loraine M., compiler, GARDEN HISTORY OF GEORGIA, 1733-1933. (Atlanta: Peachtree Garden Club, 1933).

Downing, A. J., COTTAGE RESIDENCES, RURAL ARCHITECTURE AND LANDSCAPE GARDENING. (n.p.: Library of Victorian Culture, 1967, first published in 1842).

Elliot, Bishop Stephen, Jr., "An Address on Horticulture, 1851," GEORGIA'S PLANTING PRELATE, Herbert B. Owens. (Athens: University of Georgia Press, 1945).

Forman, Henry Chandlee, TIDEWATER MARYLAND, ARCHITECTURE AND GARDENS. (New York: Bonanza Books, 1956).

Griswold, Ralph E., *THE LANDSCAPE SETTING*. (Washington, D.C.: National Trust for Historic Preservation, 1960).

Hazlehurst, Franklin Hamilton, *JACQUES BOYCEAU AND THE FRENCH FORMAL GARDEN*. (Athens: University of Georgia Press, 1966).

Leighton, Ann, *EARLY AMERICAN GARDENS*. (Boston: Houghton Mifflin Company, 1970).

Olmsted, F. L., Jr., and Theodora Kimball, *FREDERICK LAW OLMSTED, LANDSCAPE ARCHITECT, 1822-1903*. (New York: Benjamin Blom, Inc., 1970, reprint of 1922 publication).

Richards, T. Addison, *AMERICAN SCENERY, ILLUSTRATED*, published in *LANDSCAPE ANNUAL*. (New York: Leavitt and Allen, 1854).

Taylor, Raymond L., *PLANTS OF COLONIAL DAYS*. (Williamsburg: Colonial Williamsburg, 1952).

White, Dana F., ed., *FREDERICK LAW OLMSTED: A SOUTHERN EXPOSURE*. (Atlanta: Papers presented at the Southeast American Studies Conference, 1972).

V. PRESERVATION AND RESTORATION TECHNIQUES AND POLICIES

Association for Preservation Technology, *Bulletins of*, (by membership only — Box 2682, Ottawa 4, Ontario, Canada).

—————, *BUILDING RESEARCH*. Vol. 1, No. 5. (September-October 1964).

Bullock, Orin M., Jr., *THE RESTORATION MANUAL*. (Norwalk, Connecticut: Silvermine Publishers, Inc., 1966).

Finley, David E., *HISTORY OF THE NATIONAL TRUST FOR HISTORIC PRESERVATION*. (Washington, D.C.: National Trust for Historic Preservation, 1965).

Frisbee, John L., *HISTORIC PRESERVATION AND THE TOURIST INDUSTRY*. (Washington, D.C.: National Trust for Historic Preservation, n.d.).

—————, *HISTORIC PRESERVATION AND THE BUSINESS INDUSTRY*. (Washington, D.C.: National Trust for Historic Preservation, 1970).

—————, *HISTORIC PRESERVATION PLAN FOR SAVANNAH*. (Savannah: Housing Authority of Savannah, 1968).

—————, *HISTORIC PRESERVATION TOMORROW*. (Washington, D.C.: National Trust for Historic Preservation, 1967).

Historic Sites Survey Team, GEORGIA HISTORIC PRESERVATION PLAN. (Atlanta: Department of Natural Resources)..

Miner, Ralph W., CONSERVATION OF HISTORIC AND CULTURAL RESOURCES. (Chicago: American Society of Planning Officials, 1969).

Montague, Robert L. and Tony P. Wrenn, PLANNING FOR PRESERVATION. (Chicago: American Society of Planning Officials, 1964).

Morrison, Jacob H., HISTORIC PRESERVATION LAW. (Washington, D.C.: National Trust for Historic Preservation, 1965).

National Park Service, A TECHNICAL HANDBOOK FOR HISTORIC PRESERVATION. (in preparation).

-----, NATIONAL REGISTER OF HISTORIC PLACES. (Washington, D.C.: Office of Archaeology and Historic Preservation, National Park Service, 1969, 1972, 1974).

-----, PRESERVATION THROUGH DOCUMENTATION. (Washington, D.C.: Historic American Buildings Survey, 1968).

-----, PRESERVING HISTORIC AMERICA. (Washington, D.C.: Department of Housing and Urban Development, 1966).

Rains, Albert and Laurance G. Henderson, WITH HERITAGE SO RICH. (New York: Random House, 1966).

Rath, Frederick L. and Merrilyn Rogers O'Connell, compilers, GUIDE TO HISTORIC PRESERVATION, HISTORICAL AGENCIES AND MUSEUM PRACTICES: A SELECTIVE BIBLIOGRAPHY. (Cooperstown: New York State Historical Association, 1970).

-----, A REPORT ON PRINCIPLES AND GUIDELINES FOR HISTORIC PRESERVATION IN THE UNITED STATES. (Washington, D.C.: National Trust for Historic Preservation, 1964).

Stanforth, Deirdre and Martha Stamm, BUYING AND RENOVATING A HOUSE IN THE CITY. (New York: Alfred A. Knopf, 1972).

Stephen, George, REMODELING OLD HOUSES WITHOUT DESTROYING THEIR CHARACTER. (New York: Alfred A. Knopf, 1972).

Sykes, Meredith and Ann Falkner, CANADIAN INVENTORY OF BUILDING TRAINING MANUAL. (Ottawa: National Historic Sites Service, 1970).

Ziegler, Arthur P., Jr., HISTORIC PRESERVATION IN INNER CITY AREAS. (Pittsburg: Allegheny Press, 1971).

GA

N200.P6

M1

1974

P7

ug

Cost	\$4,500.00
<hr/>	
Quantity	5,000

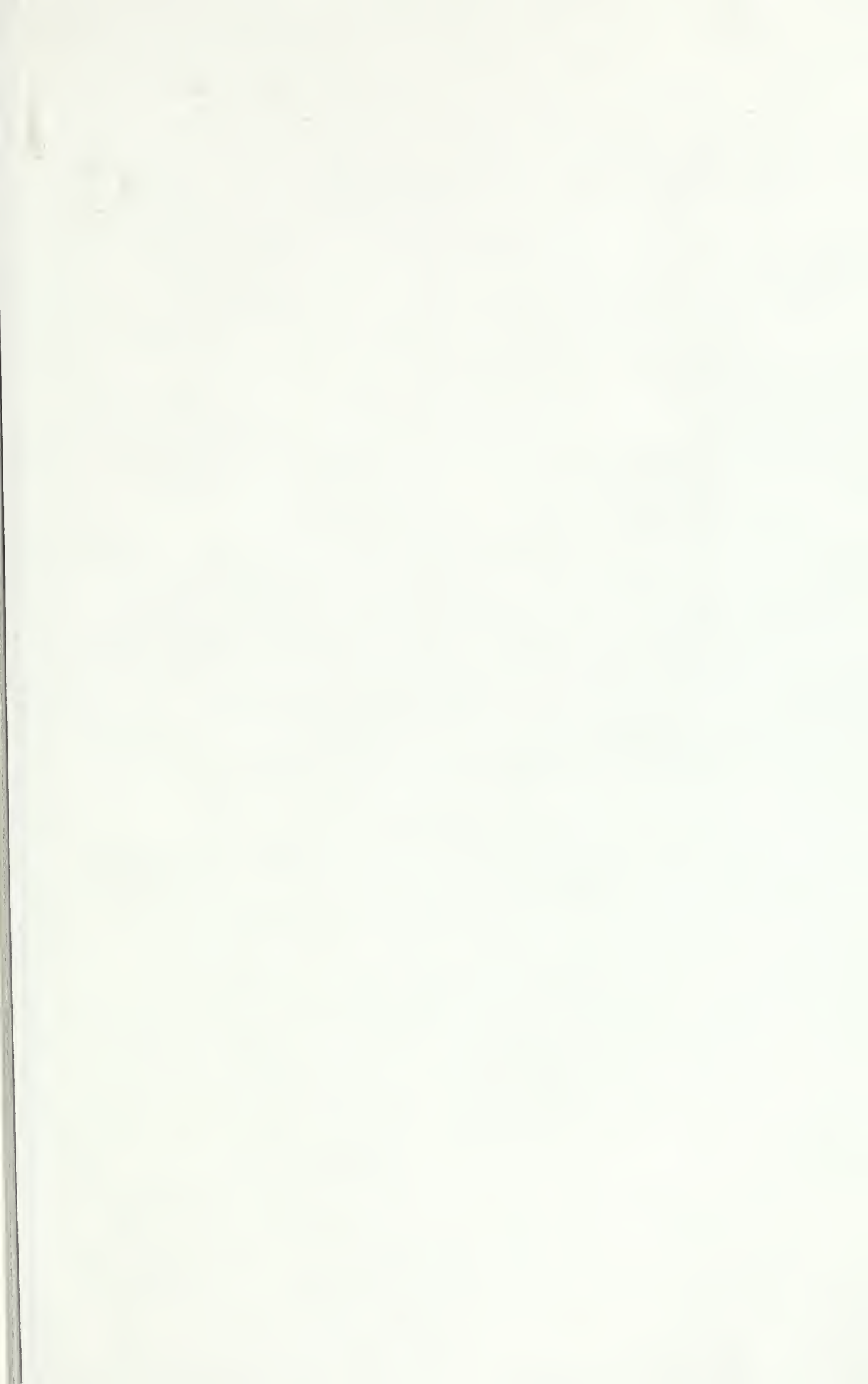

GA
MS00.P6
M1
1974
P7

UNIVERSITY OF GEORGIA LIBRARIES



3 2108 04548 7488

