

Clemson University



3 1604 018 748 501

I 29.2:R 26/v.3



Digitized by the Internet Archive
in 2012 with funding from
LYRASIS Members and Sloan Foundation

<http://archive.org/details/interpretingsecr03nati>

Technical Preservation Services
Preservation Assistance Division
National Park Service
U.S. Department of the Interior
Washington, D.C.

Interpreting
the Secretary of the Interior's
Standards for Rehabilitation

Clemson University
3 1604 019 673 658

PUBLIC DEPOSIT
ITEMS

JAN 5 1989

CLEMSON
LIBRARY



Volume III

Cover illustration: Yokohama Specie Bank (1908-10), Honolulu, Hawaii. Rehabilitated under the historic preservation tax incentives program. Drawing by Michel A. Van Ackere for the Historic American Buildings Survey. 1987.

INTRODUCTION

"Interpreting the Standards" ("ITS") bulletins were initiated in 1980 by the Preservation Assistance Division to explain rehabilitation project decisions made by the National Park Service, U.S. Department of the Interior, in its administration of the historic preservation tax incentives program. Issued at intervals to program administrators in National Park Service regional offices and State historic preservation offices, the first 43 "ITS" bulletins were collected in 1982. Volume II of "Interpreting the Standards" appeared in 1985, and included another 32 bulletins. The present volume adds another 32 bulletins, bringing the total to 107.

Designed primarily for State and Federal program administrators, these bulletins have proved useful to architects, developers, historians, and others involved in the rehabilitation of historic buildings. Consequently, with this volume, "ITS" bulletins are offered for sale to the general public for the first time.

Decisions presented in these bulletins are specific to the circumstances of the rehabilitations involved. They do not accumulate as precedent in the legal sense. The procedures for obtaining certifications of rehabilitation are explained in Title 36 of the Code of Federal Regulations, Part 67. These regulations control in the event of any inconsistency with these bulletins.

The following ten Standards for Rehabilitation are used by the Secretary of the Interior to determine if a rehabilitation project qualifies as a "certified rehabilitation" pursuant to relevant sections of the Internal Revenue Code. The Standards comprise the sole regulatory basis for determining whether or not a rehabilitation is consistent with the historic character of the structure and where applicable the district in which it is located. (The Standards for Rehabilitation, first published in 1977, are undergoing revision as this volume goes to press. The revised text, however, will differ in relatively minor aspects only from the Standards that governed review of the projects discussed in this volume. These Standards are given below.)

1. Every reasonable effort shall be made to provide a compatible use for a property which requires minimal alteration of the building, structure, or site and its environment, or to use a property for its originally intended purpose.
2. The distinguishing original qualities or character of a building, structure, or site and its environment shall not be destroyed. The removal or alteration of any historic material or distinctive architectural features should be avoided when possible.
3. All buildings, structures, and site shall be recognized as products of their own time. Alterations that have no historical basis and which seek to create an earlier appearance shall be discouraged.
4. Changes which may have taken place in the course of time are evidence of the history and development of a building, structure, or site and its environment. These changes may have acquired significance in their own right, and this significance shall be recognized and respected.

5. Distinctive stylistic features or examples of skilled craftsmanship which characterize a building, structure, or site shall be treated with sensitivity.
6. Deteriorated architectural features shall be repaired rather than replaced, wherever possible. In the event replacement is necessary, the new material should match the material being replaced in composition, design, color, texture, and other visual qualities. Repair or replacement of missing architectural features should be based on accurate duplications of features, substantiated by historic, physical, or pictorial evidence rather than on conjectural designs or the availability of different architectural elements from other buildings or structures.
7. The surface cleaning of structures shall be undertaken with the gentlest means possible. Sandblasting and other cleaning methods that will damage the historic building materials shall not be undertaken.
8. Every reasonable effort shall be made to protect and preserve archeological resources affected by, or adjacent to any project.
9. Contemporary design for alterations and additions to existing properties shall not be discouraged when such alterations and additions do not destroy significant historical, architectural or cultural material, and such design is compatible with the size, scale, color, material, and character of the property, neighborhood or environment.
10. Wherever possible, new additions or alterations to structures shall be done in such a manner that if such additions or alterations were to be removed in the future, the essential form and integrity of the structure would be unimpaired.

Bulletins appear in order of issuance. The number assigned to each is composed of the fiscal year in which the bulletin appeared and an overall cumulative number. The index at the end of this volume references all bulletins in the series. (Unfortunately Volumes 1 and 2 are no longer in print.)

This material is not copyrighted and can be reproduced without penalty. However, normal procedures for credit to the authors and the National Park Service are appreciated. Additional information and guidance on technical preservation and rehabilitation techniques for historic buildings may be found in the Preservation Briefs, Technical Reports and other publications developed by the Preservation Assistance Division. For a complete list of titles including prices and GPO stock numbers, write: Preservation Assistance Division (424), National Park Service, P.O. Box 37127, Washington, D.C. 20013-7127.

Interpreting the Secretary of the Interior's Standards for Rehabilitation

Number: 86-076

Applicable Standards: 2. Retention of Distinguishing Architectural Character (nonconformance)

Subject: ASSESSING "PROBLEM USE" HISTORIC STRUCTURES

Issue: While some historic buildings reveal their character immediately through a particular style, through the use of rich materials such as marble and bronze, or through a repetition of ornamental features and decorative detailing, many others do not. The character of utilitarian structures, such as warehouses and jails, may be conveyed through the very simplicity of their form and materials, or through features associated with the historic use of the building.

The contemporary uses some utilitarian structures can serve while preserving their historic character are limited. Historic utilitarian structures have been rehabilitated within the framework of the Secretary's Standards, but the potential limitations for adaptive re-use should be recognized early in project planning. It is important to be aware of the functions they have served over time in order to meet the Standards. As a result of an incomplete assessment of the significance of a structure's historic function to its character, an owner may make changes that compromise its identity.

Application: A jail built in 1887 was proposed for rehabilitation into residential apartments. Located in a historic district, the structure consisted of a warden's house and a cell block (see illus. 1). The exterior of the four-story, 124' x 44' cell block contrasted sharply with the warden's residence, a three-story, late Victorian structure topped by an elongated arched dome that had long been a landmark in the historic district. The stark interior of the cell block reflected the strictly utilitarian character of the structure. The cells, 5' x 8', were separated by 18" load-bearing masonry walls (see illus. 2 and 3). The internal structural system was therefore independent of the exterior walls. To accommodate the insertion of 32 apartments, plans called for the nearly total demolition of the historic floor plan (see illus. 4).

In denying the project certification, the regional office noted that the design proposal would remove:

all signs of the historic plan and structural system along with all interior historic fabric, i.e., stairs, balustrade and newel posts, lattice strap cell doors and riveted steel jambs, etc.
Consequently, this proposal would erase all evidence of the essential form, integrity and sole intent of the building's historic appearance and purpose.

In his appeal, the owner stressed the immense difficulties encountered in converting the building into housing. He stated that only by removing all of the interior fabric could the conversion be accomplished. In the meeting, he also noted that much of this work had already been undertaken, including the removal of the roof (made necessary by the decision to remove the load-bearing cell walls). At the time of the appeal meeting, therefore, the cell block stood roofless with only its perimeter walls in place.

The Chief Appeals Officer agreed with the determination of the regional office that the rehabilitation destroyed all traces of the jail's character as a jail--and thus in large part its very history. The historic function of the cell block was very specific. "Its sole purpose," he wrote, "was embodied in the interior arrangement of the structure." This arrangement "was more than a mere adjunct to the historic resource. It was the most essential component of it. The interior arrangement largely determined the fundamental historic character of this building... and it had survived into the present essentially unaltered." As a consequence of the work undertaken, however, "practically all internal vestiges of the defining historic character have been obliterated." The rehabilitation, therefore, failed the basic statutory test required of every project undertaken on historic buildings for purposes of the Federal historic preservation tax incentives program--that the rehabilitation work must preserve the essential portions and features of the property significant to its historic, architectural and cultural values.

In determining that the rehabilitation did not meet the Standards, the Chief Appeals Officer addressed the underlying question of whether the proposed new use--housing--violated Standard 1 (compatible use). In doing so, he rejected the claim that the conversion of this special-use building to apartments entailed removal of all interior fabric:

Considering whether this specialized building could be converted to housing, admittedly a difficult question, I have come to the opinion that it could have been reasonably successful with imaginative exploration of alternatives to total clearance of the interior of the cell block.

While a design proposal for housing that was more sympathetic to the historic structure would have been approved, the Chief Appeals Officer took the occasion to note that the building would more easily have accommodated other uses, and concluded:

It seems unfortunate that a historic public building of such particular character could not have been retained for an appropriate public use, such as library or archives, that could have been fitted into it with minimal disturbance of its historic arrangement. A creative, affirmative search for alternatives to disposal can sometimes lead to the useful retention of a seemingly redundant historic public building.

Nevertheless, in this case, the denial resulted from the loss of historic character involved in the specific method of inserting residential units into the building rather than from the choice of housing as the use per se.

Prepared by: Michael Auer, TPS

These bulletins are issued to explain preservation project decisions made by the U.S. Department of the Interior. The resulting determinations, based on the Secretary of the Interior's Standards for Rehabilitation, are not necessarily applicable beyond the unique facts and circumstances of each particular case.



1. The property undergoing rehabilitation consisted of a three-story warden's house (partially visible, left) and a four-story cell block.



2. Interior of the cell block. Cells were 5' x 8', separated by 18" load-bearing walls.

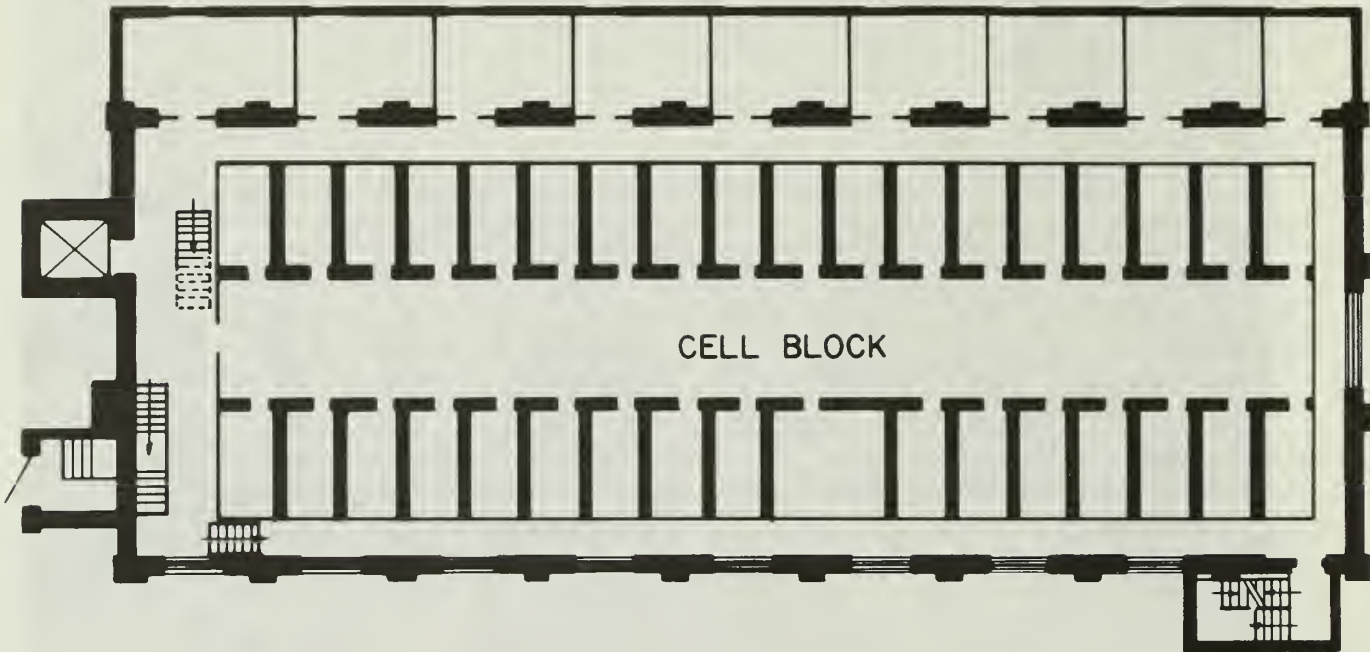

3. Floor plan before rehabilitation. Section at top of page added in the 1950s.

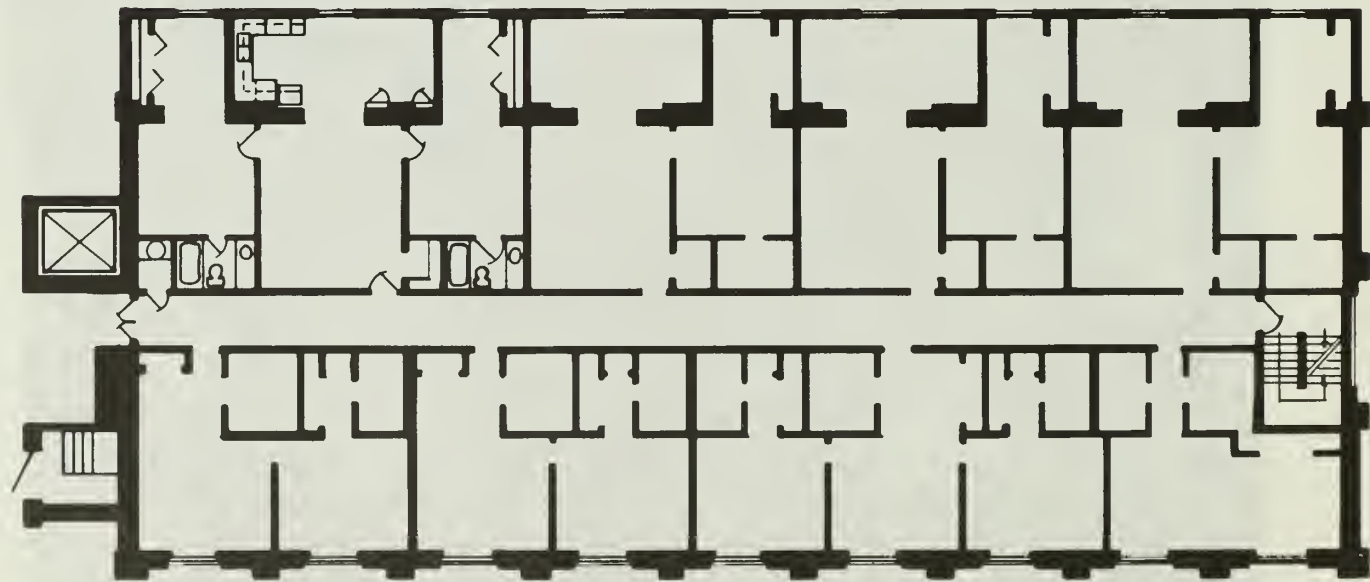

4. Floor plan showing proposed insertion of apartments and removal of nearly all interior fabric.

Interpreting the Secretary of the Interior's Standards for Rehabilitation

Number: 86-077

- Applicable Standards:
1. Compatible New Use (nonconformance)
 2. Retention of Distinguishing Architectural Character (nonconformance)

Subject: ASSESSING UTILITARIAN STRUCTURES TO DETERMINE AN APPROPRIATE RE-USE

Issue: While some historic buildings reveal their character immediately through a particular style, a variety of crafted materials, a striking design, or through a repetition of ornamental features and decorative detailing, many others do not. The character of certain utilitarian structures such as warehouses, ice houses, barns, and jails may, rather, be conveyed through a simplicity of materials, form, features, and detailing which reflects a specific historic use. While architecturally simple, these structures may have played vital roles in a town's commercial, social, or cultural history.

The contemporary uses that some utilitarian structures can serve while preserving their historic character are limited; thus, the potential limitations of re-use should be recognized early in the planning stage. To meet Standards 1 and 2, it is particularly important to be aware of and respect the building's significance as identified in the National Register nomination, one aspect of which is understanding the historical uses and functions it has served over time. Without a complete assessment of a structure's history and character, an owner may inadvertently make changes that compromise its unique identity.

Application: An ice service company determined eligible for National Register listing was being rehabilitated for multi-unit residential use. The property consisted of a one-story rectangular structure built in 1920 that served as offices, an engine room, and coolers; and a 50 foot high windowless, ice storage house added in 1924 (see illus. 1 and 2). The firm manufactured, stored, and supplied "pure" artificial ice made from artesian well water until that service was rendered obsolete by the invention of electric coil refrigeration. The ice storage house had been used since the the 1950s as a lumber warehouse. It is important to note that in spite of changes in use from 1920 to the 1980s the ice storage structure remained "virtually unaltered and stood as rare material evidence of a time in American history when household and commercial operations depended on the delivery of blocks of ice for preservation of foodstuffs."

The Part 2 application outlined a series of changes required to provide light and ventilation for the "problem use" structure, and to make the exterior generally more compatible with newly conferred residential zoning. Specifically, windows and doors were to be cut on two side elevations on four levels and balconies added (see illus. 3). Stair towers would also be constructed to meet fire code requirements. When the State reviewed the application, some concern was expressed about the new windows, but it was felt that overall preservation concerns had been met in the rehabilitation of an unusual structure that might otherwise have been demolished by the city.

Retention of the structural pilasters and interior cork wall sheathing were cited as positive aspects of work, as well as passive energy conservation through solar retrofit.

Disagreeing with the State's recommendation for approval, the regional office denied the project, citing violation of Standards 1 and 2. A letter to the owner stated in part:

Conversion of an ice-storage building...which will probably be listed in the National Register as a rare example of its type...to use as an apartment building is a drastic change in use and requires too many significant changes to the fabric of the building. The distinguishing character of the main part of the building is inherent in the tall, solid brick walls, unrelieved except by pilasters, without window openings. Cutting window and door openings and adding balconies on four levels on the two long sides of the structure significantly alters the original character...The appended stair towers add to the changes...

Because the property had not been formally listed and was therefore ineligible for appeal, the owner requested an administrative review that would provide guidance on possible final certification. In his letter of concurrence with the Region, the Chief of the Technical Preservation Services Division wrote:

After carefully reviewing the documentation provided, I concur...that the proposed rehabilitation does not appear to meet the Secretary of the Interior's "Standards for Rehabilitation." The new window openings would dramatically alter the character of this monolithic structure. Furthermore...I have serious reservations about the building's continued eligibility for the National Register if the proposed rehabilitation is carried out.

Prepared by: Kay D. Weeks

These bulletins are issued to explain preservation project decisions made by the U.S. Department of the Interior. The resulting determinations, based on the Secretary of the Interior's Standards for Rehabilitation, are not necessarily applicable beyond the unique facts and circumstances of each particular case.



1. The historically important 1920s ice company firm consisted of a low rectangular structure together with a 50 foot high, ice storage house. Neither structure may seem to be of particular architectural "attraction." The simplicity of construction and lack of decorative detailing, however, parallel a specific use for that period of our commercial history.



2. Ice storage house prior to rehabilitation. The massive brick structure was historically designed and constructed to be windowless on all four sides in order to enhance thermal efficiency. (The one opening seen near the top of the building is a small attic vent).

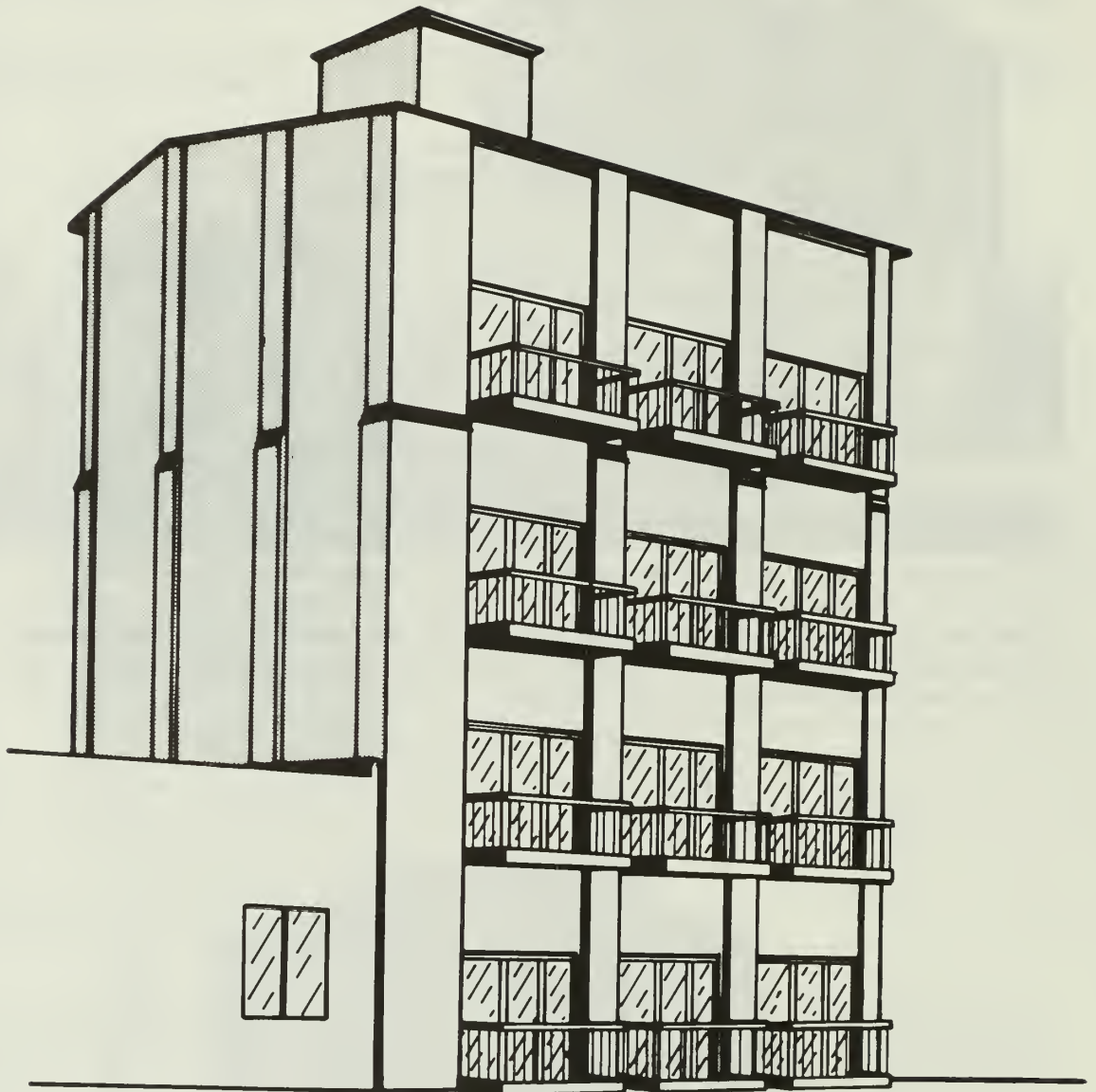

3. The rehabilitation proposal involved cutting windows on two highly visible side elevations and adding balconies. The National Park Service determined that the degree of change to accommodate this particular re-use proposal was not consistent with the historic character of the building; thus, approval was denied.

Interpreting the Secretary of the Interior's Standards for Rehabilitation

Number: 86-078

- Applicable Standards:
4. Retention of Significant Later Alterations/Additions (nonconformance)
 6. Repair/Replacement of Deteriorated or Missing Architectural Features Based on Historical Evidence (nonconformance)

Subject: SELECTIVE RESTORATION OF MISSING HISTORIC FEATURES

Issue: When a significant feature of a historic building is missing at the outset of rehabilitation (for example, a porch, cupola, or storefront), one option is simply to acknowledge the loss as part of the building's history and to repair the remaining materials and features. If documentation exists, however, the recommended approach is to accurately restore the missing feature or features to the primary period of historical significance as identified in the National Register nomination. The documentation used to corroborate the re-building of distinctive missing features generally includes pictorial information (photographs and drawings) as well as physical evidence.

Sometimes an owner may use drawings and photographs of the building as it appeared at various times in its history, then selectively restore missing--and often highly decorative--features from different periods. As a result of using an inconsistent restoration planning approach, an appearance may be created that never existed historically. Thus, it is particularly important to be aware of a building's historical significance, one aspect of which is understanding and respecting those architectural changes that have taken place over time so that a project meets Standards 2 and 4. Incomplete research or the arbitrary use of historical documentation can jeopardize certification of a rehabilitation.

Application: In 1907 a two-story, wood-frame hotel was constructed with a mansard roof featuring multiple dormers, a distinctive cupola, and a double-decked porch on all four elevations (see illus 1). In 1920, the structure was modified; specifically, the dormers and cupola were removed and a full third story created. By the 1980s, the original porch had been reduced to one-story on the front elevation (see illus. 2) and removed entirely from the sides, retaining a small portion of the double porch only on the rear. In spite of the changes over time, the hotel, located on a circle in the center of the small town together with the county courthouse and other key structures, clearly contributed to the significance of the historic district and was certified by the NPS (see illus. 3).

Interior and exterior rehabilitation included the relocation of an existing stair, repair of the primary entrance, restoration of a two-story porch and cupola, construction of a two-story kitchen addition, and painting and general repairs to the guest rooms. When the State initially reviewed the application, additional documentation was requested and some concerns were expressed about interior changes; on balance, however, the project was recommended for certification to the regional office.

The regional office denied the project for nonconformance with Standards 2, 4, 5, and 6. Removal of a portion of the original porch and alteration of the plan of the upper floors were both cited. Central to the denial, however, was the misuse of photographic documentation to restore two significant architectural features missing at the outset of rehabilitation--the porch and the cupola. The region concluded that the restoration as undertaken could not be justified based on the two photographs submitted with the application. One showed the building after construction in 1907 and the other showed it in 1984. The region's letter stated, in part:

Rehabilitation of the hotel includes the restoration of two prominent significant features of the original hotel, its two-tier porch on all four facades and the central cupola surrounded by a balustrade. Pictorial evidence documents that these features existed in an earlier period; however, the building has evolved over time and the pictorial evidence submitted does not support restoration of the cupola...Restoration of the cupola would create a historic looking building that never existed...Restoration of the two-tier porch is similar to the cupola issue. Documentation does not show that double porches ever existed on all facades after the roof was changed...The cupola and porch proposals represent a selective restoration of original significant features and violate Standards 4 and 6.

At the appeal, the owners presented an additional photograph dating from 1920 that had not been part of the application package reviewed by the region showing the hotel without the dormers and cupola, but with the two-story wrap-around porch (see illus. 4). This additional information suggested another valid restoration option reflecting the 1920s modifications. However, upon careful evaluation, the Chief Appeals Officer concluded that the owner's restoration approach had, in fact, not been consistent with any one period in the building's history and therefore did not meet the Standards. In his letter to the owner affirming the region's denial, the Chief Appeals Officer wrote:

During the course of our meeting you provided additional photographs...showing the building fully three stories high, with the later simplified roof line and with the double deck porch, but without the dormers and cupola. The emergence of this photograph offered a third option: to recreate the appearance of the hotel during this intermediate period in the building's history. However, comparison of this 1920 photograph with the views of the work "in progress" presented in the appeal shows that the 1920 appearance of the building has not been achieved...however, a cupola recalling the original cupola has (also) been constructed. The current rehabilitation, therefore, has given the building an appearance not known to have existed historically, for no evidence has been brought to light conclusively indicating that the cupola still existed after the roof had been changed to one slope and the walls had been raised to full three stories in height.

In the final paragraphs of this letter, the Chief Appeals Officer suggested that the project might be brought into conformance if the owner would agree to remove the cupola in order to restore the historically valid 1920 appearance of the hotel.

Prepared by: Kay D. Weeks, TPS

These bulletins are issued to explain preservation project decisions made by the U.S. Department of the Interior. The resulting determinations, based on the Secretary of the Interior's Standards for Rehabilitation, are not necessarily applicable beyond the unique facts and circumstances of each particular case.

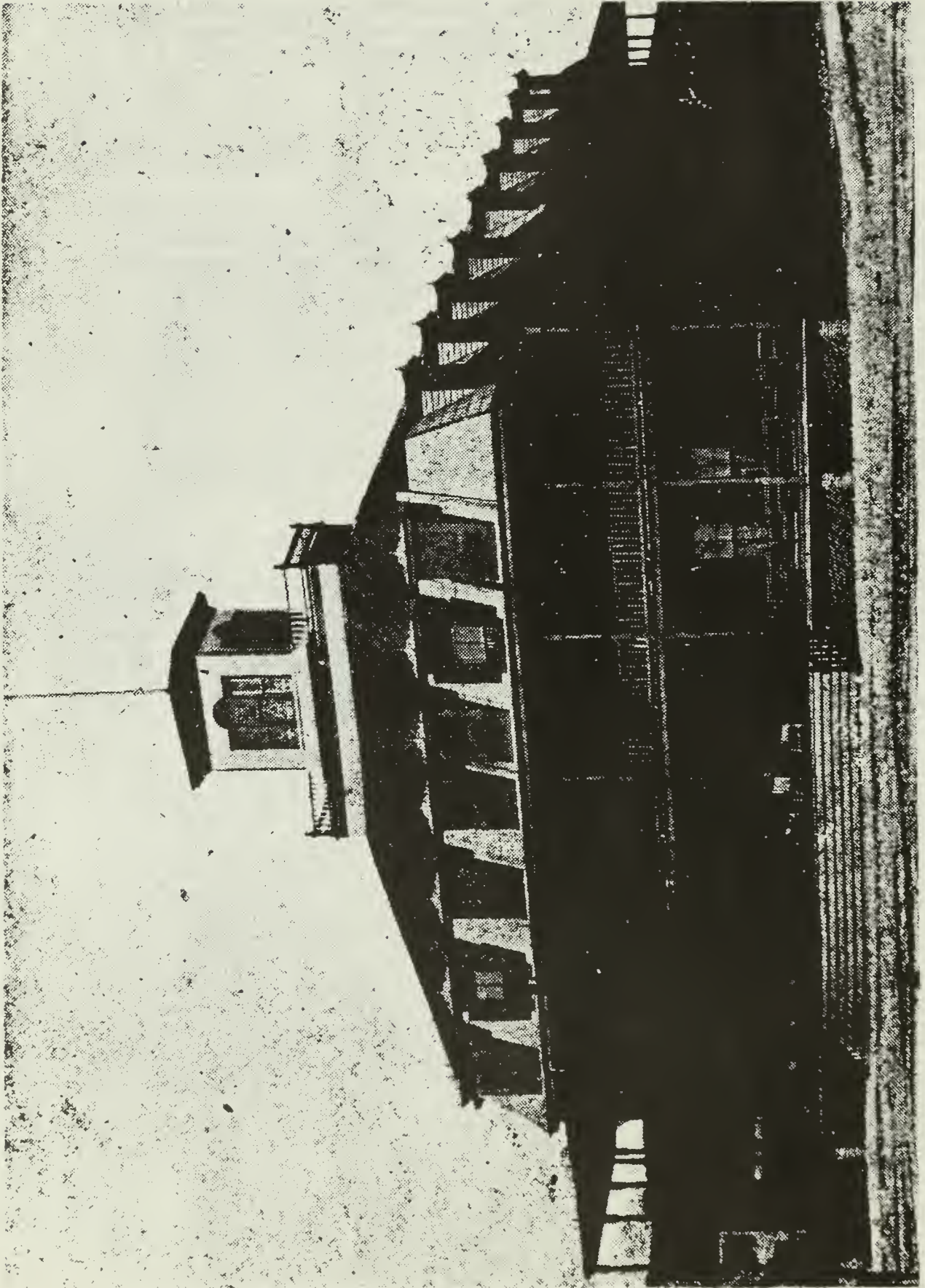

1. Photographic documentation showing the hotel after construction in 1907. Distinctive features include a double-decked porch, a series of dormers, and cupola.



2. The hotel in 1984, prior to rehabilitation. The cupola and dormers are missing, and although a one-story front porch spans the primary elevation, it bears little resemblance to the two-story historic porch shown in the 1907 photograph. The hotel was certified as contributing to the significance of the historic district in its existing condition.



3. The hotel structure in 1984--shown from the steps of the county courthouse--a key structure at the edge of the small town since its original construction in 1907.

THE SPORTSMAN'S
PARADISE FOR HUNTING AND
FISHING

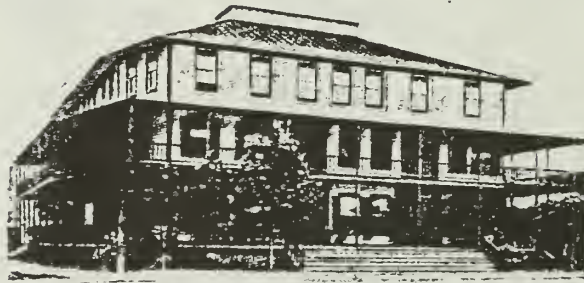

A COMFORTABLE HOME FOR TRAVELERS

4. An advertisement of the hotel dating from c. 1920, showing the building in an intermediate stage of its evolution over time. Note the cupola is missing; the dormers and mansard roof have been removed as part of an interior change to create a full third story. The highly distinctive two story wrap-around porch, however, remains.



5. Hotel under rehabilitation for tax benefits. The restored cupola and two story front porch can be seen. On appeal, the Region's denial was upheld. There was neither photographic documentation nor physical evidence to support restoration of the building to the appearance shown here. The result was a "selective" restoration of architectural features that--while commercially appealing--could not be historically documented to the 1907 or the 1920 appearance.

Interpreting the Secretary of the Interior's Standards for Rehabilitation

Number: 86-079

- Applicable Standards:
2. Retention of Distinguishing Architectural Character (conformance)
 9. Compatible Design for New Alterations/Additions (nonconformance)
 10. Reversibility of New Alterations/Additions (conformance)

Subject: COMPATIBILITY VERSUS REVERSIBILITY IN NEW ADDITIONS TO HISTORIC BUILDINGS

Issue: Standards 2, 9, and 10 of the Secretary of the Interior's "Standards for Rehabilitation" are used in the evaluation of new additions to historic buildings. It is important that a new addition be designed and constructed so that the character-defining features of the historic building are not radically changed, obscured, damaged, or destroyed in the process of increasing the building's size. This means that the new addition should be compatible with the historic building in terms of mass, materials, relationship of solids to voids, and color. The size and scale of the addition should also respect the historic building, and be attached if possible to the rear or an inconspicuous side. Further, new additions to structures should be reversible so that if removed in the future, the essential form and integrity of the structure would be unimpaired.

Occasionally architects and owners will propose an addition to a historic building which they argue could be removed at a future date without damaging the basic form and integrity of the structure. Often the materials used in these additions, such as glass, canvas and clear plastic, are cited as proof that the additions are temporary. The issue, however, is not the permanence or impermanence of the materials used to construct the addition. If an addition adversely alters the character of the historic building, regardless of its presumed reversibility or temporary nature, the project will be denied certification. Rehabilitations must meet all applicable Standards to receive certification.

Application: A small, circa 1900 railroad depot which is individually listed on the National Register was rehabilitated as a restaurant. The character and picturesque quality of this depot prior to rehabilitation (see illus. 1) was largely defined by the conspicuous, slate-covered, hipped roof that projected broadly beyond the exterior walls to shelter the station's platform. The exterior walls on four sides of the building were decoratively treated with a quarry-faced limestone foundation, smooth red brick, and limestone stringcourses and window moldings. The use of these multi-colored materials and architectural features such as arched windows, leaded glass transoms, and wood brackets on stone corbels served to link the visually rich exterior walls with the prominent roof.

In order to make the project economically feasible, a new addition to the depot was built to increase the seating capacity of the restaurant. An addition with large plastic windows with striped plastic walls and roof was constructed around almost half of the depot's exterior walls and was attached along the eaves of the building. Awnings were hung from the eaves around the remaining half of the building (see illus. 2).

The project was denied certification by the NPS regional office on the basis that the rehabilitation violated Standards 2 and 9. In the letter of denial to the owner, the Regional Director stated that the addition and awnings obscured exterior, decorative architectural features and had altered the building's historic form.

The owners appealed the denial, stating that the addition did not destroy nor obscure historic fabric. The owners contended that the architectural features were visible inside the new addition, and that the addition and awnings were carefully designed to result in little or no damage to the historic fabric of the building, therefore meeting Standard 10.

The Chief Appeals Officer agreed with the owner that the addition and awnings resulted in no damage to significant historic fabric, and was therefore technically reversible. However, the regional office's denial of certification was affirmed. The Appeals Officer agreed that the rehabilitation did not meet Standard 9, which specifically states that alterations and additions "shall not be discouraged when the design is compatible with the size, scale, color, material and character of the property" Although the architectural features and building materials of the wide overhang and the historic exterior walls were visible inside the new addition and behind the awnings, their relationship to the design and form of the overall building had resulted in the loss of the historic character of the exterior of the depot. As the Appeals Officer stated in his letter to the owner:

Whether it is a temporary, reversible addition or a more permanent addition to the building, it is fundamentally incompatible in size, form, and detail with historic character of the historic depot. Since the addition obscures and alters such a substantial portion of the historic building's significant exterior, I have to conclude that the rehabilitation is not consistent with the historic character of the building.

Prepared by: Jean E. Travers

These bulletins are issued to explain preservation project decisions made by the U.S. Department of the Interior. The resulting determinations, based on the Secretary of the Interior's Standards for Rehabilitation, are not necessarily applicable beyond the unique facts and circumstances of each particular case.



1. Pre-rehabilitation view of building from railroad tracks: Note brackets, stone corbels and stringcourses. These features occur on all sides of the building.



2. Post-rehabilitation view of the new addition and awnings from street. The addition and awnings obscure a substantial portion of the exterior.



Interpreting the Secretary of the Interior's Standards for Rehabilitation

Number: 87-080

- Applicable Standards:
2. Retention of Distinguishing Architectural Character (nonconformance)
 5. Sensitive Treatment of Distinctive Features and Craftsmanship (nonconformance)
 9. Compatible Contemporary Design for New Alterations/Additions (nonconformance)
 10. Reversibility of New Alterations/Additions (nonconformance)

Subject: INCOMPATIBLE ALTERATIONS TO HISTORIC RESIDENTIAL INTERIOR SPACES

Issue: Historic residential interiors often contain highly decorative architectural features such as mantels, woodwork, ceiling medallions and crown moldings that are readily recognized by owners and architects as significant and therefore worthy of preservation. However, when assessing the historic character of interiors prior to rehabilitation, the spaces themselves are often overlooked. Important spatial qualities can include a room's proportions, defined by ceiling and wall dimensions, the size and number of openings between rooms, and the arrangement of rooms that link spaces on a particular floor. Just as any alteration to a historic interior needs to preserve important architectural features, such an alteration needs to be compatible with significant spatial qualities. Alterations which adversely alter or destroy important interior spaces with new partitions, or floor and ceiling cuts--while perhaps not destroying decorative features such as mantels--may still result in loss of the interior's historic character. Projects in which this occurs will not meet Standards 2, 5, 9, and 10 and may therefore result in denial of rehabilitation certification.

Application: A four-story duplex townhouse, originally designed as a single family dwelling, was rehabilitated into five apartments (see illus. 1). This townhouse possessed a high degree of integrity and architectural distinction prior to rehabilitation. Although the building had been used as a roominghouse since 1930, and vacant for four years prior to acquisition by the present owner, the significant interior spaces, finishes and features were remarkably intact. Of particular significance was the second floor with its three parlor rooms which retained crown moldings, pocket doors and mantels. Of equal importance in defining the historic character of the interior were the interior spatial qualities. These three parlor rooms were designed as a sequence of large square rooms divided by pocket doors.

The project work on the building's exterior was sensitively done. The exterior of the building was gently cleaned and selectively repointed. The historic windows were repaired. However, several incompatible alterations occurred to the interior of the townhouse to accommodate the five apartments. The basement was subdivided, and the staircase was removed to permit the introduction of two units and the bedroom of

a third duplex unit, the main living spaces of which are on the second floor. The second floor, the most architecturally significant portion of the interior, sustained substantial amounts of new construction (see illus 2-7). A freestanding closet was installed in the first parlor. A large stair and kitchen were constructed in the center parlor, and a bath, utility and storage room were placed in the rear parlor. Although the third and fourth floor rooms, originally serving as bedrooms, were more simple in their architectural detailing, substantial alterations and removal of historic fabric nevertheless occurred (see illus 8-11). Entrance doors from the hallways to these rooms were removed and new entrances created. The closets and interior walls separating the bedrooms were removed to allow for a new interior plan dividing this space on the third and fourth floors into two, two-story (duplex) apartments. Two new staircases were also constructed in this space. The historic staircase and stairhall were maintained on the third floor, but removed on the fourth to accommodate new bathrooms. In reviewing the rehabilitation application, it was the Regional Director's finding that these interior alterations resulted in substantial loss of historic fabric and incompatible alterations to the building. The project was denied rehabilitation certification on the basis of Standards 2, 5, 9, and 10.

The owner appealed the region's decision, emphasizing the retention of significant historic fabric on the exterior and interior. Crown moldings, mantels and pocket doors were repaired and retained. New construction was placed away from historic walls and ceilings in almost all cases so that new partitions would not abut crown moldings and baseboards. The owner insisted that the majority of historic interior walls and spaces had been retained and all distinguishing architectural features preserved to the extent that if the new construction were to be removed in the future, the historic character of the interior would remain.

The Chief Appeals Officer agreed with the Regional Office and affirmed the denial of rehabilitation certification. In his letter to the owner, the Chief Appeals Officer described the significant spaces of the interior and how they had been changed by the rehabilitation.

Although it is evident that efforts were made in the rehabilitation to avoid destroying ornamental features such as crown moldings and pocket doors, I find that the alterations have in fact damaged the overall historic character of this building's significant spaces. Although historic interior walls remain on the second floor and in the third and fourth floor hallway, large amounts of historic fabric nevertheless were sacrificed to allow for the new room plan on the third and fourth floors and for the intrusion of three new staircases in the building. I find the alterations to the parlor floor the most destructive. The three formal rooms, historically of approximately equal size, have been significantly altered by new construction. The new construction in the center room, effecting the most severe intervention in terms of the amount of new building and loss of historic fabric, has further altered the original spatial qualities of the second floor overall. Although the rear room is still partially visible from the front room, I find the new kitchen wall and stair balustrade in the center room so invasive as to destroy the sequence of space that this series of rooms was consciously designed to envelope. The alteration to the parlor floor is sufficiently

damaging to the character of this building that I would have upheld the regional office on that change alone. Therefore, it is my determination that the rehabilitation is not consistent with the historic character of the building and that it fails to meet Standards 2, 5, 9, 10.

Prepared by: Jean Travers, TPS

These bulletins are issued to explain preservation project decisions made by the U.S. Department of the Interior. The resulting determinations, based on the Secretary of the Interior's Standards for Rehabilitation, are not necessarily applicable beyond the unique facts and circumstances of each particular case.



1. Building facade: This duplex rowhouse featured a formal series of 3 parlor rooms on the 2nd floor.

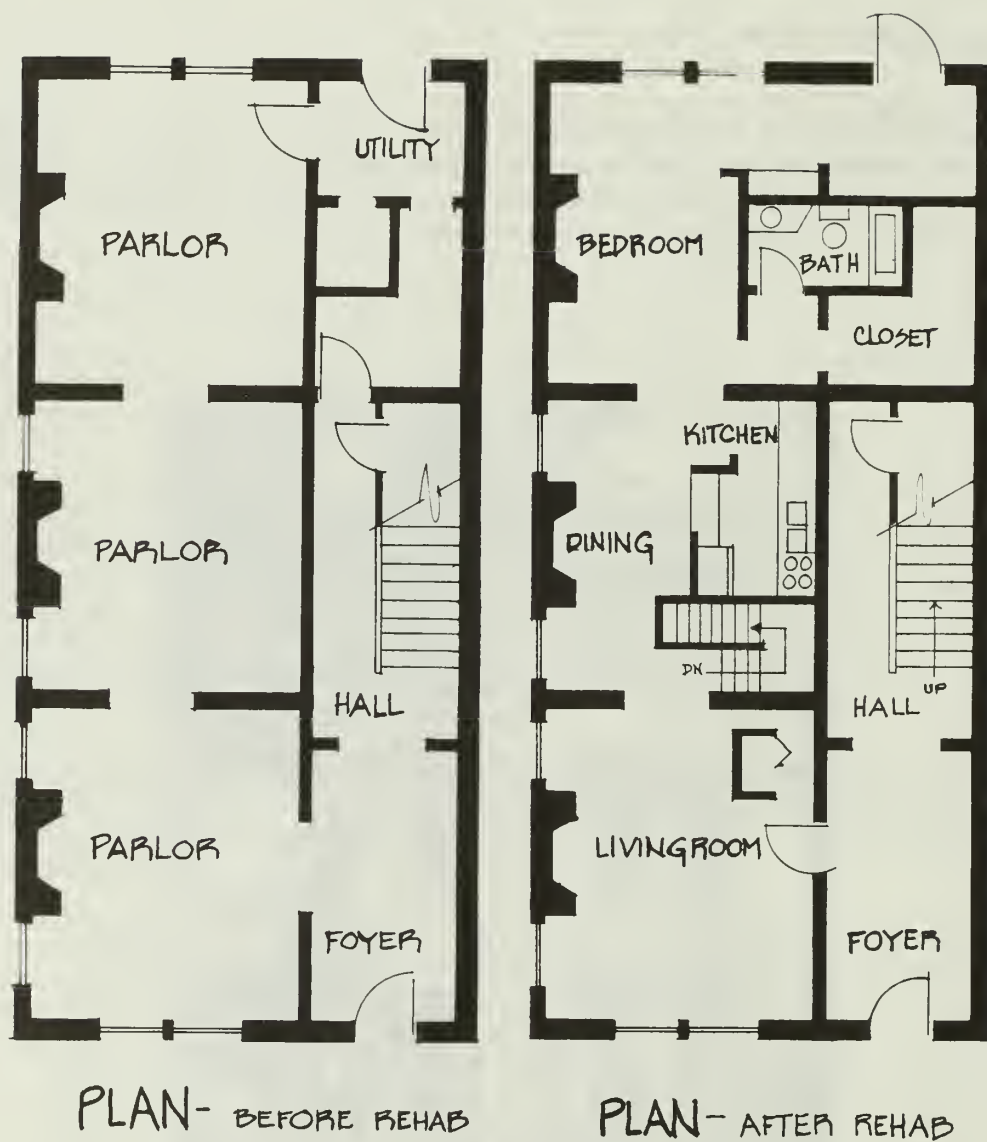

2. 2nd floor plan: Originally a side hall plan with 3 parlor rooms all of similar dimensions. Note extensive new construction in these rooms, especially stair and kitchen in center parlor room, and new wall for bathroom in rear parlor.



3 and 4. Pre-rehabilitation: 2nd floor.
Note view through 3 parlor rooms divided by pocket doors.
Center parlor room below now houses a staircase and kitchen.





5. Post-rehabilitation: 2nd floor. Note new staircase and partition in center parlor room, new freestanding partition to the right of parlor door in front room.



6. Work in progress: Center parlor. New partition wall for kitchen designed not to abut historic ceiling, yet is centrally located in room



7. Post-rehabilitation: Rear parlor room. New partition divides previously square room.



8 and 9. Fourth floor room, pre-rehabilitation (left) and in-progress (above). Note the insertion of the new staircase into the original bedroom in the post-rehab view.





10. Work in progress on third floor showing penetration of wall between historic bedrooms, new staircase inserted in room and view to fourth floor above.



11. Post-rehabilitation view of original staircase maintained as a part of rehabilitation, but fourth floor is floored above, preventing access.

Interpreting the Secretary of the Interior's Standards for Rehabilitation

Number: 87-081

Applicable Standard: 2. Retention of Distinguishing Architectural Character (conformance)

Subject: INTERIOR ALTERATIONS RESULTING IN LOSS OF AIR/LIGHT SHAFT

Issue: Standard 2 of the Secretary of the Interior's "Standards for Rehabilitation" states that "the distinguishing original qualities or character of a building, structure or site and its environment shall not be destroyed." The interior of a historic building contains many different features that may be character-defining, including obviously decorative features or examples of fine craftsmanship such as doors, moldings, stairways, mantles and plasterwork, but equally important to the historic character of a building may be its layout, which includes the floor plans and the way in which rooms and other interior features are arranged. In many cases, it may be as important to preserve the general building layout as it is to preserve the historic shape of the building, including voids or spaces which may contribute to this shape. However, there are some instances when openings (voids or spaces) in historic building may not be character-defining. In such instances, and particularly if these spaces no longer serve the purpose for which they were originally designed, it may sometimes be acceptable and in conformance with the Standards to eliminate them in the rehabilitation.

Application: A modest two-story, turn-of-the-century rowhouse which was built in 1902 originally as working-class housing, contained four "railroad" flats, two on each floor separated by a center vestibule and stair, and a lightshaft in the rear (see illus. 1). Rehabilitation plans appropriately called for the retention of the four units. However, although the basic "railroad" plans were retained for each flat (despite some relatively minor changes), rehabilitation did result in the elimination of a narrow (approximately three feet) enclosed light shaft which separated the two sets of flats (see illus. 2). The National Park Service acknowledged that the narrow light shaft had lost its function and did not meet minimum standards for light and air, but noted that this alone did not justify its removal since Department of the Interior regulations state that "the Standards take precedence over other regulations and codes in determining whether the historic character of the building is preserved in the process of rehabilitation. . ." Thus, the necessity of meeting health and safety code requirements is not a factor taken into consideration by the National Park Service in its review of a rehabilitation project. More importantly, the National Park Service determined that obliteration of the lightshaft did not result in significant changes to the floor plan, nor did it alter the character-defining features of the exterior. The "exterior continues to contribute to the significance of the historic district in which it is located, and the interior still preserves its original center-entrance plan." In short, the rehabilitation was determined to be in conformance with the Standards because "those components that are important in defining its character have been retained."

87-081

In a second, very similar project, lightshafts in two identical turn-of-the-century apartment buildings were also determined not to be character-defining (see illus. 3). Although originally utilitarian (primarily as ventilating shafts for the bathrooms), when the buildings were constructed about 1900, these shafts had never been very effective at providing light to the stairs or bathrooms in these three-story buildings because of their narrowness. Over the years the six original apartments had been subdivided, and the rehabilitation plans called for the creation of additional units which would result in completely eliminating the airshafts. The National Park Service determined that the airshafts or lightwells were not significant character-defining features. "Because the proposed changes in apartment layout eliminated the original need for these lightwells they were rendered useless. Of course, the fact that an existing element of a building is suddenly without purpose is generally not sufficient reason to dispense with it, if it is significant. However, in the case of these buildings, the lightwells were not particularly significant or character-defining features, since they lacked notable distinction in design, workmanship and materials."

Prepared by: Anne Grimmer, TPS

These bulletins are issued to explain preservation project decisions made by the U.S. Department of the Interior. The resulting determinations, based on the Secretary of the Interior's Standards for Rehabilitation, are not necessarily applicable beyond the unique facts and circumstances of each particular case.

1. Original floor plan showing the two first floor "flats" separated by center staircase and lightshaft. Note that lightshaft was completely enclosed, and not visible from the rear of the building.

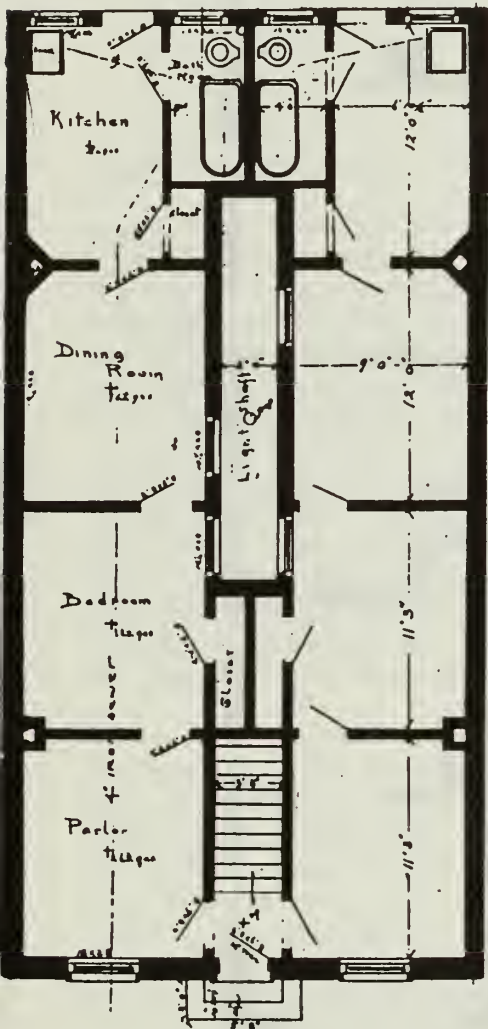

Original Plan
1st Floor

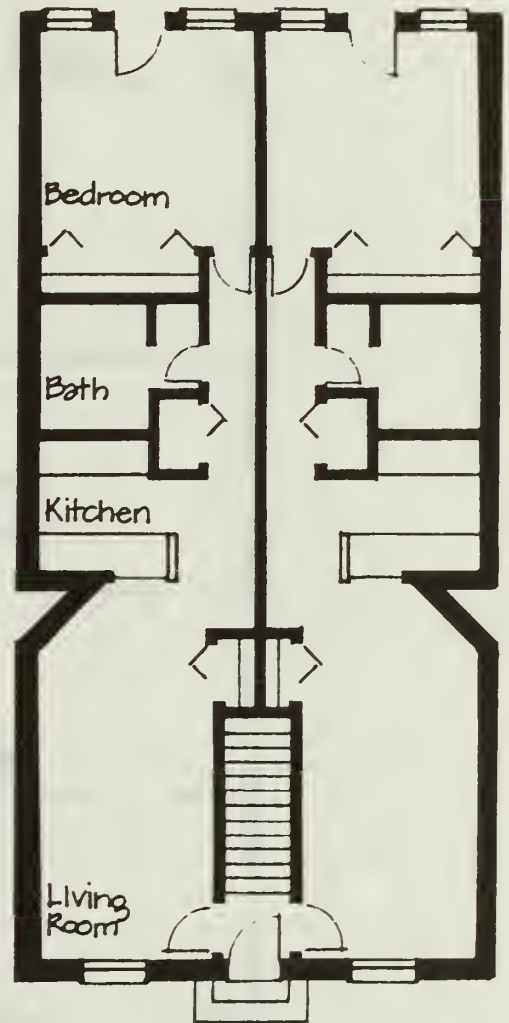

New Plan
1st Floor

2. New floor plan after rehabilitation shows that although lightshaft has been eliminated, basic concept of "railroad flat" remains.

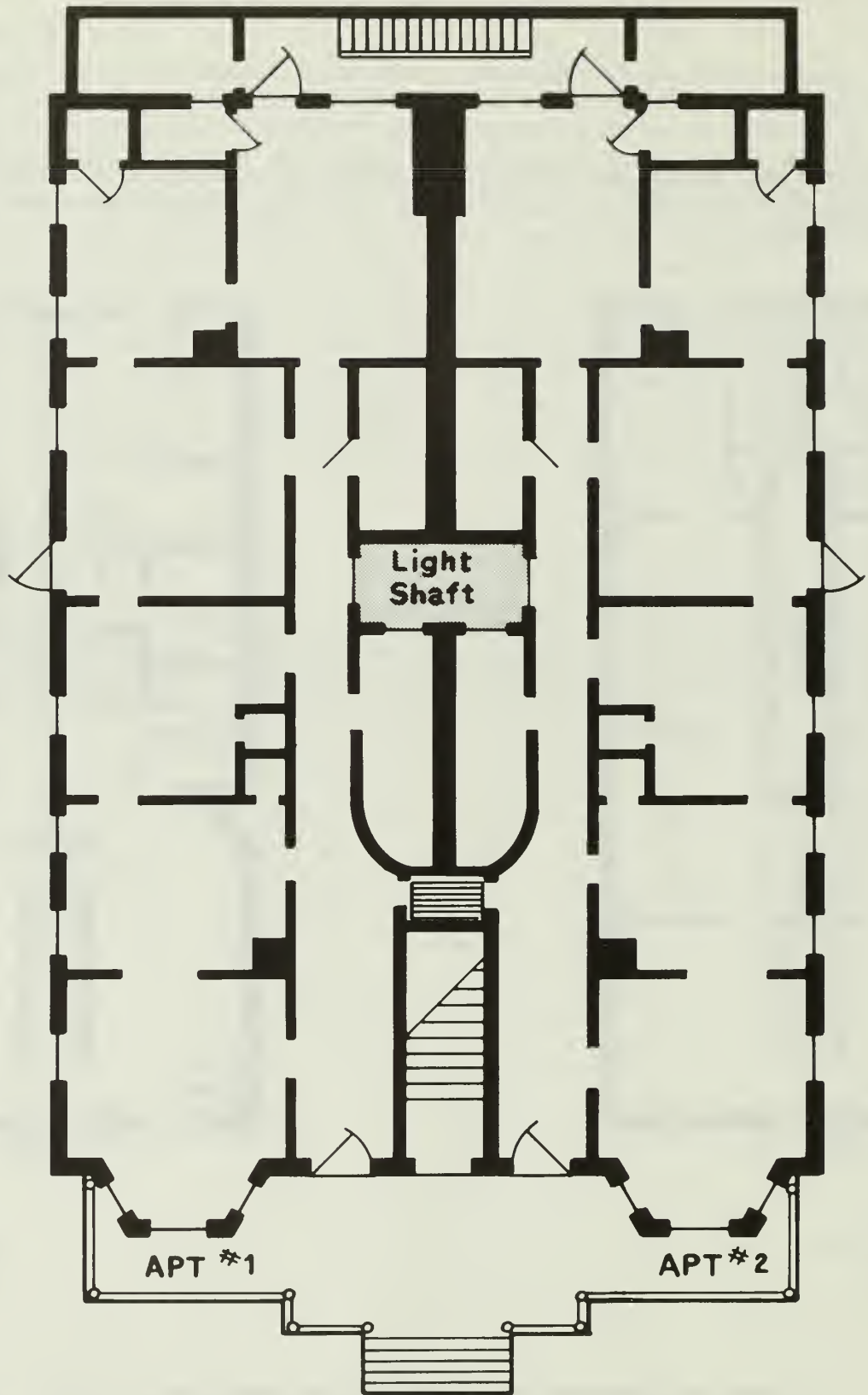

3. This original floor plan shows the lightshaft (shaded) that was determined not to be a character-defining feature and therefore eliminated in the rehabilitation of these two identical apartment buildings.

Interpreting the Secretary of the Interior's Standards for Rehabilitation

Number: 87-082

- Applicable Standards:
2. Retention of Distinguishing Architectural Character
 5. Sensitive Treatment of Distinctive Features and Craftsmanship
 6. Repair/Replacement of Deteriorated or Missing Features

Subject: ALTERATIONS TO INTERIOR LAYOUTS

Issue: Floor plans are often of prime importance in defining the historic character of historic buildings. Indeed, in some cases, the floor plan defines the building type. Such is the case with "shotgun" cottages, marked by the linear arrangement of rooms that gives the form its name. Although alterations to the plan of such structures undergoing rehabilitation are possible within the framework of the Secretary of the Interior's "Standards for Rehabilitation," the basic interior layouts of these modest structures must be respected, particularly when they have survived intact.

Applications: Both projects discussed here are double "shotgun" cottages whose characteristic room arrangement remained intact despite some deterioration of features and finishes (see illus. 1 and 2). The first was built ca. 1900; the second dates from ca. 1890. The original plan of each building is a rectangle having a dividing party wall down the middle with four rooms arranged in linear fashion on each side. Sheds containing bathrooms had been added onto the rear of each building (see illus. 3 and 4). Each building was rehabilitated for continued use as residential apartments.

In the first case, the "shotgun" plan was generally retained in the rehabilitation with some modifications (see illus. 5). Kitchens were inserted into the second room of each half of the duplex; a bathroom and laundry were inserted into the third room. The fourth room in each half of the building was enlarged by moving the partition forward a few feet. Despite these alterations, the division of the building into two equal units was respected in the rehabilitation. Within each half of the double cottage, the interior arrangement of small rooms, one behind the other, was also maintained. Thus, on both the exterior and the interior, the building appears as it appeared historically, as a modest double cottage in the "shotgun" style. This plan largely determined its historic character, which remains following the rehabilitation. The project meets the "Standards for Rehabilitation."

In the second case, radical changes made during the rehabilitation obliterated the characteristic interior plan (see illus. 6). The separation between the two front rooms was destroyed to create one larger room in place of the double parlor arrangement. In

87-082

order to enlarge the apartments, the plan was further altered by incorporating almost the entire rear half of the right unit into the left unit. The floor space lost to the right unit was regained through the addition of a stair to the attic, into which two bedrooms were added. In this project the damage done to the historic character of this modest building is extreme. The units no longer convey a sense of the original "shotgun" plan. Construction of the stair in the right unit has further drastically altered the structure by introducing a vertical element missing from the historic plan. Finally, the division between the halves of the building was effectively destroyed in the rear half of the building. Accordingly, the project fails to meet the Secretary of the Interior's "Standards for Rehabilitation."

Prepared by: Michael J. Auer, TPS

These bulletins are issued to explain preservation project decisions made by the U.S. Department of the Interior. The resulting determinations, based on the Secretary of the Interior's Standards for Rehabilitation, are not necessarily applicable beyond the unique facts and circumstances of each particular case.



1 and 2. Circa 1900 double "shotgun" cottage (above) and circa 1890 double "shotgun" cottage.



87-082

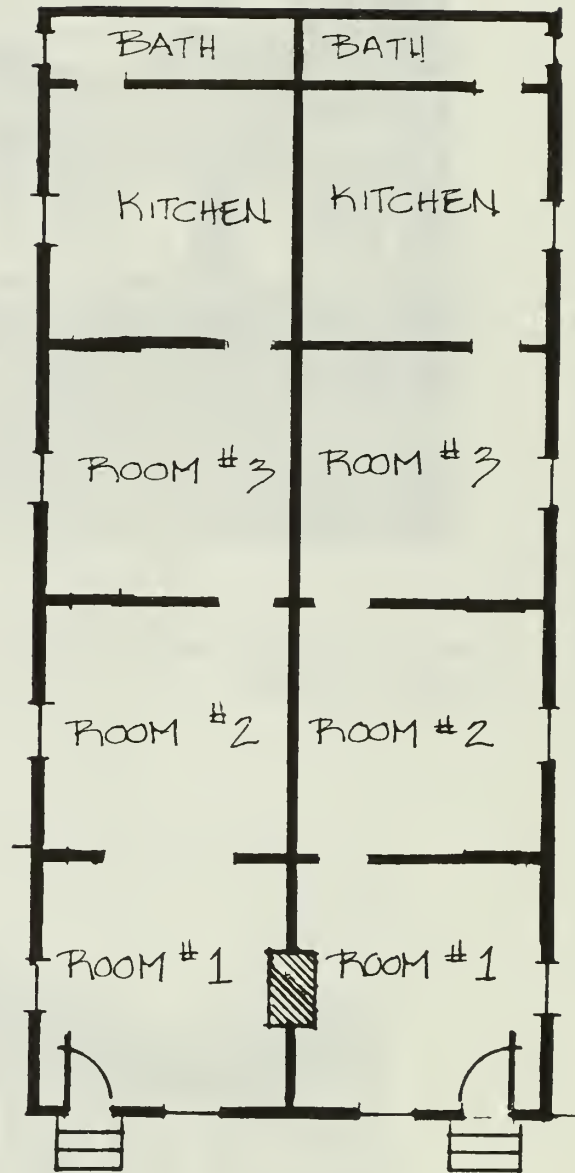
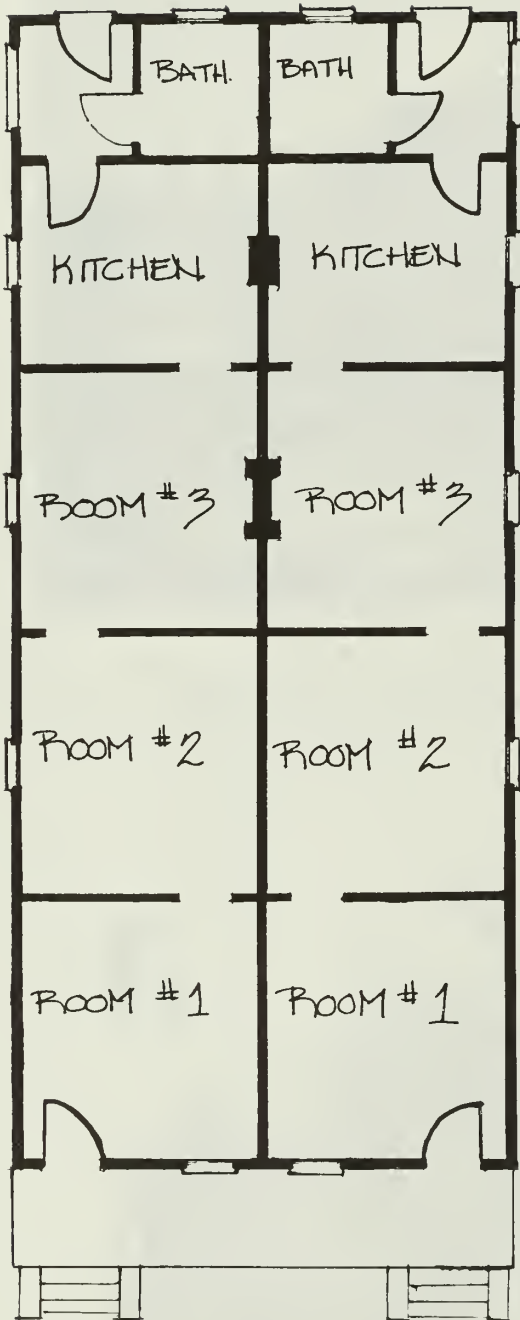

3 and 4. Before rehabilitation floor plans of 1900 building (left) and 1890 building (right).

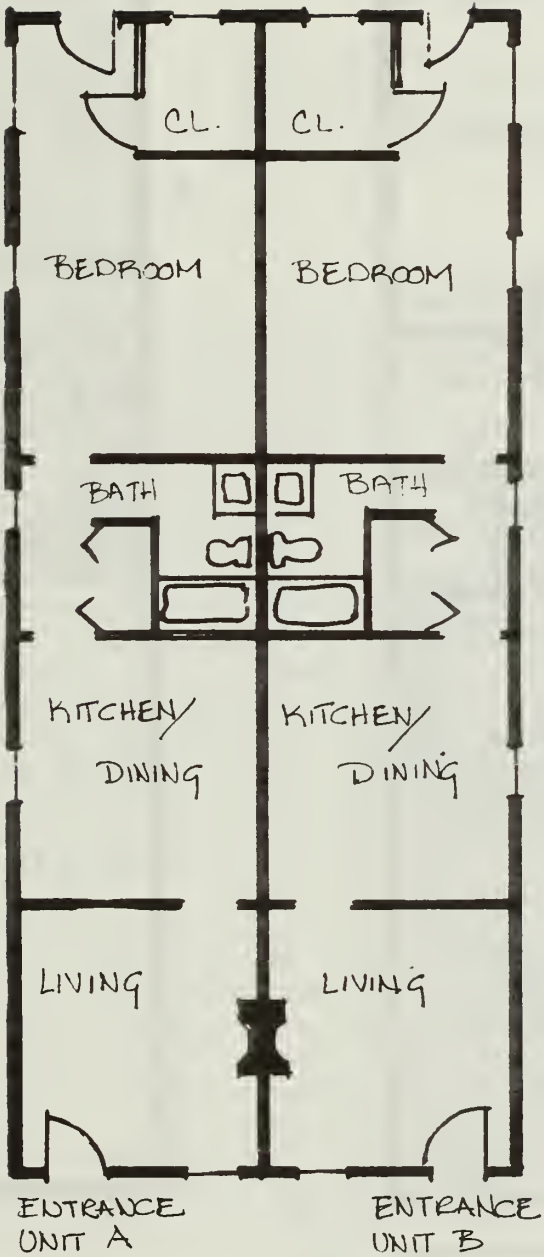

5. After rehabilitation floor plan of 1900 building.

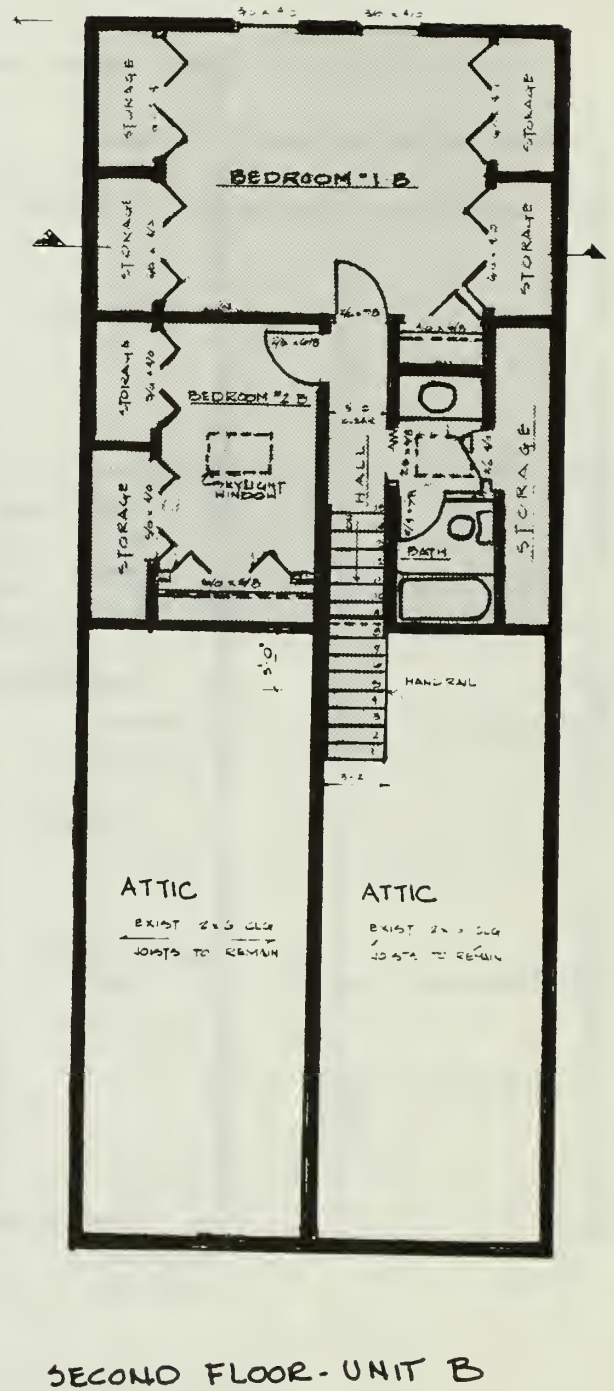
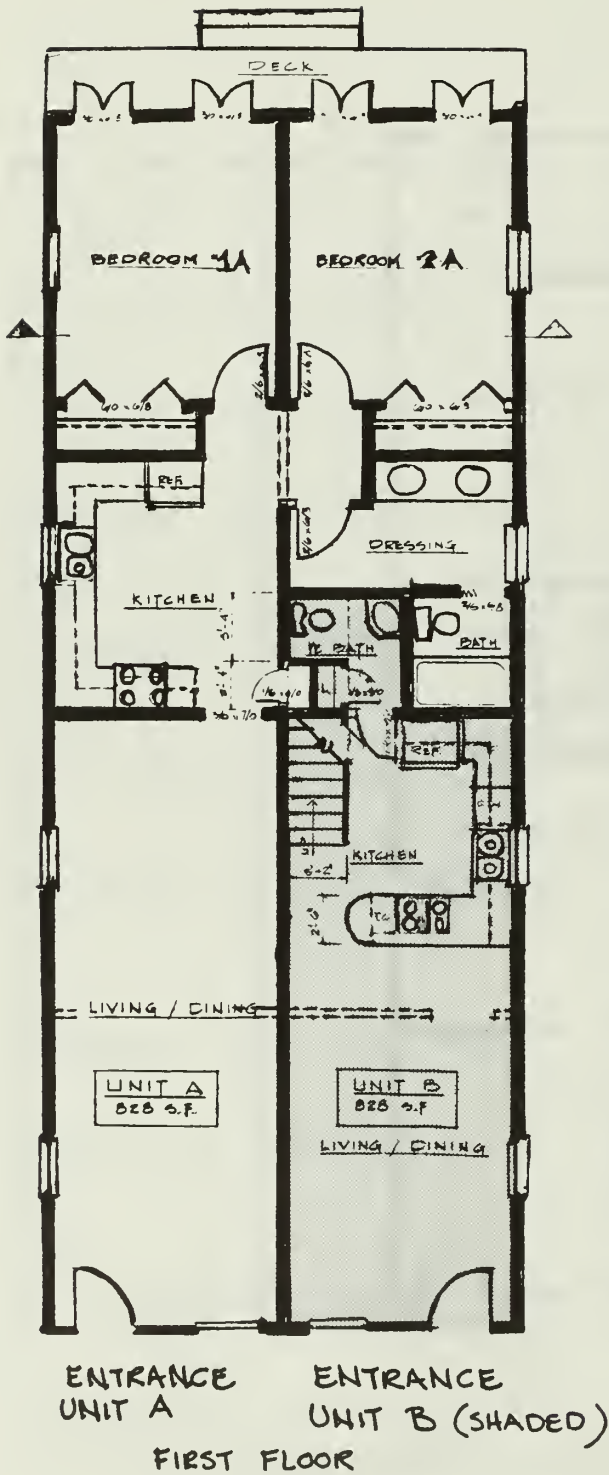

6a and 6b. After rehabilitation floor plan of 1890 building. The unit on the left now extends across the full width of the building in the rear half. To regain the floor space thus lost in the right unit, a stair was added, further altering the plan of this simple structure.

Interpreting
the Secretary of the Interior's
Standards for Rehabilitation

Number: 87-083

- Applicable Standards:
- 2. Retention of Distinguishing Architectural Character (conformance)
 - 9. Compatible Design for New Additions (conformance)

Subject: ROOFTOP ADDITIONS

Issue: Rooftop additions are often proposed when there is a need for additional space in a historic building which is located in an urban area where ground floor expansion is not a possibility. There is no specific "formula" for determining when a roof-top addition may be appropriate; because each historic building and its setting/context is unique, each proposal must be reviewed individually. While it is generally true that smaller buildings, three stories or less, are least suitable for new additions, and that taller buildings may be more likely to lend themselves to a new rooftop addition, there are still notable exceptions. And, it is important to realize that some historic buildings cannot accept rooftop additions at all. A building with a very distinctive cornice, for example, even though eight or nine stories tall, may be just as unsuitable as a smaller building for a rooftop addition, if such an addition would be likely to obscure that character-defining feature. Standard 9 does not discourage rooftop additions if they do not destroy significant historic or architectural fabric, and if their design is compatible in size, scale, color, material and character of the property and the neighborhood. The guidelines recommend that all new additions to historic buildings be designed so it is clear what is new and what is historic, and that rooftop additions in particular be as inconspicuous as possible when viewed from the street, and that generally they be set back from the wall plane.

Application: A rooftop addition was proposed for a four story apartment building that was being rehabilitated for continued residential use. The building (actually two buildings either built together or designed and built to complement each other) was constructed in 1914 in a rather plain, vaguely classical revival style of brick with a slightly raised limestone base, beltcourses and some decoratively carved keystones on the first floor. It is capped by a simple but fairly prominent dentilled cornice (see illus. 1). This building is one of several larger scale apartment buildings located in a primarily small scale, single family residential neighborhood. The building itself is surrounded on both sides and across the street by two to two and one half story rowhouses, and therefore is highly visible within the district. For this reason alone, it might appear that the addition of any more height to this building would not meet the Standards.

87-083

However, using a setback design concept linked to the cornice by a sharply slanted pent roof, another floor was added that is only minimally visible on the non-significant side elevations, and cannot be seen from the other side of the street directly across from the building (see illus. 1). The new rooftop addition and stairtower (see illus. 2-3) is visible only on the non-significant and non-character-defining north and south elevations of the building. The fact that there are skylights inserted into the new pent roof is also unknown to passersby. From the public wayfare the new addition is visible only on the non-significant side elevations in the new brickwork rising above the original roofline, and the stairtower. This rooftop addition thus preserves the historic character of this building, and is in conformance with the Standards.

Prepared by: Anne Grimmer, TPS

These bulletins are issued to explain preservation project decisions made by the U.S. Department of the Interior. The resulting determinations, based on the Secretary of the Interior's Standards for Rehabilitation, are not necessarily applicable beyond the unique facts and circumstances of each particular case.



1. This early twentieth century apartment building was actually constructed as two buildings of harmonious but slightly different design.



2. New rooftop addition and stairtower visible on the south elevation.



3. New rooftop addition visible on the north elevation.

Interpreting the Secretary of the Interior's Standards for Rehabilitation

Number: 87-084

- Applicable Standards:
2. Retention of Distinguishing Architectural Character
 5. Sensitive Treatment of Distinctive Features and Craftsmanship
 6. Repair/Replacement of Deteriorated or Missing Features

Subject: SUBDIVISION OF SIGNIFICANT SPACES

Issue: The imposing lobbies, auditoriums and other grand spaces associated with hotels, churches, theaters and other public buildings are typically character-defining features of such structures. These major spaces, however, are often part of a spatial sequence that has been consciously designed as part of the overall plan of the building. Other, adjacent spaces, either leading up to the building's "centerpiece" or flowing from it, may thus be essential components of the overall character of the structure. Any rehabilitation of such structures must respect the procession of these congruent spaces. Isolating them from their context within the overall organization of the building may cause a project to violate the Secretary of the Interior's "Standards for Rehabilitation."

Application: A large building constructed in 1925 as a social and residential club for a fraternal organization, and subsequently converted to a hotel, a drug rehabilitation center and other uses, was rehabilitated as residential apartments. The primary entrance to the building was a three-story lobby that was the most prominent and most highly ornamented interior space (see illus. 1). At one end of the lobby was a monumental split stair leading to a gallery and to two other large public spaces, a lounge area known as the "palm room" and a dining room (see illus. 2, 3 and 4). Photographs of the lobby demonstrate that the palm room was continuous with that space. The palm room was clearly visible through the reredos, and shared the lobby's deeply coffered ceiling. The large pendant light fixture in the lobby was balanced by an identical element in the palm room. The palm room and the lobby, and to a lesser extent the dining room (which opened onto the palm room) were thus perceived as components of one large space.

In the rehabilitation, both the palm room and the dining room were subdivided and incorporated into apartments. The palm room was stripped of its decorative features and an additional floor was introduced into the space. In the dining room the ceiling beams and brackets, panelled wall with niche, hooded fireplace, and other features were retained, but incorporated into individual apartments (see illus. 5). To enclose the new apartment spaces, a floor-to-ceiling partition was constructed behind the ornamental screen between the lobby and the palm room (see illus. 6).

The project was determined not to meet the "Standards for Rehabilitation" on a number of grounds. In the palm room both the decorative finishes and the space itself were destroyed in the process of inserting two levels of residential space. In the dining room, individual features were retained, but in the finished work they appear as individual artifacts only, out of architectural context. The sense of the room as a coherently organized space is lost. These modifications to the two spaces had adverse effects on the historic character of the building, and alone would preclude the project from meeting the Secretary's Standards. When these spaces are viewed in relation to the overall layout of the building, however, the consequences caused by their subdivision appear even more serious.

The insertion of a solid partition behind the open screen effectively cut off the lobby from the palm room. The damage wrought by the rehabilitation to the individual spaces thus exceeded the demolition of individual features or their incorporation into smaller rooms. The rehabilitation destroyed the formal organization of the spaces themselves. The progression from the grand, three-story lobby, up the elaborate split stair into the palm room and adjoining dining room was lost, and the historic character of the building irreparably harmed.

Prepared by: Michael Auer, TPS

These bulletiins are issued to explain preservation project decisions made by the U.S. Department of the Interior. The resulting determinations, based on the Secretary of the Interior's Standards for Rehabilitation, are not necessarily applicable beyond the unique facts and circumstances of each particular case.



1. Lobby before rehabilitation. Ornamental screen at top of stairs leads to two other formal open spaces, the palm room and the dining room.

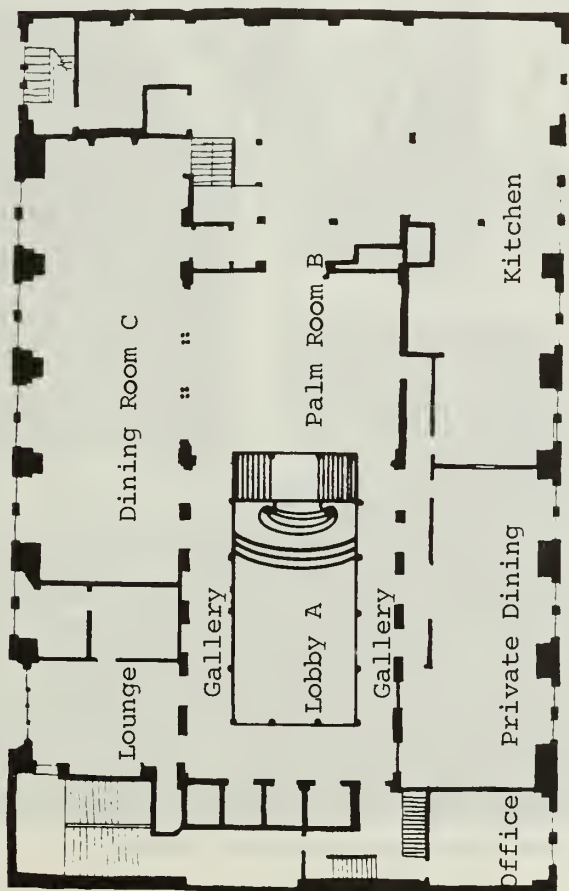

2. Plan of lobby (A), adjoining palm room (B) and dining room (C) before rehabilitation.

87-084

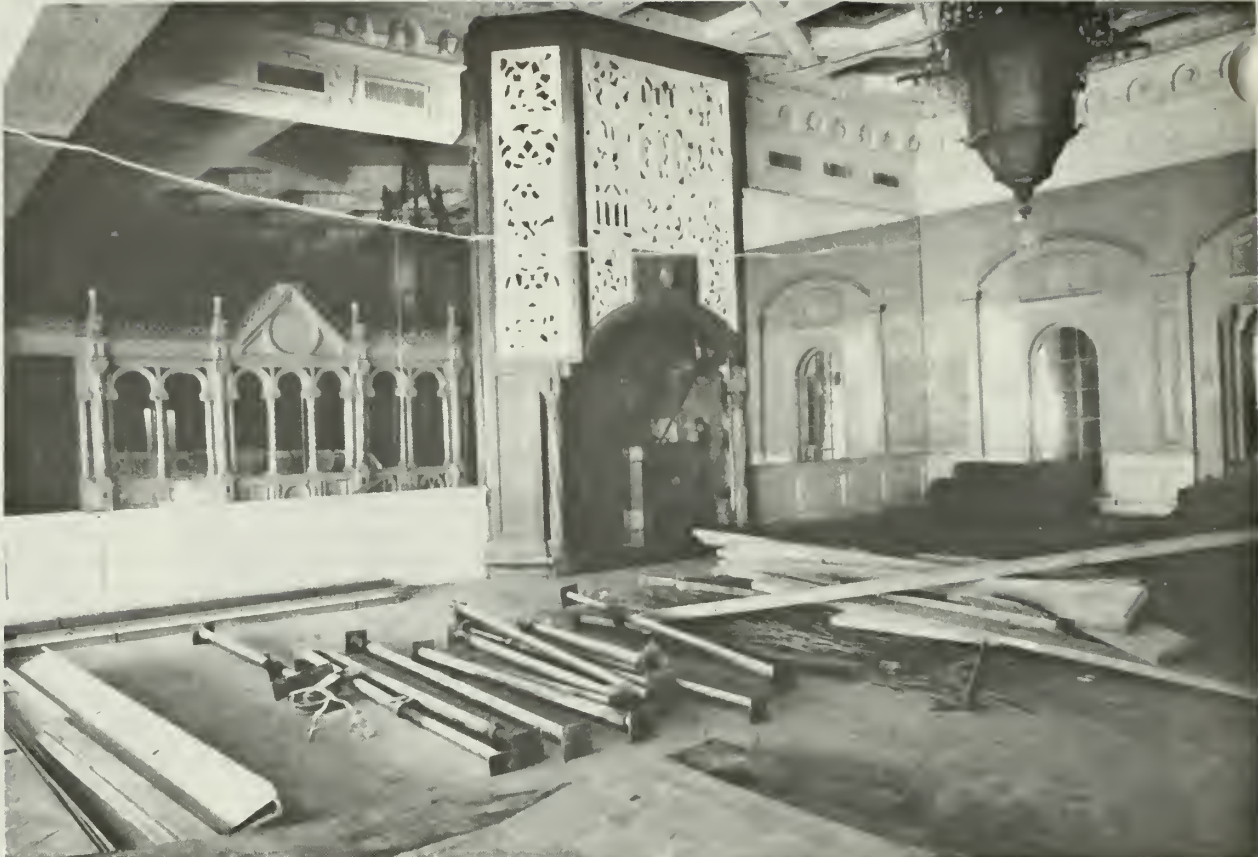

3. Palm court beyond lobby stair. Ornamental screen between the lobby and this room is reflected in mirrored wall at the left of the fireplace. All features were removed from this room in the rehabilitation.



4. Dining room, before rehabilitation, and adjoining palm room (right).

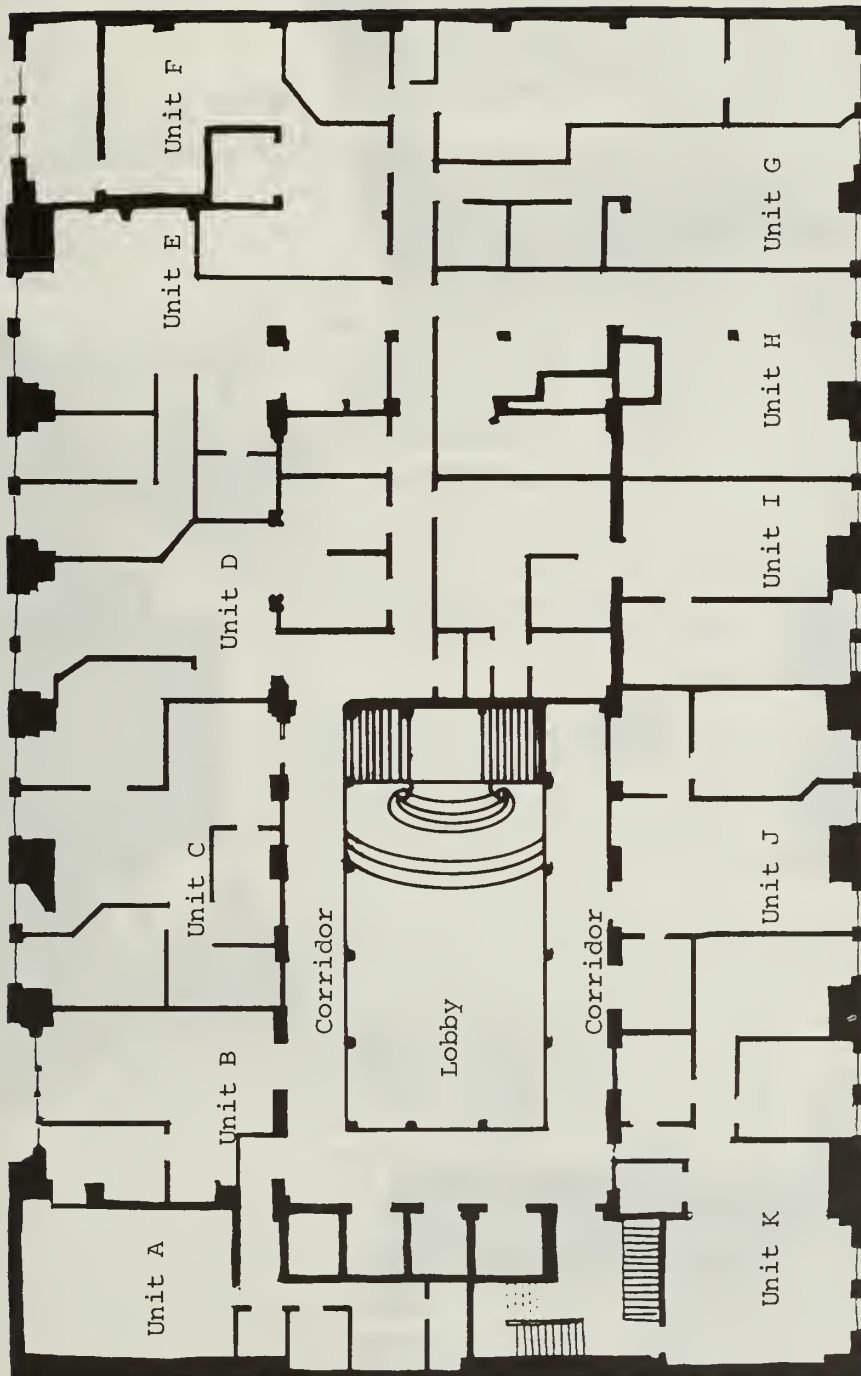

5. Lobby and adjoining spaces after rehabilitation. The palm room and dining room have been subdivided. A new partition directly behind the decorative screen has destroyed the progression of spaces that marked the original design.

87-084

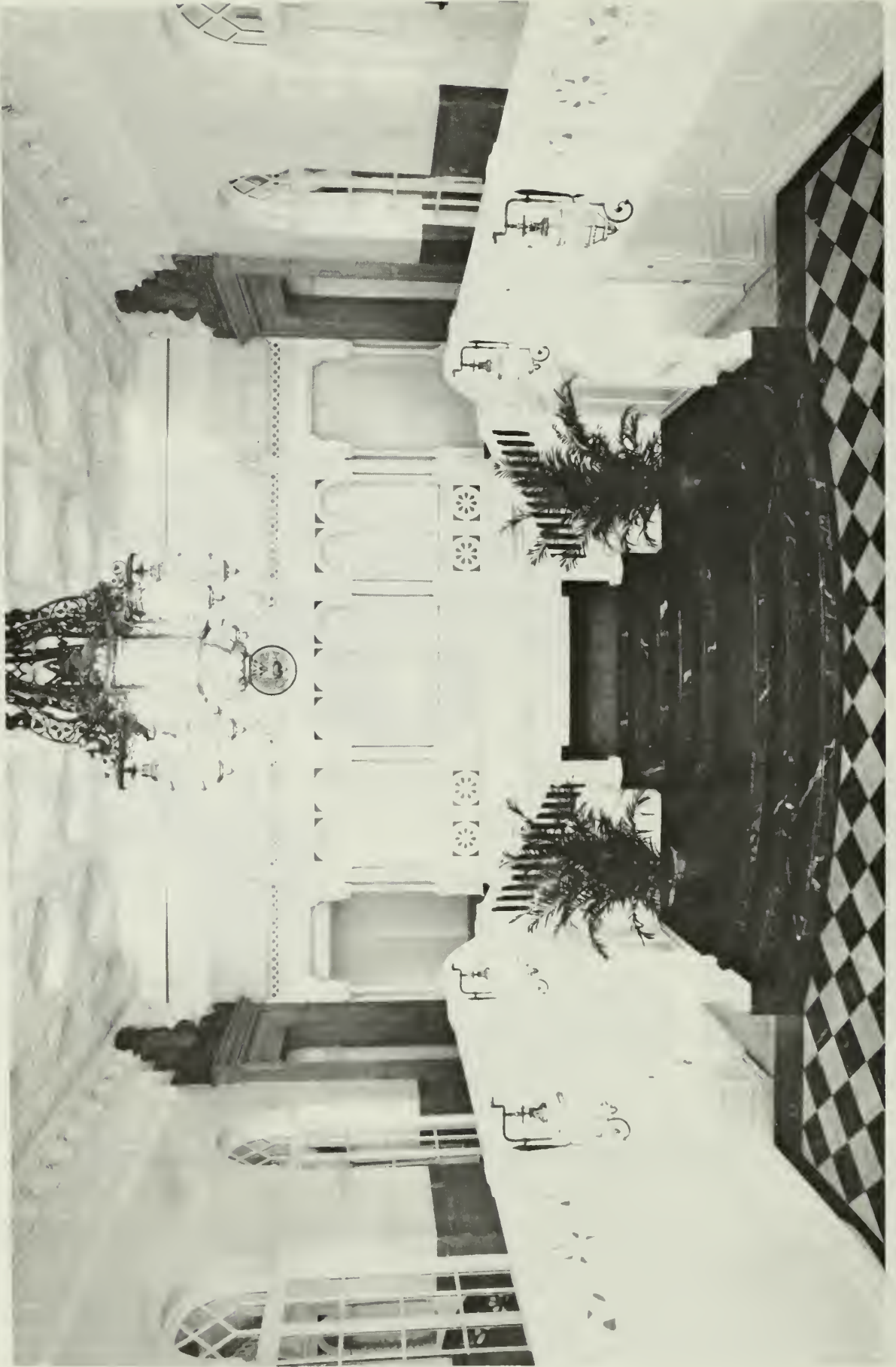

6. Lobby after rehabilitation. Partition behind screen closes off palm room and dining

Interpreting the Secretary of the Interior's Standards for Rehabilitation

Number: 87-085

- Applicable Standards:
3. Recognition of Historic Period (nonconformance)
 9. Compatible Contemporary Design for new Alterations/Additions (nonconformance)

Subject: INCOMPATIBLE NEW ADDITIONS

Issue: Entrances and porches are often the focus of historic buildings, particularly if they occur on primary elevations. When rehabilitating historic buildings, if an entrance or porch is not original and has not acquired significance, property owners and architects are free to remove these features and/or replace them. Design and construction of new entrances or porch additions, however, must be compatible in size, scale, color, material, and character with the historic building, neighborhood, or environment. The new construction should not dominate, but be clearly differentiated from, the historic building; and according to Standard 3, it should not seek to create a false historic appearance.

Application: An 1880 manufacturing facility at the edge of a registered historic district was rehabilitated into a retail store (see illus. 1). The original brick building was a simply detailed, two-storied, gabled structure, with a large one-story section to the rear. It displayed characteristics typical of its function as an industrial building, with large door openings, numerous windows, and a covered loading dock.

The rehabilitation called for the removal of a ca. 1950 corrugated metal roof covering the loading dock, and the construction of a new porch or portico in its place on the south side of the building. While the existing roof was a simple addition to the original building, it was generally consistent with the industrial character of the building, and could have been retained (see illus. 2). However, in the rehabilitation, a decision was made to construct a new porch on this highly visible side elevation, making it the new primary entrance from a parking lot. The new construction was determined not to meet Standards 3 and 9.

The new porch, which retained and boxed in the surviving pipe columns from the old roof, is located in the same general location as that roof (see illus. 3). However, it differs from the old in design and scale. It has larger columns and is three feet taller, thereby dominating the south side and front of the building. The new portico fails to meet Standard 9, in that its size and scale are out of proportion to the historic building. The new portico also departs from the industrial character of the building. With its deep entablature and massive formal columns, the new portico creates more monumental, classical architecture than is consistent with the function and historic character of this modest industrial building. The new portico hints of the Greek Revival, an architectural phenomenon much earlier than the date when this building was constructed.

87-085

The rehabilitation could have met the Standards if one of the following options had been chosen: 1) retention of the existing side roof, 2) removal of the roof, leaving the south wall as it was originally, or 3) construction of a simple new roof, following the size and pitch of the old roof.

Prepared by: Camille M. Martone, TPS

These bulletins are issued to explain preservation project decisions made by the U.S. Department of the Interior. The resulting determinations, based on the Secretary of the Interior's Standards for Rehabilitation, are not necessarily applicable beyond the unique facts and circumstances of each particular case.



1. Front elevation of the 1880 manufacturing facility as it appeared prior to the rehabilitation.



2. South side elevation of the building with roof-covered loading dock prior to rehabilitation.



3. Photograph of building after rehabilitation with construction of portico.

Interpreting the Secretary of the Interior's Standards for Rehabilitation

Number: 87-086

Applicable Standards: 6. Repair/Replacement of Deteriorated or Missing Architectural Features Based on Historical Evidence

Subject: MATCHING THE HISTORIC WINDOW DESIGN AND DETAIL WHEN REPLACEMENT IS NECESSARY

Issue: A window survey can be a valuable component of rehabilitation project planning, particularly for buildings of institutional scale. An objective window survey by an experienced person will establish the condition, and repair or replacement needs of the existing windows. A critical aspect of the survey--often overlooked--is using it to help identify the visual role that the historic window design and its detailing or craftsmanship plays in defining the character of the structure. Such an evaluation should include the size and number of historic windows in relationship to the wall surface, the pattern of repetition, overall design and detail, proximity to the ground level and key entrances, and their visibility, particularly on primary elevations--both from a distance and up close. It should also consider whether significant interior spaces exist in which the windows are distinctive features. If extensive deterioration makes it necessary to replace the historic windows--especially those that have distinctive muntin patterns or decorative detailing--the replacement windows should provide a close visual match of the design, detail, and finish. Using the same type of material is always a preferred preservation recommendation to achieve a visual match particularly when the windows are seen at close range and when they are important in defining the building's historic character. If the replacement windows selected do not adequately match the historic configuration and result in changing the appearance of the resource, Standard 6 will be violated.

Application: A school building that remained as a single component of a previous multi-structure complex for the handicapped was being rehabilitated for office use. When viewed from a distance across the former campus (see illus. 1), the masonry school building is identified by its twin entrance towers, steeply pitched gable and hip roof, and round-arched entrances on its primary facade. When viewed closer, as one would see the primary south elevation when approaching either of the entrances, the windows become distinctive features of the building because of their size, number, pane configuration, and high visibility in proximity to the walkway and main entrance (see illus. 2 and 3). Finally, from the inside (see illus. 4), the historic windows have distinctive muntin detailing, shadow lines, and finishes.

An important aspect of the application was inclusion of a comprehensive window survey. Based on the survey, the applicant contended that total window replacement was necessary. NPS agreed that the windows were deteriorated to the point that total replacement was appropriate. Once that issue was resolved, the main question remaining in review was to determine whether the owner had selected a replacement

window that was consistent with the building's historic character. The owner's first option was a wood replacement unit, but an aluminum replacement unit with sandwiched muntins was instead selected based on a combination of factors such as faster delivery time, meeting energy code requirements without having to install storm windows or interior energy panels, and the lower cost of the window units themselves. In making an overall decision as to whether the project could be certified, NPS concluded that the design of the replacement units was not consistent with the building's historic character. As part of the denial letter, NPS wrote:

Regarding the windows, on the basis of the window survey, I accept that replacement of the twelve-over-one is warranted; however, I find that aluminum replacement windows with sandwiched muntins are quite inconsistent with the character of this structure. The twelve-over-one windows are an integral component of the external architectural design of the building, and preservation of their visual qualities is not dispensable. Although you have attempted to match the pane configuration, the muntins themselves are flat; the change in appearance of the windows as a result of these sandwiched muntins between double glazing fails Standard 6, which requires "in the event replacement is necessary, the new material should match the material being replaced in composition, design, color, texture, and other visual qualities."

In rejecting the design of the proposed replacement units, NPS gave the owner an alternate course of action to bring this aspect of the project into conformance with the Standards. This was to select a commercially available wood replacement window that would match the historic design and have true divided single-glazed panes rather than applied exterior muntins. Finally, if an energy panel was desired, this commercially-available feature could be applied inside the sash or, alternatively, a standard interior storm window could be used. Such a window system would preserve the detailing of the historic windows and the historic appearance of the windows would be retained not only from a distance--but equally important in this case--from up close.

Prepared by: Kay D. Weeks

These bulletins are issued to explain preservation project decisions made by the U.S. Department of the Interior. The resulting determinations, based on the Secretary of the Interior's Standards for Rehabilitation, are not necessarily applicable beyond the unique facts and circumstances of each particular case.



1. The former school building is characterized by its distinctive form--massive yet only three stories in height--its twin towers, unusual arch-shaped entrance and series of large-scale, twelve-over one windows that were designed to provide maximum daylight in the classrooms.

87-086



2. and 3. The windows and window openings as one would see them close to the building's walkway entrance establish the importance of their design and detail.

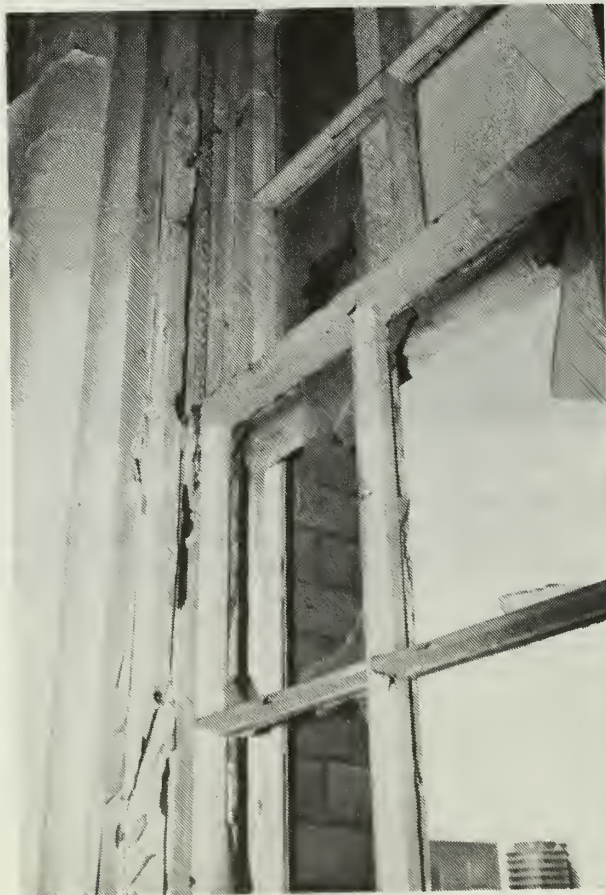

4. From inside as well, the detail, design features, shadow lines and finishes are all part of the character of the window. If a historic window is so deteriorated that it needs to be replaced, a matching replacement window is the most appropriate choice to meet the Secretary's Standards within a rehabilitation project.

Interpreting the Secretary of the Interior's Standards for Rehabilitation

Number: 87-087

Applicable Standard: 6. Repair/Replacement of Deteriorated or Missing Architectural Features Based on Historical Evidence (nonconformance)

Subject: INAPPROPRIATE REPLACEMENT WINDOWS

Issue: Inappropriate replacement windows can easily detract from the historic appearance of an entire building and change its historic character. The National Park Service requires an applicant to show that repair cannot be accomplished and that replacement is necessary due to an extensive level of deterioration. Once this determination has been made through proper planning, any replacement window needs to match the historic sash, the pane size and configuration, the glazing, the muntin detailing and profile, and the historic color and trim. This is true whether the window is a simple one-over-one, double-hung unit, or a double-hung sash with multi-light division. Also, whether the replacement is made of wood or aluminum, special custom work is nearly always required to achieve a satisfactory match. If the principal design features differ from the historic window, it is likely the new windows will violate Standard 6 and, in consequence, project certification will be jeopardized.

Application: One of the larger commercial buildings in a district of intact 19th century structures was being rehabilitated for office use. Built in three sections and unified with a handsome Italianate facade in about 1875, the entire structure occupies the intersection of two major streets on the front, and extends the length of one city block at the rear. As part of the application process, a request was made by the owner to install replacement windows because of the deteriorated condition of the original windows. NPS responded affirmatively by letter stating that replacement in kind of the historic sash was acceptable. NPS would further permit the owner to use aluminum window units but, in this case, imposed a set of special conditions that had to be met for approval. The NPS letter to the owner said:

...On any facade where wholesale replacement is necessary, aluminum double-glazed replacements will be acceptable provided: 1. they are custom built to match the size and shape of the existing window; 2. all glazing is clear; 3. the pane sizes and configuration exactly match the originals; 4. all false muntins are exterior applied and closely match the originals in profile; and 5. all interior and exterior wood window trim is repaired or replaced to match...

After work was completed by the owner on the building, the project application was reviewed again by NPS for conformance to the special conditions. NPS denied final certification, in large measure, for the inappropriately designed replacement units installed. The different material (aluminum rather than wood) was not an issue in this particular case. NPS wrote: "After lengthy negotiations over the issue of window

replacement, we approved the removal of the historic windows and established parameters for the design of the new windows. These parameters were not met, and the new windows detract from the historic character of all three public facades of the structure...This is particularly unfortunate in light of your arguments that they would preserve the historic appearance better than storm sash over the existing units."

Before and after photographs revealed several design deficiencies in the new window. Where one over one double-hung windows had existed historically on the building's primary facade, the replacement windows were a "fixed" design with both upper and lower sash on the same plane; the horizontal piece applied as a meeting rail is actually flat, and consequently unable to cast the familiar shadow line of the historic window. Finally, there was a dramatic difference in color, from a light cream color to dark brown (see illus. 1 and 2). On another key facade, where there had been historic four-over-four double-hung windows, fixed sash were installed, the light divisions were altered, wider muntins were used, and the color of the windows was changed (see illus. 3, 4 and 5).

After NPS denial, the applicant sought to bring the replacement windows into conformance by a series of cosmetic changes, including relocating the horizontal muntin at the top of the four-over-four window, and applying wood trim to the aluminum muntins in an attempt to create a thinner appearance (see illus. 6 and 7). This proposal was also rejected by NPS on appeal. In a final letter to the owner, the Chief Appeals Officer explained:

In view of the prominence of these windows, I do not believe that any superficial, cosmetic changes to the muntins--instead of replacing the existing sash and installing accurate replicas of the originals--can be made that would bring the project into compliance.

Prepared by: Kay D. Weeks, TPS

These bulletins are issued to explain preservation project decisions made by the U.S. Department of the Interior. The resulting determinations, based on the Secretary of the Interior's Standards for Rehabilitation, are not necessarily applicable beyond the unique facts and circumstances of each particular case.

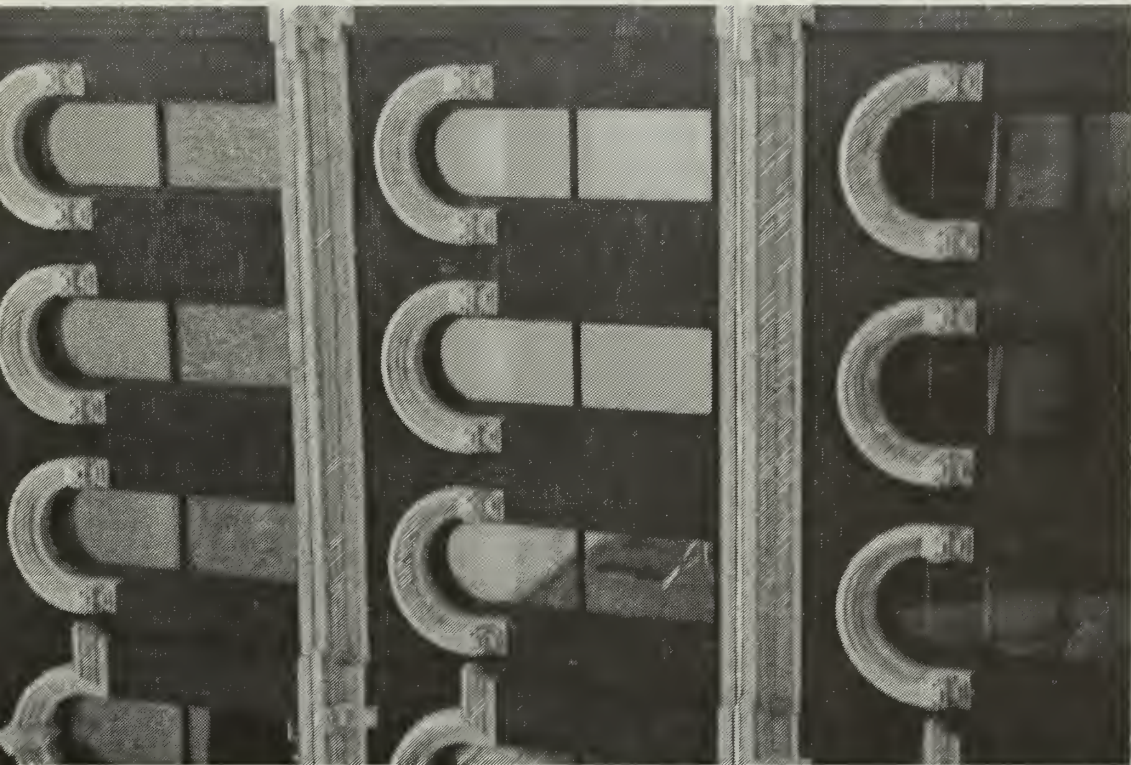

2. After rehabilitation and installation of the new windows, the "eyebrows" seem to float--disconnected--above the dark brown fixed sash.

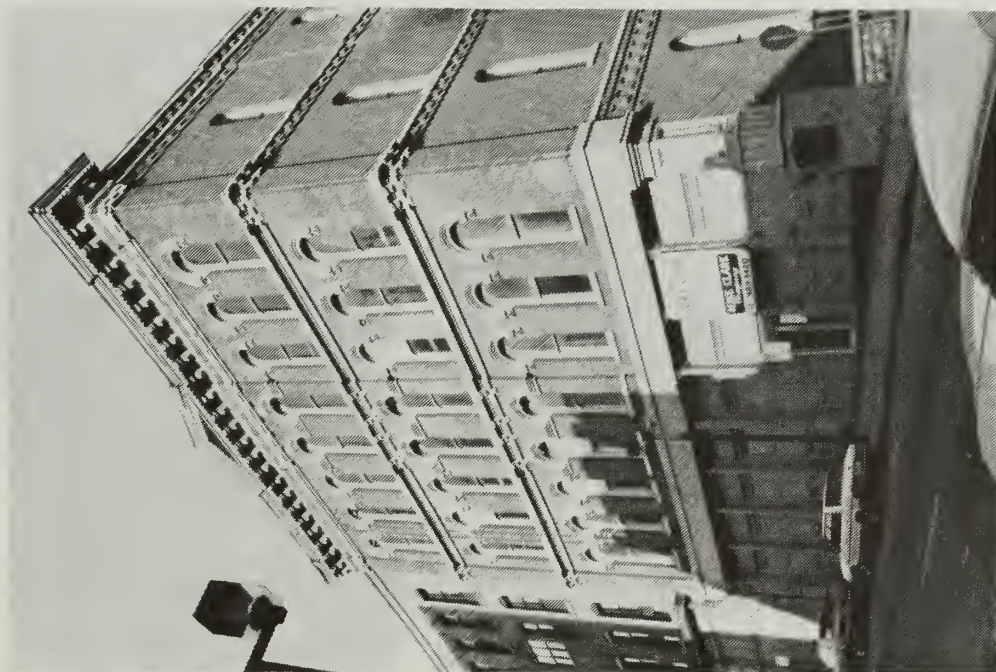

1. Before rehabilitation, the front elevation of the 1875 commercial building is shown with its distinctive "eyebrow" ornamentation framing the one-over-one, circle-top, double hung windows. Because the sash and eyebrows are all painted a light color, they are perceived historically as a unified design component.



3. Before rehabilitation, the windows on another street elevation were four-over-four units that feature delicate, attenuated muntins. The historic window is a double-hung design; the shadow line that the meeting rail casts at the center of the two-part window is a distinctive quality.

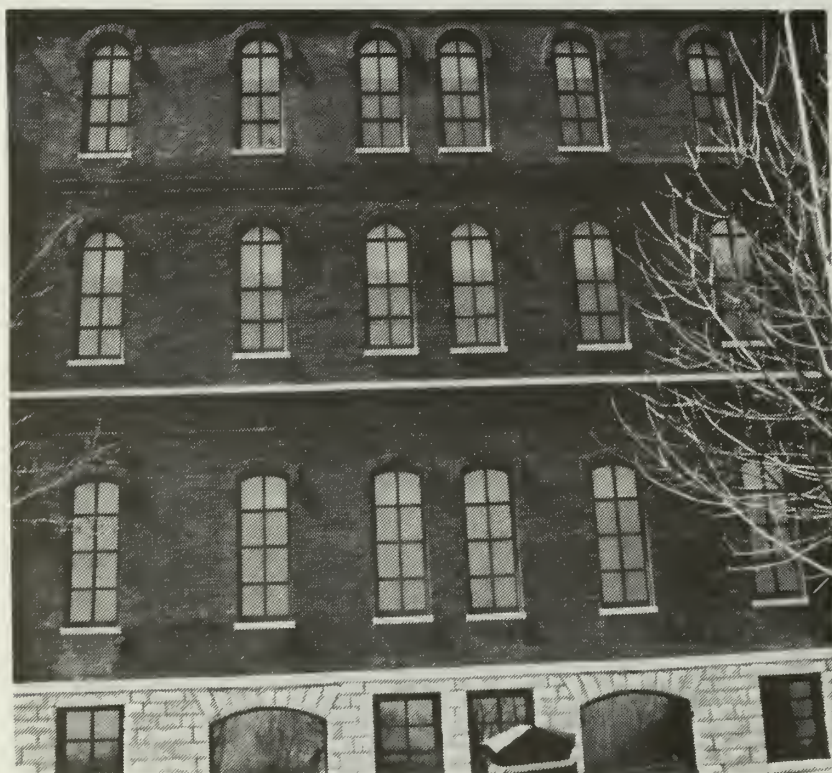

4 and 5. After rehabilitation, there is a striking change in the appearance of the entire facade due to the installation of inappropriate replacement windows. In addition to the obvious color disparity, the unit is noticeably on one plane rather than double-hung. The muntins are also much heavier and there is no meeting rail.

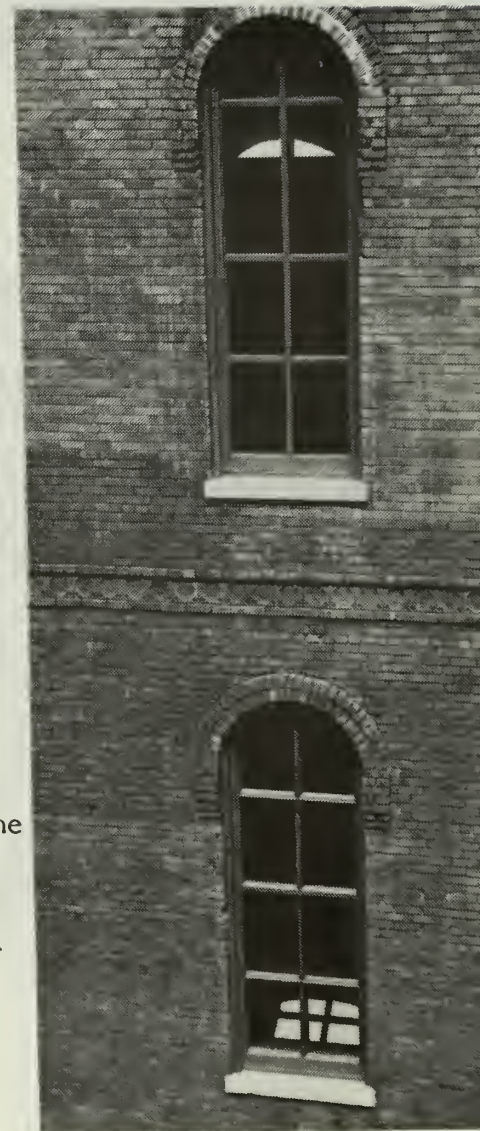

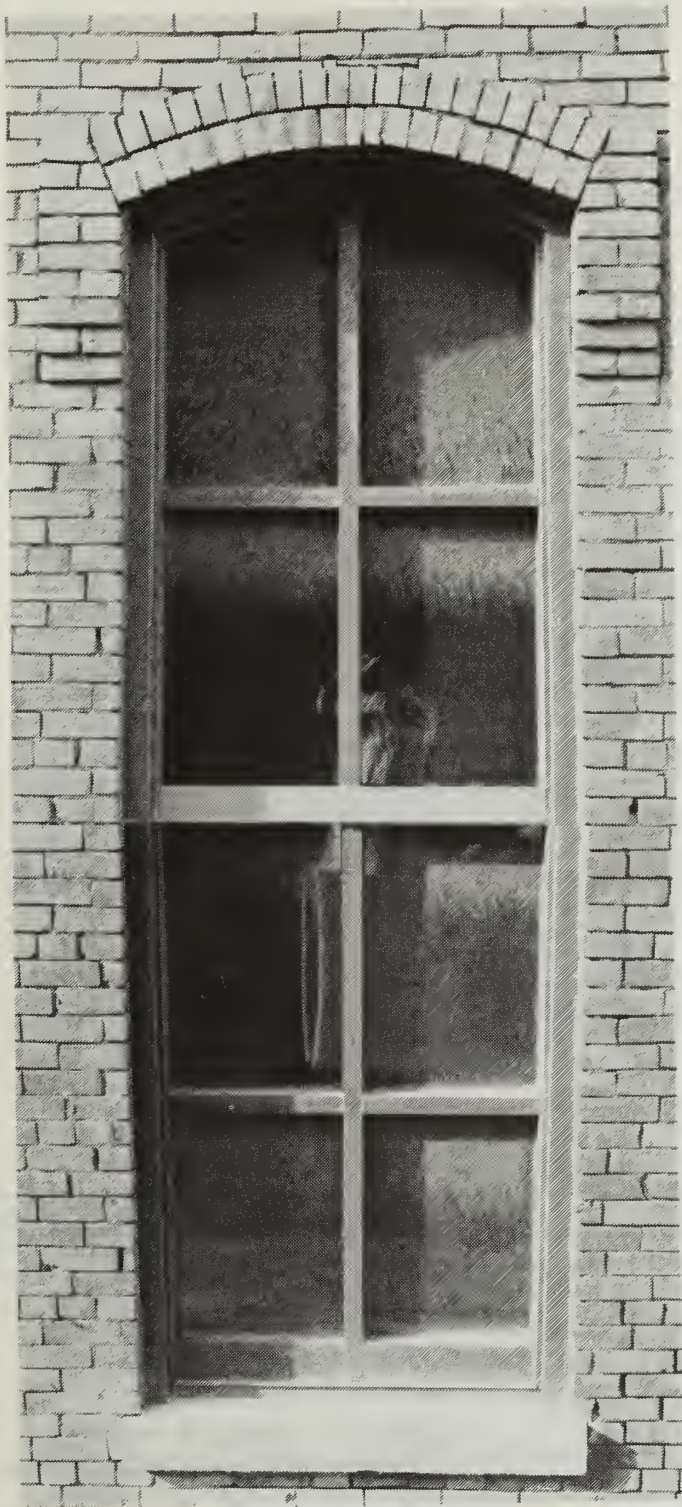

PROPOSED TREATMENT FOR "MEETING RAIL"

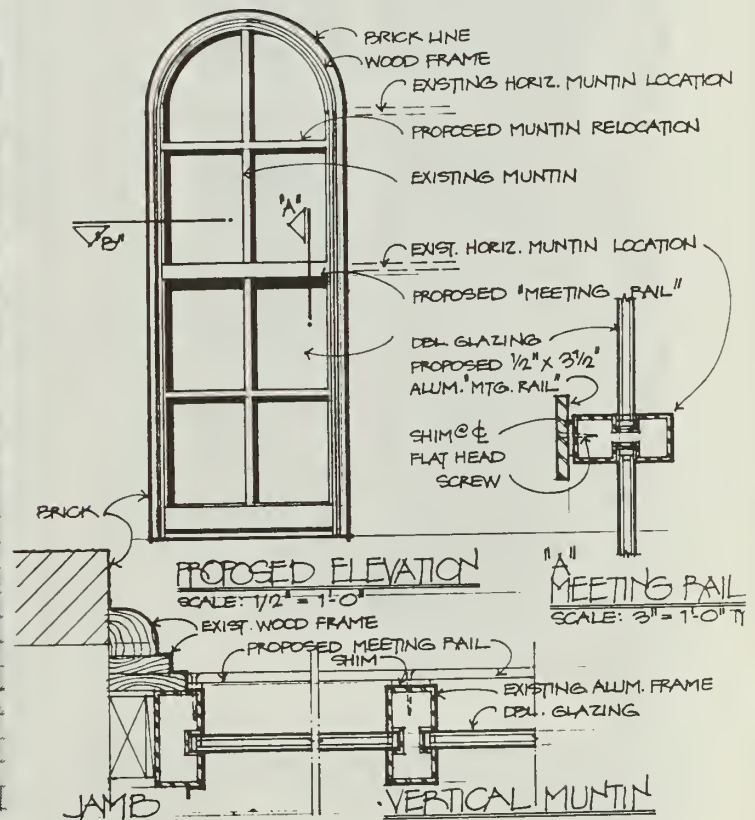

6. In an attempt to bring the inappropriate four-over-four replacement units (see 4 and 5.) into conformance with the Standards, two alternatives were proposed. In proposal A, the horizontal muntin at the top would be relocated so that all eight lights would be of equal size like the original. A 3 1/2" wide aluminum strip would be applied in an attempt to recapture some aspects of the meeting rail. Even after these adjustments, however, the upper and lower sash would read as a single, fixed unit; the muntins are also too wide and too flat.

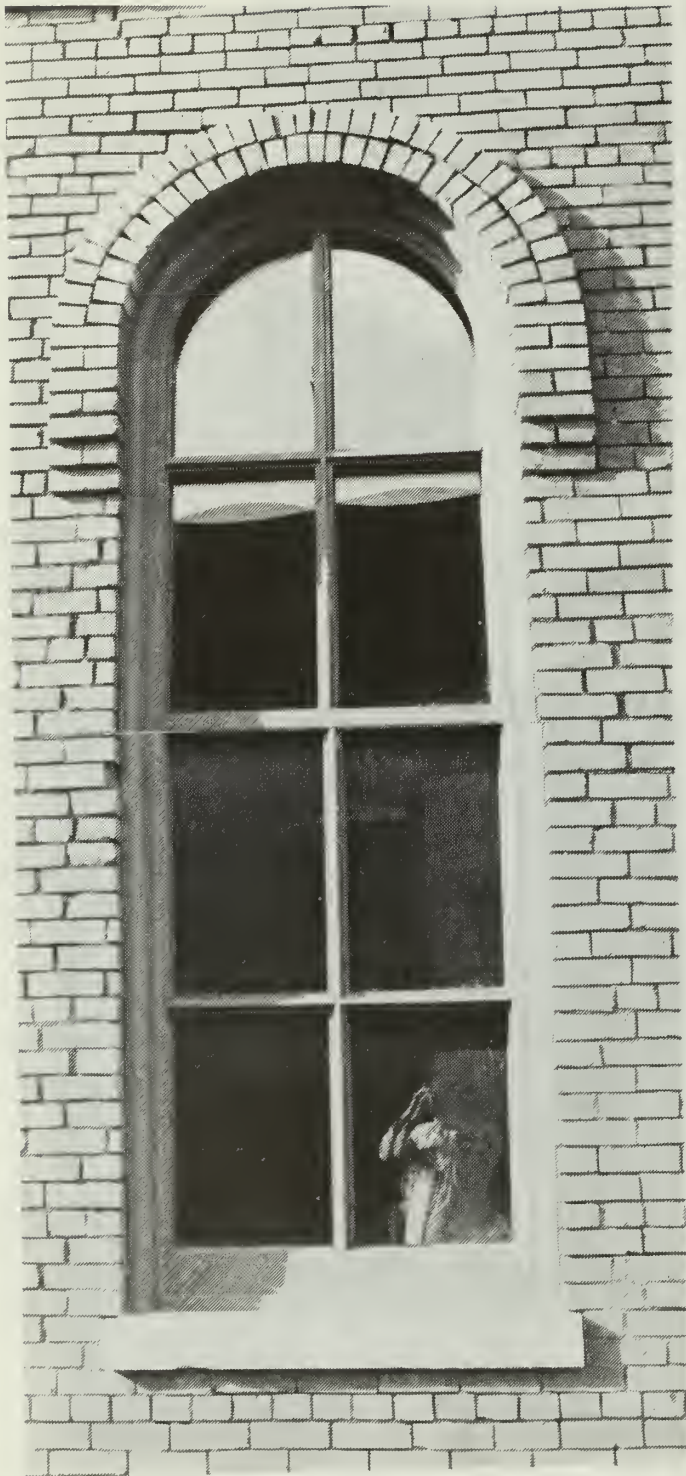

REMOVE TOP HORIZONTAL MUNTIN & GLASS

RESTRUCTURE WINDOW SO TOP HORIZONTAL MUNTIN IS 1/2 MIDWAY BETWEEN TOP SASH SECTION

PAINT EXISTING ALUMINUM MUNTINS CHARCOAL (MID VALUE); GREY ARCHITECT WILL SUBMIT COLOR CHIP

APPLY WOOD TRIM SECTION TO PAINTED MUNTINS

APPLY 3/4" THICK x FULL WIDTH (OF EXISTING SECTION) WOOD SECTIONS TO HORIZONTAL & VERTICAL PERIMETER SECTIONS & TO HORIZONTAL MEETING PAUL COLOR TO BE BRONZE

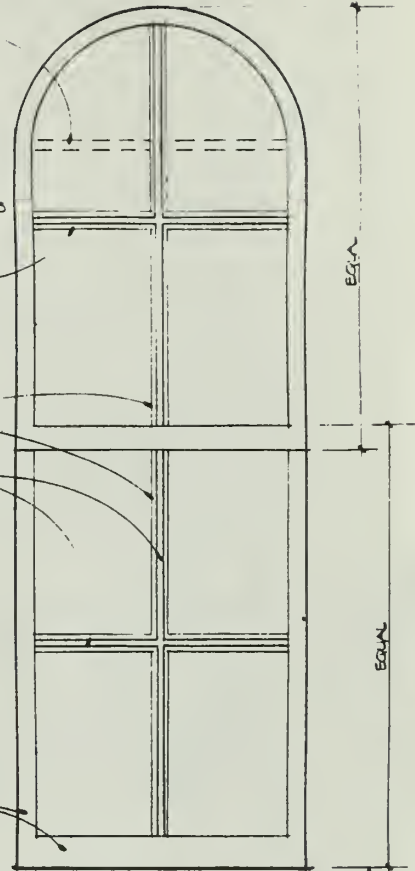

FRAME ELEVATION

3/4" = 1'-0"

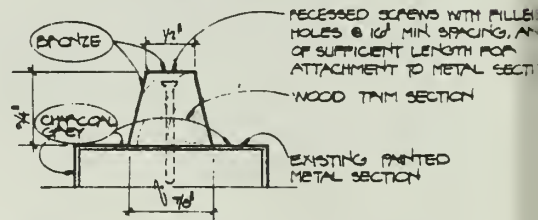

WOOD TRIM DETAIL

FULL SIZE

○ INDICATES PAINT COLORS

7. In alternative B, proposed changes included installation of a wood brick molding. In an attempt to make the muntin appear thinner and visually recessed, the wide aluminum muntins would be painted a charcoal gray; trapezoidal shaped wood strips would also be applied to the existing flat muntin and painted to match the existing window color. Even making these modifications, the replacement window did not match the detailing of the historic window--the depth of the frame and muntin was still far too shallow, and the muntin profile and width was still inappropriate. This proposal was also rejected.

Interpreting the Secretary of the Interior's Standards for Rehabilitation

Number: 87-088

Applicable Standard: 6. Repair/Replacement of Deteriorated or Missing Architectural Features Based on Historical Evidence (conformance)

Subject: RESIDENTIAL AND OTHER SMALL-SCALE BUILDINGS - REPLACEMENT WINDOWS

Issue: If a determination has been made that the historic windows cannot reasonably be repaired due to an extensive level of deterioration, a replacement window needs to be selected with care in order to preserve the historic character of the building. Any replacement window should match the historic sash, pane size and configuration, glazing, muntin detailing and profile, and historic color and trim. This is particularly important where small, residential buildings are concerned and the windows are highly visible due to their proximity to the sidewalks and streets. Using the same material is always the preferred preservation option to achieve a satisfactory match; and in some cases with small buildings it may be the only possible way. Special custom work is frequently required. If an inappropriate window is selected, it is usually difficult to make post-installation design and detailing adjustments to the new window in an effort to bring the window into conformance with the Standards.

Application: Three workers' rowhouses were rehabilitated into subsidized family housing (see illus. 1). The buildings are simple in character and distinguished only by a corbelled cornice on the facades and large wood windows with 2/2 sash on all elevations (see illus. 2). The historic structures are situated in particularly close proximity to the street, and consequently their facades are highly visible.

In the course of the rehabilitation, all the historic wood window sash, which were deteriorated and not salvageable, were replaced. The replacement windows installed consisted of a single-hung aluminum window with fixed upper sash and a screen panel placed directly below the upper sash in the same plane, a meeting rail considerably wider than the original, muntins sandwiched between the glass, and a bronze colored finish (see illus. 3). These windows were determined not to meet Standard 6 in that they did not match the existing windows in design, color, profile, and muntin configuration.

The 2/2 wood windows, with truly divided window lights, were an integral part of the design of these small and simple buildings. The new aluminum windows fail to respect the character and the visual qualities of the original windows. The screen panel directly below the upper sash altered the double-hung appearance of the original windows, and the stile and rail profiles along with the sandwiched muntins did not adequately duplicate the size and form of the original windows.

A new proposal to modify the appearance of the aluminum windows was subsequently submitted in an attempt to more closely approximate the visual qualities of the original windows. A specially shaped exterior frame with a thin muntin would be

milled of wood and applied over the existing flush metal sections of the new aluminum windows (see illus. 4). However, it was determined that this modification did not capture the historic appearance of the existing wood windows. Wood frames fabricated with central dividing muntins and applied to each window would not faithfully duplicate the configuration of the old windows and would read as a temporary treatment, rather than an integral component of the sash. In view of the proximity and visibility of these windows to the street, any superficial or cosmetic change to the existing replacement sash, regardless of material, would not be consistent with the historic character of this building.

To bring this rehabilitation into conformance with the Standards, the owner decided to replace the new aluminum windows, which were clearly visible from the street, with new wood sash duplicating the originals in size, profile, muntin configuration, and composition (see illus. 5 and 6). With the new wooden sash in place, the project was subsequently certified.

Prepared by: Camille M. Martone, TPS

These bulletins are issued to explain preservation project decisions made by the U.S. Department of the Interior. The resulting determinations, based on the Secretary of the Interior's Standards for Rehabilitation, are not necessarily applicable beyond the unique facts and circumstances of each particular case.



1. Pre-rehabilitation photograph of workers' rowhouses (front elevation).



2. Pre-rehabilitation photograph of historic two-over-two double-hung windows that had a thin vertical muntin and wooden molding (brick molding) around the frame.



3. Post-rehabilitation photograph of aluminum replacement window. The vertical muntin was sandwiched within the insulating glass and the double-hung appearance changed since the screen panel was installed directly below the fixed upper sash.



4. Aluminum replacement window with a wood mock-up of an applied unglazed sash frame and muntin placed over the upper aluminum sash. The applied frame and muntin look like temporary add-ons, rather than matching the historic sash.

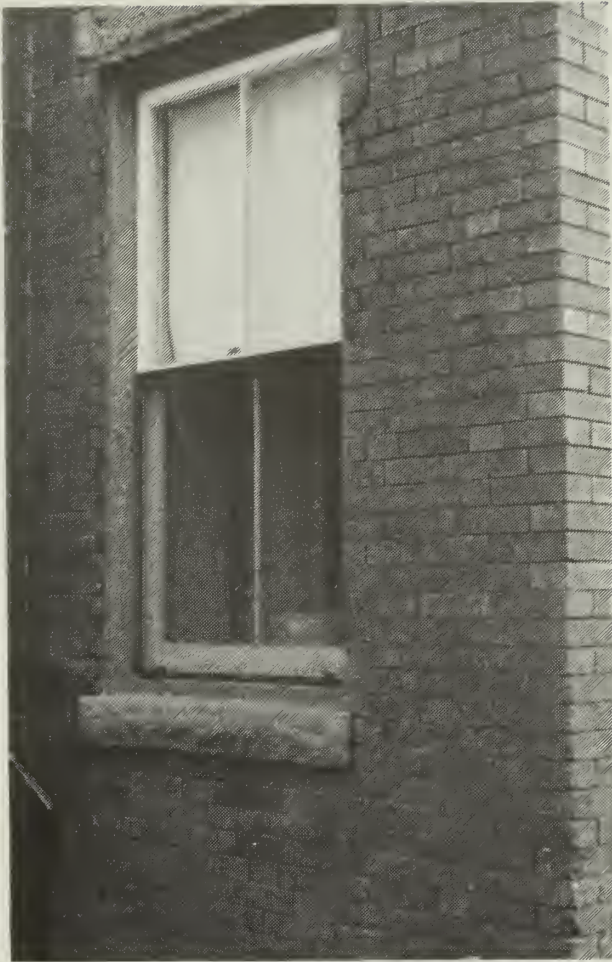

5. New wood replacement window as approved. If possible further refinement (although not required in this case) would have been to install the half screen on the inside rather than on the front of the upper and lower sash.



6. Post-rehabilitation photograph of historic rowhouses with matching wood windows.

Interpreting the Secretary of the Interior's Standards for Rehabilitation

Number: 87-089

- Applicable Standards:
2. Retention of Distinguishing Architectural Character (nonconformance)
 5. Sensitive Treatment of Distinctive Features and Craftsmanship (nonconformance)
 6. Repair/Replacement of Deteriorated or Missing Architectural Features Based on Historical Evidence (nonconformance)

Subject: INCOMPATIBLE REPLACEMENT WINDOWS: CHANGES IN SHAPE AND DIMENSIONS OF WINDOW SASH AND MUNTINS.

Issue: The selection of replacement windows that successfully match the visual qualities of historic windows involves a thorough understanding of the importance of the individual elements of the historic windows themselves. The shape and dimensions of muntins and sash can be particularly important in large, multi-pane sash that are repeated across a simple, architecturally unadorned facade. In many historic industrial, institutional and multi-story commercial buildings, the rhythm created by the rows of windows across the facade becomes a strong design feature and as such, important in defining the historic character of the building. Seemingly small differences between the replacement window and the historic window, such as the muntin shape or size, cumulatively can change the overall appearance of the building, and result in failure of the rehabilitation to meet the Secretary of the Interior's Standards for Rehabilitation.

A late-nineteenth-century mill building located in a registered historic district was distinguished by its strong horizontal form, low gabled roof, and large, multi-pane windows. The historic windows were wood, 16-over-16 double-hung, arch-headed sash, and unfortunately very deteriorated (see illus. 1-2). The repetitive spacing, design and detail of the sash, and planar qualities of the double-hung windows created a strong visual pattern on the otherwise unornamented facade. These windows, therefore, were the dominant architectural feature of the building. As such, preservation of their visual qualities was critical to preserving the historic character of the building.

The replacement windows, however, did not adequately duplicate the visual qualities of the historic windows, specifically in appearance, shadow lines, muntin detail and planar qualities. In addition to the change from an arch-headed to a square-headed sash, a number of other distinct changes have occurred to the historic appearance of these windows. The double-hung, historic wood windows have been replaced by fixed metal units with much narrower sash dimensions, noticeably changing the planar relationship of the upper and lower sash. The resultant effect is that at certain angles the replacement windows have the appearance of the upper and lower sash being in the same plane, rather than duplicating the appearance of the historic, double-hung sash (see illus. 3-5).

The thickness of the meeting rail so evident in the historic sash has been reduced in depth creating a weaker shadow line (see illus. 5). The use of an applied aluminum muntin grid rather than true 16-over-16 wood muntin divisions has caused significant changes to the appearance of the windows (see illus. 6). The muntin grid clearly does not match the original, since the new muntins have a rectangular rather than trapezoidal profile, it has a ribbed surface, and it extends beyond the plane of the rails and stiles. The projecting grid, furthermore, creates additional shadow lines that did not exist on the historic windows. The historic muntins were flush to the surface of the sash, integral to the sash frame construction and trapezoidal in shape after puttying.

These numerous deficiencies give an awkward and incompatible appearance to the windows and the overall building that is especially noticeable given the large size and number of the openings. As a result, the window replacements were determined to be inconsistent with the historic character of the building and therefore do not meet Standards 2 and 6.

Prepared by: Jean E. Travers, TPS

These bulletins are issued to explain preservation project decisions made by the U.S. Department of the Interior. The resulting determinations, based on the Secretary of the Interior's Standards for Rehabilitation, are not necessarily applicable beyond the unique facts and circumstances of each particular case.



1.

1-2. Pre-rehabilitation view of the building showing deteriorated 16-over-16 windows. Note previous owner's effort to duplicate arch-headed sash with sample unit on 2nd floor. In the view below, note how the upper and lower sash are set on different planes, a characteristic feature of double-hung windows.



2.

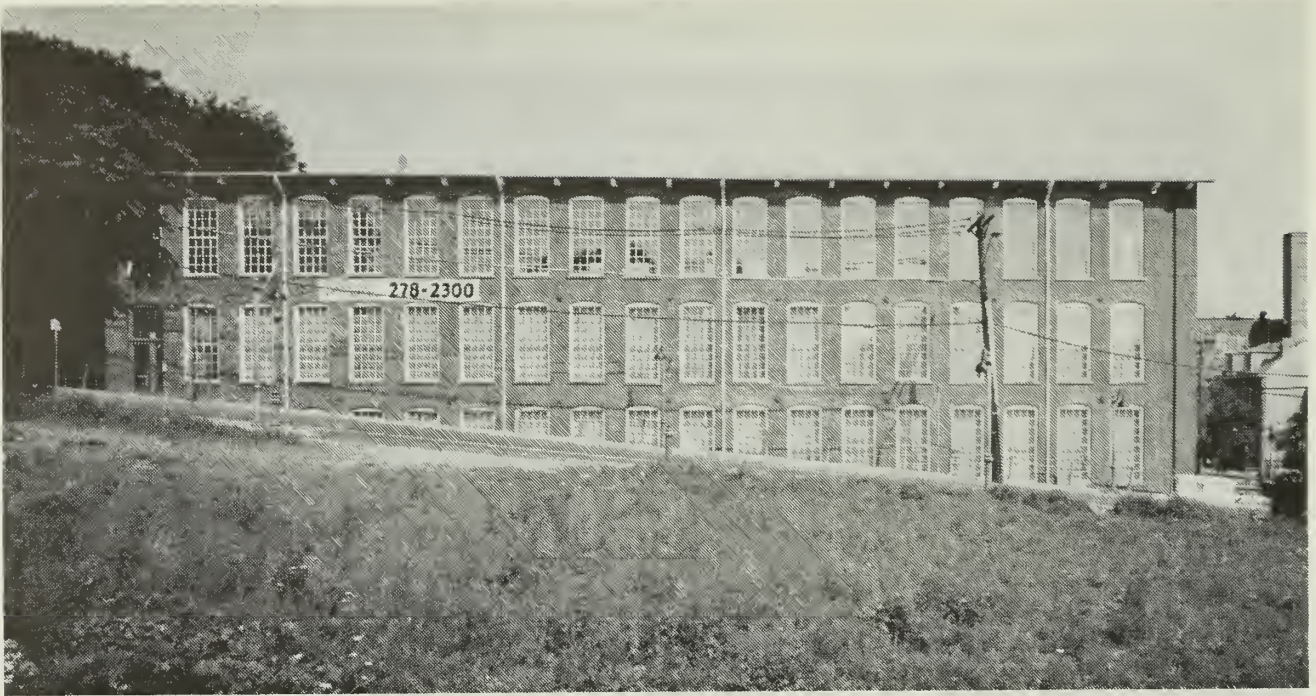

3.

3-5. Post-rehabilitation view of the building showing replacement windows. In 5, note how the reduction in depth of the meeting rail has produced a flat appearance to the window. The appearance of a historic double-hung window with sash on different planes and a heavy shadow line created by the meeting rail has been lost.



4.

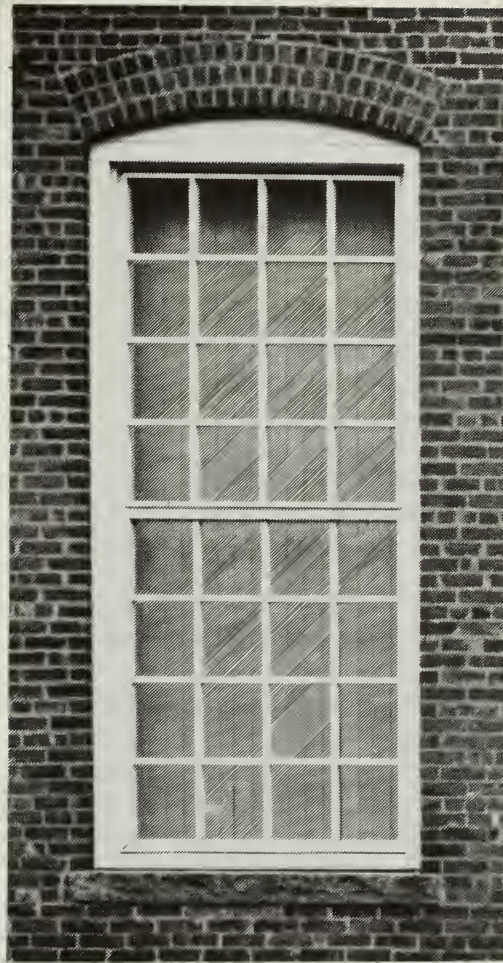

5.

Vertical Section of Replacement Window

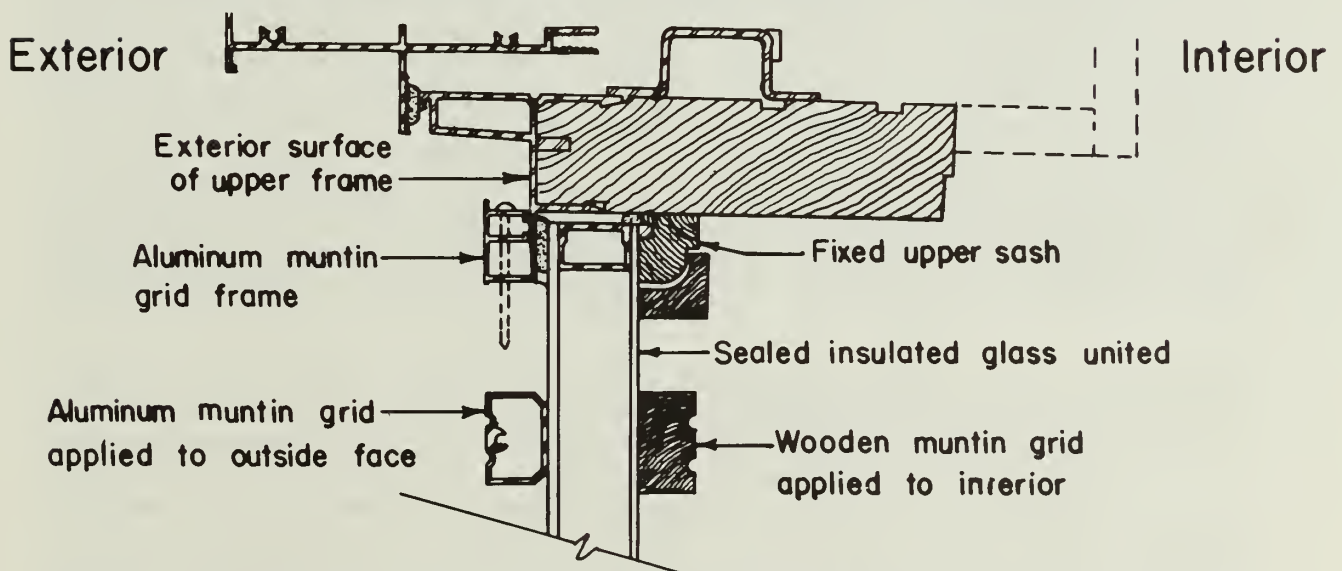

6. Shop drawing showing applied muntin grid projecting beyond the exterior surface of the sash. Also note rectangular shape and the two grooves on the interior and exterior muntin grids which produce the ribbed appearance and additional shadow lines that did not exist on the historic windows.

Interpreting the Secretary of the Interior's Standards for Rehabilitation

Number: 87-090

- Applicable Standards:
2. Retention of Distinguishing Architectural Character (nonconformance)
 5. Sensitive Treatment of Distinctive Features and Craftsmanship (nonconformance)
 6. Repair/Replacement of Deteriorated or Missing Architectural Features Based on Historic Evidence (nonconformance)

Subject: INCOMPATIBLE REPLACEMENT WINDOWS: CHANGES IN COLOR, SIZE, AND CONFIGURATION OF SASH AND FRAMES

Issue: The selection of replacement windows that successfully match the visual qualities of historic windows involves a thorough understanding of the importance of the individual elements of the historic window themselves. Some of the important elements that must be considered are the size and shape of the frames and sash, muntin and mullion profiles and configuration, the configuration of the window itself, the reveal of the window (depth of the window within the opening) and trim detailing around the frames. In some cases, the historic color of the window, if known, can also be important in defining its historic character. Failure to specify and install replacement windows that adequately match the visual qualities of historic windows will result in failure of the overall rehabilitation to meet the Secretary of the Interior's Standards for Rehabilitation.

Application: Window replacements were planned as part of the rehabilitation of three revival-style commercial buildings located in a registered historic district and built between 1920 and 1930 (see illus. 1-3). The historic windows above the storefronts were wood, residential in scale, double-hung, multi-pane sash typical of the early-twentieth-century revival styles (see illus. 4-5). The windows were characterized in part by narrow muntins, meeting rails, and sash. The attenuated proportions of the wood members created a delicate appearance of the historic frames and sash that was a character-defining feature of the historic windows and the building. In addition, groupings of double-hung windows were common; heavy mullions separated the window units and featured a raised vertical edge. The frames and sash were painted dark green. Historical photographs of the buildings also indicated the frames and sash were painted a dark color, a traditional color treatment for red brick, Colonial-revival style and stucco, European-revival style buildings.

Aluminum, double-hung windows with attached metal grids on the exterior and interior to simulate muntins were chosen to replace the originals (see illus. 6-7). Several of these windows were installed to evaluate their effectiveness in matching the adjacent historic windows. These windows were, however, determined not to adequately duplicate the visual qualities of the historic windows in their color, proportion, size, and installation detail of the originals. A light ivory color was chosen, rather than the dark green of the historic sash, causing the windows to stand out against the facade rather than to recede as the dark-colored historic sash had done (see illus. 8). The new

sash and frames were not properly sized to custom-fit the openings in the manner of the originals. As a result, the amount of glass area was reduced and the delicately-designed appearance of the historic frames and sash was replaced by a much heavier appearing unit. The meeting rails of the replacement unit were almost twice the thickness of the historic ones, and the grids, although trapezoidal-shaped, were significantly wider than the historic muntins. The blocking of the opening reduced the sash area while significantly increasing the exposure of the frame with its attached aluminum subframe and metal panning. The flat metal panning bore no relationship in size or profile to the historic wood molding detail found around the frames of many of the historic windows in the buildings. It also was proposed that the mullions in the multiple window bays be covered in metal in a manner that would eliminate the decorative edge detailing. Finally, the appropriateness of the metal grids on residential scale windows of this type on low-rise buildings was a questionable treatment. These numerous deficiencies resulted in denial of certification for tax benefits.

Although this window unit was manufactured by a company that had produced compatible replacement windows for historic buildings, the company typically designs windows for larger openings. This particular window unit was unsuitable as a replacement for the small-scale, residential style windows of these three buildings. On a larger window opening, the dimensions of the meeting rail and grid might have been acceptable. But no reduction in the dimensions of the members was made when the sash size was reduced to fit these small windows, and the sash were not made to custom-fit each opening or the size of the historic sash.

The owner asked if an alternative panning shape more similar to the profile of the historic frame and brick molding would sufficiently replicate the historic appearance of the windows. Close examination of the shop drawings (see illus. 9) identified that the problem could not be rectified by a different panning shape, since the inappropriate color, size and configuration of the members and installation detailing would not be affected. Nothing short of a different window unit, correctly sized and detailed and in an appropriate dark color, would resolve these difficulties and bring the project into conformance with the Secretary's Standards.

Prepared by: Jean E. Travers, TPS

These bulletins are issued to explain preservation project decisions made by the U.S. Department of the Interior. The resulting determinations, based on the Secretary of the Interior's Standards for Rehabilitation, are not necessarily applicable beyond the unique facts and circumstances of each particular case.



Building 1

1-3 Pre-rehabilitation views demonstrate the residential scale of the second and third floor windows. Note how the dark color of the window sash and frames makes the windows less prominent on the upper floors of buildings 2 and 3.



Building 2



Building 3

87-090

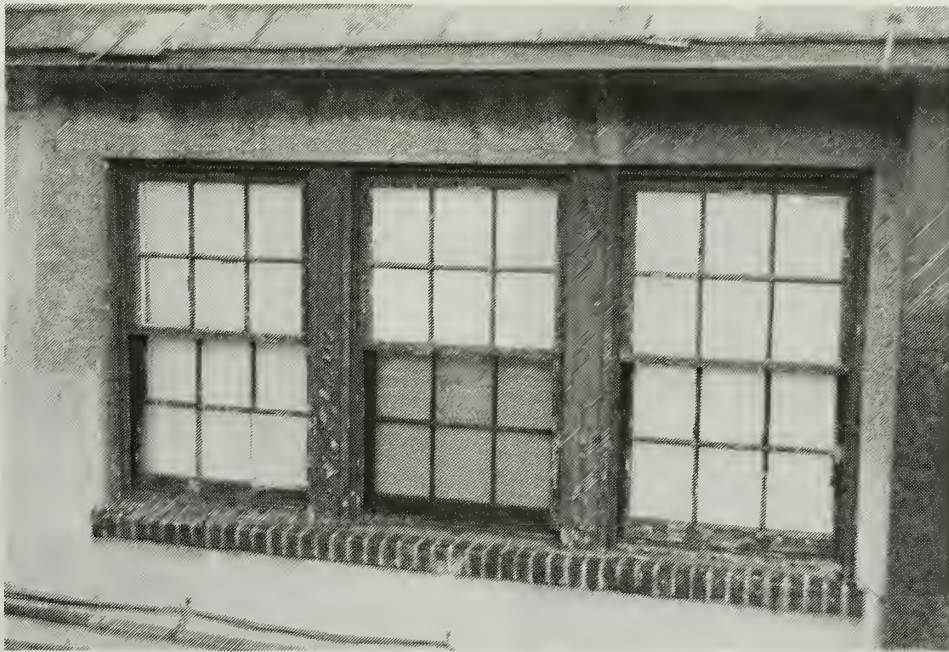

4-5. Pre-rehabilitation views of the deteriorated historic windows. Note beaded mullion above, thin muntins, meeting rails and sash on paired windows and the simple double-hung window below.

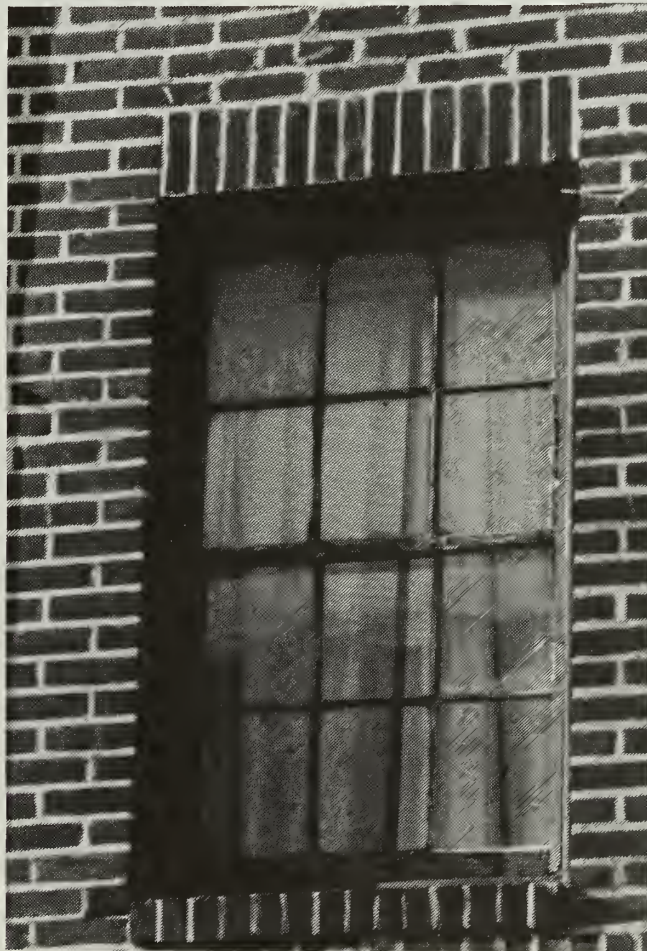

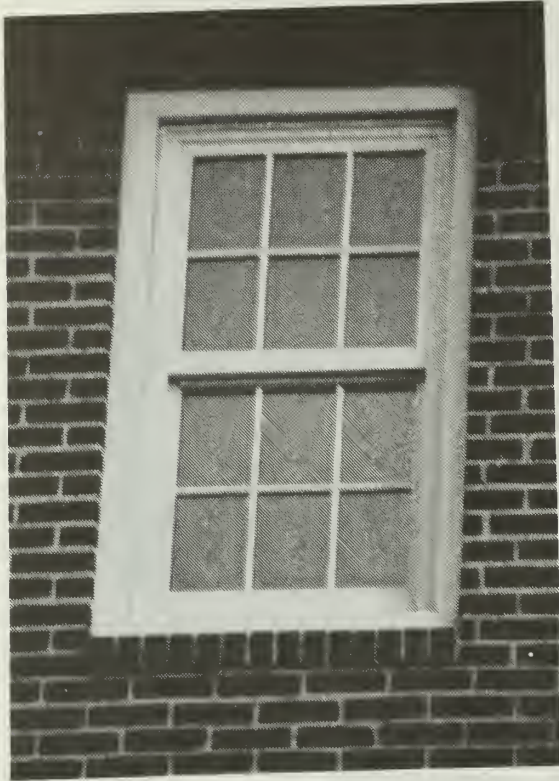

6. Proposed replacement window, exterior. Note rectangular panning, extensive subframe creating additional shadow lines. Compare the meeting rail and muntin dimensions with the historic sash in 4-5.

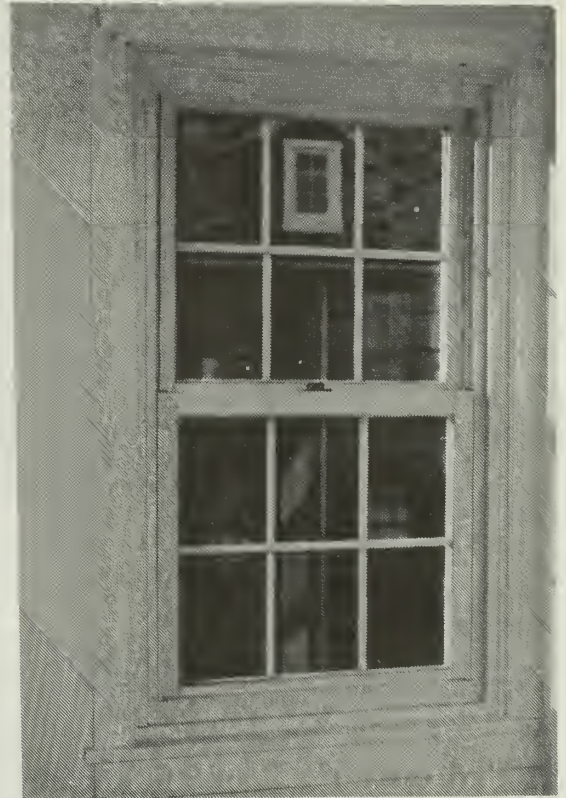

7. Proposed replacement window, interior. Note the three layers of metal comprising the subframe, and the decreased size of the sash and glazed surface within the opening.



8. Proposed replacement windows on third floor and original windows below. Note how dark sash and frames are unobtrusive, light sash and frames create a striking pattern on the red brick facade.

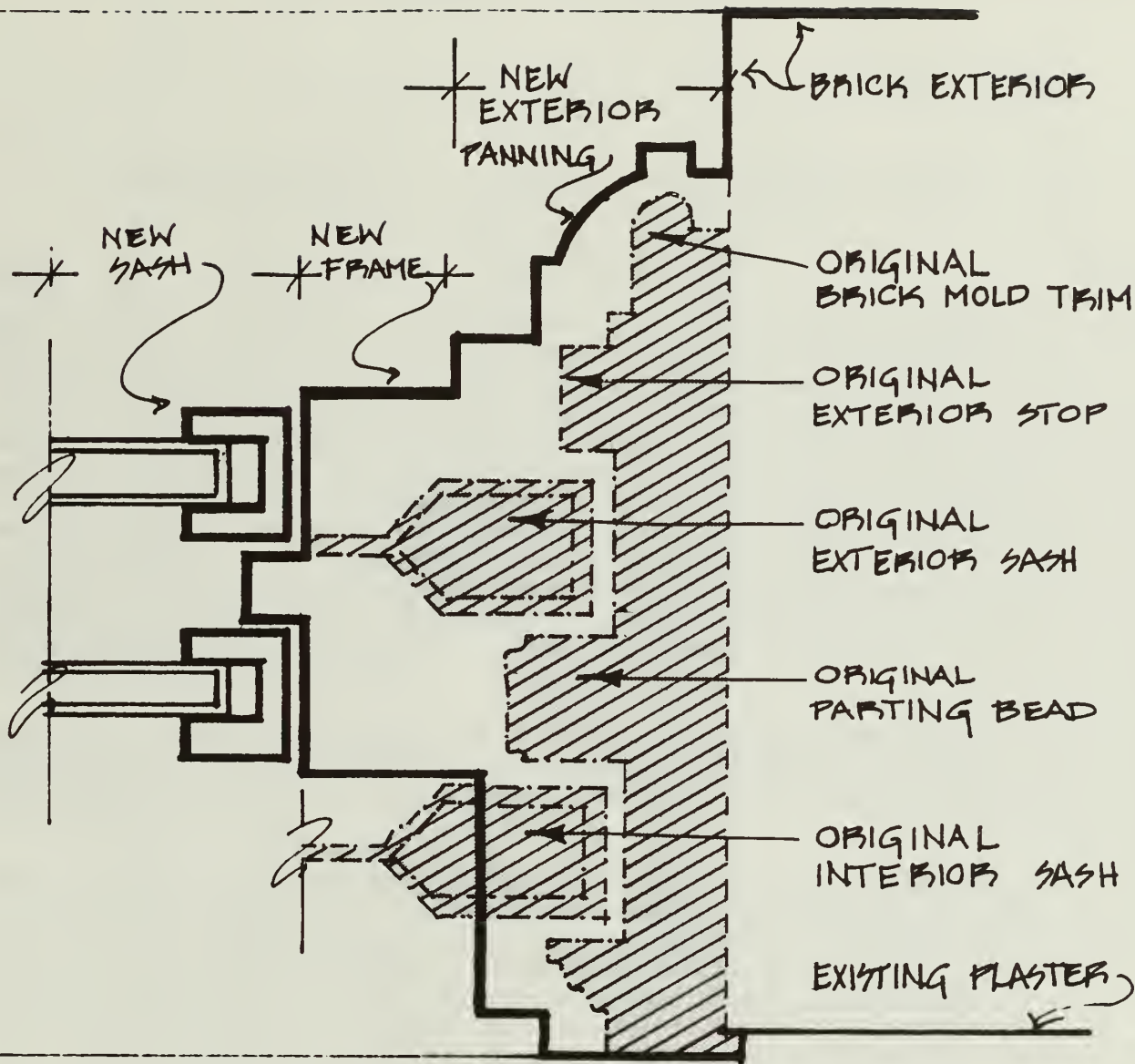

9. Drawing of proposed window and original window and frame location. Note how new sash and frame are set closer to the exterior and within the window opening. The owner's alternative panning identified above will not correct the deficiencies of the sash.

Interpreting the Secretary of the Interior's Standards for Rehabilitation

Number: 87-091

Applicable Standards: 9. Compatible Design for New Alterations/
Additions (nonconformance)

Subject: ADDING TO FREESTANDING HISTORIC BUILDINGS

Issue: The first consideration in planning a new addition is the potential physical impact on significant historic materials and features. Probably of equal importance, however, is the potential visual impact on the building's historic appearance or "character." Because freestanding historic structures are often visible from all four sides, they tend to be particularly vulnerable to exterior change. For this reason, if the factors of size and high visibility are not carefully weighed prior to construction of the new addition, a distinctive historic form and profile can easily be expanded into a building with a completely different character. When a new addition is simply too large in relationship to the freestanding historic building, then placing it on a secondary elevation, using a reveal, using compatible materials, and making a clear differentiation between old and new may still not offset the addition's impact on the historic character. When it is determined that a new addition violates Standard 9, project certification will be denied.

Application: In three rehabilitation projects under review by the National Park Service, the size of the new addition was the major cause for denial. In each case, the historic structure was a freestanding building (a residence, a school, and a bank) with a distinctive form or shape.

First, a two-story vernacular brick residence dating from 1915 recently underwent rehabilitation for use as a dormitory. When a new, large-scale addition was attached on a secondary, but highly visible, elevation as part of the project, NPS denied the project for preservation tax incentives. While recognizing the success of the architect in differentiating the new construction from the historic building (including wall reveals, roofing material, face brick with a soldier course, and windows and cornice details), NPS determined "the addition overwhelmed the historic structure in mass and was too prominently sited." Before rehabilitation, the historic building was asymmetrical in shape, consisting of a main block and several subsidiary--but proportionally similar--components and highlighted by a prominent wraparound wooden porch. After rehabilitation, the form was still asymmetrical, but the new brick addition became the most prominent architectural feature of the building from several elevations, its distinctive angular form dwarfing the historic porch in size and scale. In summary, the addition drastically changed the form of a residence that was typical of its time, and, in changing the form, compromised the historic character (see illus. 1 and 2).

In the second case, a 1926 classically-styled freestanding bank building with large round-arched window openings was rehabilitated to extend its historic commercial function. When new bank offices were added along one side of the historic building, essentially doubling the size of the historic structure, the project was denied for tax benefits: NPS explained, "The new addition gives the building a radically different

size, shape, and appearance from what it had been for sixty years since its construction... In effect, it obliterates the character of the structure as a freestanding building, nearly obscuring an entire flank." Before rehabilitation, the building was easily identifiable in the district by its symmetrically rectangular mass and balanced formal windows; after rehabilitation, the form of the building became a decisively asymmetrical wedge shape with a prominent new entrance replacing the historic tripartite windows (see illus. 3, 4, 5). The materials and architectural detailing of the new addition were not issues. Finally, NPS stated in the denial letter that a smaller addition could have been certified.

In a third case, a ca. 1839 two story brick structure, three bays wide, with distinctive stepped gables had been expanded in 1912 by a two-story ell when its use as a school for women was changed to use as a private residence. In 1985, the structure was added to again for use as a restaurant, then submitted to NPS for the investment tax credit. Project work included construction of a kitchen and greenhouse addition and construction of a storage building on the site. After review, NPS denied the rehabilitation, primarily citing the impact of the new addition both on the building and the district. In NPS' denial letter, it was stated that "prior to rehabilitation, the structure was a simple, freestanding, L-shaped structure readily identifiable in character." The NPS letter further explained to the owner that after rehabilitation "the historic form of the structure is no longer clearly distinguishable; the kitchen-bakery addition of approximately 2,000 square feet has vastly increased the size of the building, turning the former L-shaped plan into a U-shaped plan and thus obscuring the essential form of the historic structure...the addition overwhelms and competes with the historic structure rather than being subordinate to it." It was noted in the NPS denial letter that making the school into a restaurant would have been a compatible use if the addition had been smaller in relationship to the historic structure; also, the greenhouse addition in itself would not have precluded certification (see illus. 6).

Prepared by: Kay D. Weeks

These bulletins are issued to explain preservation project decisions made by the U.S. Department of the Interior. The resulting determinations, based on the Secretary of the Interior's Standards for Rehabilitation, are not necessarily applicable beyond the unique facts and circumstances of each particular case.



1. The c. 1915 freestanding residential structure is visible from all four sides; an unadorned brick side wall is a foil for the most distinguishing feature of the house--the wood wraparound porch.



2. A new dormitory wing has been constructed on the side elevation shown in illustration 1. Because of its height, degree of projection, distinctive shape, and high visibility, the new addition has become the dominant feature of the house and has changed the historic character.



3. This freestanding bank structure, located at a major intersection in the district, was readily identifiable before rehabilitation by its simple rectangular form and its large, arched openings.



4. The historic bank and new bank addition are shown in relationship to the surrounding streets in the district. The previously rectangular form of the freestanding bank has been dramatically altered by both the size and shape of the addition.



5. Even with a setback, appropriate height, compatible materials, and clear differentiation between new and old, the new work now dominates the resource and the setting. The historic bank can no longer be seen from a major side street.



6. The side and rear elevation of the 1839 brick school building are shown here on the far right (the later ell is not visible) together with three new components added as part of the rehabilitation project--a greenhouse, a kitchen building with stepped gables matching the historic building, and a storage building. Because the new addition has changed the historic character to a dramatic degree, the project was denied tax incentives. A smaller kitchen wing--planned and sited differently--could have been in conformance with the Standards. The greenhouse itself was not an issue.

Interpreting the Secretary of the Interior's Standards for Rehabilitation

Number: 87-092

- Applicable Standards:
2. Retention of Distinguishing Architectural Character (nonconformance)
 9. Compatible Design for New Alterations/ Additions (nonconformance)

Subject: REHABILITATING HISTORIC VERNACULAR STRUCTURES FOR CONTINUED RESIDENTIAL USE

Issue: The most important part of planning an interior rehabilitation is correctly identifying the structure's distinctive materials and its historic spatial character so that they may be satisfactorily preserved within the framework of making changes necessary for either a continued or new use. Vernacular buildings which are characterized by simple rectangular spaces and plain detailing should have their spaces and detailing respected when the overall rehabilitation is being conceived. Some enlargement of rooms laterally by removing partitions could be an acceptable approach if a sense of the historic space, plan, and simplicity of detailing were retained in the process. On the other hand, cutting through floors or ceilings to create dramatic new spaces (and plans) can drastically alter the character of these unadorned vernacular structures. While some loss and change are anticipated in the process of rehabilitation, major modification of character-defining spaces will violate Standards 2 and 9.

Application: A row of 19th century industrial housing--considered the most extensive intact examples of this type of housing in the country--was being rehabilitated for continued residential use. Originally, the 3 1/2 story brick units had served as boarding houses for unmarried textile workers; later in the 19th century, the houses were converted for tenement use. During the 130-year history of the structures, their historic character as mill workers' housing remained. Although some interior modification had taken place with attendant destruction of historic fabric and features, the floor plans and historic interior room arrangements had generally survived. The modest rooms, characteristic of the period of their construction and reflecting the functional simplicity of their historic use, were detailed in a uniform manner throughout the buildings. The floor to ceiling height had been similarly uniform.

The rehabilitation was determined not to meet the Standards owing to the removal of large portions of the first floor in order to create two-story spaces that would permit additional light to rooms newly inserted in the basement. The change radically altered the historic spatial definition of these rooms as well altering the historic relationship of the first and primary floors to other floors in the buildings. This work was totally incongruous with the simple, but distinct historic character of the 19th century residential structures. In a denial letter to the owner, NPS explained further that the continued residential use of these buildings should not have posed any major problem or need for extensive changes to the building's overall historic design:

The character of the historic interior spaces appears to have been easily adaptable for modern residential use. Unfortunately, during the course of your rehabilitation work on these units, large portions of the first floors were removed in order to create two-story spaces. The creation of those two-story spaces required the destruction of both historic material and the distinguishing spatial concept of the most significant areas of each house, in violation of Standard 2.

Furthermore, the design character of the new space is incompatible with the vernacular character of the building, thus violating Standard 9.

An alternative to removing portions of the floor would have been to regrade at the rear to permit more light to enter the basement through enlarged windows. It was further noted by NPS that the incompatible spatial changes were all the more regrettable because they were not essential to a viable reuse scheme for the buildings or to extending their useful life.

Prepared by: Kay D. Weeks

These bulletins are issued to explain preservation project decisions made by the U.S. Department of the Interior. The resulting determinations, based on the Secretary of the Interior's Standards for Rehabilitation, are not necessarily applicable beyond the unique facts and circumstances of each particular case.



1. The historic character of the structures as mill workers' housing remained; that character, as NPS noted, was still forcefully conveyed by both the exterior and the interior.

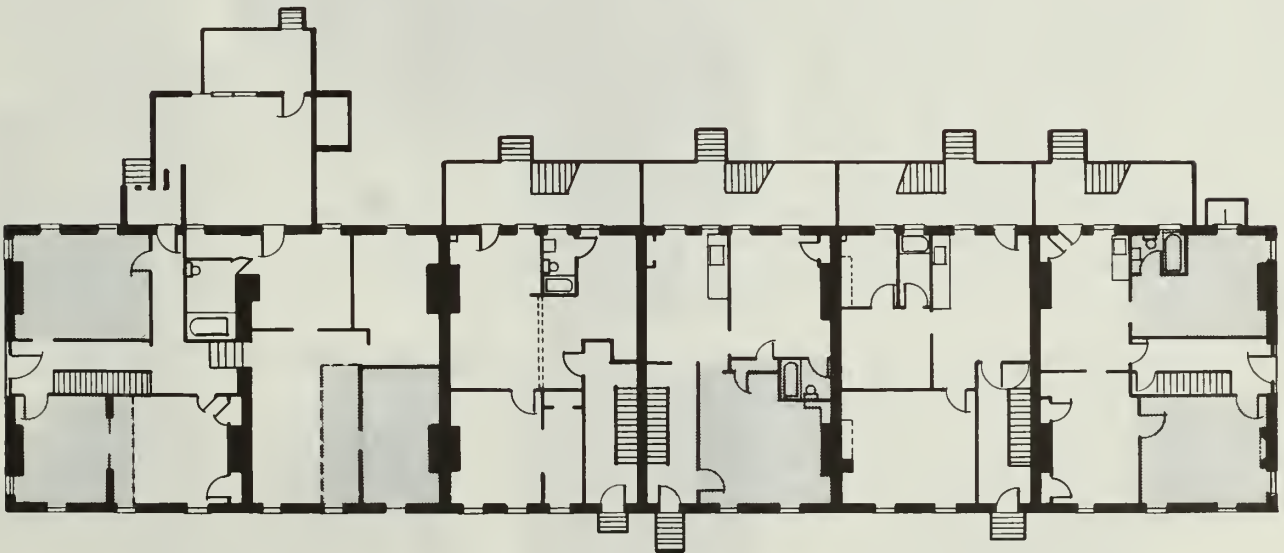

2. The plan shows room size and arrangement; units converted to two-story spaces by cutting through the first floor are denoted by shadowing.



3. A typical room prior to rehabilitation. The room is defined by its flat ceiling, rectangular space, and simplicity of detailing.



4. As part of the rehabilitation, the historic space was dramatically redefined by removing the first story floor, revealing the basement level. Two separate rectangular spaces were then made into one rehabilitated living unit. This inappropriate treatment violated both Standards 2 and 9.

Interpreting the Secretary of the Interior's Standards for Rehabilitation

Number: 87-093

Applicable Standard: 5. Sensitive Treatment of Distinctive Features and Craftsmanship (nonconformance)

Subject: ALTERATION OF INTERIOR LAYOUTS

Issue: Standard 5 of the Secretary of the Interior's "Standards for Rehabilitation" requires that "distinctive stylistic features" characterizing a building be treated with sensitivity. Such features may include the interior floor plan or arrangement of spaces important in defining the historic character of the building. Radically changing a floor plan may result in a loss of historic character.

Application: A three-story, commercial structure built in 1890 was marked by commercial space on the ground floor and office or residential space above (see illus. 1). As a result of many changes over the years, the commercial portion of the building retained little historic fabric; the space behind the storefronts was otherwise undistinguished (see illus. 2). Consequently, the ground floor offered the owner considerable latitude in making changes during the course of the rehabilitation.

The upper floors were distinguished by an oversized atrium extending through the second and third stories. Arranged around this atrium were two distinct rings of rooms, the inner ring fitted with windows intended to borrow light from the atrium, and the outside ring lit by exterior windows (see illus. 3, and 4). Over the years many of the window sash facing the atrium had been filled in, although their location was clearly evident from the surrounding trim. The open third floor hallway overlooking the atrium had been enclosed (see illus. 5). Nevertheless, despite these changes and some deterioration of fabric and finishes, the distinctive historic floor plan and the unusual sequence of spaces made up by the atrium and double ring of rooms had largely survived (see illus. 6 and 7). The rehabilitation plans for the upper stories called for retention of the atrium but the removal of all historic fabric behind the perimeter walls of the atrium in order to create open plan offices. In addition the perimeter walls of the atrium would be rebuilt in a different configuration, with doors and windows suggestive of the historic ones, but narrower and arranged in different locations.

Despite later alterations, the historic plan and the interior spaces of the building on the upper floors are quite distinctive, even though carried out in relatively simple materials. The arrangement of two rings of rooms around the atrium is unusual for a building of this period and construction and needed to be retained in any project. The proposed rehabilitation would all but obliterate this distinctive configuration, thereby greatly impairing the historic character of the structure, and violating the "Standards for Rehabilitation."

Prepared by: Michael Auer, TPS

These bulletins are issued to explain preservation project decisions made by the U.S. Department of the Interior. The resulting determinations, based on the Secretary of the Interior's Standards for Rehabilitations, are not necessarily applicable beyond the unique facts and circumstances of each particular case.



1. 1890 commercial building prior to rehabilitation.



2. Typical ground floor space before rehabilitation.



3. View of central space showing atrium extending through the second and third floors, with skylight above. The second floor doors shown lead to rooms beyond. Windows have been blocked in, but their configuration is still apparent from the surrounding trim. On the third floor the open hallway had been partitioned.



4. Interior rooms were fitted with windows and doors with transoms to borrow light from both the exterior window walls and the rooms facing the lighted atrium.



5. On the third floor, the historic hallway, originally open, had been fitted with a solid partition; the offices behind it, however, were relatively unaltered.

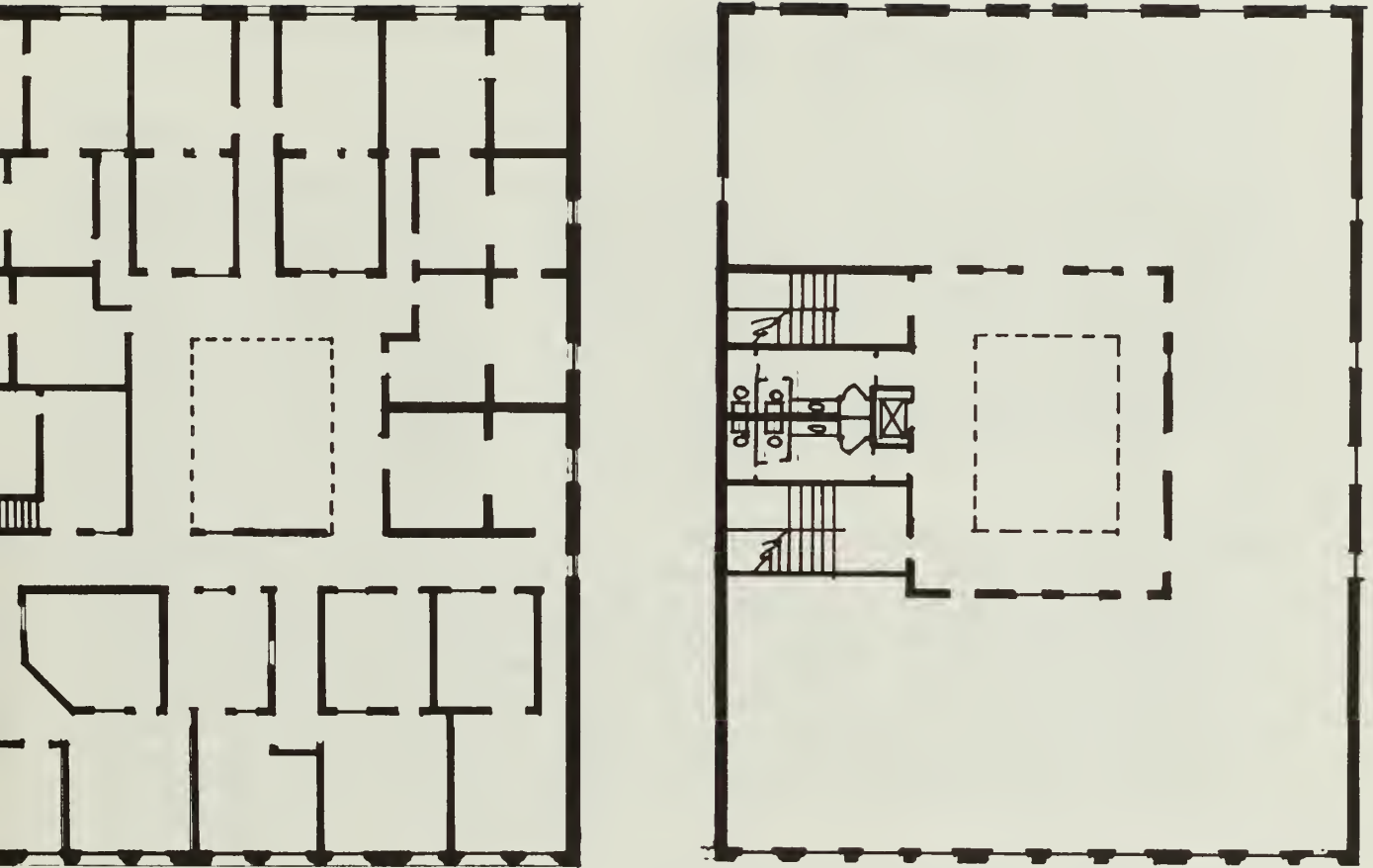

6 and 7. Historic second floor plan of atrium, hallway and inner and outer rings of rooms (left). In the proposed rehabilitation (right), this distinctive arrangement would be destroyed.

Interpreting

the Secretary of the Interior's

Standards for Rehabilitation

Number: 87-094

Applicable Standard: 2. Retention of Distinguishing Architectural Character (nonconformance)

Subject: INCOMPATIBLE ALTERATIONS TO SIGNIFICANT REAR ELEVATIONS

Issue: Before initiating a rehabilitation project it is important to first identify those features which are character-defining and which must be preserved. While there may not be much doubt whether the primary or front elevation is significant, it is not always as easy to determine when the sides and rear, or secondary, elevations are also character-defining. However, when a secondary elevation exhibits fine stylistic detailing, shape or form unique to the building type or use, when it is highly visible or of special historical or social significance to the historic district or neighborhood, it is likely to be worthy of preservation. If such a character-defining elevation is not preserved in the rehabilitation, the project will not be in conformance with the Standards and will be denied certification.

Application: A vacant and derelict armory building individually listed on the National Register was rehabilitated for use as residential apartments. Built in 1912 of red brick, the armory was designed in an appropriately militaristic style featuring an arched entranceway flanked on either side by a projecting three-sided corbelled bay, and a three-story tower. The armory is comprised of two sections: a two-story, L-shaped, flat-roofed head house provides the primary elevation facing the street, and adjoins a one-and-one-half story, gabled-roof drill shed which spans across the rear of the head house, and extends four bays past the edge of the head house (see illus. 1). The drill shed parallels the river (which the rear of the shed faces) and is visible from the town across the river (see illus. 2-3).

Despite several alterations made in the 1950s and some deterioration and vandalism which occurred during the nearly 15 years the buildings had been vacant, the armory had survived in a remarkably intact state prior to rehabilitation. The interior of the head house, including a large entrance hall, company parlor, and numerous small rooms on both floors, easily accommodated the apartment conversion which was accomplished with a minimal loss of historic fabric and character. The interior of the 75 x 300 feet drill shed was a completely open space with exposed steel trusses and a suspended gallery at one end (see illus. 4). During the rehabilitation this large open space was converted into twenty apartments by creating two floor levels. To provide light into these apartments, skylights were added to the rear of the roof of the drill shed, and the rear wall was reconfigured by removing the original paired nine-over-nine wood sash windows along with a substantial amount of brick between the piers (see illus. 5-6). Nine prefabricated, panelled units which incorporated walls, windows and doors were inserted in these newly made openings along the entire length of the rear elevation. Wooden decks with privacy screens and steps to the parking lot were added for the first floor apartments (see illus. 7).

If the open space within the drill shed had been a significant, highly detailed space, the insertion of twenty apartments on two levels would very likely have been in

87-094

violation of the Standards. In this particular case, however, while the concept of introducing multiple units into the very plain, open space of the drill shed was in conformance with the Standards, the specific treatment of the rear elevation was not, and the project was denied certification.

The drastic changes to the fenestration of the rear elevation were cited as cause for denial. The existing historic window openings could have been altered in a manner that would have provided light and access to the rear apartments while still leaving enough brick to maintain the character of the rear wall. Instead, as the project was carried out, the wholesale removal of the sash and most of the brick between the piers added up to a significant loss of historic fabric. However, it is the change in character of the rear elevation that is most damaging. Installation of the prefabricated panels resulted in unacceptable changes in: color and texture (brick red to stark white, smooth panels); materials (brick and wooden window sash to prefabricated panels and aluminum windows); composition (distinctly vertical to distinctly horizontal); and design (industrial to residential). Addition of the wooden decks further obscured what remained of the brick, and emphasized the incongruous domestic appearance of the rear elevation. Furthermore, the elevation now is highly visible to those entering the apartments from the parking lot, and to neighboring houses.

Prepared by: Anne Grimmer, TPS

These bulletins are issued to explain preservation project decisions made by the U.S. Department of the Interior. The resulting determinations, based on the Secretary of the Interior's Standards for Rehabilitation, are not necessarily applicable beyond the unique facts and circumstances of each particular case.



1. The facade of the armory before rehabilitation. The gable-roofed drill shed extends four bays beyond the head house with its three-story tower and three-sided corbelled bay.

2. The rear elevation of the drill shed. Note the paired, nine-over-nine wood sash windows and the high sills which provide much of the character.





3. View from the rear of the property behind the drill shed looking through the trees to the town across the river.

4. The interior of the drill shed before rehabilitation, showing the exposed steel trusses and the suspended gallery at one end.





5-6. The rear elevation of the drill shed during rehabilitation. Note the extensive loss of brick, and how the character has changed with the removal of the multi-paned wood sash and the creation of large openings.

87-094



7. The rear of the drill shed showing the completed rehabilitation with the new skylights in the roof, the prefabricated panels filling the former bricked areas, and the new wood decks and privacy fences facing onto a parking lot at the rear of the property.

Interpreting the Secretary of the Interior's Standards for Rehabilitation

Number: 87-095

- Applicable Standards:
2. Retention of Distinguishing Architectural Character (nonconformance).
 9. Compatible Design for New Alterations/Additions (nonconformance).

Subject: NEW CONSTRUCTION IN HISTORIC DISTRICTS: INCOMPATIBLE ALTERATIONS TO HISTORIC SETTING

Issue: The setting of a historic building can be an important element in defining its character. Setting is defined as the relationship of the historic building to adjacent buildings and the surrounding site or environment: it is the arrangement of man-made features, such as buildings and structures and their relationship to each other and to their natural environment, such as open spaces, topographic features, and vegetation.

The Secretary's Standards address the importance of preserving the historic setting of a building or district in Standards 2 and 9. Standard 2 emphasizes the need to protect distinguishing original qualities or character of a building or site and its environment. Standard 9 addresses the necessity of designing alterations and additions that are compatible with the character of the property and its environment. The setting of a historic resource is often quite fragile, particularly in rural areas where buildings and structures are surrounded by large expanses of open space, and in industrial complexes where buildings were constructed in specific locations for functional reasons. New construction on, or adjacent to, historic buildings, if not carefully planned and executed, can dramatically alter the historic setting of adjacent buildings or the district. Such work may not meet the Secretary of the Interior's Standards.

Application: A historic district significant as an early-nineteenth century textile manufacturing center was rehabilitated as a rental housing community. The district was significant in part for its founder's early attempt to group buildings by their functions (such as housing and milling) to take advantage of the natural terrain. Historically, milling functions were placed adjacent to the river where a waterway system was constructed. Buildings for housing and community activities were grouped separately across fields (see illus. 1). Although industrial functions had ceased years before, and the buildings were deteriorated at the time rehabilitation began, the historic setting of the district, in particular the portion of the district where milling functions occurred, remained intact. The industrial portion of the district included a large mill spanning the river, a machine shop, ruins of another associated mill building, an early twentieth century frame structure used as an office, and waterway system linking the buildings to the pond and river. These buildings and structures were situated across a field and visible from the main street running through the district (see illus. 2-3).

The rehabilitation included the conversion of several of the historic buildings in the district into apartments. In the area where milling functions occurred, the machine shop and an adjacent frame building were rehabilitated for housing, and a free-

standing, two-story apartment block was constructed (see illus. 4). (Two additional apartment blocks were constructed outside the district boundaries.) The frame building was substantially altered during rehabilitation and is now linked by a new addition to the machine shop (see illus. 5). Illus. 6 and 7 also show the new apartment building constructed in the field directly in front of the machine shop and frame building.

The large addition to the frame building and new construction has produced a more densely developed environment in the area in front of the machine shop than that which existed prior to rehabilitation or historically. It has eliminated the visual separateness of the mill buildings from the historic residential buildings in the district, and obstructs the visibility of the machine shop from the street which is a main vantage point in the district. In addition, the new construction is incompatible in design with the historic buildings. The historic mill buildings, in particular the machine shop, were simple, unadorned elevations with ordered rows of windows on each floor. The new construction, including the alterations and addition to the frame building, are characterized by their asymmetrically massed roof forms, porches, projecting bays, and have prominent features such as window shutters and palladian windows. This new construction is not compatible with the historic setting and design of the mill buildings and is inconsistent with the historic character of the district. The project work, therefore, does not meet Standards 2 and 9.

Prepared by: Jean E. Travers, TPS

These bulletins are issued to explain preservation project decisions made by the U.S. Department of the Interior. The resulting determinations, based on the Secretary of the Interior's Standards for Rehabilitation, are not necessarily applicable beyond the unique facts and circumstances of each particular case.

PRE-REHAB SITE PLAN

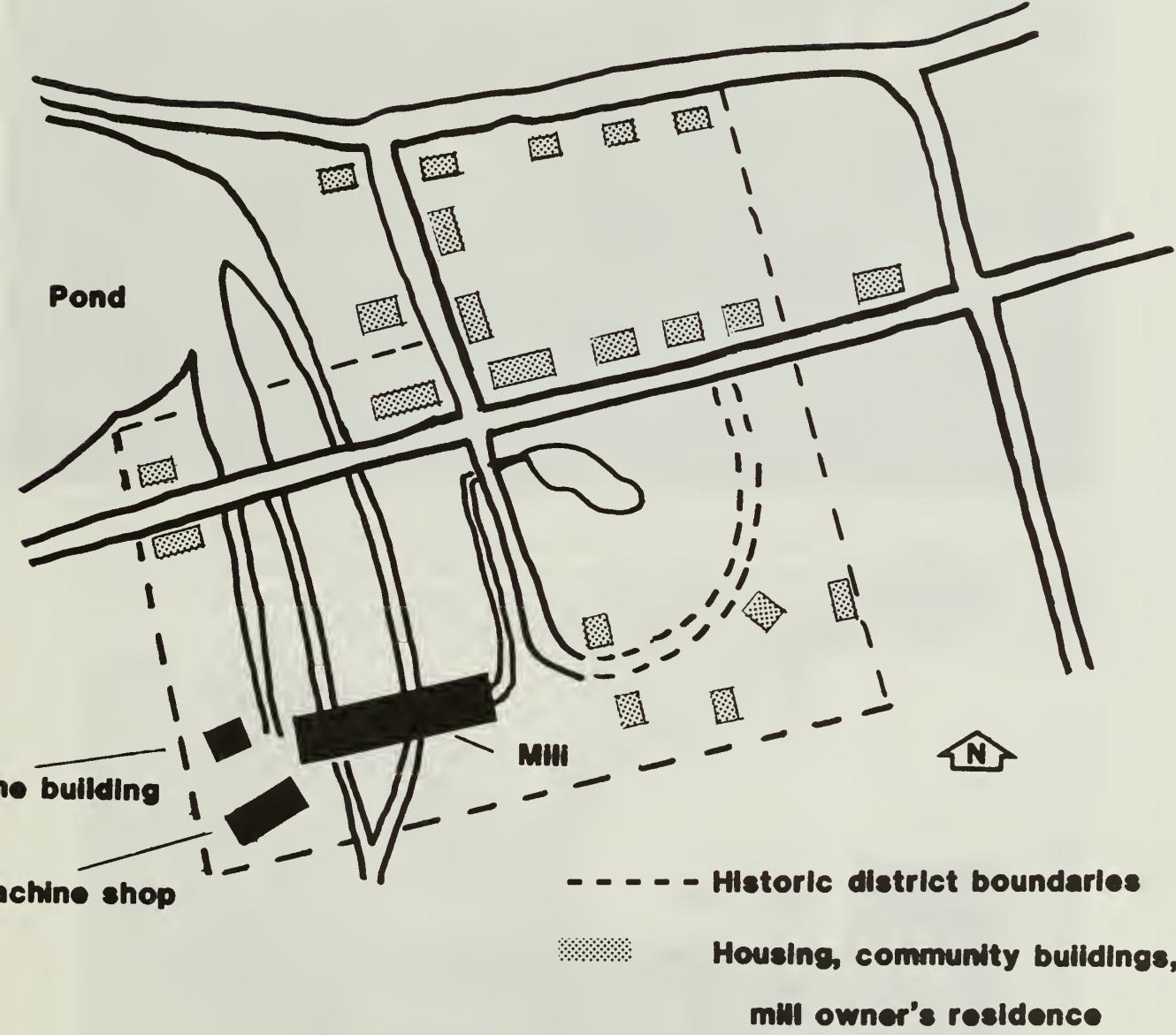

1. Site plan of the district prior to rehabilitation. Note location of the mill and mill-related buildings in the SW corner of the district.



2-3. Pre-rehabilitation views of the machine shop, frame building, and the mill. The National Register record states "the mills are set across a wide meadow at the end of a formal system of waterways; their isolation points to the mills as a distinct unit." Note the unadorned, simple quality of these industrial buildings.





4. Post-rehabilitation view of machine shop and frame building. Note alterations to the frame building and new construction in the previous open space. The new construction introduces a variety of architectural forms and features not found on the historic buildings in the district.



5. Note how close the frame building's new addition is located to the machine shop. A wood deck links the two structures. The new addition has created a more densely developed environment than existed prior to rehabilitation, obstructs the visibility of the machine shop, and has introduced architectural forms and features not found on historic buildings in the district. The new construction, therefore, has changed the visual qualities characteristic of the setting of this district.

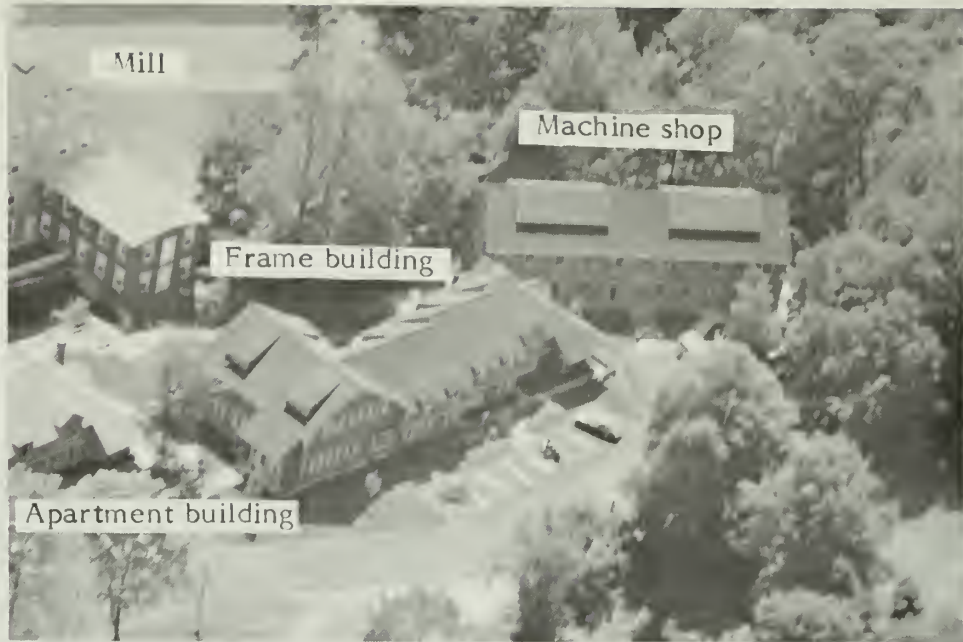

6. Aerial view of this portion of the district showing the alterations to the frame building, and a portion of the free-standing new construction on the left. The machine shop is in the center right of the picture, and the mill is located in the upper left corner. Note the more densely developed environment immediately in front of the machine shop.



7. Aerial view showing blocks of new construction identified as 1, 2, and 3. White line is the approximate boundary of this part of the district.

Interpreting the Secretary of the Interior's Standards for Rehabilitation

Number: 88-096

Applicable Standards:

3. Recognition of Historic Period
(nonconformance)
4. Retention of Significant Later
Alterations/Additions (nonconformance)
6. Repair/Replacement of Deteriorated or
Missing Features Based on Historical Evidence
(nonconformance)

Subject: UNDOCUMENTED "RESTORATION" OF MISSING ARCHITECTURAL
ELEMENTS

Issue: When rehabilitating historic buildings, the repair or replacement of missing architectural elements must be based on solid physical or documentary evidence. For example, old photographs of the building may show a missing element clearly enough to replicate it. Original architectural drawings may also provide this information. Sometimes the outline of the missing feature may be clearly discernible on the facade or elevation of the building, or may be revealed after removal of a later covering such as asbestos or aluminum siding. An accurate reconstruction of the feature such as a porch or a rear ell may be based, in part, on excavations made to determine its size and depth by the location of buried footings. Finally, key elements may be found such as balusters or porch railings that were stored in attics or basements when they were removed in an earlier remodeling.

Any of these situations can provide useful clues necessary to carry out an accurate reconstruction of the lost element. However, reconstructions that are not based on such physical or documentary evidence, but merely on hearsay or a theoretical design, cannot be verified historically, and generally are not in accordance with the Secretary's Standards. If, during rehabilitation, some indication of a missing feature is encountered, unless adequate documentary evidence exists to guide an accurate reconstruction, it is better not to attempt such a treatment, but instead to design a replacement that is new but also compatible with the historic building. It is also important to remember that later additions or replacements for the earlier feature may have acquired significance over time; if so, they should be retained. Furthermore, if missing architectural elements are restored on a selective basis, the completed building may take on an appearance it never had historically.

Application: A circa 1872 Italianate brick house, part of a farm complex individually listed on the National Register, was rehabilitated for use as a bed and breakfast establishment. The impressive, two-story house (see illus. 1), features segmental arched door and window openings, a bracketed wood cornice, a lozenge-patterned colored slate hipped roof and cast iron roof cresting. When first constructed, the house had four porches--on the front, both sides and the rear. Over time, these porches had been removed, and only their "ghost" outlines on the brick walls (and the

fact that exterior doors remained on the second story that had apparently opened out onto porch roofs) provided clues to the fact that porches had ever existed. Although the original porches were gone, a later, elliptical terrace surrounded by a low, rusticated cast-stone wall, probably constructed around the turn of the century, existed on the primary facade of the house at the start of the rehabilitation.

As part of the rehabilitation, the owner removed this elliptical terrace and wall from the front of the house and decided to "reconstruct" the original porches. Instead of using the very distinct "ghost" outlines (which had been removed by the owner during cleaning of the exterior brick), the owner used pieces of wood brackets found on the property as models to construct new porches. These bracket fragments, the owner speculated, came from the "original" porches that had been described by area residents as preceding those porches which had left their physical profile on the brick (see illus. 2-3).

The rehabilitation project was determined not to meet the Standards because the design of the new porches was not based on conclusive pictorial or physical evidence. The new designs did not match the outlines on the masonry, nor were they based on historic photographs or architectural drawings of the house. The porches give the house an appearance that is not verifiable, yet appears to be historic. This violates Standard 3. Although the intention of the owner was to restore the house to what he believed to be its original 1872 appearance, in the absence of clear and indisputable documentation as to what this was, two appropriate approaches would have been to have left the porches off the house or to have based the porch reconstruction on the physical evidence (outlines) of the former porches that still remained on the brick when the property was first acquired.

The surviving bracket outlines could have provided ample guidance for quite closely replicating these porches. Excavation in front of the doorways might have revealed evidence of the location of footings that supported the porches, to document the depth of the porches.

The owner, of course, had the option to retain the elliptical cast-stone wall. Although clearly of a later period, this wall did not detract from the Italianate character of the house. Its retention would have been in accordance with Standard 4, and reconstructed porches based on the "ghost" outline would also have been compatible with the wall.

Prepared by: Anne Grimmer, TPS

These bulletins are issued to explain preservation project decisions made by the U.S. Department of the Interior. The resulting determinations, based on the Secretary of the Interior's Standards for Rehabilitation, are not necessarily applicable beyond the facts and circumstances of each case.



1. The house as it appeared when acquired by the current owner. Note the "ghost" outline of a porch on the front, the second floor exterior doors, and the elliptical cast stone terrace.



2-3. The reconstructed front porch (left) and the side porch (right). Their designs were based on bracket fragments found on the property combined with area residents' descriptions of the porches as they remembered them, but did not match the "ghost" outlines that had existed on the brick prior to cleaning.

Interpreting the Secretary of the Interior's Standards for Rehabilitation

Number: 88-097

- Applicable Standards:
2. Retention of Distinguishing Architectural Character (nonconformance)
 9. Compatible Design for New Alterations/Additions (nonconformance)

Subject: INCOMPATIBLE SITE WORK

Issue: Vacant lots adjacent to historic buildings often provide convenient locations for stairtowers, parking lots and other work undertaken as part of an overall rehabilitation project. Department of the Interior regulations state that a rehabilitation undertaken for purposes of the investment tax incentives "encompasses all work on the significant interior and exterior features of the certified historic structure and its setting and environment." Development on adjacent lots may result in denial of certification if the site work radically affects the "historic qualities, integrity or setting of the certified historic structure." (36 CFR 67.6(b)).

Application: A four-story, three-bay brick structure built about 1869 and located in a historic district noted for its brick warehouse and commercial structures was rehabilitated for use as residential apartments. The rehabilitation of this structure was undertaken as part of a larger project involving three other buildings (see illus. 1 and 2).

In order to provide access to this structure and to the neighboring buildings, an entrance courtyard was created on the vacant lot bordering all four structures (see illus. 3). Principal elements of the new construction included a wall at the property line, an entrance pavilion, a three-story steel exterior stairtower, a wall at the mid-point of the lot and a covered walkway highlighting the entrance to the building at the rear (see illus. 4 and 5). Additionally, the lot was excavated to provide light and access to new below-grade apartments (see illus. 6).

The new construction contrasts radically with the historic character of the nineteenth century warehouse, with the other structures it serves, and with the historic district as a whole. The forms and colors of the new work introduce an appearance incompatible with the commercial and industrial texture of the district. The entrance walls and pavilion, constructed at the edge of the property line, are highly visible at street level and do not relate to the scale and texture of the enveloping district. The excavation at the rear of the courtyard introduces a level one story below the street, which adds a further incongruous note.

In addition, the prominence of the new work serves to diminish the prominence of the principal historic structure to which it is attached. The effect is that the historic building seems an appendage to the new entrance pavilion and stairtower rather than the reverse (see illus. 7). As a result, the project fails to meet the Secretary of the Interior's Standards for Rehabilitation.

Prepared by: Michael Auer, TPS

These bulletins are issued to explain preservation project decisions made by the U.S. Department of the Interior. The resulting determinations, based on the Secretary of the Interior's Standards for Rehabilitation, are not necessarily applicable beyond the facts and circumstances of each case.



1 and 2. Four-story commercial structure before rehabilitation. Vacant lot and buildings at the right and to the rear were also part of the overall project.



3. Entrance pavilion, front wall and stairtower are prominent new site features.



4. Stairtower provides fire exit from building at left.



5. Covered walkway serves as the principal entrance to all four rehabilitated structures.



6. The covered walkway spans a courtyard excavated for new below-grade apartments.



7. The new site work subordinates the independent historic building to a larger composition of radically new and incompatible elements.

Interpreting the Secretary of the Interior's Standards for Rehabilitation

Number: 88-098

Applicable Standards: 2. Retention of Distinguishing Architectural Character (nonconformance)

Subject: CHANGE TO HISTORIC SETTING

Issue: The setting of a historic building can be an important element in defining its historic character. Setting is defined as the relationship of the historic building to adjacent buildings and the surrounding site or environment. Standard 2 of the Standards for Rehabilitation calls for retention of the distinguishing "original qualities or character of a building, structure, or site and its environment," while the Guidelines for Rehabilitating Historic Buildings stress the need to retain "the historic relationship between buildings, landscape features, and open space." This relationship between a building and its setting can be altered drastically by moving other buildings onto the site of a historic structure and by the addition of extensive parking lots and other landscape changes.

Application: A large, finely detailed Neo-Classical mansion, built in 1900 and representing the wealth of prosperous mill managers and the specific contributions of its locally significant owner to the community, was listed individually in the National Register of Historic Places. Although the large lot on which the building stood had been overgrown in recent years, the character of the house as an imposing suburban residence on a spacious site had survived (see illus. 1).

In the process of converting the site into an office condominium complex, another large house, originally located on the adjacent lot with a similar setback and orientation, was moved to what had been the front yard of the individually listed building (see illus. 2, 3 and 4). The moved building was turned to face the 1900 structure. A parking lot with much enlarged street access, including the addition of gateposts from the neighboring property, was constructed between the two buildings (see illus. 5). A second and much smaller building was also moved from the adjacent property and sited at the rear of the listed building.

Although both of the moved buildings were saved from demolition, their relocation in the manner shown here has nearly obliterated the historic setting of the 1900 building. That building appears as a subordinate element in a new composition bearing little relationship to the historic appearance of the property. The central parking lot, furthermore, has become the dominant feature of the site (see illus. 6). The project does not meet the Standards for Rehabilitation.

Prepared by: Michael Auer, TPS, and Amy Schlagel, National Register

These bulletins are issued to explain preservation project decisions made by the U.S. Department of the Interior. The resulting determinations, based on the Secretary of the Interior's Standards for Rehabilitation, are not necessarily applicable beyond the facts and circumstances of each case.

88-098



1. Although the site was overgrown, the character of this 1900 house as a large suburban residence had survived.

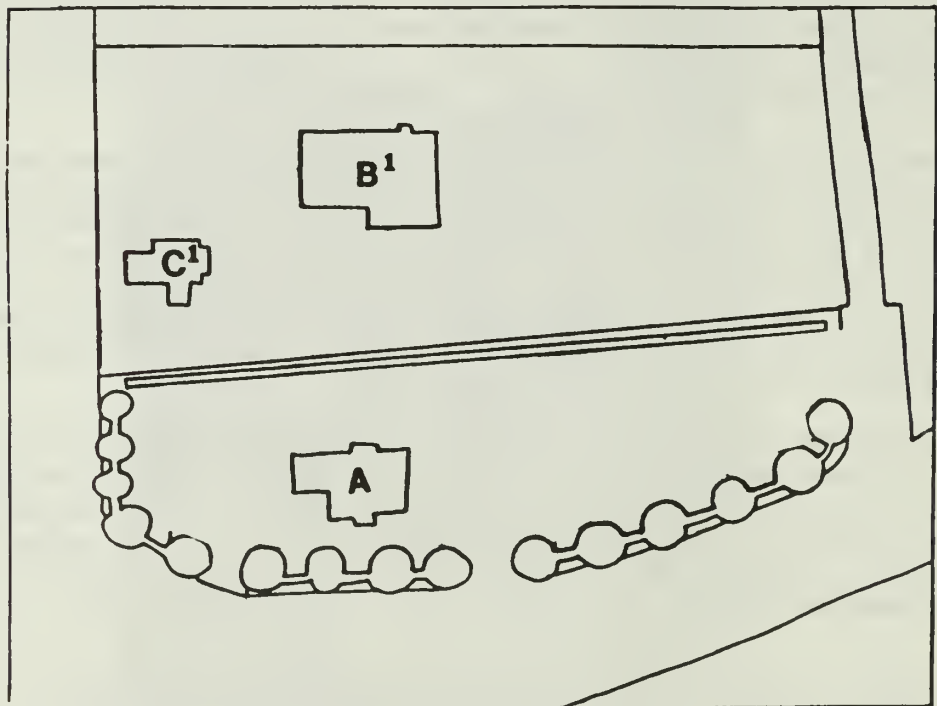

2. Site plan before rehabilitation began. The 1900 house (A) stood alone on its lot. On the adjoining property stood another large house (B1) and a dependent cottage (C1).



3. The front yard of the mansion has been prepared for the relocation of the neighboring house, seen at right.

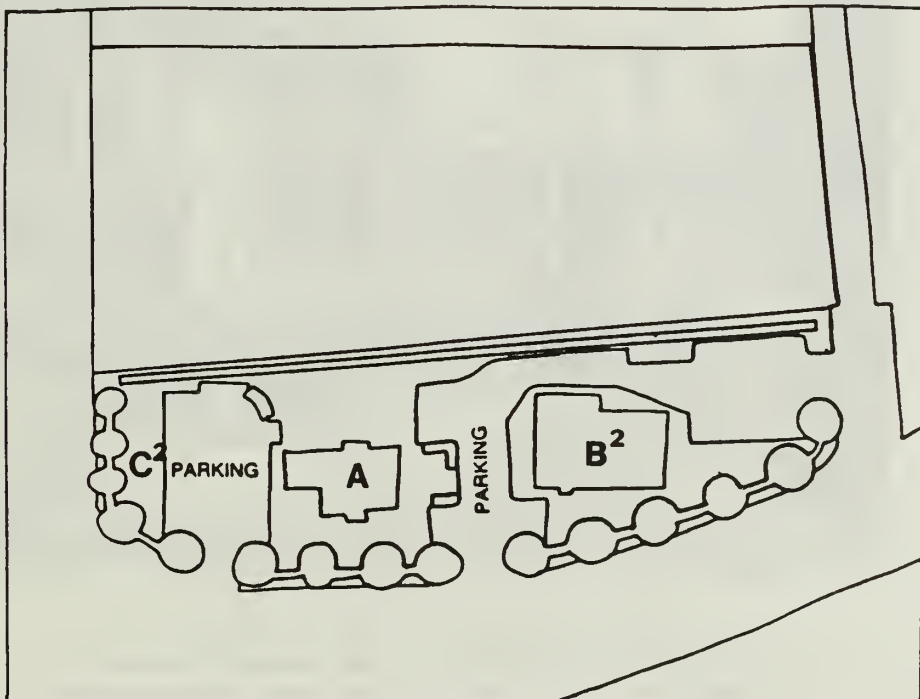

4. Site plan after relocation of buildings. The neighboring house was moved and turned around (B2) to face the 1900 building (A) across a paved parking lot. The cottage associated with the moved house was relocated (C2) behind the 1900 building.



5. Turned 180 degrees, the moved building faces the historic one from a distance of 60 feet.



6. The parking lot completes the drastic alteration of the setting. The second relocated structure is seen through the porte-cochere at left

Interpreting the Secretary of the Interior's Standards for Rehabilitation

Number: 88-099

- Applicable Standards:
2. Retention of Distinguishing Architectural character (nonconformance)
 6. Repair/Replacement of Deteriorated or Missing Architectural Features Based on Historical Evidence (nonconformance)

Subject: SELECTIVE RESTORATION IN HISTORIC INTERIORS

Issue: When rehabilitating historic buildings, changes that have taken place in the course of the history and development of a building and that have acquired significance should be respected. If, however, an earlier period in the history of the building is clearly identified (in the National Register nomination, for example) as being the primary period of historical significance, property owners have the option to restore the building to that period if the restoration can be substantiated by historic, physical or pictorial evidence. The Secretary of the Interior's Standards for Historic Preservation Projects defines restoration as "the act or process of accurately recovering the form and details of a property and its setting as it appeared at a particular period of time by means of the removal of later work or by the replacement of missing earlier work." Sometimes a decision is made by an owner to restore portions of the building to a particular historical period and to rehabilitate the rest of the structure. As a result, a new appearance may be created that never existed historically and does not accurately reflect the history and evolution of the building.

Application: A two-story brick structure, constructed in 1839 as an academy was substantially altered in 1870 and again in 1912 when the building was converted to a residence (see illus. 1). Prior to rehabilitation as a restaurant, the interior of this structure reflected its function as a residence of the early 20th century rather than its original use as a school, with a center stair hall plan, six-panel doors, and bullseye molding around doors and windows. A one-story hipped roof porch supported by cast-iron columns dating from 1870 extended the breadth of the facade, and a two-story brick ell, constructed in 1912 when the academy became a residence, extended from the southeast corner of the main block. The National Register documentation for the historic district in which this building is located cited the academy as being important in the history of education in the town. A decision was made to restore the main block of the building to its appearance as an academy in the 1870's. While this was considered an acceptable approach given the building's significance during that period, the restoration was determined not successful for several reasons.

Features in the main block of the building such as partitions, windows, doors, fireplaces and trimwork dating from ca. 1912 were removed and replaced with replications of the ca. 1839-1870 features in their original locations. The twentieth century center stair (see illus. 2), was removed and replaced with a new stair in an attempt to further match the original configuration of the academy floor plan. Also included in this rehabilitation was the replacement of the front door, and the change in location of the front door and windows to reflect the facade as it appeared between

1839 and 1870. The ca. 1870 porch, however, was retained and preserved, as was the ca. 1912 rear ell addition. Although the new stair was based on scattered ghost marks and fragments of the original stair, there was no evidence of what the original bannister and newel post looked like, and as a result the new appearance is conjectural (see illus. 3). Also conjectural is the design of the new front door which was installed to replace two ca. 1912 doors. The only evidence existing for the front door was three hinges found near the suspected location of the original door.

Other interior features in the main block of the building were not returned to the academy period of the structure. A ca. 1912 door with bullseye molding on the first floor and a ca. 1912 arched opening on the second floor, were retained amidst 1839-1870 details. In addition, all of the 1839 windows were not reinstalled. On the interior, window trim applied over recessed plaster panels was installed in the location of two 1839 windows (one on each floor) to represent their original locations (see illus. 4). Lastly, partitions that had existed on the second floor of the main block from 1839-1912 were not reinstalled, in order to accommodate one large seating area for the restaurant (see illus. 5 & 6). Because only portions of the main block were restored, the work was inconsistent, and the rehabilitation failed to return the significant main block of the building to its historic appearance as an academy.

Selective restoration in this rehabilitation would have been appropriate if the entire 1839-1870 main block of the building, the significant academy structure, had been restored, with the rear ell addition (ca. 1912) being retained and preserved as a representative example of the building's change of use. If evidence did not exist to accurately restore the building to its academy period, retention and preservation of the entire structure as a twentieth century residence would have been acceptable.

Prepared by : Camille M. Martone, TPS

These bulletins are issued to explain preservation project decisions made by the U.S. Department of the Interior. The resulting determinations, based on the Secretary of the Interior's Standards for Rehabilitation, are not necessarily applicable beyond the unique facts and circumstances of each particular case.



Pre-rehabilitation photograph of academy building (as it functioned as a residence).

88-099



2. Circa 1912 stair prior to rehabilitation. Moldings, floor plan, and other detailing are all 20th century.



3. New stair after rehabilitation. Design of stair was not based on historic evidence.

88-099



4. Main dining room in first floor of restaurant after rehabilitation. Note ca. 1912 door and molding remain, and ca. 1839 window

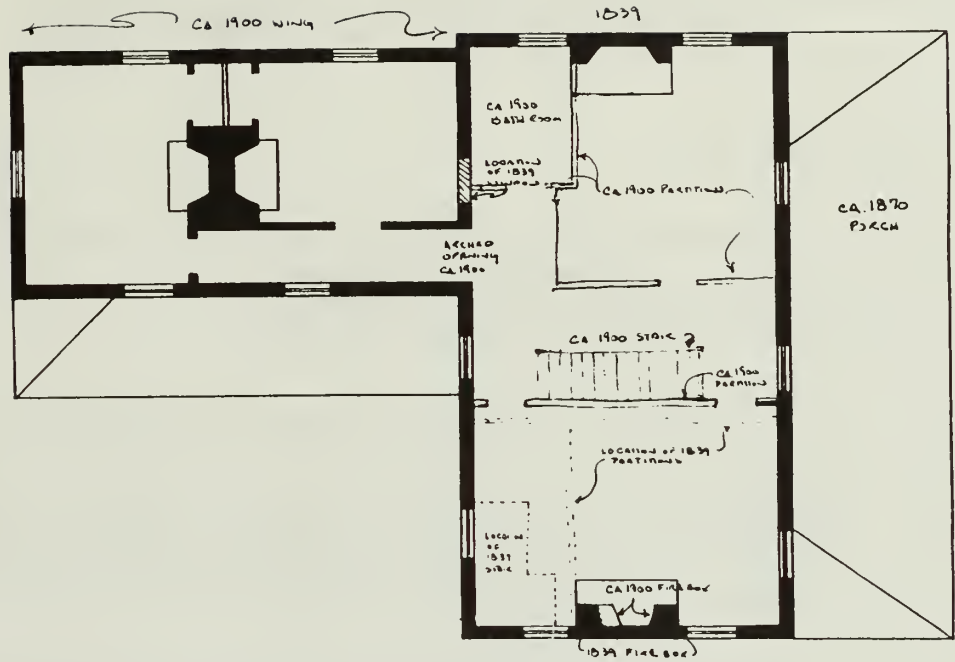

5. Second floor plan prior to rehabilitation.

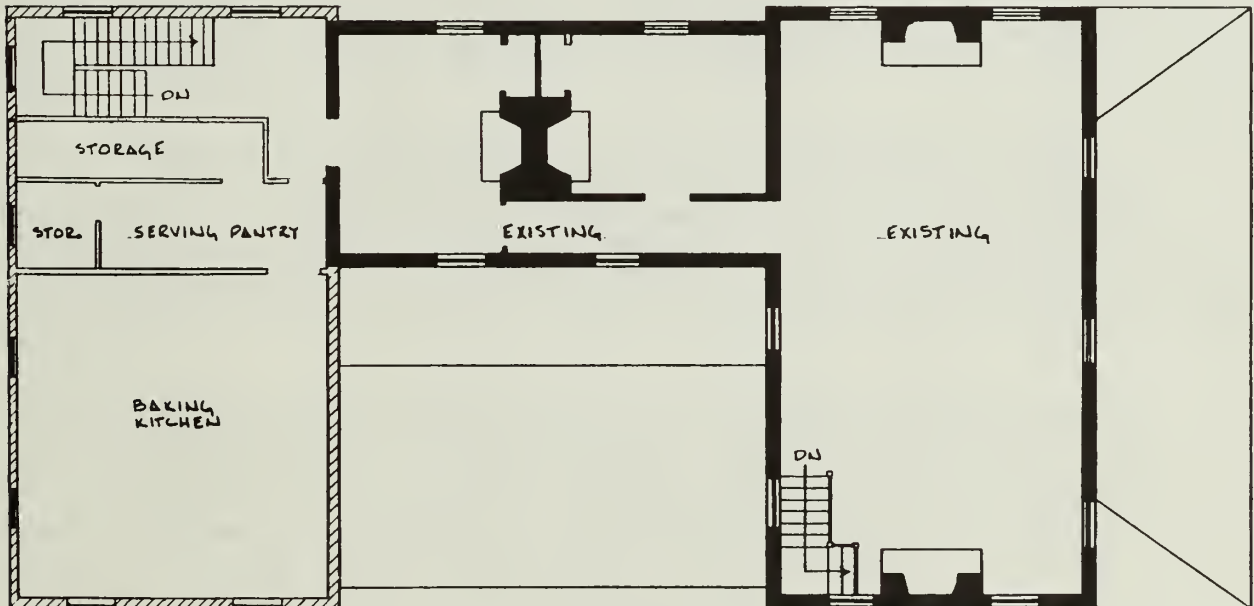

6. Second floor plan after rehabilitation. Note 1839 partitions and window were not reinstalled.

Interpreting the Secretary of the Interior's Standards for Rehabilitation

Number: 88-100

- Applicable Standards:
2. Retention of Distinguishing Architectural Character (nonconformance)
 5. Sensitive Treatment of Distinctive Features and Craftsmanship (nonconformance)

Subject: ALTERATIONS OF FLOOR PLANS AND INTERIOR FEATURES

Issue: In an historic interior, the floor plan, the sequence of spaces, features, and finishes can be important in defining the overall historic character of the building. Their identification, retention, and protection should remain a high priority in a rehabilitation project. Radically changing such elements may result in a loss of historic character.

Application: A three-story school building, with a four-story central bell tower constructed in 1886 as the main school for the town (see illus. 1), was rehabilitated as residential apartments. Around 1938 the building had been converted to pocketbook factory and after 1970 a storage facility. Despite these new uses, the building retained a high degree of integrity, both on the exterior and interior, and was declared a certified historic structure for its contribution to a historic district. The original interior configuration had survived, consisting of a central corridor with a central freestanding stair (see illus. 2), with four classrooms off the hall on each floor. Two end towers also contained stairs and provided separate entrances for boys and girls to the classrooms. Interior trim and detailing that remained intact included beaded board wainscotting in classrooms and halls, and Eastlake-style window and door surrounds. (see illus. 3).

In the rehabilitation of the building to accommodate seventeen apartments, the central-hall plan was obliterated; the central staircase was removed and bathrooms and apartment units were inserted in the space (see illus. 4 & 5). A new east-west corridor perpendicular to the original central hall was installed. Further work included subdivision of classrooms with permanent partitions, furring out the interior face of the exterior walls, and the subsequent covering of significant amounts of wainscotting.

The existing floor plan of this building was part of the building's character with the primary public access to the building through doors in the central tower into a spacious center hall, which in turn provided direct access to the classrooms. In the completed rehabilitation, circulation through the interior spaces has been drastically changed. While the central entrance remains in the same location, access to the building is now through a narrow corridor rather than a spacious hall. The central stair leading to second and third floor classrooms has been removed, and the original four classrooms on each floor have been subdivided. The sense of time and place associated with the school building and how it functioned historically has been diminished. There is no trace of the distinctive floor plan or spacious hallway that once helped define the function and character of this building type.

Another distinctive feature that was characteristic to this building type was the panelled wainscotting found throughout the interior. However in the rehabilitation, the interior face of the exterior walls was furred out and significant amounts of wainscotting were subsequently covered (see illus. 6). This treatment has caused the wainscotting to appear fragmented and dis-continuous. The remaining wainscotting appears to be randomly placed, and together with the significant subdivision of the classrooms prevents a clear understanding of the original classrooms' design and space.

The rehabilitation could have been successful if the original floor plan had been retained and incorporated into apartments without extensive alterations. This floor plan could have lent itself to adaptation to apartments if it had been limited to one apartment per classroom with the retention of the hallway as a shared lobby among residents. However, because of the drastic change to the floor plan, the historic character of the building has diminished, and the important progression or sequence of spaces through the building, as well as distinctive architectural features were lost.

Prepared by: Camille M. Martone, TPS

These bulletins are issued to explain preservation project decisions made by the U.S Department of the Interior. The resulting determinations, based on the Secretary of the Interior's Standards for Rehabilitation, are not necessarily applicable beyond the unique facts and circumstances of each particular case.



Pre-rehabilitation photograph of school building.

12" steel beam



2. Pre-rehabilitation photograph of first floor center stair and hall. This stair was removed in the process of rehabilitation.

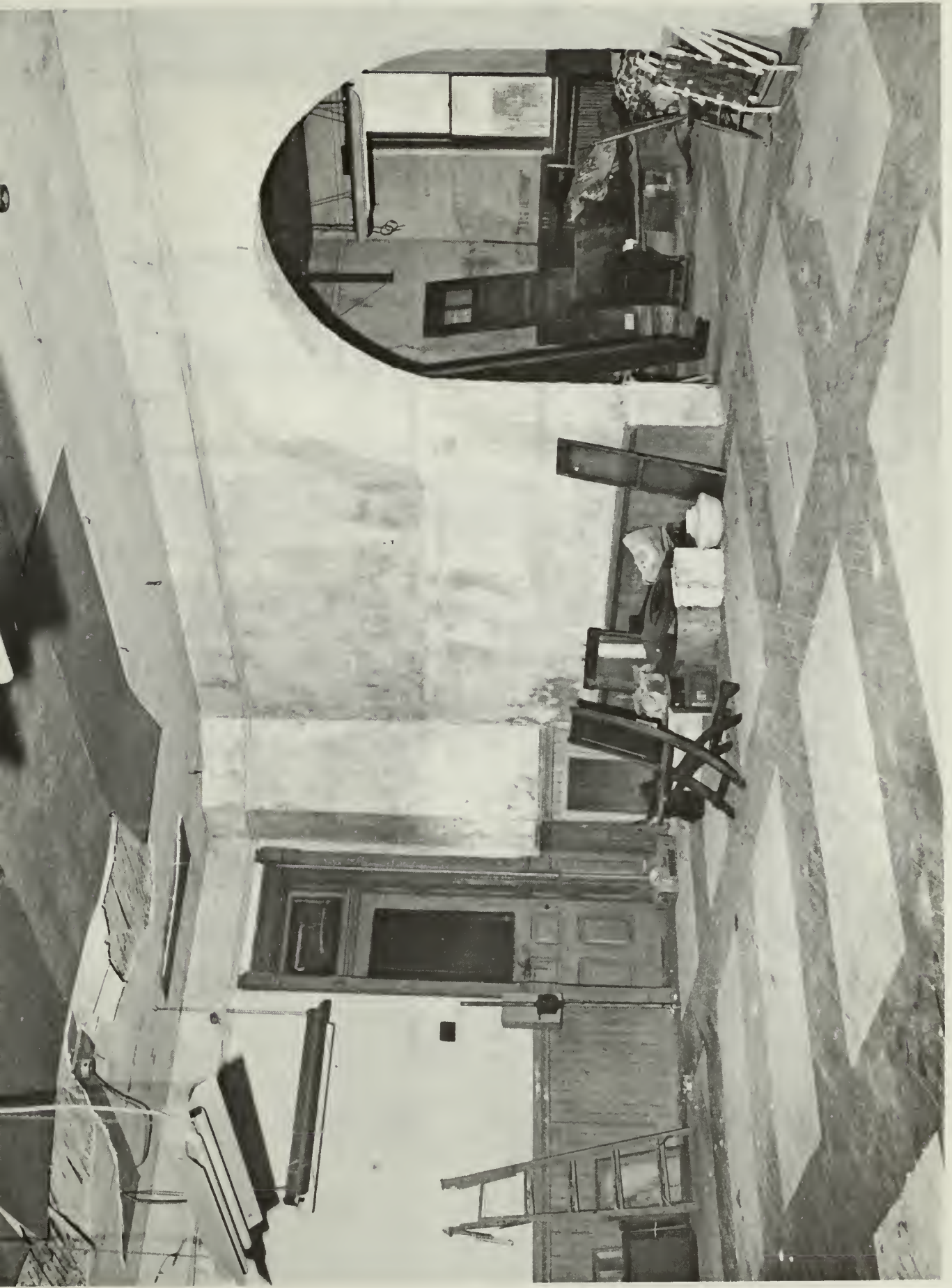

3. View of interior first floor classroom prior to rehabilitation. Arched opening between classrooms was added after original construction.

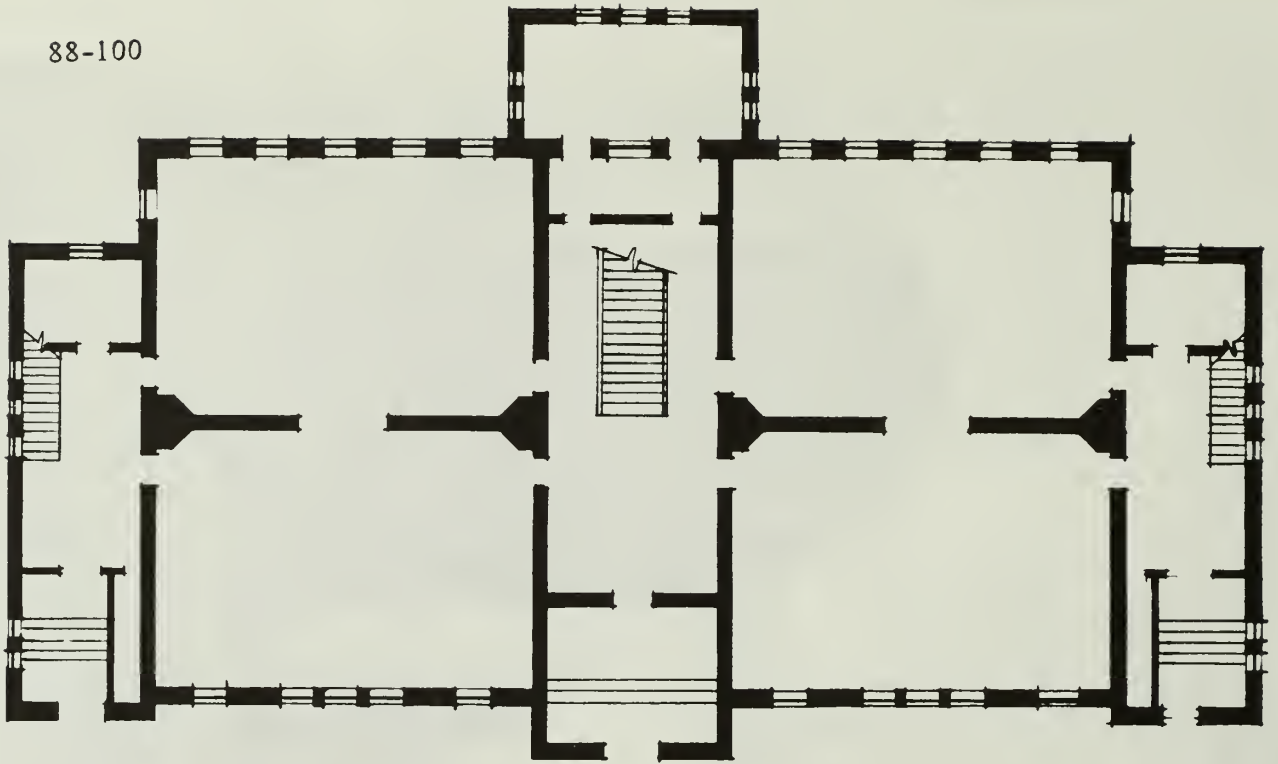

4. Floor plan of first floor prior to rehabilitation.

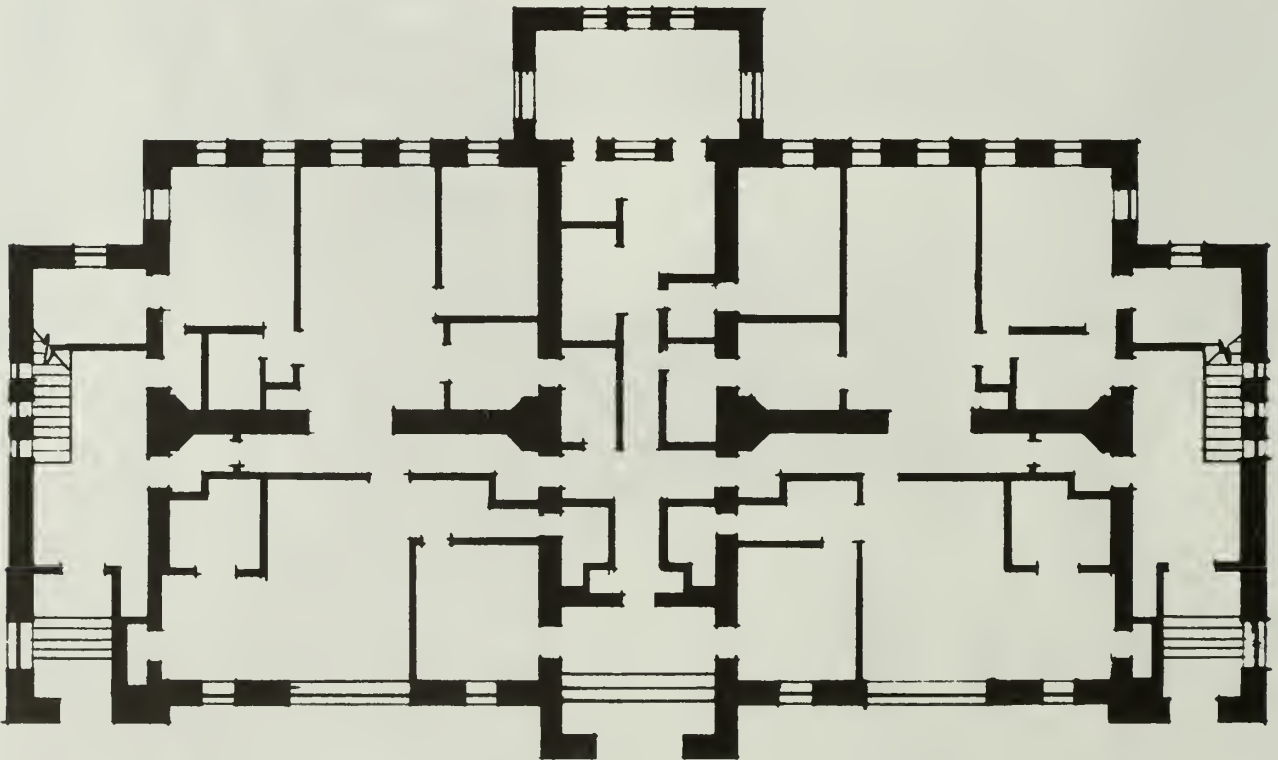

5. Floor plan of first floor after rehabilitation. Classrooms and hallway have been subdivided into apartments.



6. Third floor classroom as modified for apartments in rehabilitation.

Interpreting

the Secretary of the Interior's

Standards for Rehabilitation

Number: 88-101

- Applicable Standards:
2. Retention of Distinguishing Architectural Character (nonconformance)
 5. Sensitive Treatment of Distinctive Features and Craftsmanship (nonconformance)

Subject: REMOVAL OF DISTINCTIVE ARCHITECTURAL FEATURES AND REPLACEMENT WITH INAPPROPRIATE NEW FEATURES

Issue: Interior features in a historic building that are significant in defining the historic character and function of a building need to be retained in the process of rehabilitation. If the interior has been greatly altered over time and documentation indicates that surviving features are severely damaged or deteriorated, flexibility is afforded the owner in making further alterations. New features introduced to the building, however, must be compatible with the scale, design, materials, color, and texture of the surviving interior features. If on the other hand, original interior features have remained relatively intact and are important evidence of the building's history, they should be retained and preserved in situ.

Application: A one-story long and narrow railroad depot with a deeply overhanging hip roof and double-hung wood windows on all sides, built in 1870 in the Queen Anne-Stick style, was rehabilitated into a restaurant (see illus. 1). The depot, which was individually listed in the National Register of Historic Places, had been extensively remodeled in 1891 and retained a high degree of integrity and architectural character of that period prior to rehabilitation. Of significance was the structurally and architecturally intact interior of the depot. Prior to rehabilitation, this modest structure retained virtually all of its historic fabric, including interior spaces, features, and finishes. The waiting room, including the original 5-sided ticket booth, a wooden ceiling with a wide cove cornice throughout, and tongue-and-groove panelling had survived (see illus. 2 & 3).

The majority of the project work on the building's exterior, including window and roof repair, was sensitively accomplished; one exception was the construction of an awkward-looking exterior ramp and fence at the south end. Work on the interior however, involved incompatible alterations to accommodate seating for the restaurant. The ticket booth, a distinctive element that contributed to the definition of the historic function of this train station, was removed and the original ticket window relocated (see illus. 4). Approximately two-thirds of the plank ceiling and cornice, features characteristic of the Stick style, were also removed (see illus. 5), to permit full utilization of the second floor. The Secretary of the Interior's Standards for Rehabilitation require that distinctive features which characterize a building, structure, or site be treated with sensitivity. They also require that the removal or alteration of any historic material or distinctive architectural features be avoided when possible. The removal of these intact features and insertion of new architectural elements greatly impairs the historic character of the structure and violates the Standards.

88-101

The ceiling of the depot which was removed to install a functional second floor above, was replaced with new ceiling joists dropped below the original first floor ceiling (see illus. 5 & 6). The new unfinished and exposed wood joists are not in keeping with the character of the previously finished waiting room. Further compromising the room was the insertion of restrooms and a staircase at one end of the waiting room; two end windows were obliterated and the distinctive waiting room was reduced by approximately 1/4 to 1/3. Although some detailing was retained on the interior, it was extensively reconfigured, and the new features added were incompatible to the building. As a result, the existing 19th century interior lost its integrity and historic character.

Prepared by: Camille M. Martone, TPS

These bulletins are issued to explain preservation project decisions made by the U.S. Department of the Interior. The resulting determinations, based on the Secretary of the Interior's Standards for Rehabilitation, are not necessarily applicable beyond the unique facts and circumstances of each particular case.



1. Railroad depot prior to rehabilitation.



2. Interior view of waiting room prior to rehabilitation. Note wooden ceiling and wide covered cornice.



3. Interior view of ticket booth prior to rehabilitation. This historic feature was removed in the process of rehabilitation.



4. Post-rehabilitation view of waiting room after the removal of ticket booth. Note ticket booth window relocated in new stair wall.



5. Post-rehabilitation view of waiting room. Note the removal of existing ceiling, and the addition of exposed ceiling joists above.



6. Post-rehabilitation view of second floor. Original attic space converted to restaurant space by lowering the ceiling below.

Interpreting

the Secretary of the Interior's

Standards for Rehabilitation

Number: 88-102

- Applicable Standards:
2. Retention of Distinguishing Architectural Character (conformance)
 6. Repair/Replacement of Deteriorated or Missing/Features (conformance)

Subject: REHABILITATING PREVIOUSLY ALTERED INTERIORS

Issue: Rehabilitating a historic building in accordance with the Secretary of the Interior's Standards requires not only that exterior work be carried out with sensitivity, but that interior treatments also be undertaken with equal respect for those significant character-defining features which make it distinctive. Generally this means that the rehabilitation should retain and preserve as much as possible of the original floor plan and spatial configuration, as well as those interior features and finishes that are important in defining the overall historic character of the building.

Some interiors are of such significance that they must be retained almost in their entirety if the building's historic character is to be preserved. However, other buildings, because of unsympathetic uses or other changes over the years, have been reconfigured on the interior and no longer contain notable interior features or finishes that must be preserved. When rehabilitating buildings where rooms have been greatly reconfigured, walls torn out, and doors and trim removed, the owner is generally afforded some flexibility in making further alterations.

Application: A three-story, brick rowhouse built in 1893 was rehabilitated for residential use into three apartments (see illus. 1). Originally constructed as a single-family house, and later altered for office use, the building was vacant and had already been partially gutted by the time the new owner purchased it for rehabilitation. The previous owner had removed wall partitions and, leaving wall studding on the first floor only, stripped the plaster from the ceiling joists and removed the one remaining mantel, and most of the decorative door, window and floor trim (see illus. 2-3). The staircase, running from the 1st to 3rd floors along one wall survived; most of the woodwork which had been removed, had not been thrown away but was found later by the new owner piled on the third floor. The second and third floors had been stripped of their wall studding and were essentially open spaces. Although the walls were gone on the first floor, the studding still remained between what was originally the front and the rear parlor, and between the front parlor and the stairhall.

The spaces and basic configuration of the stairhall and front and back parlors, were retained in the rehabilitation, although some of the rooms were converted to new uses necessitated by the rearrangement of the first floor into a two-bedroom apartment unit (see illus. 4). As part of the rehabilitation, the double-door-sized opening between the front and rear parlors was permanently walled-off to provide a bathroom and closets for the apartment. Although this is

generally not a recommended rehabilitation treatment, in this case it was minimally acceptable because it did not destroy an original or historic spatial sequence. That had already been lost when the previous owner removed the walls which had traditionally defined these spaces.

Despite the existing shell-like condition of most of the interior, the new owner restored the historic staircase (although code compliance necessitated several changes) and repaired and reused the woodwork and trim that had been removed by the previous owner. Because the rehabilitation also included a careful restoration of the exterior, which was the major remaining character-defining aspect of the building through which it contributed to the significance of the historic district, the rehabilitation was certified.

Prepared by: Anne Grimmer, TPS

These bulletins are issued to explain preservation project decisions made by the U.S. Department of the Interior. The resulting determinations, based on the Secretary of the Interior's Standards for Rehabilitation, are not necessarily applicable beyond the facts and circumstances of each case.



1. The exterior of this 1893 brick rowhouse is its primary character-defining feature through which it contributes to the historic district.

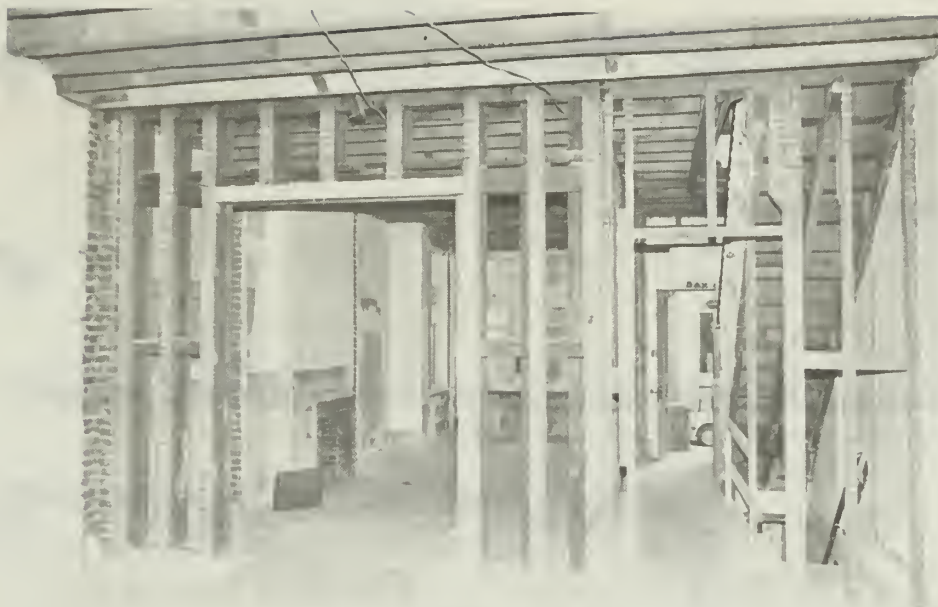

SECOND FLOOR

2. The interior of the house after it had been "gutted" by the previous owner. The photographs of all 3 floors are taken from the same location on each floor, and show views toward the front of the house. The new owner was able to repair and reuse wood trim (here, shown piled behind the stairs on the third floor), that had been removed by the previous owner.



THIRD FLOOR



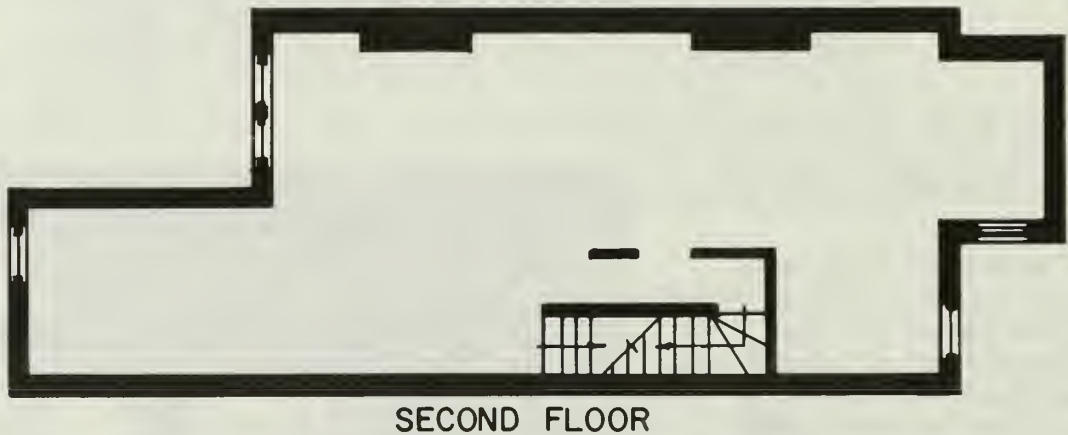
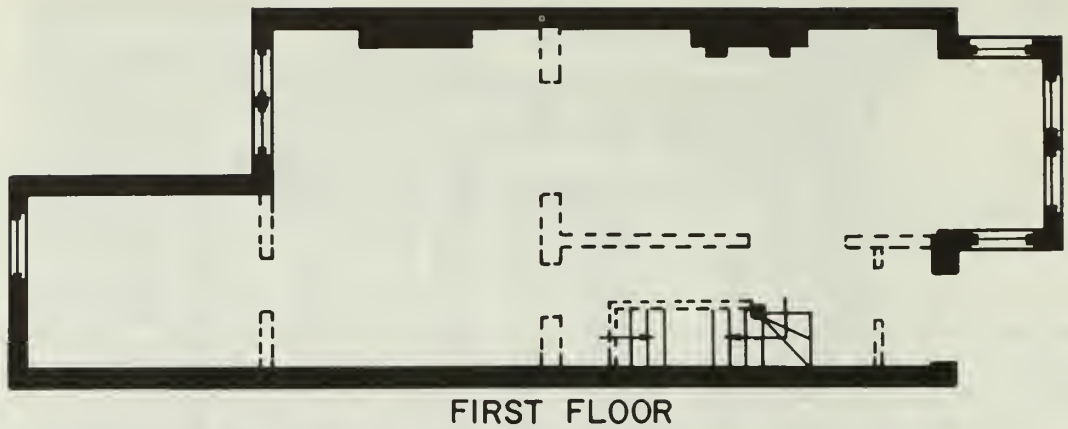

3. Floor plans of the interior prior to rehabilitation. The fireplaces had been removed during previous renovations. Dashed lines represent open stud walls.

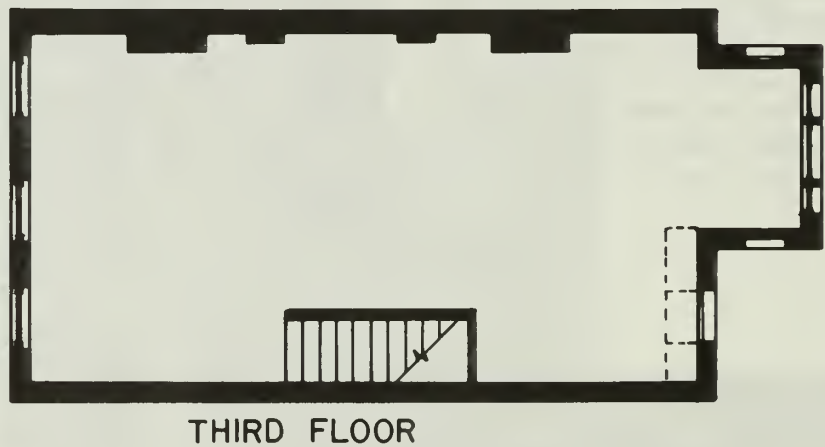

4. The redesigned first floor after rehabilitation showing retention of the basic spaces and stair-hall configuration.

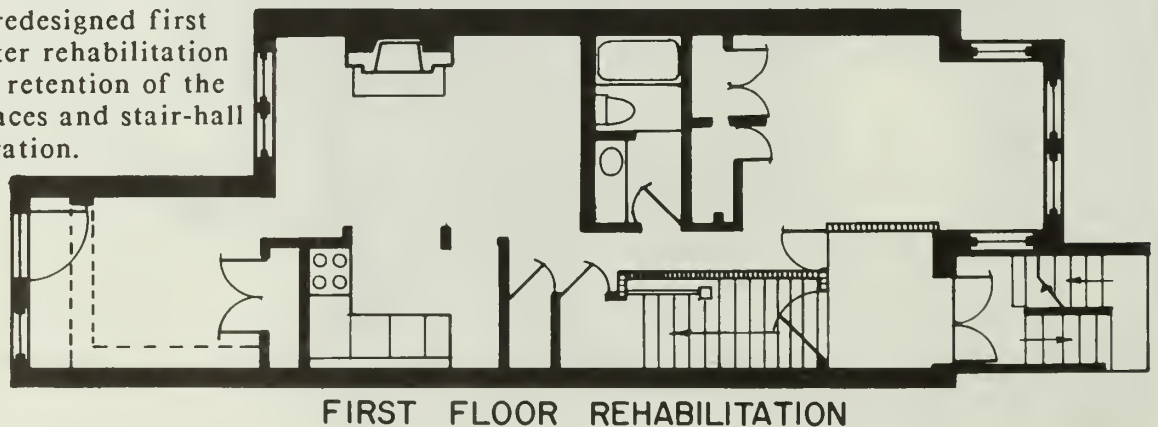

Interpreting the Secretary of the Interior's Standards for Rehabilitation

Number: 88-103

- Applicable Standards:
2. Retention of Distinguishing Architectural Character (nonconformance)
 9. Compatible Design for New Alterations/Additions (nonconformance)

Subject: ADJACENT NEW CONSTRUCTION

Issue: The Secretary of the Interior's Standards for Rehabilitation govern new additions to historic structures undergoing rehabilitation work. They also apply to new construction adjacent to historic structures when the new construction is placed on the same property on which the historic structures stand. Furthermore, the Guidelines for Rehabilitating Historic Buildings recommend "designing... adjacent new construction which is compatible with the historic character of the site and which preserve[s] the historic relationship between a building or buildings, landscape features, and open space." Adjacent construction that impairs the historic character of a historic building may render the rehabilitation project ineligible for historic preservation tax incentives even if the work completed on the historic structure itself is otherwise acceptable.

Application: A college campus that formerly functioned as a Roman Catholic seminary was rehabilitated into an extended-care retirement community. Historically the main structures of the educational complex were aligned across a formal, terraced platform, overlooking the expansive lawns and playing fields that separated the institution from the surrounding community. This linear arrangement of the principal campus buildings conveyed the impression of an institution proclaiming its presence to the world, while retaining a certain detachment from it (see illus. 1). The overall project included the conversion of several historic classroom buildings and dormitories into apartment buildings. As part of the overall, massive project, three new apartment buildings were constructed, grouped in front of an existing structure (see illus. 2 and 3).

The rehabilitations of all of the historic structures met the Standards for Rehabilitation, with the exception of a dormitory constructed at one end of the line of principal buildings. (This building, although constructed in the mid-twentieth century, was determined to contribute to the significance of the historic district as a physical expression of the profound changes undergone by the institution in its last decades.) Both by its location and its shape, the structure serves as a terminus to the row of buildings to which it was added. The grouping of three newly built structures around the dormitory overwhelms the latter, severing its visual connection to the row of historic buildings. As a result, the end building is no longer visible from the main entrance to the campus, from what remains of the lawn, or from any other principal vantage point in front of the buildings.

Although the new construction is generally sympathetic to the neighboring historic buildings in size, scale, color, materials, and design, it fails to meet Standards 2 and 9 of the Standards for Rehabilitation because of its impact on the site and environment of the building it obscures.

Prepared by: Michael Auer, TPS

These bulletins are issued to explain preservation project decisions made by the U.S. Department of the Interior. The resulting determinations, based on the Secretary of the Interior's Standards for Rehabilitation, are not necessarily applicable beyond the unique facts and circumstances of each particular case.



1. The alignment of the principal structures overlooking a formal terrace, expansive lawns and playing fields was a principal feature of the historic campus.



2. Aerial view of campus. The three new buildings at right visually sever the end building from the rest of the row, thereby drastically diminishing its historic character.

Interpreting the Secretary of the Interior's Standards for Rehabilitation

Number: 88-104

- Applicable Standards:
2. Retention of Distinguishing Architectural Character (nonconformance)
 5. Sensitive Treatment of Distinctive Features and Craftsmanship (nonconformance)

Subject: INAPPROPRIATE EXTERIOR PAINTED FINISHES

Issue: Paint or paint color can be an important factor in defining the character of a historic building. Painting a building that has never been painted, or removing paint from a building that has traditionally been painted is never a recommended rehabilitation treatment, because either of these treatments can change a building's appearance to one that is at odds with its historic character. Likewise, when repainting a historic building that is already painted, the new color should generally be close to the original, as well as historically appropriate to the building, and the historic district in which it is located.

Application: A derelict, two-story, reinforced concrete, stucco apartment building built in 1941 was rehabilitated for apartment use. It is a U-shaped structure entered through a deep central courtyard, and although quite plain, the building is a characteristic example of the Moderne style (see illus. 1). The exterior is accented by rather simple architectural details, which include bulls-eye windows, "eyebrow" window canopies, geometric raised panels, and like many other buildings in the historic district, features decorative panels of local stone (see illus. 2).

As part of the rehabilitation, the exterior stucco, which had been repaired and patched as necessary, was painted as the owner himself stated, in a "fanciful and sportive manner." Prior to rehabilitation, the building had been painted beige with a few of its decorative features highlighted in a darker brown. After rehabilitation, the wall surfaces of this building had been transformed by the application of numerous colors and decorative painted and patterned surfaces (see illus. 3-5). Wall surfaces were painted in alternating horizontal bands of aqua, yellow and pink, and projecting horizontal overhangs and the raised geometric panels were boldly outlined in black. Most notable was the use of paint to create contemporary stylized patterning, exaggerated illusionistic stone textures on door surrounds and above door panels, and a "cracked-tile" pattern above second-story stairwells and on planters surrounding the base of the building.

This apartment building is typical of the Moderne style, and as such is characterized by simplicity of materials, flat roofs, horizontal unbroken lines, use of pure colors and honesty of materials. It is the building's plain, monochromatic wall surfaces combined with only a few simple geometric decorative features that define its character. The application of these exuberant painted finishes during the rehabilitation distorted these features so characteristic of the style, thus confusing the historic stylistic identity of the building.

Consequently, as no evidence was presented to indicate that this type of exterior decorative painting had ever existed on this particular building, nor indeed on any building located in the historic district, it was determined that the decorative painted abstract patterns and faux finishes applied during the rehabilitation were inconsistent with the historic character of the building, and the historic district. The plain, unpatterned aqua, yellow, and pink colors on the walls were not considered objectionable, or in violation of the Standards, although it is most unlikely that they would have existed historically either in such a combination, or in such intense colors.

88-104

In order to receive the tax credits, the owner agreed to paint over the patterned finishes on the walls in solid white and the planters in solid black, thereby bringing the rehabilitation into conformance with the Standards and making it consistent with the historic character of the property and the historic district.

Prepared by: Anne E. Grimmer, TPS

These bulletins are issued to explain preservation project decisions made by the U.S. Department of the Interior. The resulting determinations, based on the Secretary of the Interior's Standards for Rehabilitation, are not necessarily applicable beyond the unique facts and circumstances of each particular case.



1. The primary entrances to this early 1940s Moderne apartment building are located in the courtyard of the U-shaped structure. Note the overall plainness of the building before rehabilitation, which is highlighted only by horizontal banding and raised geometric panels.



2. The street elevation of the building where patch repair work has already begun shows the decorative panels of local stone under the second story windows at either end of the building.



3-5. After rehabilitation the character of the building has been greatly changed by the application of a variety of decorative painted finishes, in particular the "faux" stone surfaces around doors, the contemporary patterned design used above doors and on balconies, and the "cracked tile" pattern on the planters that surround the building.



Interpreting the Secretary of the Interior's Standards for Rehabilitation

Number: 88-105

- Applicable Standards:
2. Retention of Distinguishing Architectural Character (nonconformance)
 4. Retention of Changes Which Have Acquired Significance (nonconformance)
 6. Repair/Replacement of Deteriorated or Missing Evidence (nonconformance)

Subject: REMOVAL OF EXTERIOR FEATURES WHICH DEFINE HISTORIC USE

Issue: Even when it is not possible to establish the original appearance of an architectural feature which has been replaced during the life of a building, the very presence of the feature in an altered form may be important in understanding the historic function or historical evolution of a building. According to the Secretary's Standards, if the feature is deteriorated or does not comply with building codes, all attempts should be made to repair the feature that exists. Attempts to reconstruct such a feature without physical or photographic evidence may raise concerns about the appropriateness of a replacement; however, when the feature has served in the same location throughout the building's history, and is important to an understanding of the building's historic use, retention or suitable replacement of the existing feature should occur. Complete removal of the replacement feature with no effort toward retention would place the project in violation of Standards 2, 4 and 6.

Application: In the conversion of an 1889 two story, balloon frame building to professional office space, a highly visible exterior wood staircase which had formerly accessed the second floor was removed (see illus 1 and 2). The building, located in a district of residential and small commercial structures, had served as a store on the ground floor with separate living quarters above. The staircase had originally allowed separate entry to the second floor, and thus reinforced the functional independence of the two floors.

The existing staircase was constructed within the last fifteen years; no remnant of the original feature had survived to guide replication and photographic documentation was unavailable. In view of the Standard's cautions against reproductions which are purely conjectural, the owner maintained that any attempt to reconstruct a staircase would misrepresent the original type. Because the narrow width and deteriorated condition of the staircase made it undesirable to retain, the decision was made to remove the staircase entirely with no attempt at reconstruction.

The project was determined not to meet the Secretary's Standards for Rehabilitation because some form of staircase had always served the second floor of the ell and it was felt that the staircase should have been retained or rebuilt. Furthermore, the staircase had been cited as a character-defining element representative of commercial vernacular architecture in the district. Without a staircase to access the second floor of the ell, the historic independence of the living quarters is no longer evidenced and the ell is represented as a single unit.

The project would meet the Standards if the staircase were reinstated, thus recapturing the historic division between the first and second floor living quarters.

Prepared by: Lauren McCroskey, TPS

These bulletins are issued to explain preservation project decisions made by the U.S. Department of the Interior. The resulting determinations, based on the Secretary of the Interior's Standards for Rehabilitation, are not necessarily applicable beyond the unique facts and circumstances of each particular case.



1. This view shows the exterior staircase in place before rehabilitation. Although this staircase was a replacement of the original, the feature was significant because it had remained in the same location and because it announced a separate use and function for the second floor of the ell.



2. With the removal of the staircase there is no longer an indication of the second floor's independence from the first. The two floors of the ell addition appear to be functionally integrated.

Interpreting the Secretary of the Interior's Standards for Rehabilitation

Number: 88-106

- Applicable Standards:
2. Retention of Distinguishing Architectural Character (nonconformance)
 9. Compatible Design for New Alterations/Additions (nonconformance)

Subject: INCOMPATIBLE ROOFTOP ADDITIONS

Issue: When rehabilitating a historic building for a new or continued use, it may be necessary to expand the historic building somewhat to meet new functional requirements or to make the project economically viable. New additions to historic buildings located in urban areas frequently take the form of rooftop additions because of higher property costs or limited availability of land on which to expand. While it is always preferable to choose the new use to fit the size of the existing historic building, the Standards allow the construction of new additions if they do not destroy significant historic or architectural fabric, and if their design is compatible with the size, scale, color, material and character of the property and the neighborhood. Compatible rooftop additions should be subordinate to, and clearly differentiated from, the historic building; not all historic buildings can be enlarged in a manner that is consistent with the Standards, whether for reason of size, siting or location within a historic district. The Guidelines for Rehabilitating Historic Buildings recommend that new rooftop additions be designed so that they are inconspicuous from the public right-of-way, are set back from the front wall plane of the building, and do not damage character-defining features of the historic building. A proposed rooftop addition that violates any of these principles generally would not meet the Standards.

Application: A small, two-story commercial building originally constructed in 1891 as a law office was rehabilitated for residential use. Located on a hill in the business district of a small rural town, this semi-detached brownstone structure almost completely covered its building lot, and its unattached side wall abutted a steep hill, with space for only a narrow service walkway providing access to the rear of the building (see illus. 1). Despite the fact that the entire two floors of the building were utilized for its conversion into a single-family residence, the owner felt that the existing space was inadequate, and accordingly engaged the project architect to design a new rooftop addition. The new one-story addition, approximately 10' x 16', was clad in wood and featured a large brick chimney on the primary elevation. Although set back more than halfway from the front of the historic building in an attempt to minimize it, the new addition is still highly visible within the historic district (see illus. 2-3). This is due in part to its size which is almost one-half the size of the historic building, as well as to the fact that the building itself is highly visible within the town and historic district because of its location on a hillside.

88-106

Because the rooftop addition is too large, and its proportions too heavy for such a modest-sized building, the rehabilitation was denied certification. (The new awning over the front door was also cited as violating the Standards because its size and proportions intrude on the simple classicism of the facade.) While the rooftop addition is not particularly noticeable from many points within the historic district, it is very visible from the main intersection nearby. It is also extremely visible from the historic district boundary up the street from the building. This is the first impression one receives of the historic district when entering the town from this point, and it includes an important scenic view which encompasses much of the district as well as the river and hills beyond.

Prepared by: Anne Grimmer, TPS

These bulletins are issued to explain preservation project decisions made by the U.S. Department of the Interior. The resulting determinations, based on the Secretary of the Interior's Standards for Rehabilitation, are not necessarily applicable beyond the unique facts and circumstances of each particular case.

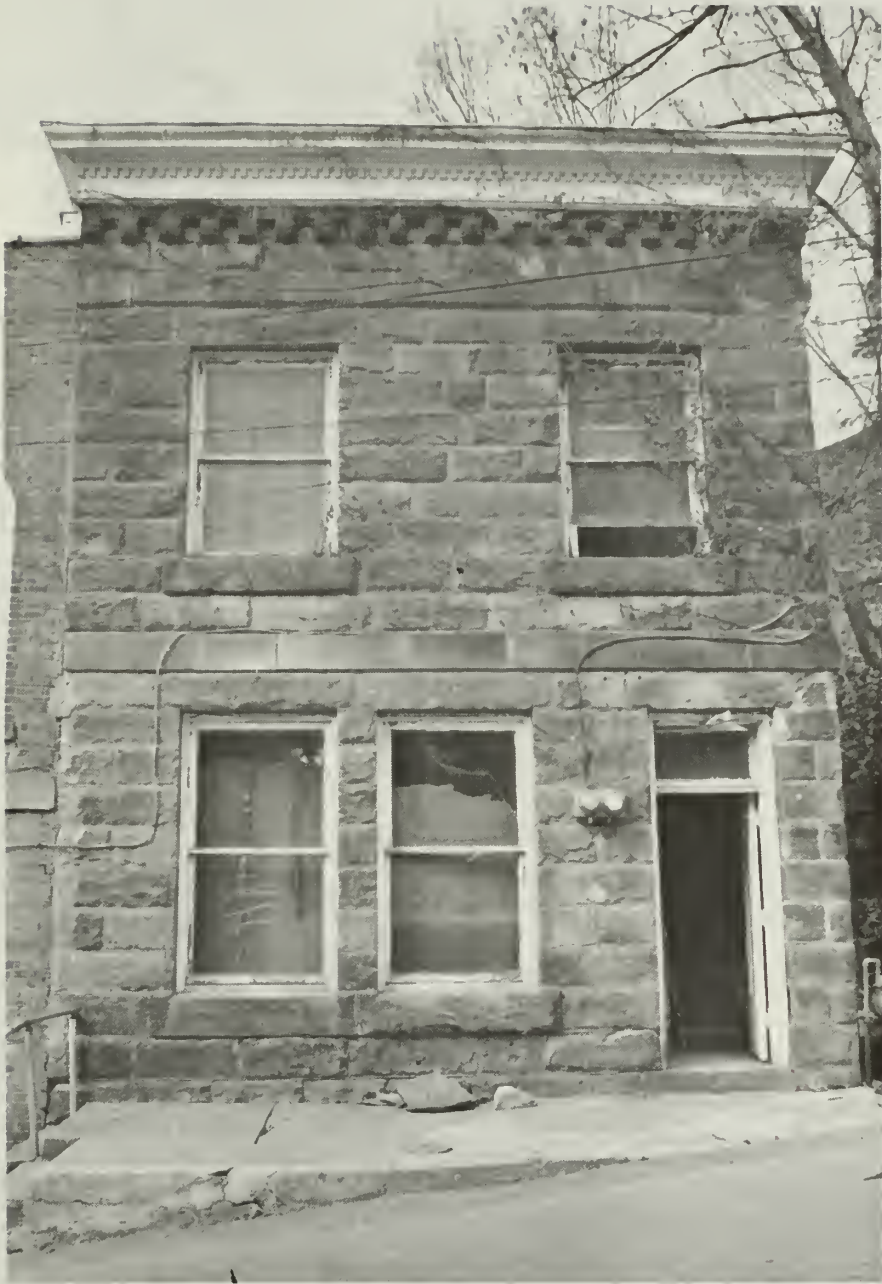

1. This small, semi-detached building was constructed in 1891 as a law office. A narrow walkway to the rear separates the building from the steep hill that abuts it on the right.



2-3. After rehabilitation, the new rooftop addition is highly visible within the historic district, both from below the building at the main intersection at the foot of the hill, and from above the building higher on the hillside.



Interpreting the Secretary of the Interior's Standards for Rehabilitation

Number: 88-107

- Applicable Standards:
2. Retention of Distinguishing Architectural Character (nonconformance)
 3. Recognition of Historic Period (nonconformance)
 6. Repair/Replacement of Deteriorated or Missing Features Based on Historic Evidence (nonconformance)

Subject: ADDING DETAILS WHICH MISREPRESENT A BUILDING'S HISTORIC APPEARANCE

Issue: Owners are often tempted to embellish simple, unadorned facades with high style details, or features borrowed from a different building epoch. If architectural details are added to a facade it is necessary to establish that the features existed together historically on the facade. Undocumented and conjectural changes create a false sense of historical development and are contrary to the Secretary's Standards for Rehabilitation.

Application: In a historic district of vernacular wood frame dwellings, the main facade of a small, single story, simply detailed 1900 building was elaborated with details suggesting the Greek Revival style (see illus 1.) Triangular pediments were added to the window heads, and simple turned posts were replaced with square, Doric posts (see illus 2.) The resultant changes undermined the vernacular simplicity of the Victorian structure. Although buildings within the historic district built about the same time were fitted with Greek Revival details, they were without exception larger, more imposing structures. No other authentic examples of modest, similarly adorned structures could be found. However, even if such examples could be cited, the evidence would not prove that this building ever had these particular features.

The use of unprecedented details on this small facade is also historically and visually improper because the proportions of the new features create awkward junctures with the existing cornice. For example, the capitals of the posts are improperly scaled and project beyond the gable soffit (see illus 3.) The building's new presentation as a Greek temple is also unsuccessful due to the lack of entablature and requisite Classical cornices and moldings that would normally be found in the overlying gable of a true Greek Revival building.

It is not advisable to impose a new stylistic identity onto a facade since attempts will most likely confuse the historic appearance of the building. Although an exterior of any size may lack elaborate detailing and texture, it is important to retain the simplicity which defines the building, realizing that historic character may be expressed only by the few modest details that exist. In this example, violation of the Interior's Standards occurred because the added decorative features caused the removal of historic materials and because the building was given an appearance conflicting with its historic one. By removing the added features and reinstalling the original posts, the visual appearance of the porch and windows can be readily retrieved.

Prepared by: Lauren McCroskey, TPS

These bulletins are issued to explain preservation project decisions made by the U.S. Department of the Interior. The resulting determinations, based on the Secretary of the Interior's Standards for Rehabilitation, are not necessarily applicable beyond the unique facts and circumstances of each particular case.



1. Simple turned posts and plain windows were the only expressive details of the vernacular frame building.



2. The dramatic shift in appearance from a vernacular structure to a higher style building is achieved with Greek Revival posts and triangular window pediments. The building was not originally fitted with these details, nor is there any occurrence of these features on a facade of this size within the district.



3. Not only have the added features created a non-historic appearance for the facade, but the size of the new capitals does not conform to the narrower dimensions of the overlying gable and causes an awkward overlap of the cornice. Compare with the photograph taken before rehabilitation which reveals the compatible proportions of the turned posts and the gable it supports.

Interpreting the Secretary of the Interior's Standards for Rehabilitation

Number: 88-108

Applicable Standard: 2. Retention of Distinguishing Architectural Character (nonconformance)

Subject: INAPPROPRIATE DROPPED CEILINGS

Issue: Dropped ceilings are often installed in historic buildings to cover up materials in need of repair, to reduce energy costs, and to provide an enclosure for HVAC ducts and lighting. However, they are generally not appropriate for historic buildings. Contemporary dropped ceilings can diminish the architectural character of a building in a number of ways. First, they often destroy or obscure architectural ornamentation. Decorative details such as plaster cornices, ceiling medallions, and picture molds are frequently removed or damaged during installation of dropped ceilings, while other historic features such as exposed beams are simply concealed. Lowered ceilings can also have the effect of altering and, in many cases, radically changing room proportions. After a dropped ceiling is inserted, doorways, windows, and other openings can appear to "crowd the ceiling." Finally, since dropped ceilings are often visible from the outside, they can also adversely affect the exterior of the building as well as the interior.

In some cases, however, lowered ceilings may be acceptable: where distinguishing historic features and details would not be lost, where altering room proportions does not change the building's overall historic character, and where the new ceilings do not extend so close to windows as to be prominent from the exterior.

Application: The subject building is a ca. 1890 two-story brick residence located in a turn-of-the-century residential and commercial historic district. In converting the residence into three floors of offices, the owner introduced dropped ceilings in the all primary spaces on the first floor with the exception of the central hall.

Originally, the house featured generous 12' unornamented plaster ceilings on the main floor (see illus. 1), an important characteristic of its age and style. To conceal a new HVAC system, dropped ceilings were installed at a height of 10'. (Typically, the HVAC would be installed in the basement of this building type, but the owner elected to use it for office space, and existing headroom was already limited.)

The contemporary ceiling installed drastically diminishes the historic appearance of the primary rooms (see illus. 2). The fluorescent lighting, dark grid lines and uneven texture of the acoustical tile are not consistent with the building's historic character. It assumes a visual prominence lacking in the original.

The project did not retain the architectural character and therefore failed to meet the Standards for Rehabilitation. In this particular case, there was no permanent damage to the historic materials, so the rehabilitation could potentially meet the Standards if the owner were to install a plasterboard ceiling more consistent with the original room proportions, preferably at the minimum required clearance for the HVAC system. One method to better integrate HVAC systems is the use of wall and ceiling chases. Failure to minimize the impact of the HVAC system and dropped ceiling may violate Standard 2.

Prepared by: Michael Auer and Neal A. Vogel, TPS

These bulletins are issued to explain preservation project decisions made by the U.S. Department of the Interior. The resulting determinations, based on the Secretary of the Interior's Standards for Rehabilitation, are not necessarily applicable beyond the unique facts and circumstances of each particular case.



1. The only primary space on the first floor left unaffected after rehabilitation was the central hall, shown here with its original ceiling height and column divider.



2. This view shows the distracting metal grid and ceiling illumination of the new dropped ceiling.

CUMULATIVE INDEX

Volume 1: 001-043

Volume 2: 044-075

Volume 3: 076-108

Abrasive Cleaning

009, 039

Additions to Buildings

See Also: Greenhouses

New Construction, Adjacent

Storefronts

Demolition of Additions

016, 018, 045

New Additions

010, 022, 026, 027, 028, 034, 037, 045, 051, 058, 072, 075, 079, 085, 091, 095, 097

Rooftop Additions

034, 048, 051, 060, 071, 074, 083, 106

Administrative Issues

See: Previous Owner

Air Conditioning

014

Aluminum Siding

See: Artificial Siding

Arcades

030

Artificial Siding

005, 006, 070

Atrium

048, 093

Awnings

079, 106

Balconies

See Also: Porches, Galleries

048, 077

Brick

Mitigating damage of abrasively cleaned masonry

009

Painting previously unpainted brick

011, 029

Removing interior plaster to expose brick

013

Brownstone

See: Sandstone

Building Codes

032, 037, 059, 081

Ceilings

See: Interior Spaces, Alterations

Chemical Cleaning

063

Cleaning, Damaging Methods

See: Abrasive Cleaning
Chemical Cleaning

Codes

See: Building Codes

Complexes

See: Demolition, Buildings within complexes

Courtyards

097

See Also: Atrium

Cupola

078

Decks

See: Porches

Demolition

See Also: Interior Spaces and Features, Alteration
Buildings within complexes

012, 041, 043

Demolition/alteration of non-original features that have achieved significance
016, 018, 027, 041, 073

Significant fabric and features

032, 039, 048, 072, 076, 082, 084, 093, 100, 101, 105, 107

Deteriorated Buildings, Features and Materials, Repair versus Replacement

029, 031, 038, 040, 042, 043, 054, 055, 056, 064, 067, 069, 086, 087, 088, 089, 090

Doors and Entrances

See Also: Interior Spaces and Features, Alteration

New

029, 047, 049, 050, 077, 094, 097

Removal or replacement of entrance

004, 015, 025, 032, 045, 049, 050, 061, 067, 085, 105

Elevator

059

Entrances

See: Doors and Entrances

Environment

See: Setting

Exterior Surfaces

See: Artificial Siding

Brick

Paint, Removal of

Replacement Materials

Sandstone

Wood

False Fronts

See: Surface Material, Nonhistoric

Fireplaces

See: Interior Spaces and Features, Alteration

Floor Plans, Changes

019, 020, 026, 051, 054, 065, 076, 080, 081, 082, 084, 092, 093, 100, 102

Galleries

See Also: Porches

New construction

008, 078

Gardens

See: Setting

Greenhouse Additions

007, 022, 045, 091

Historically Inappropriate Alterations and Additions, Construction of

See Also: Brick, Removing interior plaster to expose brick

004, 005, 008, 018, 024, 029, 078, 085, 107

Insulation, Urea-formaldehyde Foam

023

Interior Spaces and Features, Alteration

See Also: Floor Plans, Changes

017, 019, 020, 024, 047, 054, 059, 065, 066, 076, 080, 081, 082, 084, 093, 099, 100, 101, 102, 108

Light Shaft

081

Limestone, Replacement

055

Moved Building

098

New Construction, Adjacent

See Also: Additions to Buildings

Greenhouses

Historically Inappropriate Alterations

Infill Construction

Porches

Roof Alterations

Setting

Storefronts

002, 095, 103

Paint

See Also: Abrasive Cleaning
Inappropriate Decorative Schemes
104

Mitigating damage to exterior by painting
009, 042

Painting previously unpainted surfaces
011, 029

Retention of unpainted surfaces after paint removal
036, 039

Pedestrian Bridges

075

Plan, Changes to

See: Floor Plans, Changes

Plaster, Removal of

See Also: Interior Spaces and Features, Alteration
013

Porches

See Also: Galleries
Addition of decks and porches
094, 096

Alteration/Demolition
006, 018, 033, 039, 044, 054, 072, 073, 078, 085, 107

Enclosures
001, 033

Previous Owner, Project Work Undertaken by Previous Owner

001, 102

Rear Elevations

See: Secondary and Rear Elevations

Regulations, Project Work Undertaken Prior to Issuance of

018, 028

Replacement Materials

See: Artificial Siding
Brownstone
Doors
Limestone
Roofing
Sandstone, Replacement of
Windows
Wood

Reversibility

079

Roof Alterations

See Also: Additions, Rooftop
031, 038, 051, 078, 079

Sandblasting

See: Abrasive Cleaning

Sandstone, Replacement

040, 056

Secondary and Rear Elevations, Changes to

033, 049, 050, 072, 085, 091, 094

Selective Restoration

078, 096, 099

Setting

002, 068, 095, 097, 098, 103

Siding

See: Artificial Siding

Wood, Replacing clapboarding with shingles

Site

See: Setting

Skywalks

See: Pedestrian Bridges

Stairs and Stairtowers, Exterior

037, 083, 097, 105

Standards for Evaluating Significance Within Registered Historic Districts

064, 070

Standards for Rehabilitation, Secretary of the Interior's

Standard 1 (Compatible New Use)

020, 028, 033, 047, 053, 065, 066, 077

Standard 2 (Retention of Distinguishing Architectural Character)

001, 002, 003, 006, 011, 012, 013, 014, 015, 017, 019, 020, 021, 022, 023, 025, 026, 028, 029, 030, 032, 033, 036, 039, 041, 043, 044, 045, 047, 048, 049, 050, 051, 052, 053, 054, 055, 056, 057, 058, 059, 060, 061, 062, 065, 066, 069, 071, 073, 074, 075, 076, 077, 079, 080, 081, 082, 083, 084, 089, 090, 092, 094, 095, 097, 098, 099, 100, 101, 102, 103, 104, 105, 106, 107, 108

Standard 3 (Recognition of Historic Period)

004, 005, 006, 008, 010, 024, 029, 046, 054, 055, 056, 061, 085, 096, 107

Standard 4 (Retention of Significant Later Alterations/Additions)

012, 016, 018, 025, 027, 031, 041, 043, 053, 054, 061, 062, 073, 078, 096, 105

Standard 5 (Sensitive Treatment of Distinctive Features and Craftsmanship)

011, 014, 017, 020, 025, 029, 032, 033, 047, 048, 053, 054, 058, 059, 062, 065, 073, 080, 082, 084, 089, 090, 093, 100, 101, 104

Standard 6 (Repair/Replacement of Deteriorated or Missing Architectural Features Based on Historic Evidence)

013, 015, 029, 031, 032, 035, 038, 040, 042, 046, 049, 052, 054, 055, 056, 057, 059, 061, 065, 067, 069, 072, 073, 078, 082, 084, 086, 087, 088, 089, 090, 096, 099, 102, 105, 107

Standard 7 (Cleaning with Gentlest Method Possible)

009, 039, 063

Standard 8 (Protection/Preservation of Archeological Resources)

Standard 9 (Compatible Contemporary Design for New Alterations/Additions)

001, 003, 007, 010, 014, 022, 028, 030, 031, 034, 037, 045, 046, 048, 049, 050, 051, 058, 060, 065, 066, 067, 071, 072, 074, 075, 079, 080, 083, 085, 091, 092, 095, 097, 103, 106

Standard 10 (Reversibility of New Alterations/Additions)
026, 037, 047, 048, 051, 066, 079, 080

Storefronts

003, 004, 027, 030, 049, 050, 053, 061, 062, 067, 070, 073

Streetscape

075, 097, 098

Stucco

040

Surface Material, Nonhistoric

005, 070

Timing

See: Project Work Undertaken Prior to Issuance of Regulations

Vinyl Siding

See: Artificial Siding

Windows

See Also: Storefronts

Alteration/Demolition

015, 031, 032, 046, 048, 075, 107

New openings

050, 077, 094

Replacement

021, 029, 035, 046, 052, 057, 086, 087, 088, 089, 090

Wood

Abrasive cleaning

039

Removing interior woodwork

017

Removing paint from previously painted wood

036, 039

Replacing clapboarding with shingles

042



12

[Faint, illegible text]

