

National Park Service  
U.S. Department of the Interior


Submerged Resources Center



# Beached Shipwreck Archeology: Case Studies from Channel Islands National Park



Matthew A. Russell



Digitized by the Internet Archive  
in 2012 with funding from  
LYRASIS Members and Sloan Foundation

<http://archive.org/details/beachedshipwrech00russ>

**BEACHED SHIPWRECK ARCHEOLOGY:  
CASE STUDIES FROM  
CHANNEL ISLANDS NATIONAL PARK**

a product of the  
NATIONAL PARK SERVICE  
SYSTEMWIDE ARCHEOLOGICAL INVENTORY PROGRAM





**BEACHED SHIPWRECK ARCHEOLOGY:  
CASE STUDIES FROM  
CHANNEL ISLANDS NATIONAL PARK**

Matthew A. Russell

Submerged Resources Center  
Professional Reports  
Number 18

Submerged Resources Center  
Intermountain Region  
National Park Service

Santa Fe, New Mexico  
2005

Submerged Resources Center  
Intermountain Region  
National Park Service  
US Department of the Interior

# TABLE OF CONTENTS

LIST OF FIGURES .....	vii
FOREWORD .....	xi
ACKNOWLEDGEMENTS .....	xiii
EXECUTIVE SUMMARY .....	xv
1 INTRODUCTION .....	1
2 THE PACIFIC COAST LUMBER TRADE AND DEVELOPMENT OF THE LUMBER SCHOONER .....	9
Pacific Coast Lumber Trade .....	9
Pacific Coast Lumber Schooners .....	11
Decline of the Pacific Coast Lumber Schooner .....	17
3 THE HALL BROTHERS SHIPYARD AND THE SCHOONERS <i>Dora Bluhm, Comet and J. M. Colman</i> .....	19
Hall Brothers Shipyard .....	19
Vessel Histories .....	23
Schooner <i>Dora Bluhm</i> .....	23
Schooner <i>Comet</i> .....	27
Schooner <i>J. M. Colman</i> .....	31
Wreck Events .....	33
Schooner <i>J. M. Colman</i> .....	33
Schooner <i>Dora Bluhm</i> .....	37
Schooner <i>Comet</i> .....	38
Discussion .....	40
4 ARCHEOLOGICAL ANALYSIS .....	47
Location .....	47
Methodology .....	51
Description of Fieldwork .....	52
Northwest Cove Site .....	55
Intertidal Zone Iron Features .....	56
Wooden Elements and Fragments .....	72

	Cluster Point Site .....	82
	<i>Comet</i> Site .....	97
	Anchor Analysis .....	98
	Site Description .....	100
	Site Analysis .....	105
	Bow Structure .....	105
	Bow Rigging .....	121
	Ground Tackle .....	125
	Site Formation Processes .....	134
5	CONCLUSIONS .....	143
	REFERENCES .....	147
	APPENDIX A Enrollment and Registration Data: Schooner <i>Dora Bluhm</i> .....	153
	APPENDIX B Enrollment and Registration Data: Schooner <i>Comet</i> .....	161
	APPENDIX C Enrollment and Registration Data: Schooner <i>J. M. Colman</i> .....	165



## LIST OF FIGURES

1.1.	Channel Islands National Park .....	2
1.2.	<i>Comet</i> site exposed in Simonton Cove in 1984 .....	3
1.3.	<i>Comet</i> timbers and anchor exposed in 1984 .....	4
1.4.	<i>Comet</i> 's capstan in 1984 .....	4
1.5.	<i>Comet</i> site in April 1999 .....	5
1.6.	Shipwreck site formation processes based on Muckelroy .....	7
2.1.	Schooner <i>Watson A. West</i> at an unknown port .....	12
2.2.	Hulda and Otto Lembke aboard <i>Comet</i> at Santa Barbara, California, 1905 .....	17
3.1.	Map of Blakely Harbor, Washington, 1894 .....	22
3.2.	Hall Brothers Shipyard, Port Blakely, Washington, 1899 .....	22
3.3.	Schooner <i>Comet</i> docked at San Pedro, California .....	28
3.4.	<i>Comet</i> at Santa Barbara, California, 1904 .....	29
3.5.	Schooner <i>J. M. Colman</i> about 1900 .....	32
3.6.	<i>J. M. Colman</i> at anchor, San Pedro, California .....	32
3.7.	Driftwood camp at Point Bennett, San Miguel Island, ca. 1911 .....	36
3.8.	Additional view of driftwood, Northwest Cove, Point Bennett, San Miguel Island .....	36
3.9.	<i>Comet</i> aground in Simonton Cove, San Miguel Island .....	41
3.10.	<i>Comet</i> aground in Simonton Cove, San Miguel Island .....	41
3.11.	<i>Comet</i> 's stern, aground in Simonton Cove, San Miguel Island .....	42
3.12.	Unidentified woman on <i>Comet</i> 's forecandle deck .....	42
3.13.	Unidentified man on <i>Comet</i> 's forecandle deck .....	43
3.14.	Anchor stock sticking out of the sand in Simonton Cove in the 1980s .....	43
4.1.	<i>Comet</i> site and Northwest Cove site locations on San Miguel Island .....	48
4.2.	Aerial view of Northwest Cove on San Miguel Island's Point Bennett .....	48
4.3.	Aerial view of <i>Comet</i> site in Simonton Cove .....	49
4.4.	Cluster Point site location on Santa Rosa Island .....	50
4.5.	Aerial view of Cluster Point, Santa Rosa Island .....	50
4.6.	Volunteers working to expose <i>Comet</i> wreckage in October 1993 .....	54
4.7.	Archeologists mapping <i>Comet</i> 's bow section .....	56
4.8.	Features PB-016 and PB-034 are two identical hawse pipes .....	57
4.9.	Hawse pipe .....	57
4.10.	Donkey boiler .....	58
4.11.	Donkey boiler .....	59
4.12.	End view of the donkey boiler .....	59
4.13.	Crosshead mechanism from a pump-brake windlass .....	60
4.14.	Crosshead mechanism from a pump-brake windlass .....	61
4.15.	Part of the drive mechanism from a donkey engine .....	61
4.16.	The two upright circular features are connected by a buried drive shaft .....	62
4.17.	Windlass from <i>Falls of Clyde</i> in Honolulu, Hawaii .....	63

4.18.	The widely-spaced teeth indicate it is part of a messenger chain system .....	63
4.19.	Iron ring from a windlass messenger chain system .....	64
4.20.	Purchase rim from a pump-brake windlass .....	64
4.21.	Purchase rim .....	65
4.22.	Unidentified windlass element .....	65
4.23.	Feature PB-018 is a purchase rim .....	66
4.24.	Unidentified windlass element with the warping hub .....	66
4.25.	Feature PB-027 .....	67
4.26.	Another unidentified windlass element .....	67
4.27.	Feature PB-029 .....	68
4.28.	Unidentified windlass element with widely-spaced teeth .....	68
4.29.	Feature PB-026 with the messenger chain gear at top .....	69
4.30.	Windlass from <i>Falls of Clyde</i> in Honolulu, Hawaii .....	69
4.31.	Machinery mount for the donkey engine .....	70
4.32.	Feature PB-025 .....	70
4.33.	Unidentified object .....	71
4.34.	Unidentified object .....	71
4.35.	Unidentified object .....	72
4.36.	Keelson element with iron fasteners .....	73
4.37.	Feature PB-001 .....	74
4.38.	Fragment is possibly part of a deck clamp or shelf .....	76
4.39.	Feature PB-002 .....	76
4.40.	Iron fastener driven through an oak plug on feature PB-002 .....	77
4.41.	Plan view of feature PB-011, possibly part of a hatch coaming .....	78
4.42.	Oblique view of feature PB-011 .....	79
4.43.	Plan view of feature PB-014, likely part of the same coaming as feature PB-011 .....	79
4.44.	Feature PB-014 .....	80
4.45.	Hatch coaming depicted in Curtis 1919 .....	80
4.46.	Unidentified object .....	82
4.47.	Iron mast-band used as a fire ring at Cluster Point .....	83
4.48.	Hawse pipe located near Cluster Point .....	84
4.49.	Portion of a rudder stock with the iron yoke .....	84
4.50.	End view of the yoke attached to the end of a rudder stock .....	85
4.51.	Top of rudder stock depicted with yoke that attached it to a steering gear .....	85
4.52.	Feature CP-009, likely not part of <i>Dora Bluhm</i> .....	86
4.53.	Keelson element with iron fasteners .....	88
4.54.	Keelson element with iron fasteners .....	89
4.55.	Keelson element with iron fasteners .....	90
4.56.	Deck planking elements with iron fasteners .....	92
4.57.	Unidentified element with large iron fasteners .....	93
4.58.	Fragment of the centerboard trunk .....	94
4.59.	Feature CP-019 .....	94
4.60.	Feature CP-019 .....	95
4.61.	Feature CP-020 .....	96

4.62.	Feature CP-020 .....	97
4.63.	<i>Comet</i> 's anchor after exposure in 1993 .....	99
4.64.	<i>Comet</i> 's anchor ring .....	99
4.65.	<i>Comet</i> 's anchor .....	100
4.66.	<i>Comet</i> 's bow section looking down at forecastle deck .....	101
4.67.	<i>Comet</i> site in April 1999, looking at the port side outer hull timbers .....	101
4.68.	<i>Comet</i> site in 1999 .....	102
4.69.	<i>Comet</i> site in April 1999 .....	102
4.70.	<i>Comet</i> site plan .....	103
4.71.	Bow framing, including stempost, knighthead, hawse timbers and cant frames .....	106
4.72.	Bow framing, including stempost, knighthead, hawse timbers and cant frames .....	107
4.73.	Bow framing, showing difference between cant frames and half frames .....	107
4.74.	<i>Comet</i> port elevation drawing .....	109
4.75.	<i>Comet</i> 's bow .....	111
4.76.	Port knighthead is the large timber on the right side of photograph .....	113
4.77.	Top view of <i>Comet</i> 's knighthead, bowsprit and jibboom heel chock .....	113
4.78.	Bow section of a wooden-hulled schooner .....	114
4.79.	Planking details, showing deck and waterway hooks .....	115
4.80.	<i>Comet</i> site in April 1999 .....	116
4.81.	Top view of the aft end of the forecastle deck .....	117
4.82.	Perspective as if the viewer were standing on the main deck looking forward .....	117
4.83.	Schooner bow section showing bowsprit stepped into forward face of pawl post .....	118
4.84.	Schematic of schooner bow-section .....	118
4.85.	Bow pointers in a wooden-hulled schooner .....	119
4.86.	Schematic showing location of bow pointers in wooden-hulled schooner .....	120
4.87.	Vessel bow section showing location of gammon iron and jibboom heel chock .....	122
4.88.	Bull's eye above and forward of hawse pipe .....	123
4.89.	Bow rigging elements found on <i>Comet</i> site .....	123
4.90.	Rigging element off <i>Comet</i> 's port bow .....	124
4.91.	Rigging element from port cathead that secured jibboom guys .....	124
4.92.	Rigging element supporting jibboom guys on forward side of <i>C. A. Thayer</i> 's cathead ..	125
4.93.	Pump-brake windlass .....	126
4.94.	<i>Comet</i> 's windlass mounted on main deck .....	128
4.95.	<i>Comet</i> 's windlass, elevation view looking forward on main deck .....	128
4.96.	Pivoting rocker mechanism connected to windlass purchase arm or chain .....	129
4.97.	<i>Comet</i> 's port windlass purchase arm and windlass hardware on main deck .....	129
4.98.	<i>Comet</i> 's port windlass hardware laying on main deck .....	130
4.99.	<i>Comet</i> 's windlass and the iron shaft sticking out of the sand .....	130
4.100.	Windlass nearly identical to <i>Comet</i> 's windlass .....	131
4.101.	Messenger chain-driven windlass system .....	132
4.102.	<i>Comet</i> 's port-side hawse pipe .....	133
4.103.	<i>Comet</i> 's capstan .....	134
4.104.	<i>Comet</i> 's capstan .....	135
4.105.	Area of <i>Comet</i> 's preserved hull .....	138



# FOREWORD

---

When Don Morris, then park archeologist at Channel Islands National Park (CHIS), first suggested the investigation of three beached shipwrecks in the park as a master's thesis topic to Matt Russell in 1991, then a maritime archeology graduate student at East Carolina University (ECU), it was largely because of historical coincidence. Three Pacific Coast lumber schooners, *J. M. Colman*, *Dora Bluhm* and *Comet*, built by the Hall Brothers Shipyard of Puget Sound within a 5-year period between 1883 and 1888, all wrecked in the Channel Islands within a 6-year period between 1905 and 1911. That interesting historical connection sparked research into a related archeological and management question: are three separate sets of beached shipwreck remains on Santa Rosa and San Miguel Islands, which have been anecdotally attributed to *J. M. Colman*, *Dora Bluhm* and *Comet*, actually those of the three Hall-built schooners?

Shortly after joining the Submerged Resources Center (SRC) in 1993, at the park's request and with Don's and other CHIS staff support combined with SRC equipment and funding from the Systemwide Archeological Inventory Program (SAIP), Matt assembled a team and directed a comprehensive documentation of these three beached shipwreck sites. The project included an innovative methodology to address beached shipwreck remains to answer the question posed above.

Study of beached ship remains prior to Matt's work initially focused on complete hulls, for example, the 1769 Dutch East Indiaman *Amsterdam*, whose excavation began in Great Britain in 1969. In this country and in the

National Park Service, systematic study of beached ship remains began in 1981 and 1982 at Point Reyes National Seashore when Jim Delgado documented structural elements of Point Reyes shipwrecks exposed by winter storm erosion. Archeologists began systematically studying beached remains in this county in the mid-1980s: *King Philip*, *Reporter* and *Neptune* in Golden Gate National Recreation Area, vessels at Cape Hatteras, and a Civil War antitorpedo raft in Texas. The beached ship remains study reported here is one of the first attempts at a rigorous, systematic analysis of specific sites to determine their association with historically documented shipwrecks, while concurrently investigating the natural and cultural formation processes at work on the sites. The methodology presented in this report reflects a thorough, scientific documentation in a wide historical context, and a minimum impact approach within a management framework to meet park requirements.

This study is the second "special report" in the Submerged Resources Center Professional Report series. Special reports are not necessarily tied to any particular park or area (although in this case it is), but are meant to explore larger archeological issues and problems. The work presented here investigates beached shipwreck sites, their archeological value and the site formation processes that led to their creation and current state. This report, originally published as Matt's M.A. thesis from ECU in 1996, is revised and augmented with results from a 1999 project to record *Comet's* environmentally exposed remains in Simonton Cove, San Miguel Island. That 1999 project

led to a site report (*Comet Submerged Cultural Resources Site Report*) published in 2004, which incorporated portions of the original thesis, and portions of the *Comet* site report have been included in the present volume.

*Beached Shipwreck Archeology: Case Studies from Channel Islands National Park* is presented as a model for archeologists and resource managers of how this specific site type, beached shipwreck scatters, can be approached to maximize research potential to gain knowledge about the vessels represented. The value of beached shipwreck scatters as cultural resources demanding equal consideration to submerged shipwreck sites is here, I believe, well demonstrated. This study should help change the common perception that beached shipwreck scatters have little archeological value, and resource managers are encouraged to develop documentation programs for scattered beached remains and environmentally exposed shipwrecks.

The importance of the Pacific Coast lumber trade, its role in the economic development of

the region, and the principal vessel involved in that trade, the Pacific Coast lumber schooner, is convincing in Matt's report and provides the context for interpretation. The importance of the Northwest Cove, Cluster Point and *Comet* sites goes well beyond their association with that trade however. These sites represent nonrenewable archeological resources that offer material evidence of the lumber trade, insights into natural site formation processes, isolated element dynamics, and details of late-nineteenth century construction practices available nowhere else. This report is a fine illustration of the returns that can be derived from systematic study of often-dismissed beached shipwreck sites, and it provides a cogent case in point of why these sites deserve our efforts to study, protect and preserve them.

Larry E. Murphy, Chief  
Submerged Resources Center

# ACKNOWLEDGEMENTS

---

Many people contributed to the success of this project and report; it would not have been completed without their support. Thanks are especially due to Don Morris, Channel Islands National Park (CHIS) archeologist from 1985 to 2001, who supported the project and the fieldwork; Dr. Brad Rodgers directed my thesis at East Carolina University (ECU); other ECU committee members included: Dr. Michael Palmer, Dr. John Tilley and Larry Murphy, who served as outside reader for the original thesis. Those assisting me in the 1993 and 1999 field investigations were Jim Bradford, Jack Carraher, Dr. Georgia Fox, Bill Harris, Tom Harris, Mark Linder, Don Morris, Adriane Neidinger, Bob Schwemmer, Hank Silka, Patrick Smith, Jim Thompson and Ian Williams. Tim Smith and Mark Eckenrode assisted with data processing. J. Barto Arnold III, Dr. Dave Conlin, Dr. Annalies Corbin, Dan Lenihan, Don Morris, and Larry Murphy reviewed this report and provided valuable comments, and Brett Seymour assisted with illustrations. Fran Day designed the report and prepared it for publication. Thanks also go to Rob Turner for his final rendering of the *Comet* site map and Nancy Lamm for her *Comet* illustrations. Many CHIS staff provided valuable advice and support over the years, especially Ann Huston, David Kushner, Mark Linder, Don Morris, Diane Richardson, Tim Setnica, C. Mack

Shaver, Dave Stoltz, Dwight Willey and Ian Williams. In addition, Jim Delgado, John Foster, Jack and Monica Hunter, Jim Lima, Mark Norder, Bob Schwemmer, Sheli Smith, and Patrick Smith and the rest of the Coastal Maritime Archaeology Resources crew have contributed to research at CHIS in innumerable ways. Collection managers, archivists and other staff at the following institutions were extremely helpful during historical research for this project: Cabrillo Marine Museum, East Carolina University Library, Los Angeles Maritime Museum, the National Archives in Washington D.C., Santa Barbara Museum of Natural History, San Francisco Maritime National Historical Park and University of California-Santa Barbara Library. Richard Lawrence, Mark Wilde-Ramsing and Leslie Bright from the North Carolina Underwater Archaeology Unit discussed their beached shipwreck tagging program with me and provided information on the Hall-built schooner *Bainbridge*. Finally, I would like to especially acknowledge the pioneering research conducted on beached shipwreck remains by our colleague and friend, the late Brina Agranat.

Matthew A. Russell, Archeologist  
Submerged Resources Center





# EXECUTIVE SUMMARY

---

Between 1993 and 1999, the National Park Service's Submerged Resources Center worked with Channel Islands National Park to investigate three historical shipwreck sites on San Miguel and Santa Rosa Islands likely to be the Pacific Coast lumber schooners *J. M. Colman*, *Dora Bluhm* and *Comet*. This publication presents results of those investigations and demonstrates the feasibility and historical and scientific value of rigorous study of scattered, beached shipwreck sites, which have often been dismissed as uninformative.

Study of scant remains at the Northwest Cove and Cluster Point sites clearly confirms how much can be learned from scattered, beached shipwreck remains. This project has shown that precise, systematic testing and examination of even widely scattered, disarticulated hull elements and fragments can produce viable interpretations that contribute directly to our knowledge about specific vessels and vessel types. The methodology reported here of comparative analysis of element and fragment shape and characteristics; scantling size; fastener type, size and number; and wood species to original construction contracts,

published classification rules and extant vessels makes it possible for researchers to distinguish between structural and nonstructural members, and identify hull elements and fragments. This methodological approach led to confirmation that several features from Northwest Cove and Cluster Point are most likely structural members from wooden, ocean-going vessels with construction consistent with late-nineteenth century practices, making association with *J. M. Colman* and *Dora Bluhm* a high probability.

The schooner *Comet's* bow, although representing only about 10% of the hull, is one of the most well preserved historical shipwreck sites in Channel Islands National Park and one of the best-preserved wooden shipwrecks recorded on the West Coast. *Comet's* bow is historically significant because it represents a regionally important vessel type linked to the economic development of major metropolitan areas on the Pacific Coast, and it offers insight into West Coast shipbuilding practices, especially those particular to lumber schooners. *Comet* and the possible *J. M. Colman* and *Dora Bluhm* site documentation reported in this publication expand our knowledge about a vessel type integral to Pacific Coast maritime history.



# CHAPTER 1

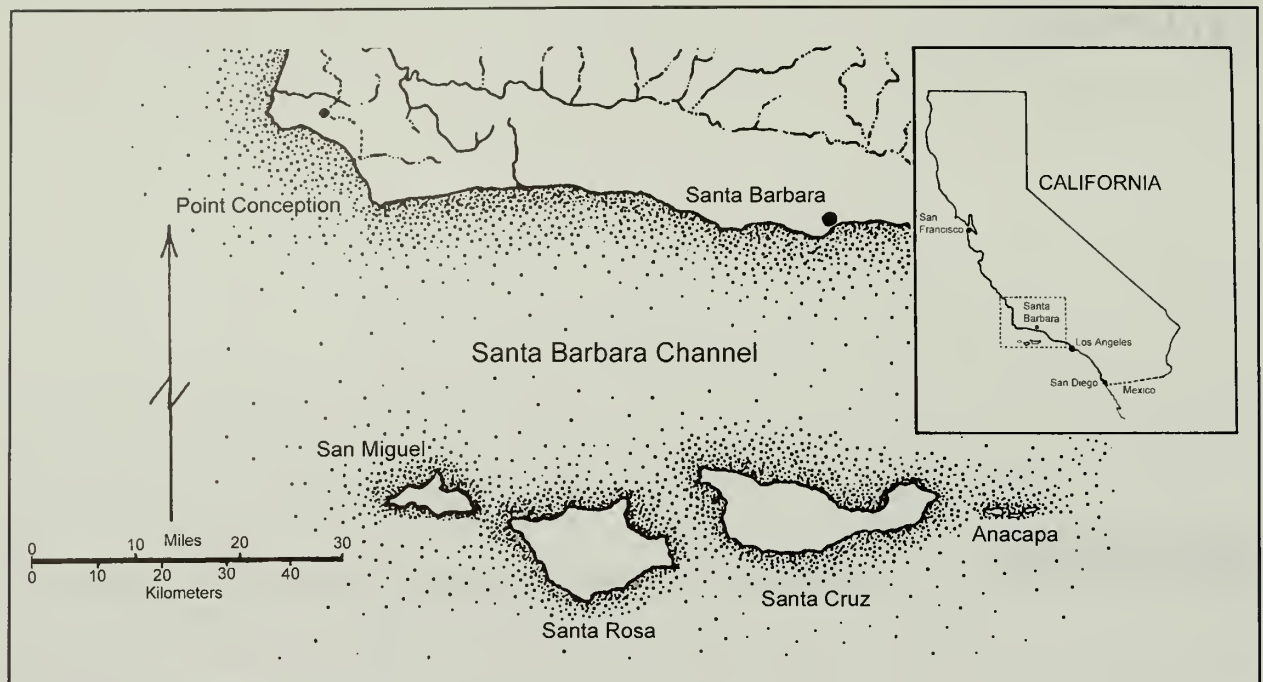
## Introduction

---

This study reports on investigations of the material remains of three shipwreck scatters on beaches in Channel Island National Park (Figure 1.1). Documentation and analyses of these vessels, three Pacific Coast lumber schooners built by the Hall Brothers Shipyard of Puget Sound, are used as a case study for examining a larger issue: the value of beached shipwreck scatters as archeological resources. For the most part, these sites consist of widely scattered material located either in the intertidal zone or above the high-tide line. From the project's beginning it was clear that, unless environmental conditions favored deep burial of remains in sand, these sites would likely produce little in the way of articulated wreckage and would consist largely of scattered, disarticulated remains. This site type has received little attention before; scattered beach remains are often dismissed as unintelligible or unimportant. This study demonstrates that using a systematic analytical approach, beached shipwreck scatters can be reliably interpreted, and they contain

valid archeological data. The site formation processes that continue to affect these sites are also examined in detail. In addition to its general relevance to many coastal areas, this study also contributes locally and regionally by examining the historical and material record of an important vessel type, the Pacific Coast lumber schooner.

In a broad context, this study demonstrates the value of widely scattered, beached shipwreck remains. Often, scattered sites like these are labeled as insignificant and go unrecorded. In his contribution to Gould's *Shipwreck Anthropology* (1983), National Park Service archeologist Larry Murphy notes, "to dismiss scattered sites because of preconceived notions about the information they may contain is a serious and unnecessary mistake that will compromise the amount of information ultimately obtainable from the shipwreck data base (Murphy 1983:77)." Whether this statement is applied to sites containing scattered artifacts with little remaining hull structure, like many Florida shipwrecks, or to widely scattered



**Figure 1.1.** Channel Islands National Park.

hull components of beached shipwrecks, it holds equally true. This study presents a methodology for systematically analyzing this particular type of wreck site. Systematic examination can yield valuable archeological data on period construction techniques and site formation processes. This methodology allows one to 1) determine which pieces in a scatter are structural shipwreck elements and which are nonstructural or not associated with a shipwreck; 2) offer a likely identification of each structural element; and 3) when coupled with appropriate historical documents (insurance classification rules, construction contracts, etc.) determine estimated vessel age, tonnage and whether the pieces are likely from a particular historically documented shipwreck. In addition, initial recording of wreck scatters serves as a baseline for future documentation, which can reveal movement patterns and add significantly to our knowledge of beached site dynamics. This knowledge

becomes “a data base for understanding distribution processes, which is basic to developing predictive models for the ‘break up’ of wooden shipwrecks (Delgado 1986:107).” Scattered, beached shipwreck sites cannot be dismissed as archaeological resources because of untested assumptions about the lack of data they contain.

This study focuses on three sites likely representing the Pacific Coast lumber schooners *Dora Bluhm*, *Comet* and *J. M. Colman*. These vessels were constructed by the Hall Brothers Shipyard of Puget Sound during the 1880s and wrecked in the Channel Islands between 1905 and 1911. Historical documentation supports likely wreck locations for each vessel, and shipwreck material exists today at each location. One goal of this study was to determine whether wreck scatters found at Northwest Cove on San Miguel Island and Cluster Point on Santa Rosa Island, locations consistent with the documented

wreck sites of *J. M. Colman* and *Dora Bluhm*, actually represent the remains of the Hall-built schooners. To answer this question, both sites were systematically recorded and analyzed, and compared to historical documents to determine possible associations with the wrecked vessels. Material remains at both of these sites are very limited compared to *Comet's* remains.

National Park Service (NPS) personnel have known about the *Comet* site, located in Simonton Cove, San Miguel Island, since at least 1977 when the first documented site exposure occurred. The next recorded exposure was in 1984, when an NPS ranger took several photographs of *Comet's* exposed remains (Figures 1.2, 1.3 and 1.4). Although an anchor and capstan are clearly visible in the photographs, insufficient hull structure was exposed then to allow identification of specific features. Between 1984 and 1999, the site

remained deeply buried by beach sand with only the tip of the anchor stock visible. In 1993, the author, from the NPS Submerged Resources Center (SRC, formerly Submerged Cultural Resources Unit) unsuccessfully attempted to uncover *Comet's* remains during an investigation of other coastal lumber schooners wrecked in the park. Due to extremely deep sand covering the site, he and his team were only able to expose and document the anchor (Russell 1996). At that time, it was apparent that complete site documentation would only be practical when the site uncovered naturally, as it had in 1977 and 1984. This finally happened in 1999.

Although investigators presumed the exposed remains were from *Comet's* bow (based on the anchor and capstan in the 1984 photographs), they were unprepared for just how intact and well preserved the site is. The hull remains observed include *Comet's* nearly



**Figure 1.2.** *Comet* site exposed in Simonton Cove in 1984. NPS photo by Reed McClusky.



**Figure 1.3.** *Comet's* timbers and anchor exposed in 1984. NPS photo by Reed McClusky.



**Figure 1.4.** *Comet's* capstan in 1984. NPS photo by Reed McClusky.



**Figure 1.5.** *Comet* site in April 1999, looking straight towards the bow, which is canted to the left in this photo. The forecastle deck is to the left, port side outer hull planking to the right and the bowsprit is in the bottom of the photo. NPS photo by Matt Russell.

intact bow from the break of the forecastle deck forward (Figure 1.5). The bow section is heeled to starboard; consequently, much of the port side has been exposed and is now deteriorated. But the starboard side, including the starboard half of the forecastle and main decks, is largely intact with machinery still mounted in its original location. Although only the bow section was observed during this project, this section of *Comet's* hull is the most intact and well-preserved Pacific Coast lumber schooner documented in the archeological record. Only one other intact section of lumber schooner hull has been recorded on the West Coast, which was a small section of the side of

the schooner *Neptune* (Delgado 1986:95–108). Other than *C. A. Thayer* and *Wawona* preserved as museum ships at San Francisco Maritime National Historical Park and NW Seaport Maritime Heritage Center and the only two lumber schooners still afloat, *Comet* provides the best opportunity yet discovered to learn about the design, construction and modifications of these once common West Coast vessels. Given the high-energy nature of San Miguel Island's beach environment, *Comet's* preservation counters the common sense notion of poor preservation of beached shipwreck remains. Under certain initial conditions, a beached shipwreck can be quickly buried and remain very well preserved (Delgado 1985). *Comet* is a good example of a well-preserved beached shipwreck site.

Both natural and cultural formation processes have been integral in shaping the archeological record found at these sites. Schiffer (1987:5) has argued that “untangling the many events and processes that contribute to the observed variability in the contemporary properties of the archaeological record” is vital to sound archeological inference and understanding the material record. Although revealing patterned human behavior was not a primary research objective in investigating these sites, understanding site formation processes is fundamental to a full understanding of the sites as archeological resources.

Muckelroy (1978) has suggested several transformational factors and processes unique to shipwrecks in the archeological record. His extracting filters and scrambling devices have direct application to the sites recorded on San Miguel and Santa Rosa Islands. His flow diagram representing the evolution of a shipwreck (Muckelroy 1978:158) incorporates, with a few revisions, all of the factors that have affected the formation of the sites studied: the process of wrecking, salvage operations,

disintegration of perishables, sea-bed movement, and deposition of intrusive materials (Figure 1.6). A close examination of site formation processes at work on these three shipwrecks has contributed a more complete understanding of the archeological record.

In addition to acting as control for the archeological research, the historical background for this study places the vessels in the context of the late-nineteenth century Pacific Coast lumber trade. As Lenihan (1983:49) noted, shipwrecks do not occur in a cultural vacuum. They are part of a complex regional system of trade and commerce. Before discovery of gold at Sutter's Mill in late 1848, maritime activity on the United States' Pacific Coast was sparse. The California gold rush, however, sparked a mass migration westward that radically changed Pacific Coast history. The sudden influx of thousands of people created an instant market for every kind of goods imaginable. Foremost among these was lumber. Vast supplies of lumber were needed for construction of emerging gold rush cities, and later for the burgeoning metropolitan areas in southern California.

Before the gold rush, exploitation of Pacific Northwest timber stands progressed slowly. With the sudden demand for lumber in California, however, sawmills rapidly appeared throughout Puget Sound, Oregon and California. The most economical way to transport lumber to the San Francisco and southern California markets was by sea, which prompted emergence of a vessel-type uniquely suited to the conditions of this trade: the Pacific Coast lumber schooner. Pacific Coast environmental conditions dictated design and construction of hundreds of vessels engaged in the coastal lumber trade. The lumber schooner, from its emergence in the 1870s until after World War I, was the most important vessel type involved in the West Coast lumber trade. These

schooners played a vital role in California's development, supplying raw materials necessary to build virtually every city in the state, as well as supplying the American Southwest, Mexico, and South America.

Of the dozens of Pacific Coast shipyards that appeared in response to the demand for vessels of all kinds, a handful became recognized for the quality of their work. Their names became synonymous with West Coast shipbuilding. Among these was Hall Brothers Shipyard of Puget Sound. The three Hall brothers, Winslow, Isaac and Henry, learned their trade in Massachusetts, operating a yard there until they moved to the West Coast. From 1874 to 1903, the Hall Brothers built 108 vessels at their Puget Sound yards, first at Port Ludlow, later at Port Blakely. The majority of the vessels they built were coastal lumber schooners.

This study includes a history of the Pacific Coast lumber trade during the second half of the nineteenth century and the development of the Pacific Coast lumber schooner. Each vessel investigated, *Dora Bluhm*, *Comet* and *J. M. Colman*, is documented from launch to loss, and the events that led to the wreck of each is described. The unique circumstances of these shipwrecks—three vessels built at the same shipyard in a five-year period and later wrecked in the same group of islands within a six-year period—provide an interesting historical link. It is reminiscent of the fate of the sister ships *Frank H. Buck* and *Lyman Stewart*, oil tankers wrecked 15 years apart in the exact same spot in what is now Golden Gate National Recreation Area, in San Francisco (Delgado and Haller 1989:65).

In addition to *Comet*, *J. M. Colman* and *Dora Bluhm*, only one Pacific Coast lumber schooner, *Neptune*, built by Hans Bendixsen, has been documented archeologically (Delgado 1986:95–108). The only two surviving Pacific Coast lumber schooners, *C.A. Thayer* and



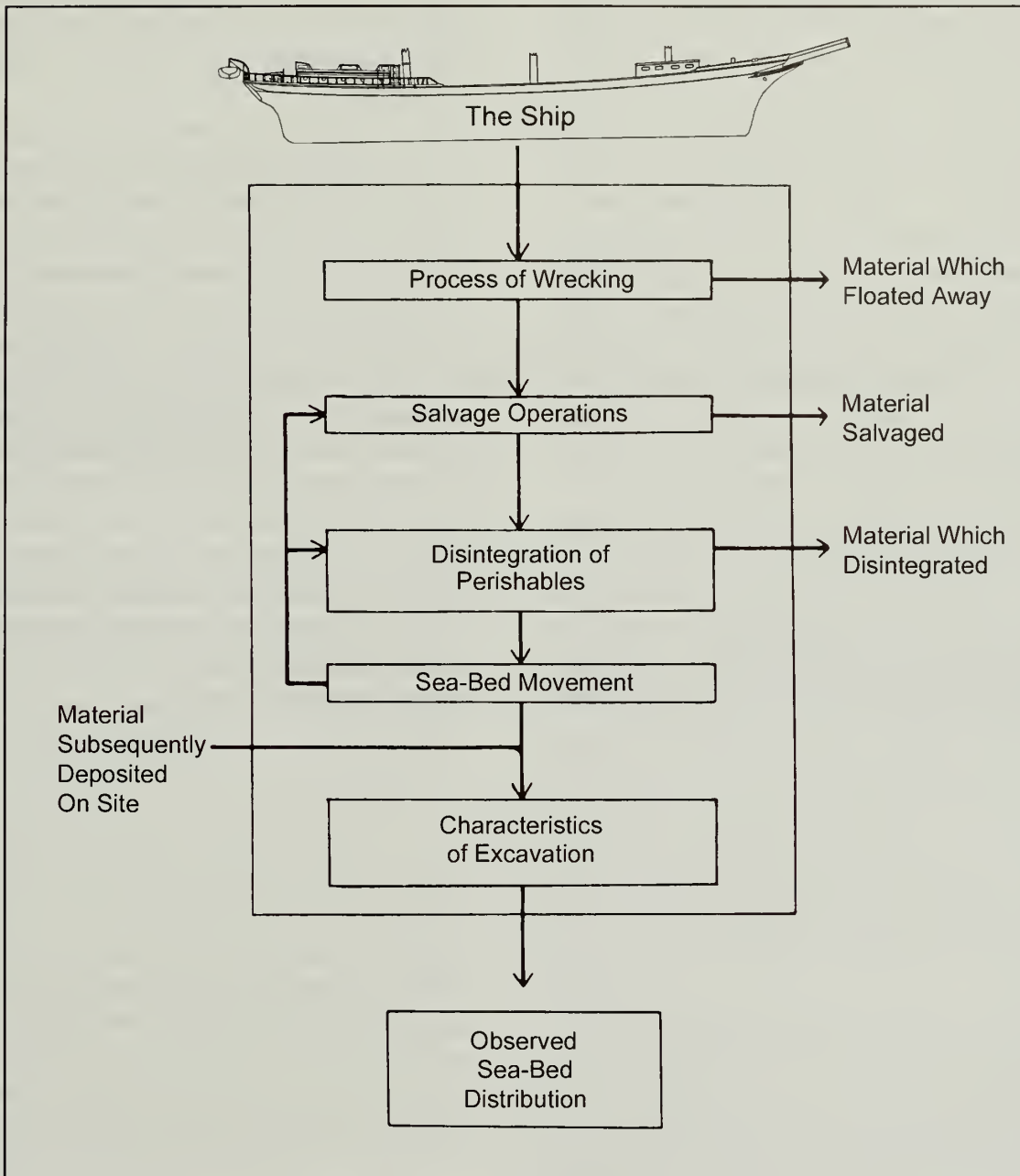


Figure 1.6. Shipwreck site formation processes based on Muckelroy (1978:158).

*Wawona*, were also Bendixsen-built vessels. Besides *Comet*, *J. M. Colman* and *Dora Bluhm*, only two other examples of Hall-built vessels have been identified in the archeological record: *Reporter*, a three-masted schooner wrecked on Ocean Beach, San Francisco, now part of Golden Gate National Recreation Area; and *Bainbridge*, wrecked on Cape Hatteras, North Carolina, just north of the National Seashore boundary. *Reporter*'s remains lie deeply buried by beach sand, and only scattered rigging elements were observed (Delgado 1985). *Bainbridge* was represented by only a small section of hull side, which was recorded in 1979 and has since been removed from the beach and destroyed by the property owner (Richard Lawrence, personal communication 1993). Little has been learned about the Hall Brothers from the archeological record. Pacific Coast lumber schooners are important enough, and their construction techniques, especially those employed by the Hall Brothers, so poorly documented, that even scant remains should

be examined with care. Rarity of lumber schooners in the archeological record and the potential remains of three in close proximity prompted this research project in order to augment knowledge of these once common vessels.

This project is a product of the National Park Service's Systemwide Archeological Inventory Program (SAIP), and it was supported by Channel Islands National Park and the National Park Service's Submerged Resources Center. The results of this study provides archeologists and resource managers with information necessary to make appropriate decisions regarding the long-term preservation of beached shipwreck scatters. More important, however, this study demonstrates the research value of beached shipwreck scatters as a whole, and therefore has relevance to many areas, both inside and outside the National Park System. This investigation is presented as an example of what can be learned from all-too-often dismissed beached shipwreck remains.

## CHAPTER 2

# The Pacific Coast Lumber Trade and Development of the Lumber Schooner

---

### PACIFIC COAST LUMBER TRADE

Most historians agree the Pacific Coast lumber trade began in the late 1840s. Lumber was certainly used and exported before this period, but in a quantity too small to be considered a sustained trade or industry. The gold rush sparked the American development of California, first in the gold rush cities of San Francisco, Sacramento and Stockton; later in southern California's metropolitan areas. These burgeoning urban areas prompted development of Washington, Oregon and northern California's lumber industries, all of which ultimately relied on the Pacific Coast lumber schooner.

In 1850, with the Pacific Northwest lumber industry still in its infancy, it was cheaper to ship wood 10,000 miles from the East Coast than to obtain it from the closer Pacific Northwest (Hall 1884:131). Increasing lumber demand fueled by the gold rush, however, insured a boom in the West Coast lumber industry by the 1860s.

The lumber business received another boost during the 1880s with a sharp increase in southern California development and the demand for lumber it created. Further economic upswings occurred in the early twentieth century, especially after the 1906 San Francisco earthquake (Olmsted 1972:4). Although railroads came to the West during the 1880s, demand for coastwise and export lumber remained high until after World War I (Vinnedge 1923:11).

In 1849, when the lumber industry was still young, the West Coast was a vast, untapped source of premium soft woods. Puget Sound, the only protected, natural ocean harbor between San Francisco and the Canadian border, became the main lumber source for the entire Pacific Basin. Washington Territory's magnificent timber stands became legendary. John Hittell, commenting on Pacific Coast industries in 1882, wrote the "fir and cedar forests of Washington . . . as sources of lumber for exportation . . . are unequalled" (Hittell 1882:35). The 1872

*Business Directory, and Guide to Washington Territory* estimated more than 20 million acres of marketable timber in Washington Territory, consisting mostly of Douglas fir, hemlock, cedar and spruce (Anonymous 1872:2).

Pacific Coast timber exploitation began in earnest with the huge demand for lumber created by the California gold rush. At the height of the gold rush, lumber, which could be obtained in the Pacific Northwest for \$10 per thousand board feet (bf), was selling for \$500 per thousand in San Francisco (McNairn and MacMullen 1945:12). [Note: The unit of measure used for lumber was, and still is, the bf. A bf is 144 in.<sup>3</sup> of lumber — a 12-in. square board, 1-in. thick, equals 1 bf.]

San Francisco remained the West Coast lumber industry's commercial center throughout the nineteenth century. Most Northwest mill operators had San Francisco partners who marketed the final product and obtained capital for the mill (DeLong 1985:39). Initially, most mill operators relied on independent shippers to transit lumber to market. This changed quickly, however, as mills greatly reduced overhead costs by purchasing their own lumber schooner fleets. For example, in 1862, the Puget Mill Company owned at least ten vessels; two decades later it owned a fleet of sixteen sailing vessels and four tugs (Cox 1974:116). The Port Blakely Mill Company acquired its first three vessels in 1866. Its fleet expanded rapidly, especially when the Hall Brothers, a well-known Puget Sound shipyard, moved to Port Blakely in 1880 and began adding to the supply of available sailing vessels (Cox 1974:121).

In the early 1880s, between 150 and 200 million bf of lumber were shipped from Puget Sound annually (Hittell 1882:215; Johansen and Gates 1957:389). The increasing lumber output was fueled by California demand, which increased rapidly during the 1880s. The Santa Fe Railroad's completion into Los Angeles in 1885 set off a major boom in southern California

real estate development. Many companies anticipating this boom set up lumberyards in the area before 1885. For instance, in addition to its northern California lumberyards at Vallejo and Alameda, the Port Blakely Mill Company acquired new yards at Santa Barbara, San Buenaventura and San Pedro during the mid-1880s (Cox 1974:122). Between 1883 and 1889, total lumber shipments to California increased from 200 million bf to 323 million bf annually (Johansen and Gates 1957:390).

The two main Los Angeles-area harbors at this time were Santa Monica and Wilmington (which later became San Pedro). These ports were not ideal, however. In 1882, John Hittell wrote in *The Commerce and Industries of the Pacific Coast of North America*: "Santa Monica has a wharf accessible for large vessels with abundant room and deep water; but the anchorage is not secure in stormy weather. All the steamers and nearly all the sailing vessels go to Wilmington . . ." (Hittell 1882:29). The problem with Wilmington was that it was too shallow for navigation at low tide. Therefore, all cargo had to be lightered ashore, which increased shipping costs into this port (Hittell 1882:29). Wilmington harbor improvements began in 1871, but a universally accessible port was not finished until the 1890s, at which time San Pedro became Los Angeles' chief port (Barsness 1965:293). The real estate boom ceased in the 1880s, and lumber demand from southern California decreased significantly until another building boom occurred at the beginning of the twentieth century. During the second decade of the twentieth century, California received an average of 1 billion bf of lumber annually from the Pacific Northwest. California remained a steady market for lumber until the decline of coastwise shipping after World War I (Cox 1974:219; Vinnedge 1923:16).

In addition to California, several other coastal markets opened for Pacific Northwest lumber in the 1880s. Chile's victory over Peru

and Bolivia in the War of the Pacific (1879–83) encouraged them to embark on a program of railroad construction that lasted throughout the decade creating demand for lumber (Cox 1974: 214–215). Limited development also occurred in Peru and Mexico during the 1880s and 1890s, which created further lumber markets requiring shipping for transportation.

On Puget Sound, the Northern Pacific Railroad's 1883 arrival into Tacoma created an economic tremor (Chasan 1981:15). This railroad was extended northward from the Columbia River, and Tacoma became its first seaport connection. The railroad's arrival allowed a vast increase in the amount of lumber cut in the Pacific Northwest: in 1890, Washington cut more than one billion bf of timber; in 1895, two billion bf; and three billion in 1902 (Johansen and Gates 1957:389). In the early twentieth century, many smaller mills around Puget Sound closed due to high technological costs; railroads and modern, mass production mill machinery required a tremendous capital outlay (Newell and Williamson 1960:142). Although railroad competition affected ocean-going trade, shipping lumber by sea still dominated the coastal and overseas markets into the twentieth century. Nonetheless, midway through the first decade of the century, total lumber shipped by rail surpassed its sea-borne competition, which signaled the inevitable decline of the Pacific Coast lumber schooners, both sail and steam (Newell and Williamson 1960:112).

Although the lumber industry is still a mainstay of Pacific Northwest economy, the historical period of lumbering that utilized sailing, and later steam, schooners as a means of transport ended after World War I. At this time, transportation needs not fulfilled by railroads were taken over by steel-hulled, steam-powered vessels. From the 1870s to the 1920s, however, coastal lumber transportation relied

solely on ships specially designed for the lumber trade. These vessels, the two-, three- and four-masted coastal lumber schooners, were designed to reflect the particular needs of the Pacific Coast lumber trade, and they came to dominate it during this period.

### **PACIFIC COAST LUMBER SCHOONERS**

West Coast geography ensured that transporting milled lumber to California markets was carried out solely in ocean-going vessels into the 1880s. The Sierra and Rocky Mountains were natural barriers to overland trade, and there were no means of overland transportation before the mid-1880s completion of the transcontinental railroads (Mears 1935:48).

A distinctive vessel-type emerged for lumber transportation: the Pacific Coast lumber schooner, whose design was influenced by Pacific Coast environmental conditions and the requirement to carry an all-lumber cargo (Figure 2.1). The lumber schooner carried the raw material of California development. It delivered the basic construction material, which laid the foundation for nearly all California's metropolitan centers, making the vessel regionally significant as the primary cargo carrier.

The focus of West Coast shipbuilding activities during the 1860s was on the small coastal trader, and a variety of different vessels were used in the lumber trade. Soon, however, shipyards were producing larger vessels that would bring higher profit margins with each voyage.

Schooners built for the Pacific Coast lumber trade during the early-1870s generally ranged in size from 100 to 300 tons, with the majority in the 100 to 200-ton range. At Humboldt Bay, the second most important shipbuilding region on the Pacific Coast behind Puget Sound, in a



**Figure 2.1.** Schooner *Watson A. West* at an unknown port. *Watson A. West* was also built by the Hall Brothers. Photo courtesy of San Francisco Maritime NHP.

three-year period, 1874–76, 31 schooners totaling 4,059 tons were built, an average of just over 130 tons per vessel (Hall 1884:132). The first three-masted schooner registering larger than 300 tons, *Sunshine*, was built on the Pacific Coast in 1875 (MacGregor 1982:61). Larger hulls soon became common: most lumber schooners built in the late-1870s and early-1880s approached 300 tons in size. Henry Hall noted in his 1884 *Report on the Shipbuilding Industry of the United States* that “latterly the vessels built at Humboldt have been schooners of 250 and 300 tons register. . .” (Hall 1884:132). An important “first” was achieved in 1882 when the Hall Brothers of Port Blakely constructed *William Renton*, the first three-masted schooner on the Pacific Coast registering more than 400 tons (MacGregor 1982:61).

Four-masted schooners built for the lumber trade did not make an appearance until the late

1880s, when they became an important addition to the industry. A total of 130 four-masted schooners were built on the Pacific Coast between 1864 and 1904, most registering between 550 and 750 tons. Five-masted schooners, huge vessels generally registering more than 1,000 tons, did not play a significant role in the coastal lumber trade, but were more heavily involved in overseas trade. The first “proper” Pacific Coast-built, five-masted schooner was *Inca*, built by the Hall Brothers in 1896, registering 1,014 tons. Only nine five-masters were constructed between 1888 and 1916 (MacGregor 1982:62, 109).

In addition to being convenient, Puget Sound’s abundant timber made shipbuilding material inexpensive (Hall 1884:131). A hypothetical cost comparison between building a three-masted ship in Bath, Maine, versus Puget Sound, conducted by Hopkins in his 1874

publication, *Shipbuilding on the Pacific Coast* (No. 2), showed an enormous difference. The price for materials in Bath, including masts and yards, would be \$39,305 compared to \$14,997 for the same materials in Puget Sound (Hopkins 1874:22). On the West Coast, milled lumber ready for shipbuilding could be purchased for \$10 to \$20 per thousand bf, while on the East Coast it cost between \$40 and \$65 (Hopkins 1874:21).

The region's chief timber was Douglas fir (*Pseudotsuga menziesii*), known as "yellow fir" in the nineteenth century. Douglas fir proved to be an ideal wood for shipbuilding, and the San Francisco Board of Marine Underwriters endorsed it in 1875 as an accepted shipbuilding material (DeLong 1985:14). Both Hall and Hopkins praised Douglas fir for shipbuilding. One of the greatest selling points was the length of timber that could be obtained. Hall noted that West Coast trees grew from 150 to 300 ft. tall, so that "keel and keelson pieces and plank could be obtained of any length, and a vessel could be built with a far less number of butts and joints than in any other part of the United States" (Hall 1884:131). To this Hopkins added:

It is needless to remark that the great length of our lumber saves labor and fastening in scarphs and butts, gives greater elasticity to the ship's hull, and diminishes the danger of springing a leak. Moreover, our firs are superior to oak in the tenacity with which they hold iron fastenings. Bolts and spikes will generally break before they can be drawn or backed out of fir, and iron never becomes "sick" when imbedded in it. . . [Hopkins 1874:21].

As noted by Hopkins, fir holds fasteners better than oak because, as a soft wood, it swells much more than oak when immersed in water.

In addition, it was thought that fir contained a balsam that reduced iron deterioration, an attribute lacking in oak (Hall 1884:131). Because of these qualities and the growing acceptance of Douglas fir as a shipbuilding material, the Pacific Coast became a major shipbuilding center.

In 1875, 14 shipyards were active on Puget Sound; by the end of the era of coastal sailing schooners, more than 50 major shipbuilders operated on the West Coast (Williamson and Gibbs 1976:58; Newell and Williamson 1960:21). There was a trade-off between building vessels at San Francisco (then still a major shipbuilding center) and building on Puget Sound. Shipyards at San Francisco had the disadvantage of increased lumber cost, while builders at Puget Sound had to obtain fasteners, sails, rigging, oakum and other materials not available in the Pacific Northwest from San Francisco (Hopkins 1874:18). Regardless, shipbuilding in the Pacific Northwest became a major industry that complemented the nearby lumber mills. Both large mill companies and independent shippers accumulated fleets, so the demand for vessels during this time remained steady (Newell and Williamson 1960:21).

The schooner-rigged vessel proved best suited for the Pacific Coast lumber trade in the second half of the nineteenth century. This ship type, with fore-and-aft rigging and two or more masts, developed as a distinct American design in the early-eighteenth century (Edson 1989:198). The first mention of the term "schooner" comes from American colonial records. During this period, schooners were fitted with at least one square topsail and were known as "topsail schooners" (Bauer 1988:32; Edson 1989:198). By the turn-of-the-nineteenth century, however, this topsail was largely abandoned in the United States, and a pure fore-and-aft rig became prominent (Edson 1989:205). By 1800, most vessels involved in the American

coastal trade were schooners because of the sailing advantages offered by this type of rig in prevailing and offshore winds (Chapelle 1935:258). The fore-and-aft-rigged vessel had three major advantages over the traditional ship rig: it could sail closer to the wind; it could more easily maneuver into harbors and rivers; and it required a smaller crew for an equivalent size ship (Hall 1884:93; Bauer 1988:191). The attributes that led to its adoption gave schooners nearly two centuries of popularity, lasting until the final days of sail (Edson 1989:203).

In the eighteenth century, East Coast schooners were small vessels, carrying two masts and ranging from 40 to 50 tons. During the mid-nineteenth century, however, they grew considerably: two-masters ranged from 100 to 250 tons, and three-masters ranged from 300 to 750 tons (Hall 1884:94). The shift to three-masted schooners on the East Coast began around 1850, and by the mid-1860s, they were the most common vessels in the coastal trade (Chapelle 1935:258–259). The increase in number of masts was an effort to reduce individual sail size so that smaller crews could handle them, while at the same time increasing the total canvas spread necessary for larger hulls and greater speed. During the 1870s, East Coast three-masted schooners increased in size, growing from an average 500 tons to an average 920 tons (Bauer 1988:271).

West Coast schooners, especially lumber schooners, had a different configuration than those on the East Coast. West Coast schooners often had full poop decks and raised forecastle decks. In addition, West Coast schooners often omitted separate topmasts, leaving tall, one-piece masts. Employing a “leg-o-mutton” (triangular) sail on the after-most mast was also a popular West Coast innovation (Greenhill 1980:76).

The sailing qualities of schooner-rigged vessels were appropriate to beat up the West

Coast against the prevailing northwesterly winds. Early lumber schooners were small, two-masted vessels with a cargo capacity between 75,000 and 150,000 bf of lumber. Larger, three-masted schooners became dominant during the 1870s (Ryder 1948:28–29; Olmsted 1972:2). Three-masters had a maximum capacity of approximately 500,000 to 600,000 bf (Martin 1983:166; Newell 1966:80). Finally, in the late 1880s, four-masted schooners, which could carry 650,000 to 1,200,000 bf, became common (Olmsted 1972:2; Newell 1966:68).

Lumber schooner construction was tailored to the trade’s specific requirements and reflected a design that was, above all, economically viable. The Pacific Coast lumber schooner needed to be loaded quickly; carry this heavy, cumbersome cargo to its destination; discharge it quickly; and return empty, without ballast (DeLong 1985:1; Olmsted 1972:4). On these short trips, it was not economically feasible to load ballast for each return voyage and discharge it before loading lumber for the next trip. Rapidly increasing demand and expanding markets put a high value on speed and quick turn-around times in port.

The West Coast lumber schooner design that eventually became standard was a single-decked vessel (giving it only one large hold) that had a broad beam, long bow, square or elliptical stern and oversized hatches to allow quick and efficient lumber stowage (Hall 1884:133). In addition, they were sometimes fitted with bow or stern ports that allowed easier access to the hold and quicker loading (Cox 1974:247).

West Coast vessels had shallow drafts and flat bottoms for two main reasons. First, shallow draft resulted in a reduced distance between the keel and the deck, which assured satisfactory structural strength (Cox 1974:247). Most ocean-going ships had two decks to ensure adequate longitudinal strength. Second, shallow draft and flat bottoms allowed schooners to visit sawmills located in shallow coves and harbors,



often obstructed by sand bars. These shallow hulls eliminated waiting time for high tide and the need for lightering.

Flat-bottomed schooners were sometimes fitted with retractable centerboards to help counteract leeward drift typical of a shallow-draft hull (Cox 1974:250). The centerboard was retractable so it could be raised when the vessel crossed a sandbar or entered shallow water. Centerboards were common on Great Lakes schooners, but little has been written about West Coast centerboard construction. Historian Thomas Cox has suggested that the practice was limited mostly to small schooners servicing northern California dogholes (small ports) and Oregon's bar harbors, where shallow draft was especially crucial (Cox 1981:68). Evidence based on Hall Brothers' vessels supports this assumption. Of 108 vessels built by the Hall Brothers Shipyard during their 29 years as one of the leading shipyards on the Pacific Coast, only 20 vessels, most two- and three-masted schooners in the 200 to 300-ton range, were built with centerboards (Lyman 1951). The largest centerboard schooner constructed by the Hall Brothers was the 429-ton *Comet*, one of the vessels discussed in this report.

Documents about Great Lakes centerboard use gives additional details about this device. By the mid-nineteenth century, all centerboards operated on a single pivot on the forward edge, as opposed to rising straight up into the centerboard trunk. There were two possibilities in the centerboard placement: through the keel or alongside the keel. During the mid-nineteenth century, Great Lakes builders preferred the offset centerboard, primarily because it offered convenience in stepping the mast (Barkhausen 1990:13). In 1866, the Board of Lake Underwriters, however, adopted a resolution that required through-keel centerboards in all vessels, which probably reflected a change that had already taken place, because it led to

stronger, better quality vessels (Barkhausen 1990:14, 24). West Coast centerboard practice probably followed the same policy, although there is little documentation.

West Coast schooner construction incorporated some features that provided additional longitudinal hull strength, such as large, built-up keelsons; bilge stringers added to the ceiling; and use of thickened ceiling planking to the turn of the bilge (MacGregor 1982:63; Haller and Kelly 1990:16). The keelson was bolted through the floors into the keel. Rider keelsons, of which there could be as many as four, were then bolted directly onto the main keelson. Sister keelsons were placed on both sides of the main keelson, butted up to it and bolted into the floors and horizontally edge-bolted into the main keelson. Finally, a number of assistant keelsons were placed on top of the sister keelsons, bolted to the sister and edge-bolted to the riders (Desmond 1919[1984]:55–56).

The vessels were generally built entirely of Douglas fir, with the exception of the stempost and sternpost, which were of more durable laurel and white oak (Hall 1884:131, 133). Cabins were generally white cedar, pine or redwood (Hall 1884:131, 133). Schooners were typically double framed, fastened with both iron spikes and wooden treenails. Treenails, made from durable and flexible eastern locust or oak, were brought from the East Coast (Olmsted 1972:2; Weinstein 1978:45).

Along with a distinct hull design, West Coast lumber schooners also had a unique schooner rig. Known as "baldheaded" schooners, they often carried only their gaff sails, preferring to run without topsails because "in the long beat to windward of the return trip there were no gafftopsails to shift when tacking" (Weinstein 1978:20). Many lumber schooners were "terns," or vessels with masts of equal height (Bauer 1988:271) (Figure 2.1). Some schooners were

also outfitted with a yard on the foremast to carry a square sail, known as a hermaphrodite rig. This sail, however, was furled into the mast, like a drapery, rather than up to the yard (Olmsted 1972:17). This allowed furling the sail from the deck, so the vessel did not need more sailors than a regular-rigged schooner, although it carried more sail. Some West Coast lumber schooners set a leg-of-mutton sail on the aftermost mast instead of a gaff sail, depending on the personal preference of the master (MacGregor 1982:62).

A typical West Coast lumber schooner carried a crew of eight or nine, including the captain. In the case of the lumber schooner *C. A. Thayer*, preserved at San Francisco Maritime National Historical Park, the crew consisted of four seamen, two mates, a cook and the captain (Olmsted 1972:4). Many lumber schooners, including *C. A. Thayer* and *Comet*, were equipped with steam-powered donkey engines to assist in raising the sails and working the deck machinery and pumps. If a vessel had no steam donkey, the crew would be slightly larger. Crew duties included handling lines, raising and lowering sails, and handling cargo (DeLong 1985:52). For his labor, the sailor received pay and provisions. The Shipping Articles for 1900 listed a mate's pay at \$55 per month, the second mate and cook's pay at \$50 per month, and seaman's pay at \$40 per month. The captain's salary began at \$100 per month, plus a share in the profits of each voyage if he owned an interest in the vessel (DeLong 1985:52). The crew's quarters aboard a lumber schooner were small and spartan, consisting of a six-by-eight-ft. cabin forward of the galley, containing bunks for six. The captain's quarters, located near the stern, were considerably roomier and often richly furnished (DeLong 1985:52) (Figure 2.2).

Lumber schooners were considered to be owned by a single company, although 16 or more individuals often jointly owned vessels; shares in these vessels might be divided into as little as one-sixty-fourths. It was also common for the yard that built the schooner to retain a share of the ownership (DeLong 1985:4).

Loading and discharging lumber from a schooner was time-consuming. Larger mill ports employed stevedores, while at others, loading and unloading was the crew's duty. If the crew was required to do the work, they were typically paid more while in port than at sea. For example, on a 1904 voyage to Honolulu, seamen aboard *C. A. Thayer* were paid \$35 per month while at sea and \$40 per month while in port (Olmsted 1972:15). Even with professional stevedores loading the lumber, however, it was a long process—it took an average of 10 days to load a vessel, plank by plank. In the larger harbors, loading was accomplished using a series of ramps that sloped up from the wharf to the stern and then down into the hold. If the vessel was equipped with bow or stern loading ports, the ramps were sloped up to these. In all cases, after the hold was full and the cargo secure, the rest of the load was piled onto the deck and tightened down with chain and turnbuckles. Deckloads often represented more than half the cargo and often resulted in a 12 to 14-ft. stack of lumber (Weinstein 1978:39). With deckloads that high, little freeboard was left, and the decks were often awash. For a voyage to be profitable, however, such deckloads were required, and they were possible because of the cargo's inherent buoyancy (Cox 1974:248). After introduction of steam donkey engines in the early-1880s, stevedores used a vessel's donkey engine to assist in loading, or if the vessel did not have one, they used an engine on a floating barge brought to the vessel's side (Cox 1974:248).



**Figure 2.2.** Hulda and Otto Lembke aboard *Comet* at Santa Barbara, California, 1905. Photo courtesy of San Francisco Maritime NHP.

### DECLINE OF THE PACIFIC COAST LUMBER SCHOONER

Although sailing schooners were used in the lumber trade up to World War I, the last order for constructing a new sailing schooner was placed in 1905 (Olmsted 1972:5). Growing competition from steam schooners introduced in the 1880s caused the steady decline of its wind-driven predecessor. The result of this competition was that “sailing schooner construction was suddenly pinched off just when it hit its peak” in the early-twentieth century (Olmsted 1972:5).

The first lumber schooners employing steam engines were traditional sail-driven schooners fitted with auxiliary steam machinery around 1880 (Newell and Williamson 1960:61; McNairn and MacMullen 1945:14). Steam-powered schooners were well suited to working

conditions in northern California dogholes, and they were used there first. The first documented vessel built from the keel up as a steam schooner was *Newsboy*, built in 1888 by Boole & Beaton of San Francisco. This vessel ran between Eureka and San Francisco (Newell and Williamson 1960:67; McNairn and MacMullen 1945:17).

As noted before, the change from sail to steam was a slow process and never universal in the West Coast lumber trade. Many ship owners were slow to change, and some, like the well-known Pope and Talbot, never changed (Newell and Williamson 1960:67). Initially, many ship owners were reluctant to switch, for several reasons. There was concern over loss of cargo space both in the hold and on deck due to space needed for machinery and coal (McNairn and MacMullen 1945:15). Another concern was the false belief that steam schooners

could never be economically viable in anything but the short northern California run. This was because early steam schooners had small carrying capacities, and the largest coastal steamers had freight rates prohibitively high to carry lumber (Cox 1974:252). By the 1890s, however, steam schooners were profitably making the run from Puget Sound to southern California, proving critics wrong.

Until the first part of the twentieth century, steam lumber schooners built on the West Coast were “single-ended” (Bauer 1988:278). This meant that steam machinery was near the vessel’s stern, aft of the cargo-handling gear. The first double-ended steam schooner, *Daisy Mitchell*, was built in 1905 by Hans Bendixsen (McNairn and MacMullen 1945:19). This innovation placed steam machinery amidships, allowing cargo to be stowed fore and aft, which significantly increased carrying capacity (Bauer 1988:278).

In the Great Lakes, the consort system of towing lines of schooners with a steam vessel was a popular mode of transporting bulk cargos such as lumber in the late-nineteenth century.

This system never made significant inroads on the West Coast, possibly due to different sailing conditions. Towing was not ignored altogether on the Pacific Coast, however. It was employed to a certain degree on the California redwood coast during the late 1880s and 1890s. Competition from large steam schooners on this run made towing small schooners up the coast, which saved both time and wages, attractive to many small vessel owners (Cox 1974: 252). The practice of towing did not become common on the longer run from Puget Sound.

Wooden vessels involved in the West Coast lumber trade experienced a brief boom during World War I, but this generally marks the end of wooden-hulled vessel use in this trade. Steel-hulled ships soon dominated the market (McNairn and MacMullen 1945:19).

The coastal sailing schooner’s longevity as the primary mode of Pacific Coast lumber transport from mill to market is testimony to this vessel-type’s historical significance. For more than half a century, the lumber schooner was an important part of the Pacific Coast’s lumber-based economy.

## CHAPTER 3

### The Hall Brothers Shipyard and the Schooners *Dora Bluhm*, *Comet* and *J. M. Colman*

---

The Hall Brothers built the schooners *Dora Bluhm*, *Comet* and *J. M. Colman* at their Port Blakely shipyard between 1883 and 1888, at a time when the demand for lumber from southern California was on the rise, increasing the need for coastal lumber schooners. As discussed in Chapter 2, the completion of the Santa Fe Railroad into Los Angeles in 1885 and the resultant real estate boom sparked this increased demand. In addition to needing lumber in the southern California metropolitan area, the newly completed railroad shipped lumber to markets in the southwestern United States. The *Los Angeles Daily Times* on June 10, 1883 noted, “a large number of lumber schooners are reported in the bay at San Pedro, loaded with lumber. The Arizona, New Mexico and Texas trade is constantly increasing, and all the facilities of the lumber companies are taxed to the utmost to keep pace with the demand (*Los Angeles Daily Times* June 10, 1883:4).”

It is within this context that the Hall Brothers produced *Dora Bluhm*, *Comet* and *J. M.*

*Colman*. The three-masted design of the schooners reflected the current trend in lumber schooner construction. Three-masters began to replace the two-masted schooners during the 1870s, and by the 1880s, the three-masters, which could carry up to 600,000 board ft. (bf) of lumber, were dominant in the trade.

#### HALL BROTHERS SHIPYARD

The Hall Brothers of Puget Sound, the shipyard that constructed *Dora Bluhm*, *Comet* and *J. M. Colman*, have been described by one modern historian as “the greatest of . . . all” Pacific Coast shipbuilders (Newell and Williamson 1960:21). Another notes that the “Hall Bros . . . are credited with having brought the sailing lumber schooner to the apex of its development (Bauer 1981:16).” The Hall Brothers’ contribution to the Pacific shipbuilding industry, and the lumber trade, was substantial.

The Hall brothers, Isaac, Winslow G. and Henry K. (referred to as Henry K. to distinguish

him from Henry Hall, the author, who is cited throughout this report), hailed from Cohasset, Massachusetts (Lyman 1951: 97). They were raised in a family that had strong ties with the sea, and their father George Hall ran a Boston-Cohasset packet in the late 1820s (Lyman 1952:109). The Halls apprenticed in Cohasset and Medford, Massachusetts, where they became master carpenters, and in 1848, Isaac began a shipbuilding business in Cohasset, which Henry K. later joined (Lyman 1951:97; Lyman 1952:109). They constructed several vessels, including the 787-ton ship *Greenwich*, which was their largest (Lyman 1952:109). Meanwhile, the third brother Winslow learned the caulking trade and studied naval architecture (McDonald 1978: 100; Lyman 1952:109).

During the American Civil War, the three Hall brothers left New England for California, where they began building coastal schooners (Lyman 1952:110). Between 1863 and 1869, Isaac and Winslow built three two-masted schooners in San Francisco: *Sarah Louise*, *California* and *Stranger* (Lyman 1951:97). In 1873, Isaac went to Port Ludlow on Puget Sound with a contract to build a vessel for San Francisco interests. This vessel, the 107-ton schooner *Z. B. Heywood*, was the first Hall-built vessel constructed on Puget Sound (Hall 1884:133). Soon after, Isaac returned to San Francisco and convinced his brother Winslow to join him in a new shipbuilding enterprise. Winslow remained in San Francisco to work on designs, arrange contracts and obtain sails, fastenings, cordage and other items necessary in ship construction not available in the Pacific Northwest, while Isaac returned to Port Ludlow to manage the shipyard (Lyman 1951:97). The first vessel they completed was the 155-ton, two-masted schooner *Annie Gee*, the first of five vessels built by the Halls in 1874. In 1875, Isaac and Winslow's younger brother Henry K. Hall joined the partnership and began to work with

Isaac at the Port Ludlow yard. In that year, the Halls built their first of many three-masted schooners, *Emma Utter* (Lyman 1951:97–98).

The Hall brothers soon gained a reputation for quality work. An 1876 newspaper clipping from Washington Territory noted that:

Besides being one of the pleasantest mill towns in the territory, Port Ludlow is acquiring a high reputation for shipbuilding, Messrs. Hall Brothers having built 13 vessels there. . . . The vessels built by this firm are used in the coasting trade and rank among the best on this coast [McDonald 1978:101].

Several milestones occurred in the Hall Brothers' business during 1876. First, they built the three-masted schooner *Reporter*, in which they retained ownership interests (Lyman 1951: 98). This was the first of many vessels built by the Hall Brothers in which they retained an interest. They also constructed their largest vessel to date on the West Coast, a 423-ton barkentine called *Quickstep* (Lyman 1951:97). In addition to being the largest, it was also the first non-schooner-rigged vessel built by the Halls on the West Coast. They retained ownership in this vessel, as well.

Isaac Hall died in 1879, and Henry K. became the manager of the Port Ludlow yard (Lyman 1951:98). The following year the closure of the Port Ludlow lumber mill forced the Hall Brothers to relocate to be near another mill, a convenient lumber source. Their seven years at Port Ludlow had been productive, however, with 31 vessels completed totaling 6,365 tons. These included 15 lumber schooners, eight "Sandwich [Hawaiian] Island schooners," four barkentines, two steamers, a pilot boat and a yacht (Hall 1884:135).

At the end of 1880, the Hall Brothers chose Port Blakely, also in Puget Sound, as their new location. The site was next to the Port Blakely

Mill Company, owned by Renton, Holmes and Company (Lyman 1951:99) (Figures 3.1 and 3.2). Renton promised to supply the Hall Brothers with lumber at a reasonable price, and even built a “set of wooden tracks shod with strap iron” at his (Renton’s) expense to carry the lumber one-quarter mile to the shipyard (Weinstein 1978:43). On his visit to Port Blakely in December 1881, Henry Hall (the author) noted that the shipyard and the lumber mill were the only industries in Port Blakely (Lyman 1945:85).

In his 1884 *Report on the Shipbuilding Industry in the United States*, Hall discussed the Hall Brothers Shipyard at length. He pointed out, “[t]he owners have fitted up the . . . yard at considerable expense, and have sent a delegate to Bath, Maine, to report on the labor-saving appliances there employed and to purchase steam saws, planers, and a full equipment for their yard (Hall 1884:135).” According to Hall, the average cost of a vessel built by the Hall Brothers was \$70 per register ton, “but in consequence of good management and the use of machinery this cost is being steadily reduced, and it is now not in excess of the cost of vessels of similar sizes on the Atlantic coast (Hall 1884:135).” In discussing the price of lumber at the Hall Brothers Shipyard, Hall mentioned that:

For keelson pieces over 90 ft. in length they [the Hall Bros.] pay \$16 a thousand; for less than 90 feet, \$11 a thousand; for bed logs for center-board schooners and rough, clear lumber for stanchions, \$16; planking clear of heart and knots, \$12; deck plank, planed, \$22.50; for all the rest of the material in the ship, \$11; but the average of the vessel does not exceed \$12, and the average length of stuff is 20 ft. more than that of eastern yards [Hall 1884:135].

Hall described the Hall Brothers’ schooners as “fast, handsome, and popular, and have long, sharp bows. . . . There is not a straight line on the surface of the hulls anywhere (Hall 1884: 135).”

Hall also credited the Hall Brothers with several innovations in lumber schooner construction. In his notebook, Hall described a barkentine under construction during his visit and noted, “the rudder post projects below the planking, an idea of the Hall Brothers (Lyman 1945: 87).” In addition, he mentioned that the barkentine had a “breast hook over the [lumber] ports forward, an idea of the Halls, now required in all vessels here (Lyman 1945:87).”

Regarding payment, the Hall Brothers were probably typical of most West Coast builders. Henry Hall noted that payment for vessels under construction usually took place in four installments: one-quarter when the frames were up, one-quarter when ceiling and deck-frames were in, one-quarter when the vessel was planked and decked, and one-quarter when completely finished. Sometimes the builder would receive a small amount when the contract was signed, but this was unusual (Hall 1884:133).

For more than 20 years, the Hall Brothers Shipyard remained an important part of the Port Blakely community. Not only did they provide employment for a variety of tradesmen and a steady market for lumber from the Port Blakely mill, they also created investment opportunities for men in both the shipping and lumber industry (Weinstein 1978:45). In addition, one scholar noted the “frequent launchings of their ships provided gala social occasions for the tiny Blakely community. Offering rare relaxation these launchings attracted the entire small population free to attend them. . . (Weinstein 1978:45).”

In 1898, Winslow G. Hall died in San Francisco, and managerial duties there were



**Figure 3.1.** Map of Blakely Harbor, Washington, 1894. Courtesy of San Francisco Maritime NHP, Harold Huycke Collection, F10.7,486n.



**Figure 3.2.** Hall Brothers Shipyard, Port Blakely, Washington, 1899. Courtesy of San Francisco Maritime NHP, Wilhelm Hester Collection, F17.20,149nl.



turned over to George E. Billings, the husband of the Hall brothers' niece, Maria (Lyman 1951:99). He continued in that capacity until 1903, when he took over as full-time manager of the Halls' shipping fleet. Henry K. Hall retired from active management of the shipyard in 1902, following completion of the five-masted schooner bearing his name (Lyman 1951:100). At this time, Henry K.'s son James Hall became manager. Finally, in 1903, after completing the 1,260-ton, five-masted schooner *George E. Billings*, the largest vessel built by the Hall Brothers, the yard was reorganized under new owners and moved to Eagle Harbor on Bainbridge Island (Lyman 1951:100). The new yard was called the Hall Brothers Marine Railway and Shipbuilding Company, and James Hall remained the manager (Lyman 1951:100). James Hall was soon replaced, however, and in 1904 the shipyard passed from family hands.

During their 22 years at Port Blakely (1881–1903), the Hall Brothers built 77 vessels, which, when added to the 31 constructed at Port Ludlow, brings the total number of vessels completed at both yards to 108. This included 82 schooners (16 two-masters, 23 three-masters, 40 four-masters and 3 five-masters) for the coastal lumber trade, Sandwich (Hawaiian) Island trade and Pacific lumber trade (McDonald 1978:106–107). Historian John Lyman notes that between 1877 and 1898, the Halls built 18 sailing vessels and steamers for Hawaiian Island use, so it is likely that many of the schooners built by the Hall Brothers, with the exception of the five-masters, were used in the coastal lumber trade (Lyman 1951:98). At its height, Henry Hall described the Hall Brothers Shipyard as having “more contracts than they want (Lyman 1945:87),” and Alan H. MacDonald, who worked for the Hall Brothers as a youth, remarked that the builders often had three vessels on the stocks at one time (Weinstein 1978:45). There is no doubt that the Hall

Brothers' contribution to the maritime industries of the Pacific Coast was great. The quality of their vessels was often noted, and their reputation on the West Coast was unsurpassed.

## VESSEL HISTORIES

### SCHOONER *DORA BLUHM*

The schooner *Dora Bluhm* was launched in March 1883. The first Certificate of Registry, dated April 30, 1883, records that the vessel had one deck, three masts, a billet head and an elliptic stern. It was 133.7 ft. long, 33.3 ft. wide, 10.5 ft. deep and totaled 315.51 net tons (National Archives, Washington D.C. [NA], Record Group 41 [RG 41], Records of the Bureau of Marine Inspection and Navigation, Certificate of Registry Number 33, 1883). The fore-, main- and mizzenmasts all measured 90 ft. in length, and each had 47-ft. topmasts (J. Porter Shaw Library, San Francisco [JPSL], Hall Brothers Shipyard Contract Number 40, 1883). During construction, the vessel was known simply as Hull Number 40.

The existing original contract for *Dora Bluhm* gives details concerning the vessel's construction and fitting (JPSL 1883). The contract specifies all timber dimensions for the schooner, as well as the fastener size for each component. This information is especially useful for comparative analysis and identification of vessel remains (see Chapter 4). *Dora Bluhm* was constructed entirely of Douglas fir, with the exception of stempost and sternpost, which were “hardwood.” The contract indicates that *Dora Bluhm* was equipped with a centerboard, and bow and stern ports for loading lumber. The contract also notes information on caulking and painting, indicating *Dora Bluhm*'s bottom was painted with two coats of “Tar and Wonson's copper paint.” In addition, the vessel was fitted with “composition rudder braces, diamond-cut

screw steering gear, 24-in. windlass purchase and double-gear No. 3 capstan.” The contract also specifies number and size of anchors, chain, and rope, as well as furniture, fixtures and ship’s boats. It notes that the vessel was “to be fitted for sea with . . . all equipments for a coasting voyage with the exception of provisions.” For this, the owners agreed to pay \$27,500 in US Gold Coin over four installments (JPSL 1883).

The first registry records 10 original owners for *Dora Bluhm*, most from San Francisco, with William G. Bluhm, also the master, owning the largest share (one-quarter); Winslow G. Hall retained a one-sixteenth share of the vessel. The schooner was originally registered at Port Townsend, Washington (NA 1883:RG 41:Registry 33).

Over the course of its career, *Dora Bluhm* changed enrollments and registrations 36 times. A complete listing of the documents of enrollment and registration for the schooner *Dora Bluhm* are found in Appendix A. The most obvious characteristic of this listing is that the vessel changed from enrollment to registration, and back, frequently, often with the explanation “change of trade.” Since Certificates of Enrollment were required for vessels involved in domestic trade, and Certificates of Registration were required for vessels in the foreign trade, the most logical explanation is that *Dora Bluhm* frequently took cargoes of lumber to Mexico, or even further south, to Central or South America. The resolution of South American conflicts in the early 1880s created markets in both Peru and Chile as those nations expanded railroad construction (Cox 1974:215). In addition, Mexican markets expanded during the 1880s and early 1890s (Cox 1974:221). Contemporary newspaper records indicate lumber schooners often made voyages south of the border.

The original registry was surrendered on May 29, 1883, and a Certificate of Enrollment

was issued at San Francisco, *Dora Bluhm*’s new home port (NA 1883:RG 41:Enrollment 333). During the first years of its career, the vessel’s home port changed several times between San Francisco and Port Townsend. No other changes were recorded in its first four years of service. Presumably, the vessel was actively involved in the coastal lumber trade during this entire period. However, on March 23, 1887, Henry Moore replaced William G. Bluhm as *Dora Bluhm*’s master and took a one-eighth share of the vessel, with Bluhm retaining a one-sixteenth interest (NA 1887:RG 41:Enrollment 154). Moore remained master for three and a half years, until October 6, 1890, when Frank E. Rensch took over both Moore’s one-eighth share of the schooner and command of the vessel (NA 1890:RG 41:Enrollment 62). Several months later, on March 13, 1891, this was repeated as Roger Walton replaced Rensch as *Dora Bluhm*’s master and one-eighth owner (NA 1891:RG 41:Enrollment 145). Although no further major changes in ownership or command occurred until 1894, it is interesting to note that on January 25, 1892, Winslow Hall split his interest in the schooner with his brother Henry K. Hall, giving them both a one-thirty-second interest in the vessel (NA 1892:RG 41:Registry 60).

The schooner ran into its first major mishap in November 1892. The *San Francisco Chronicle* of November 23, 1892, carried the headline “THE DORA BLUHM LOST ON THE MEXICAN COAST.” The article went on to say:

The schooner *Dora Bluhm* was wrecked a week ago near Topolobampo, on the Mexican coast, during a storm. The crew were saved. The first intimation of the disaster reached here yesterday in a dispatch from Captain Walton to W. H. Smith, the managing owner of the

schooner. The vessel, which was driven on the rocks during a gale, is likely to prove a total loss, as well as the cargo of 300,000 feet of lumber. There was no insurance on the cargo, but local companies have risks on the vessel. The *Bluhm* left here on August 26th for Gray's harbor to load lumber for Mexico. . . [*San Francisco Chronicle*, November 23, 1892:12].

This is significant because it shows that *Dora Bluhm*, sailing under a Certificate of Registration, was actively involved in carrying lumber to Mexico. It is therefore reasonable to assume that the nine previous Certificates of Registration were also issued before foreign voyages.

Contrary to the statement in the *Chronicle*, *Dora Bluhm* was refloated and towed to San Francisco, where it was laid up in Oakland Creek until August 1894 (Martin 1983:236–237). The *Daily Humboldt Times* reported in July of that year that shipbuilder Hans D. Bendixsen, of Eureka, California, purchased the vessel while on a trip to San Francisco (Martin 1983:237). *Dora Bluhm* was towed to Humboldt Bay, arriving there on August 2, 1894:

**THE WRECK ARRIVES.** The tug *Vigilant*, with the schooner *Dora Bluhm* in tow, arrived off the bar about noon yesterday, where she was met by the tug H. H. Buhne and relieved of her tow. There were eight men aboard the schooner and it took some time to transfer these to the *Vigilant* . . . This done, the *Vigilant* put about and headed for San Francisco and the H. H. Buhne brought the schooner into the bay dropping her at Bendixsen's shipyard. The *Dora Bluhm* has very little the appearance of being a condemned

wreck. With the exception of her fore-topmast, her spars and rigging are intact, she is not waterlogged and above the waterline does not seem to be injured in the least. In fact, her injuries are all on the bottom, principally to her keel. It is said that Mr. Bendixsen paid \$2000 for her and in that case has secured a great bargain. The probable reasons for the owners selling her this cheaply is the fact that it had cost them about \$20,000 to float her and bring her to San Francisco from the Mexican coast where she was wrecked in 1892, and they did not care to expend any more money on her. She has been in Oakland Creek about two years and as there was very little demand for vessels of her size it was not thought profitable to repair her [Martin 1983:237].

As alluded to in the article, four-masted schooners had begun to take over the coastal lumber trade in the late 1880s. The real estate boom in southern California ended by 1890 and demand for lumber diminished, so the number of three-masters in the trade declined.

Bendixsen repaired the damaged *Dora Bluhm*, and it sailed again on October 29, 1894 (Martin 1983:243). This major change of ownership is reflected in the Certificate of Enrollment issued August 2, 1894. In it, the owners are listed as Jacob B. Levinson (five-eighths), Sun Insurance Co. (one-eighth), Edward Lycan (one-eighth), and William Huntoon (one-eighth); Huntoon was the only original investor to retain an interest. Levinson is listed as the master, but was replaced by Peter Rice on October 18, 1894 (NA 1894:RG 41:Enrollment 22). Bendixsen himself does not appear as an owner until a new Certificate of Registry is issued February 5, 1895. At this time eleven new investors took the place of the

previous owners, with Bendixsen owning one-quarter interest and Rice, the master, owning a one-eighth interest (NA 1895:RG 41:Registry 65). It is unknown why there is a discrepancy between the documents of enrollment and the newspaper account. It is possible that Levinson, Lycan and the Sun Insurance Company purchased *Dora Bluhm* for Bendixsen and his group of investors.

Rice remained the schooner's master until October 15, 1895, when O. C. Larsen replaced him, but Rice retained an interest in the vessel until August 22, 1896 (NA 1895:RG 41:Enrollment 1; NA 1896:RG 41:Enrollment 34). Larsen gained a one-sixteenth interest in *Dora Bluhm* on March 8, 1897, and gave it up, along with his command of the schooner, one year later, on March 16, 1898, when E. C. Olsen became master and one-sixteenth owner (NA 1897:RG 41:Enrollment 167; NA 1898:RG 41:Enrollment 203). This new arrangement lasted slightly more than a year, until April 19, 1899, when N. F. D. Jorgensen replaced Olsen as master and one-sixteenth owner (NA 1899:RG 41:Enrollment 244).

It was during this period that *Dora Bluhm* suffered another mishap. On November 15, 1898, while on a voyage from San Pedro to Seattle with a load of crude oil, *Dora Bluhm* collided with the steamer *Dora* southeast of Cape Flattery, Washington (National Archives, Pacific Sierra Region [NA-PSR], Record Group 36, Records of the US Life-Saving Service, Wreck Report 27, 1898). Damage was not specified, but was estimated at only \$142. This is the only reference discovered that mentions a lumber schooner carrying crude oil, obviously not a common practice.

While at San Pedro, on June 12, 1899, Haldor Smith replaced Jorgensen as master, and on December 29, 1899, as one-sixteenth owner of *Dora Bluhm* (NA 1899:RG 41:Enrollment 244; NA 1899:RG 41:Registry 50). Beginning

with Enrollment Number 112, on October 28, 1901, the schooner underwent a rash of unexplained owner and master changes, until becoming property of the Pacific States Trading Company on November 11, 1905 (NA 1905:RG 41:Enrollment 88). *Dora Bluhm* remained property of Pacific States Trading until it wrecked on Santa Rosa Island in 1910, after four more changes in masters.

A complete record of *Dora Bluhm*'s voyages from 1903 until its 1910 loss is part of the San Francisco Marine Exchange's records of vessel transit. The record provides a general pattern of the schooner's activity. Between 1903 and 1910, *Dora Bluhm* most frequently carried lumber to San Pedro, although it occasionally called on San Diego, Redondo Beach, Ventura, and San Francisco. Its ports of origin were most frequently Eureka and Grays Harbor, but it also sailed from Astoria, Seattle and Coos Bay (JPSL:Records of Vessel Transit, 1903–1910). The fact that San Pedro was the most common port of call reflects a second southern California real estate boom in the first part of the twentieth century, when demand for lumber once again increased markedly. For example, the *Los Angeles Daily Times* on October 18, 1905, reported San Pedro's largest shipping day in history, with 40 vessels unloading cargos and another 16 waiting to unload. The article noted "The sixteen vessels which lay in the outer harbor yesterday morning were all carrying full cargoes of lumber. They floated fully 15,000,000 feet . . . (*Los Angeles Daily Times*, October 18, 1905:1)."

Interestingly, some of *Dora Bluhm*'s voyages during this time include fishing. From May 2 to September 11, 1906, and from April 14 to September 20, 1907, *Dora Bluhm* was codfishing in the Bering Sea. This was a common fate for sailing lumber schooners as steamers slowly pushed them out of the coastal trade. Schooners were used because they were

large, inexpensive and easy to handle. They often served as “mother ships,” which carried dories that a crew of 25 to 30 men used to fish each day, then returned to the schooner in the evening to clean and salt their catch (Olmsted 1972:2, 8; DeLong 1985:2). The vessels generally left in the spring, and stayed in the Bering Sea codfishing grounds until they were full of fish or until the onset of winter.

The year 1907 proved to be costly for *Dora Bluhm*, with two accidents recorded within three months. On March 11, 1907, while entering San Francisco Bay with lumber from Rainier, Oregon, the schooner collided with the ship *Dirigo* (NA-PSR 1907:RG 36:Wreck Report 151). As *Dora Bluhm* was passing the other ship, which was anchored off Meiggs Wharf, the winds died, the schooner’s steering gear fouled, and a strong tide carried it into *Dirigo*. Damage to *Dora Bluhm* was estimated at \$600, which included a started bowsprit and loss of the schooner’s jibboom and headgear. *Dirigo* had its windlass carried away and suffered minor damage to its fore-rigging. Two months later on May 5, 1907, while codfishing in the Bering Sea, *Dora Bluhm* was caught in a gale with high seas and 45-mile-per-hour winds. The vessel suffered the loss of its head stays (estimated at \$300) and one crew member, 46-year-old Joseph Wright of Massachusetts (NA-PSR 1907:RG 36:Wreck Report 67). This was *Dora Bluhm*’s final accident until its loss three years later.

The *Record of American and Foreign Shipping*, 1907 edition, notes that *Dora Bluhm* was caulked from keel to deck in August 1889, and in May 1898 it was docked and salted (American Shipmaster’s Association 1907:461). Salting was a common Pacific Coast practice that consisted of filling the open spaces between frames, underneath the ceiling, with rock salt. This prevented dry rot and helped the timber resist decay. It was thought to be so effective

that insurance classification societies added one or two years to a vessel’s classification if salted (Desmond 1919[1984]:103).

Before its final voyage from Coos Bay, *Dora Bluhm* sailed from San Francisco to Magdalena Bay, where it spent almost two months. This voyage’s purpose is unrecorded, but the vessel returned to San Francisco in March 1910, where it was chartered for a voyage from Coos Bay to San Pedro. This was *Dora Bluhm*’s last voyage.

### SCHOONER *COMET*

The schooner *Comet* was launched from the Hall Brothers’ Port Blakely yard in October 1886 (Figures 3.3 and 3.4). Once again, the original contract for the vessel survives, giving a complete record of construction. *Comet* had a length of 136.0 ft. on the keel, 144.6 ft. overall, with a breadth of 35.2 ft., a depth of 11.4 ft., and registered 429.74 gross and 408.26 net tons (JPSL:Hall Brothers Shipyard Contract Number 49, 1886; NA 1886:RG 41:Registry 18). Like *Dora Bluhm*, it had one deck, three masts, a billet head and an elliptic stern (NA 1886:RG 41:Registry 18). It was constructed entirely of Douglas fir, again with the exception of the stempost and sternpost, which were “hardwood (JPSL 1886).” *Comet* was entirely iron fastened, with the addition of 1¼-in. locust treenails on the outer hull planking. The vessel was also equipped with a centerboard, and, like *Dora Bluhm*, had bow and stern ports for loading and unloading lumber. During construction, *Comet* was “salted from lower edge of wales to deck.” The rest of the fitting out and furniture was exactly the same as *Dora Bluhm*, down to the 24 in. windlass purchase and Number 3 capstan. For this vessel, the Hooper Brothers of San Francisco and C. F. S. Lass of Oakland agreed to pay \$30,000 in US Gold Coin, over four installments (JPSL 1886).



**Figure 3.3.** Schooner *Comet* docked at San Pedro, California. Photo by William Phelps, courtesy of San Francisco Maritime NHP.

*Comet*'s first registration records Lass as master, and J. A. Hooper, and F. P. Hooper each owning one-third of the vessel (NA 1886:RG 41:Registry 18). The Hooper Brothers owned interest in several lumber companies, as well as shares in a fleet of lumber schooners, and were well known in the West Coast lumber industry. One reason for owning partial shares in many vessels was to minimize risk. As a result, owners were often willing to forego insurance. It was noted of John A. Hooper "because of his diversified partial interest in so many vessels, the insurance companies were losers, as far as he was concerned, in premium collections over a long period of years. He 'carried his own insurance . . . (Drury 1952:53).'"

*Comet* was originally registered at Port Townsend, Washington, on October 19, 1886. The Hooper Brothers and Lass remained the vessel's owners for its entire life, with various

masters occasionally gaining small interests in the schooner. Although the owners remained the same for *Comet*'s entire career, it was variously registered at Port Townsend, San Francisco, Eureka, San Diego, Port Angeles (Washington) and Los Angeles. Masters changed several times over the vessel's career, the most notable being F. E. Rensch from June 9 to July 16, 1904 (NA 1904:RG 41:Enrollment 16). This is the same Frank E. Rensch that commanded *Dora Bluhm* for a short time in 1890–91. Nicolas Borgenson was captain of *Comet* for two major mishaps that occurred during its career, including its loss in August 1911 (NA 1910:RG 41:Enrollment 6; NA 1910:RG 41:Enrollment 261).

*Comet* was actively involved in the coastal lumber trade for the duration of its 25-year career. Newspaper accounts from December and January 1892–93, as well as San Pedro port



**Figure 3.4.** *Comet* at Santa Barbara, California, 1904. Photo courtesy of San Francisco Maritime NHP.

records from 1895–96 show that *Comet* frequently called on San Pedro from Puget Sound during this period (*San Francisco Chronicle*, December 17, 1892–January 25, 1893; Marquez 1975:127–128). Unlike *Dora Bluhm*, *Comet* was only issued Certificates of Registration three times during its career, all before 1895. Presumably, it did not make voyages south of the border as frequently as *Dora Bluhm*. In addition to records from the mid-1890s, the vessel transit records of the San Francisco Marine Exchange record *Comet*'s voyages from 1903 to its loss in 1911. These records show that San Pedro and Santa Barbara were the vessel's most frequent destination, with occasional stops at San Francisco. Its most common port of origin was Aberdeen/Grays Harbor, but it also sailed from Port Blakely, Port Gamble, Port Townsend and Port Hadlock (JPSL:Records of Vessel Transit, 1903–1911).

Tonnage changes were noted for *Comet* on May 7, 1896, at Port Townsend, Washington. Enrollment Number 16 notes that the changes were made under the Act of March 2, 1895, which reduced net tonnage to 378 (NA 1896:RG 41:Enrollment 16). Enrollment Number 151, on February 23, 1905, further reduced net tonnage to 368, deducting 60.91 tons from the gross tonnage of 429 for crew space (25.86), master's cabin (14.89), boatswain's stores (5.96), storage of sails (5.96), and donkey engine and boiler (8.24) (NA 1905:RG 41:Enrollment 151). Although the construction contract specified that the forecastle be adapted for a donkey engine, this is the first time that one was mentioned on board *Comet*. Since it was not noted on the original contract, the schooner was presumably not originally equipped with one.

Four mishaps are recorded during *Comet*'s career before its loss in 1911. The first occurred in Puget Sound on January 2, 1902 (NA-PSR 1902:RG 36:Wreck Report). *Comet* was sailing to Port Blakely from San Pedro with an empty hold when the steamer *Rainier* ran it down.

Although damage was estimated at \$5,000, the specifics were not noted. The damage was severe enough, however, that the schooner had to be towed to Port Townsend by *Rainier*.

*Comet*'s second recorded accident occurred on February 5, 1905, while anchored at Santa Barbara (NA-PSR 1905:RG 36:Wreck Report 169). The schooner's anchor chain parted during a storm and the vessel crashed into the Santa Barbara Wharf. *Comet* suffered \$1,000 in damage, but fortunately did not damage any other vessels.

Few details are known about the third mishap involving *Comet*. This occurred on March 3, 1907, when the schooner collided with the bark *General Faidherbs* at San Francisco (NA 1907:RG 36, Wreck Reports of the Point Reyes Lifesaving Station, 1898–1915). The damage incurred by *Comet* is unknown.

*Comet*'s fourth accident occurred in February 1911, at San Francisco. On February 28, 1911, the *San Francisco Call* reported that the schooner *Comet* collided with the launch *John A*, sinking the launch and drowning the two occupants (*San Francisco Call*, February 28, 1911:30). Two days later, the *Call* ran the headline "CAPTAIN OF COMET ERRATIC IN ORBIT," and claimed Borgenson, the vessel's master, had given a false position for the accident (*San Francisco Call*, March 2, 1911:12). The article reported that the position given by Borgenson was more than a mile from water deep enough for *Comet*, and that the master "had either made a careless mistake or performed a miracle." The report went on to say that:

When the accident occurred Borgeson [sic] was on his way to sea under sail. A full gale was blowing at the time and in attempting the handling of a three masted schooner under canvas in a crowded harbor with weather conditions as they were on Saturday it is the general



opinion that Captain Borgeson was taking liberties with the law of common sense [*San Francisco Call*, March 2, 1911:12].

Borgeson briefly stopped to report the accident to the managing owner of *Comet*, J. A. Hooper, and proceeded to sea, without giving an accurate account of the accident. The newspaper noted that “this is the first time on record that the captain of the boat that did the running down went to sea without giving the owner of the sunken boat at least an approximate bearing which would aid him in recovering his property (*San Francisco Call*, March 2, 1911:12).” There was no further report of the incident. The next time *Comet* made headlines, it had wrecked on San Miguel Island.

#### SCHOONER *J. M. COLMAN*

The Hall Brothers launched the schooner *J. M. Colman* in April 1888 (Figures 3.5 and 3.6). The vessel measured 157.0 ft. long, 37.0 ft. in breadth, 11.3 ft. deep, 471.95 gross tons, and 448.36 net tons. Like the other two schooners, it had one deck, three masts, a billet head and an elliptic stern (NA 1888:RG 41:Enrollment 43). It was built for J. J. McKinnon of San Francisco, who was the sole owner. Unfortunately, *J. M. Colman*'s original contract has not been located, but a hand-written ledger sheet indicates the vessel was originally known as Hull Number 56, and was built for \$33,286.84 (JPSL, Hall Brothers Shipyard Ledger Sheet Number 56, 1888). *J. M. Colman* was one of the largest three-masted schooners built on the coast, registering only 13 gross tons less than the largest, *W. F. Jewett* (Haller and Kelly 1990:22). The first master of *J. M. Colman* was C. H. Atwood (NA 1888:RG 41:Enrollment 43).

Shortly after the first enrollment, *J. M. Colman* moved to San Francisco and McKinnon

shifted half the interest in the vessel to Preston and McKinnon (seven-sixteenths) and John Simpson (one-sixteenth). Atwood remained master until November 10, 1890, when William Treanor took the helm (NA 1890:RG 41:Enrollment 43). Treanor remained in command of the schooner until 1899 and one-eighth owner until 1901. In 1897, McKinnon again reduced his interest in *J. M. Colman*, to one-quarter, selling a one-eighth interest to C. A. Hooper and a three-sixteenths share to the Puget Sound Commercial Company of Port Gamble, among others (NA 1897:RG 41:Enrollment 120). C. A. Hooper was also one of the principal owners of *Comet* for its entire career.

Like *Comet*, *J. M. Colman* was active in the coastal lumber trade for the duration of its career. Newspaper accounts from 1892–93 indicate that *J. M. Colman* made regular voyages between Grays Harbor and San Francisco (*San Francisco Chronicle*, November 16, 1892–February 14, 1893). Los Angeles port records from 1895 indicate that the schooner called on San Pedro often, as well (Marquez 1975:127–128).

A tonnage change was noted on the Certificate of Enrollment issued August 22, 1899 (NA 1899:RG 41:Enrollment 30). Of 463 gross tons, 73.93 were deducted for a net tonnage of 389. Like *Comet*, 8.04 tons were deducted for a donkey engine and boiler. Since the original contract does not exist, it is not known whether *J. M. Colman* was originally equipped with a steam donkey. Enrollment Number 30 is the first mention of a donkey engine on board the schooner.

The Certificate of Registry from September 26, 1899, shows that J. J. McKinnon, original owner of *J. M. Colman*, sold his remaining interest in the vessel. At that time, Julia Simpson (one-sixteenth) and James M. Colman (one-quarter) were added to the list of owners (NA 1899:RG 41:Registry 16). There is no information available on Colman, though it is



**Figure 3.5.** The schooner *J. M. Colman* about 1900, photographed off Cape Flattery or in the Straits of Juan de Fuca. *J. M. Colman* was built by the Hall Brothers Shipyard, who also built *Comet*. Photo by Hiram Hudson Morrison, courtesy of San Francisco Maritime NHP.



**Figure 3.6.** *J. M. Colman* in port at San Pedro, California. Photo courtesy of San Francisco Maritime NHP.

likely that the vessel was named for him. Masters changed frequently during this period, until August 31, 1900, when Charles Peterson took command of the vessel at Tacoma, Washington (NA 1900:RG 41:Enrollment 313). Peterson remained master of *J. M. Colman* until its loss on San Miguel Island in 1905.

Ownership of the schooner changed hands for the last time on June 27, 1901, when the Pacific Shipping Company of San Francisco became the vessel's sole owner. Little is known about this company. The 1904–05 *Lloyd's Register of Shipping* mentions C. A. Hooper and Co. of San Francisco as the "operating agents" for *J. M. Colman* (Haller and Kelly 1990:22). It is not known whether Hooper had an interest in the Pacific Shipping Company. To add to the confusion, when reporting the wreck of *J. M. Colman*, the *Los Angeles Daily Times* indicated the vessel was owned by the Hooper Brothers, who "compose the Pacific Lumber Company and are the largest stockholders in the San Pedro Lumber Company and Southern California Lumber Company (*Los Angeles Daily Times*, September 7, 1905:9)."

Once again, data from the San Francisco Marine Exchange fills in the last years of the vessel's life. Record cards indicate that *J. M. Colman* hauled lumber to San Pedro, Redondo Beach and San Francisco in its last years. The cargos were loaded at Port Gamble, Aberdeen/Grays Harbor, Port Ludlow, Astoria, Port Townsend and Everett. Sailing time on the southbound trip to southern California averaged about two weeks, while the return trip to Puget Sound took about twice as long (JPSL:Records of Vessel Transit, 1903–1905).

Haller and Kelly discuss one other mishap that befell *J. M. Colman* before its loss in 1905. They note the San Francisco Marine Exchange records that the vessel entered dry dock in April 1902 at Port Townsend, Washington with a "rudder stock twisted and gudgeons gone . . .

(Haller and Kelly 1990:22)." The nature of the accident is not discussed, and no other accidents are known until the vessel wrecked on San Miguel Island in September 1905.

The hazards of the Santa Barbara Channel claimed these three Hall-built schooners within a six-year period, 1905 to 1911. Although each vessel had made the same voyage dozens of times, some factor, natural or human, affected their last voyages, with disastrous results.

## WRECK EVENTS

### SCHOONER *J. M. COLMAN*

*J. M. Colman* was the first lost in the Santa Barbara Channel. On August 26, 1905, the vessel departed Everett, Washington, bound for San Pedro with 600,000 bf of lumber (*Los Angeles Daily Times*, September 7, 1905:9). The familiar voyage began normally, as it had numerous times. About six days out, sometime on Saturday, September 1, the schooner entered a thick fog and was forced to steer by dead reckoning alone. Then, without warning on Sunday evening, September 2, 1905, *J. M. Colman* struck San Miguel Island. The schooner's first mate, Frank Patterson, described the disaster:

About 10 o'clock Sunday night, while sailing before the wind, at about nine miles an hour, in one of the thickest fogs I ever experienced, we suddenly struck a rocky reef on the sothwesterly [sic] shore of San Miguel Island. Before the accident we had not seen the sun for thirty-six hours, so thick was the weather, and had to sali [sic] by dead reckoning. After striking, the Coleman [sic] ground and pounded her way over the first reef, sinking down into deeper water between where she first struck and

another reef, farther inshore [*Los Angeles Daily Times*, September 7, 1905:9].

Fortunately, none of the 10-member crew was injured in the accident (*Los Angeles Daily Times*, September 7, 1905:9). After the vessel grounded, Patterson and four sailors took the ship's boat and set out for Santa Barbara for assistance. Captain Charles Peterson and the remaining four crew members stayed with *J. M. Colman*. The steamer *Mandalay* picked up Patterson and the others in mid-channel and took them to San Pedro, where they delivered the first report of the wreck (*Los Angeles Daily Times*, September 7, 1905:9). Patterson reported the schooner's condition:

She is certainly very badly damaged and I doubt whether she can be saved. The lumber cargo can probably be taken off. She is in no immediate danger, as the prevailing west wind will not damage her and there is but little fear of the wind shifting to the southwest at this season of the year. After striking she filled rapidly. She is only kept afloat by her lumber cargo . . . [*Los Angeles Daily Times*, September 7, 1905:9].

A *Los Angeles Daily Times* article reported *J. M. Colman's* value at \$20,000 and the lumber cargo at \$10,000. Both the initial reports in the *Times* and the *San Francisco Chronicle* speculated that the vessel would go to pieces and be a total loss (*Los Angeles Daily Times*, September 7, 1905:9; *San Francisco Chronicle*, September 7, 1905:3). Nonetheless, the tug *Seawitch* from San Pedro and the steamer *Chehalis* from San Francisco were dispatched to render aid (*San Francisco Chronicle*, September 7, 1905:3).

After leaving San Pedro, Patterson and the crew traveled to Santa Barbara, where they

chartered Captain Ira Eaton's vessel *Irene* to take supplies out to their shipmates on board *J. M. Colman* (Eaton 1980:24). According to the story, when Eaton arrived at the wrecked schooner, he found Captain Peterson very upset because the "second mate had dived down after a chest of gold that had sunk when the ship hit the reef, and he had never come to the surface again. They supposed he must have drowned (Eaton 1980:24–25)." Since this death was not reported in local newspapers, it is not known whether the second mate was really killed or not. Either way, the alleged "chest of gold" is surely either an island myth or a product of the fanciful imagination of Margaret Eaton, in whose diary the event was recorded. Even so, she mentions it again in her diary several years later. Frank Nidever, grandson of the famous Captain George Nidever, told Margaret and Ira a story of a diver who had supposedly been grabbed by an enormous, tentacled "devilfish" and nearly crushed to death. Nidever speculated that *J. M. Colman's* mate may have suffered the same fate as he dove after the lost gold (Eaton 1980:89). If nothing else, these amusing anecdotes show how quickly local myths grow up around exceptional events like shipwrecks.

The tug *Seawitch* returned to San Pedro on September 8 and reported it was unable to aid the stranded *J. M. Colman*. The wrecked schooner had settled inshore among treacherous rocks and reefs, reported the tug's captain, and waves were breaking a half mile further offshore *J. M. Colman*; they could not get within a mile of the grounded vessel. Regardless, the steamer *Marshfield*, owned by the same company as *J. M. Colman*, left San Pedro on September 8 to make a last-ditch effort to pull the schooner off (*Los Angeles Daily Times*, September 9, 1905:7; *San Francisco Call*, September 9, 1905:3; *San Francisco Chronicle*, September 10, 1905:31). Although this effort proved unsuccessful, the steamer did manage to salvage

at least 60,000 bf of *J. M. Colman's* lumber (Los Angeles Daily Times, September 21, 1905:8).

The Salvage of *J. M. Colman* continued for more than a year:

The Schooner *Ellen*, Captain Vasquez, left for San Miguel Island yesterday for a load of lumber from the abandoned lumber schooner *Coleman* [sic]. Captain Vasquez has been engaged in the salvage work for some months past, and has taken a large amount of lumber from the wrecked vessel, but the *Coleman* is breaking up fast and it is not thought he will be able to make many more trips (*Santa Barbara News Press*, November 7, 1906).

A later article noted that *Ellen* had recovered 50,000 bf of lumber and that 100,000 bf remained. The total amount of lumber salvaged from *J. M. Colman* is unknown.

Left to the sea's fury, *J. M. Colman* eventually broke up and its remains scattered. *Comet* wrecked five years later on another part of the island and photographs taken of both wreck sites at that time provide a clue about *J. M. Colman's* eventual break-up on Point Bennett. Shortly after *Comet's* wreck in Simonton Cove, San Miguel Island in August 1911, a series of photographs were taken of the dismantled vessel on the beach. The pictures are by an unknown photographer and several include an unknown woman. This same woman, wearing the same clothes, appears in two photographs taken in Northwest Cove, Point Bennett, San Miguel Island (Figures 3.7 and 3.8). The background terrain conclusively proves the location of the photos as Northwest Cove. Because the woman in the photographs is wearing the same clothes, it is probable that the *Comet* photographs and the Northwest Cove photographs were taken on the same trip,

probably on the same day. The photographs in Northwest Cove show the woman sitting on a huge pile of timbers, several of which have been made into a make-shift lean-to. Because it cannot be discerned whether the timbers are from a wrecked vessel or not, what is more important about the photos is what they do not show. They do not show any intact structure from a sailing vessel. Because the photographer took a series of photos of the wrecked *Comet*, it may be assumed that if there had been anything recognizable left of *J. M. Colman*, it would have appeared in at least one photograph. Therefore, it can be speculated that *J. M. Colman* was probably completely broken up by 1911.

Obviously, the preceding argument hinges on the assumption that *J. M. Colman* wrecked on Point Bennett. All newspaper accounts of the wreck agree the vessel grounded on San Miguel Island, but none give a precise location. Because the vessel's wreck report was not located, the only documented evidence for the wreck's location comes from the account of First Mate Frank Patterson in the *Los Angeles Daily Times*. Patterson's only description is a "rocky reef on the sothewesterly [sic] shore of San Miguel Island (*Los Angeles Daily Times*, September 7, 1905:9)." It is highly unlikely, given *J. M. Colman's* direction of travel, from the northwest, that the vessel sailed around the western point of the island (Point Bennett) and grounded on the southwest shore. This is especially true in light of Patterson's next comment: "After striking, the *Coleman* ground and pounded her way over the first reef, sinking down into deeper water between where she first struck and another reef farther inshore (*Los Angeles Daily Times*, September 7, 1905:9)." A modern chart of San Miguel Island shows an extensive offshore reef system off Point Bennett's northwest coast, with virtually none south of the point. Therefore, the most likely approach of *J. M. Colman* as it neared San



**Figure 3.7.** Driftwood camp at Point Bennett, San Miguel Island, ca. 1911. The lady in the photo appears later at the *Comet*, about three and one-half nautical miles along the coast to the northeast. Photo courtesy of the Santa Barbara Museum of Natural History.



**Figure 3.8.** An additional view of driftwood at Northwest Cove, Point Bennett, San Miguel Island. Photo courtesy of Santa Barbara Museum of Natural History.

Miguel Island was from the northwest, where it struck one of the offshore reefs and drifted into Point Bennett, probably Northwest Cove.

Although *J. M. Colman's* loss was almost certainly a disaster for its owners, it, like other lumber schooner wrecks among the islands, was a blessing to island residents. There are at least two reports of lumber from *J. M. Colman* being utilized for island structures. William G Waters, part owner of San Miguel Island, used burros to haul lumber from the wreck to the plateau above Cuyler Harbor where he constructed a ranch house in 1906 (Roberts 1991:77, 99). The second report is from the diary of Margaret Eaton. On a trip to Santa Cruz Island in 1908, Mrs. Eaton discussed a cabin in Willow Canyon on Santa Cruz Island that was supposedly constructed with lumber from *J. M. Colman* (Eaton 1980:38). Although it is hard to imagine lumber being hauled from San Miguel Island to Santa Cruz Island, it is easy to see that free lumber from the sea would be readily used by island residents who had no other source of inexpensive wood.

#### SCHOONER *DORA BLUHM*

The second of the three schooners lost in the Channel Islands was *Dora Bluhm*. The vessel's last port was Coos Bay, Oregon, where it was loaded with 350,000 bf of lumber at Smith's Mill (*Los Angeles Daily Times*, May 28, 1910:10). With its cargo destined for the Golden State Lumber Company of Los Angeles, *Dora Bluhm* left Coos Bay on May 19, 1910 (NA 1910:RG 36:Wreck Report 1383; *San Pedro Daily News*, May 27, 1910:1). Like the other two schooners, *Dora Bluhm* had made the trip frequently, and had been sailing past the Channel Islands for 27 years. On this particular trip, however, the weather got the best of both man and vessel. The master of *Dora Bluhm*, Captain Oscar Johnson, described the event:

We left Coos Bay for San Pedro seven days before the wreck and everything went along smoothly until Wednesday afternoon, when a heavy gale accompanied by thick weather was encountered. About seven o'clock I made out San Miguel Island and changed the vessel's course. The weather was very thick and about an hour later the schooner struck heavily on the southerly end of Santa Rosa Island. After she struck, the seas, which were running sky-high, swept completely over the deck of the ship and it was only with great difficulty and danger we succeeded in launching a boat. Although the bottom was comparatively flat where the schooner struck she immediately broke in two, and in less than an hour she was a total wreck. We got away from the schooner none too soon. At the time of the accident the vessel was on the proper course and I attribute the wreck to a strong northerly current which runs like a mill-race between San Miguel and Santa Rosa Islands. Evidently this current caused the schooner to drift northerly and piled her on the beach [*Los Angeles Daily Times*, May 28, 1910:10].

As *Dora Bluhm* swept toward the island, Captain Johnson ordered sails struck and both anchors dropped, but this could not save the schooner (*San Pedro Daily News*, May 27, 1910:1; NA 1910:RG 36:Wreck Report 1383). As they launched the ship's boat, seaman Alex Winter was washed out of the boat and narrowly escaped death by the quick actions of his shipmate, Jack Stevens, who caught him around the shoulders with a line. The crew then set out for the mainland in the small boat without food or water and rowed until late the following day (newspaper accounts variously report 16 to

more than 24 hours later) until picked up by Captain Alex Smith in the gasoline-powered vessel *Santa Rosa Island* (*Los Angeles Daily Times*, May 28, 1910:10).

By all accounts, *Dora Bluhm* broke up quickly after striking the island. Both vessel and cargo were uninsured and a total loss for the owners. *Dora Bluhm* was estimated to be worth \$5,000, while the lumber cargo was worth \$10,000 (NA 1910:RG 36:Wreck Report 1383). There are no reports of any attempt to salvage either the schooner or the cargo.

The precise wreck location is not mentioned in any accounts of the event, and is therefore unknown. The official wreck report filed by Captain Johnson with the United States Life-Saving Service in Los Angeles states only that *Dora Bluhm* was lost on the “south point of Santa Rosa Island (NA 1910:RG 36:Wreck Report 1383).” Both the *Los Angeles Daily Times* and the *San Francisco Chronicle* accounts report the vessel went ashore between the wrecks of the “*Golden Shore*” [*Goldenhorn*], lost in 1892, and the *Crown of England*, wrecked in 1896, both on the southern or southwestern shore of Santa Rosa Island (*Los Angeles Daily Times*, May 28, 1910:10; *San Francisco Chronicle*, May 28, 1910:1). This would place *Dora Bluhm* somewhere between Ford Point, location of the *Crown of England* wreck, and Sandy Point, nearly the western-most point of Santa Rosa Island. Although there is no documentary evidence, previous researchers have claimed *Dora Bluhm* wrecked on Bee Rock, just off the island’s southwestern coast (Howorth and Hudson 1985, quoted in Morris 1996). This claim is not, however, consistent with newspaper reports that universally report the vessel went ashore on the island. Survey of the area between Ford Point and Sandy Point reveal the only physical evidence of a wrecked,

ocean-going vessel on Cluster Point, Santa Rosa Island.

### SCHOONER *COMET*

The third schooner, *Comet*, was lost August 30, 1911. The vessel left Aberdeen, Washington, on August 23, loaded with approximately 500,000 bf of lumber bound for San Pedro. On Wednesday, August 30, at 8:00 p.m., while sailing in heavy seas with a thick fog, *Comet* struck what was reported as Richardson Rock, approximately 20 miles south of Point Conception and 7 miles north of San Miguel Island in the Santa Barbara Channel (NA 1911:RG 36:Wreck Report 221). It was later determined that the schooner actually hit Wilson Rock, which is 2½ miles northwest of the island and closer to the final resting place of *Comet* (*Santa Barbara Independent*, September 14, 1911; *Los Angeles Daily Times*, September 15, 1911:15). After the vessel struck the treacherous rock, it was pulled off by the current and began drifting south towards San Miguel Island. The *Comet’s* master, Captain Nicolas Borgenson, noted:

I thought when the *Comet* was freed from her first perilous position, that I would be able to bring her to Santa Barbara, but she filled rapidly and I soon found that she was badly stoved in. She became water logged and I knew the best I could do was to beach her on San Miguel. She is lying in a favorable position and unless the seas become heavy, we may be able to get her off. Her hull must be in bad shape. There was a hard wind as well as a heavy fog when she struck. The ship’s chronometer must have been faulty for



we were about ten miles off our course  
[*Santa Barbara Morning Press*,  
September 2, 1911:8].

It was later reported that *Comet's* chronometer was in San Francisco being repaired, and the vessel was using one on loan, which was not accurate and placed the schooner about eight to ten miles off course (*Santa Barbara Independent*, September 16, 1911).

Captain Borgenson “lowered the sails to ease the strain” and then grounded the schooner in Simonton Cove, San Miguel Island (NA 1911:RG 36:Wreck Report 221). He, his wife, several members of the crew, and the ship’s cat boarded a boat and set out for shore (*Santa Barbara Independent*, September 1, 1911:1; *Santa Barbara Morning Press*, September 2, 1911:8). They found the waves between them and the beach so great that they were forced to change course and head for Santa Rosa Island instead, where they remained all day Thursday, August 31 (*Santa Barbara Independent*, September 1, 1911:1). On the following morning Frank Pepper of the Santa Rosa Island Company took Borgenson, his wife, and the cat to Santa Barbara, where the first report of the wreck was made (*Santa Barbara Morning Press*, September 2, 1911:8). The rest of the crew returned to *Comet*.

On Friday, September 1, Borgenson set out for San Miguel Island to inspect the wreck. At that time, if he was not optimistic about the chances of saving *Comet*, he was at least hopeful about salvaging the cargo. Before he left Santa Barbara he remarked that he would examine the vessel to “decide whether she should be unloaded or whether she can be towed to port with the load on (*Santa Barbara Independent*, September 1, 1911:1).” He believed the schooner itself was “beyond repair (*Santa Barbara Morning Press*, September 2, 1911:8).”

When Borgenson arrived at the *Comet* that day, he was in for two unpleasant surprises.

First, the schooner’s second mate, Hans Maihbom, a 24-year-old German, had drowned when he attempted to swim to the wrecked vessel from the beach. Second, conditions at the wreck site were so severe that salvage was impossible. He reported at this time that the vessel was lying broadside to shore with the heavy seas pounding over its deck, and that its rigging had been entirely carried away. He thought the wreck would soon be dashed to pieces (*Santa Barbara Morning Press*, September 3, 1911:1).

On the morning of September 16, 1911, John A. Hooper, whose company owned *Comet*, arrived in Santa Barbara. He reported the vessel was likely to prove a total loss to him and the other owners, as neither vessel nor cargo was insured (*Santa Barbara Independent*, September 16, 1911). There is some discrepancy in the historical record over how much that loss would be. The *Santa Barbara Morning Press* reported the vessel was valued at \$12,000 and the cargo at \$13,000 (*Santa Barbara Morning Press*, September 2, 1911:8). The official wreck report filed by Captain Borgenson, however, noted that the schooner’s value was \$5,000 and the cargo \$3,000 (NA 1911:RG 36:Wreck Report 221). Because *Dora Bluhm's* 350,000 bf of lumber was valued at \$10,000, it is more likely that *Comet's* 500,000 bf was worth \$13,000 than \$3,000.

Because of *Comet's* exposed position and the high seas, which were breaking 200 to 300 yards outside the wreck, it was impossible to salvage the cargo from the ocean-side. Deckload lumber was reported scattered along the island’s shore for nearly a mile, but the cargo still within the vessel’s hold was virtually intact (*Los Angeles Daily Times*, September 15, 1911:15). This was no doubt a tempting prize for any salvager, considering the lumber cargo was worth more than the schooner even before it wrecked. The cargo’s value is probably what led Mr. Vickers, one of the owners of Santa Rosa

Island, to buy the wreck from Hooper, considering the questionable worth of the hull. It was reported that Vickers intended to use the salvaged lumber for improvements to his cattle operations on Santa Rosa, and hoped to earn some of his money back through the sale of *Comet's* donkey engine (*Santa Barbara Morning Press*, September 22, 1911:8).

At this point, the historical record becomes somewhat confusing. After the September 22 report of *Comet's* sale to Vickers, there is no further mention until October 16, 1911 when the *San Francisco Call* stated that salvage rights went to G. W. Waters, owner of San Miguel Island. Waters permitted no one to transport lumber to the beach for salvage, and, since salvage by sea was impossible, Waters purchased the rights to the wreck for an incredibly low \$1,000. According to the article, Waters and his partner expected to clear about \$10,000 in the venture, and had already made enough from the rigging alone to cover expenses (*San Francisco Call*, October 16, 1911:14).

There are two likely explanations for what transpired. The first is that when Vickers heard that Waters would not allow salvage from land, he may have backed out of the deal, and Hooper was forced to sell to Waters. This is the most plausible explanation. The other interpretation is that the *Call* article had its facts mistaken, and that the sale to Vickers went through; he was then forced to sell to Waters for \$1,000. Either way, there is no doubt that Waters, through his perspicacity, was the ultimate winner in *Comet's* salvage.

As discussed above, a series of photographs were taken of *Comet* sometime after the wreck and before the vessel broke up. These undated photos, from the Santa Barbara Museum of Natural History's collection, show the schooner lying broadside to the surf with its port side to sea (Figures 3.9–3.11). The vessel is firmly embedded in the sand, probably between the

mean high- and low-tide lines. The foremast is still standing, but the main- and mizzenmasts are gone. Two photographs, taken from just forward of the foremast looking forward, show a man and woman standing on *Comet's* bow (Figures 3.12 and 3.13). These photographs are the key evidence in identifying wreckage in Simonton Cove as *Comet*. In the background of the photographs is an easily identifiable rock formation that is east of the wreckage in Simonton Cove today (Figure 3.14). Therefore, with the help of these historical photographs, a positive identification of the *Comet* wreck site can be made.

## DISCUSSION

A discussion of general oceanographic conditions in the Santa Barbara Channel and specific conditions at the time of each wreck can help explain how and why each wreck happened. The prevailing winds in the Channel Islands blow from the west, southwest and northwest (Browne 1994:31; Coast Pilot 1903:10). Produced by offshore high pressure, these winds can often be violent. Fog is also a common threat in the Channel Islands and has caused the loss of many vessels. Thick fog can occur at any time, but is more frequent in July, August, and September; it can continue for weeks at a time (Coast Pilot 1903:11). During periods of low visibility, the Channel Islands themselves become the primary threat, while offshore rocks and shoals become even more dangerous than usual (Morris 1996). The variety of forces working in the Santa Barbara Channel creates a regionally complex oceanographic situation. Historically, seafaring captains would have to take into account the myriad currents working in concert among the Channel Islands when navigating by dead reckoning.

The primary navigation route along the California coast takes vessels either through the



**Figure 3.9.** *Comet* aground in Simonton Cove, San Miguel Island. Photo courtesy of Santa Barbara Museum of Natural History.



**Figure 3.10.** *Comet* aground in Simonton Cove, San Miguel Island, with unidentified woman. Photo courtesy of Santa Barbara Museum of Natural History.



**Figure 3.11.** *Comet's* stern, aground in Simonton Cove, San Miguel Island. Photo courtesy of Santa Barbara Museum of Natural History.



**Figure 3.12.** Unidentified woman on *Comet's* forecastle deck. Photo courtesy of Santa Barbara Museum of Natural History.



**Figure 3.13.** Unidentified man on *Comet's* forecastle deck. Note the capstan which is still mounted in the same location today. Also, note the rock ledge in the background which can be compared to Figure 3.14. Photo courtesy of Santa Barbara Museum of Natural History.



**Figure 3.14.** Anchor stock sticking out of the sand in Simonton Cove in the 1980s. Compare the rock ledge in the background to Figure 3.13. NPS photo by Don Morris.

Santa Barbara Channel, or just south of it, known as the outer Santa Barbara Passage (Coast Pilot 1903:31). Although it would seemingly be safer to avoid the islands altogether, the lure of a faster run made the Santa Barbara Channel and the outer Santa Barbara Passage the natural choices. As evidenced by the high concentration of wrecks in the Channel Islands, this may not have been the wise choice, though it was mandated by economic concerns. The United States Coast Pilot, published in 1903, gives detailed sailing directions for both routes. Because of the variety of currents active in the area, it recommends frequent sounding in thick fog or at night and it cautions against approaching the islands too closely. The Coast Pilot notes, "in thick weather, vessels should keep farther offshore . . . and if the weather is exceptionally heavy it is best to heave-to at a safe distance from shore until the weather moderates (Coast Pilot 1903:30).

All three vessels examined during this study, *J. M. Colman*, *Dora Bluhm* and *Comet*, were southbound from Puget Sound to Los Angeles when they were lost. An analysis of sailing directions from the United States Coast Pilot (1903) and the circumstances under which each vessel was lost gives a further understanding of the hazards of the Channel Islands region. For navigating the outer Santa Barbara Passage, from a point 12 miles southwest of the Point Arguello Lighthouse, just north of Point Conception, the Coast Pilot calls for a southeasterly course (S 28° 55' E true) for 40 miles. This brings the vessel to a point 8¼ miles southeast of Point Bennett, San Miguel Island and 12½ miles southwest of the west end of Santa Rosa Island. From this point a course correction is made to an east-southeast course (S 64° 50' W true), to Los Angeles or San Diego. This course takes the vessel extremely close to San Miguel Island, and very little pilot error is necessary for catastrophic results.

For example, from the point southwest of Point Arguello, a course error of less than five degrees leads the vessel into Northwest Cove, San Miguel Island. *J. M. Colman* had been navigating in a thick fog for almost 36 hours when it grounded in Northwest Cove, so a small error in navigation is not surprising. This wreck can probably be attributed to pilot error caused by thick weather.

According to Captain Oscar Johnson, *Dora Bluhm* was "on the proper course" when it struck Santa Rosa Island (*Los Angeles Daily Times*, May 28, 1910:10). If they were in the correct position for the course change just south of San Miguel Island, then it would take a large error of more than 27 degrees for the vessel to ground near Cluster Point. Johnson attributed the vessel's loss to an unusually strong northward flowing current between San Miguel and Santa Rosa Islands. Such a current is possible, as described above. It is therefore likely that a combination of a strong gale and a powerful inter-island tidal flow caused *Dora Bluhm* to ground on Santa Rosa Island.

Wilson Rock, 2½ miles north of San Miguel Island, is several miles off-course from either the Santa Barbara Channel sea-lanes or the outer Santa Barbara Passage. *Comet's* master, Nicolas Borgenson, attributed the navigation error to a faulty chronometer, which placed the vessel 10 miles off course. This is entirely plausible. If *Comet* had made the proper course correction southwest of Point Arguello and was heading for the outer Santa Barbara Passage, a 10-mile error would put the schooner in the vicinity of Wilson Rock. Other contributing factors were the thick fog and high winds the vessel was sailing in at the time of its loss.

Although a lighthouse at the western entrance to the channel had been advocated for years, it was not until 1909 that the Lighthouse Board recommended erection of a navigational

aid. Unfortunately, Congress did not appropriate money for the lighthouse until it was too late for the three Hall-built schooners (*Santa Barbara Morning Press*, September 2, 1911:8). In 1911, shortly after *Comet* wrecked, a lighted buoy was placed southwest of Point Bennett, San Miguel Island's western-most point. The following year a flashing acetylene beacon atop a 16-foot buoy was anchored near Richardson Rock, a hazardous shoal just north of San Miguel Island. A similar acetylene light was established in 1912 on Anacapa Island, at the eastern end of the Santa Barbara Channel. This preceded Anacapa Island's present lighthouse, which was constructed in the early 1930s (Roberts 1978:70–71). Although weather was a contributing factor in *Dora Bluhm*, *Comet* and *J. M. Colman*'s loss, all three wrecks could have been avoided had the vessel's captains heeded

the advice of the US Coast Pilot, and hauled well offshore when nearing the islands in inclement weather.

The fate of these schooners in the Channel Islands is not uncommon. Literally hundreds of vessels have grounded, foundered or wrecked in or around this string of navigational hazards off the California coast. What makes these particular wrecks unique is that all three were built by the Hall Brothers Shipyard within five years of each other; all three carried lumber on the same route for more than 20 years; and all three ended their careers under similar conditions in the same group of islands within six years of each other. This particular set of circumstances makes these three wrecks important to California's maritime history, and warrants a detailed archaeological examination of all three as a study collection.





## CHAPTER 4

### Archeological Analysis

---

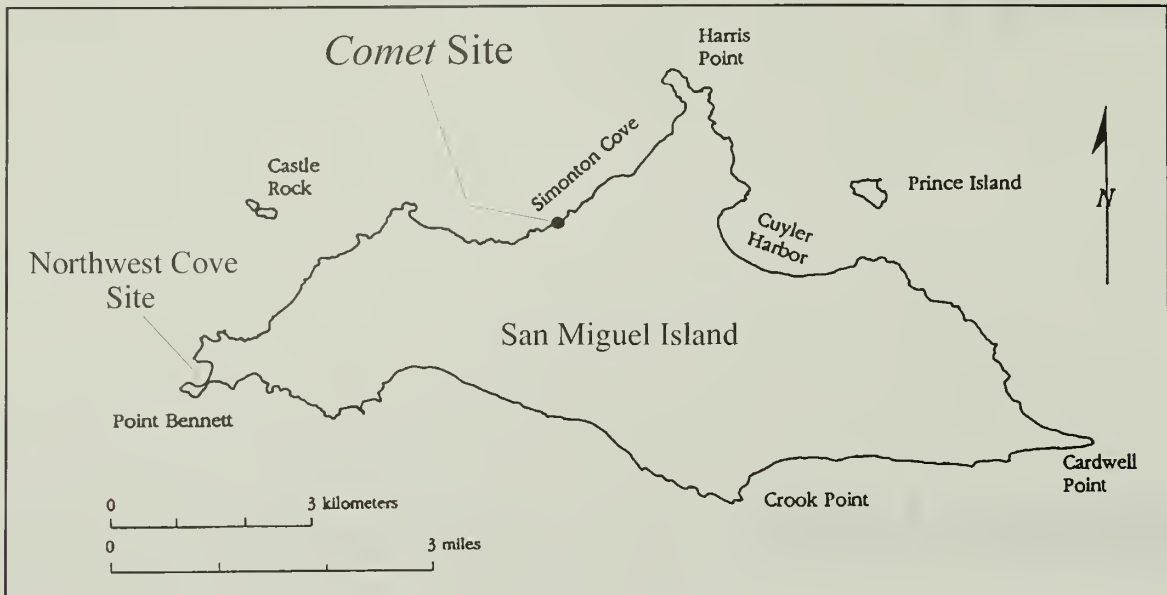
During fall 1993, archeologists documented and analyzed two beached shipwreck scatters in Channel Islands National Park (CHIS), California. The wreck scatters, located in Northwest Cove, Point Bennett on San Miguel Island and Cluster Point, Santa Rosa Island, may represent Pacific Coast lumber schooners *J. M. Colman* and *Dora Bluhm*, built by the Hall Brothers Shipyard of Puget Sound. A third site, the wreck of the Hall-built schooner *Comet*, which is normally completely buried under beach sand in San Miguel's Simonton Cove, was also investigated, but it was not until 1999 that winter storms uncovered these remains allowing archeologists to document this remarkably well-preserved shipwreck.

#### LOCATION

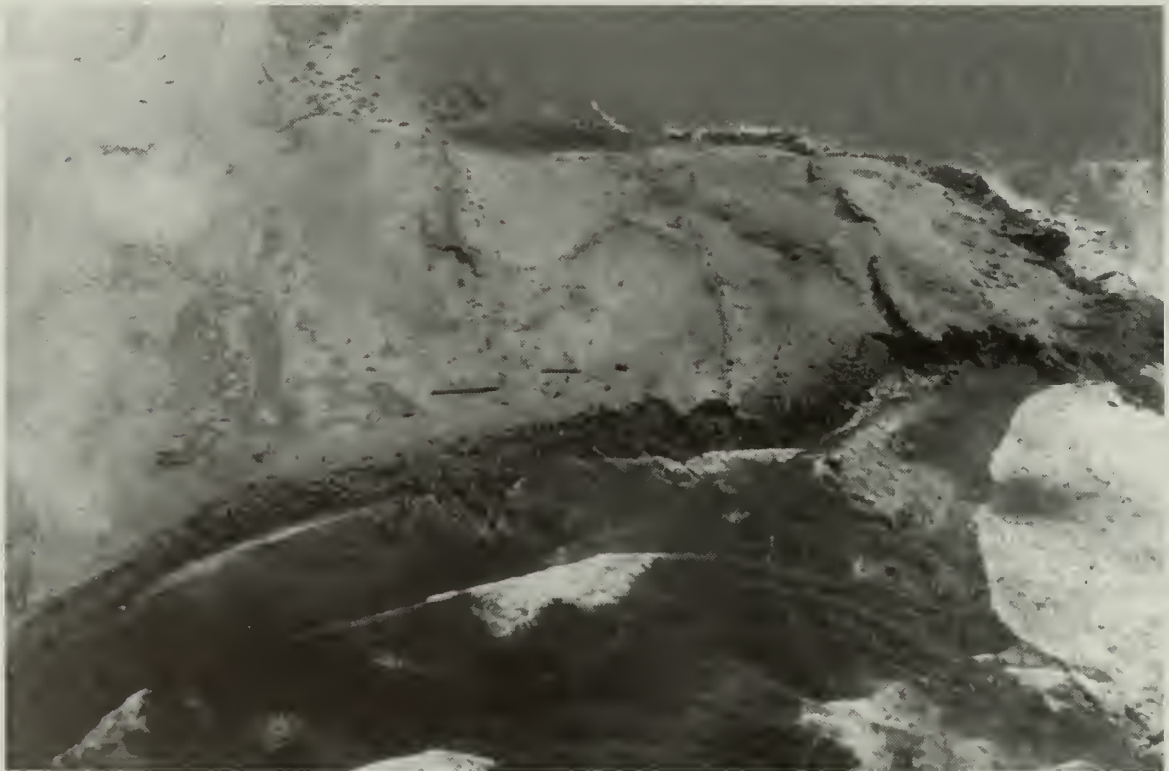
The three sites investigated are located in CHIS. The Northern Channel Islands: San Miguel, Santa Rosa, Santa Cruz and Anacapa, form the southern boundary of the 72-mile-long

Santa Barbara Channel (see Figure 1.1). Aligned in an east-west pattern, the islands roughly parallel the California mainland at this location on the coast. The Santa Barbara Channel's western entrance is flanked by Point Conception on the north and San Miguel Island, 26 miles from the mainland, on the south. The channel's eastern end is marked by Anacapa Island, 11 miles from shore.

The Northwest Cove site is located on the northwest side of Point Bennett, San Miguel Island (Figures 4.1 and 4.2). This site covers an area approximately 650 ft. x 360 ft., with two distinct scatters: one lying in the rocky intertidal zone offshore; the other located well above the high-tide line on a hard-packed sand beach. The *Comet* site is located in Simonton Cove on San Miguel Island's northern shore (Figures 4.1 and 4.3). The site's remains are highly compact and its proximity to the high-tide line changes with the depth of sand on the beach: in 1993, when *Comet* was completely buried, the site was about 40 ft. above the high-tide line; in 1999, the site



**Figure 4.1.** Comet site and Northwest Cove site locations on San Miguel Island.



**Figure 4.2.** Aerial view of Northwest Cove on San Miguel Island's Point Bennett. NPS photo by Matt Russell.

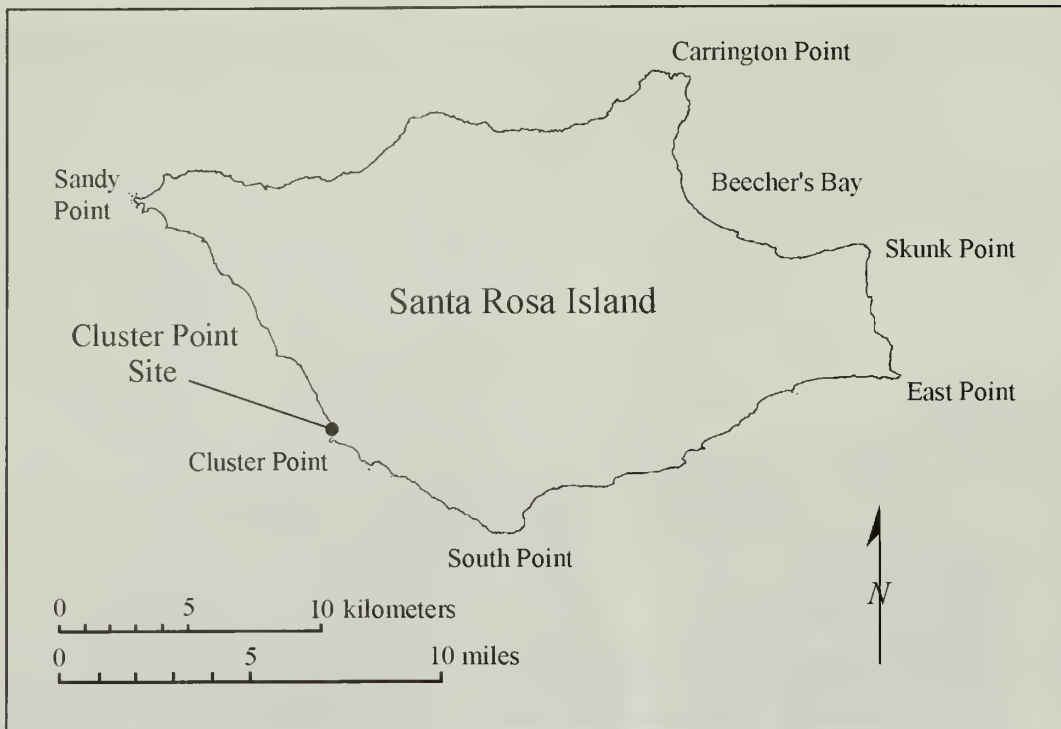


**Figure 4.3.** Aerial view of *Comet* site in Simonton Cove. *Comet* bow wreckage is on the beach in the center of the photograph. Photo courtesy of Robert Schwemmer.

was located between the high- and low-tide lines. The Cluster Point site is located on the southwest side of Santa Rosa Island, and covers an area approximately 575 ft. x 100 ft. located on a sandy beach among small dunes above the high-tide line (Figures 4.4 and 4.5).

The Northwest Cove and Cluster Point sites consist of scattered timbers and iron wreckage with no obvious association. Archeologists and resource managers often dismiss single elements like these as unimportant or useless, with a few notable exceptions (Delgado and Murphy 1984; Delgado 1985, 1986; Bright 1993; Agranat 1994; Amer, personal communication 1996). This study demonstrates that systematic analysis of disarticulated structural remains can reveal much about the identification of each hull component and likely associations. This project's 1993 goal was to document visible

remains at Northwest Cove and Cluster Point and test whether these wreck scatters represent *J. M. Colman* and *Dora Bluhm* as indicated in the historical record. In addition, this study examined site formation processes to determine whether they supported these associations. A second goal included examination of the *Comet* site to determine depth of sand overburden and feasibility of its removal. At that time, it became clear this site would have to be uncovered naturally before it could be fully documented, which occurred in 1999. From the beginning, this study followed the National Park Service's philosophy of minimum-impact archeology (Murphy and Russell 1997). In this approach only visible remains are recorded leaving the resources virtually undisturbed. The only impact to the sites was removal of a small wood sample from each timber for species identification.



**Figure 4.4.** Cluster Point site location on Santa Rosa Island.



**Figure 4.5.** Aerial view of Cluster Point, Santa Rosa Island. Photo courtesy of Robert Schwemmer.

## METHODOLOGY

Various terminologies have been proposed to describe beached shipwreck sites. Delgado and Murphy (1984) used the terms “buoyant hull,” “buoyant hull fracture” and “buoyant structure” to characterize different types of wreckage and the method by which they are deposited on the beach. Agranat (1994) uses the terms “transient shipwreck fragments,” which she defines as “parts of shipwrecks, ranging in size from single frame timbers to large sections of hull, which have broken off from shipwrecks on the ocean floor and wash up on shore. . . ;” and “eroded beach shipwreck remains,” which are “substantially articulated remains of ships which generally ran aground on the beach . . . and became buried in the sand.” Both of these nomenclatures focus on where the wreck occurred and how the shipwreck material arrived on the beach, rather than the vessel fragments themselves.

This study uses the terms *elements*, *fragments* and *hulls* to describe the various pieces of vessel fabric that make up beached shipwreck sites. These terms make no distinction between the location of the wreck event (i.e., offshore or on the beach) or how the wreck material was transported to the site; such considerations vary considerably between sites and even within individual sites. Instead, this terminology focuses on the objects themselves. An *element* is defined as a single, disconnected piece of vessel structure. A ship is made up of many disparate structural timbers or elements. A *fragment* is made up of multiple connected elements comprising a hull fragment. There is a wide range of variability in size and complexity within this category: it includes everything from two small timbers fastened together to an entire ship’s side. The final category, *hull*, is just that: an intact hull buried in the sand. Examples of this site-type include *King Philip* on Ocean

Beach in San Francisco and *Amsterdam* in Great Britain.

To determine whether the wreck scatters were associated with *J. M. Colman* and *Dora Bluhm*, material was examined in terms of specific variables and attributes. As defined by Watson, LeBlanc and Redman (1984:192), a variable is a “type of phenomenon being measured” and an attribute is a “particular state” of that variable. There are numerous attributes possible for every variable examined. While examining vessel elements and fragments during this study, four key variables were observed to help determine association with historical shipwrecks:

1. Element and fragment shape
2. Scantling size
3. Fastener type and size
4. Wood species

For each of these variables, several attributes were possible that could lead to an association with an historical shipwreck. For example, the attributes for element and fragment shape, scantling size, and fastener type and size had to conform to historically documented ship construction techniques and wood species had to be a species used in West Coast ship construction. For this study, because the three historical vessels being investigated were reportedly constructed entirely of Douglas fir, with the exception of the stempost and sternpost, which were probably white oak, the variable “wood species” had to have a specific attribute, “Douglas fir” or “white oak,” to be associated with one of the Hall-built schooners. Similarly, element and fragment shape, scantling size, and fastener type and size had to follow late-nineteenth century construction techniques. In addition, attributes for all four variables studied had to concur for an association with a shipwreck to be supported. For example, a

large, rectangular Douglas fir timber with no evidence of fasteners would be discounted because of lack of fasteners. Each variable was compared to the original construction contract of *Dora Bluhm* and *Comet* and to the *Rules for the Construction of Wooden Vessels*, published by the American Shipmaster's Association in the *Record of American and Foreign Shipping* (1879).

Marine underwriters used classification rules such as those published by the American Shipmaster's Association to determine insurance premiums and establish acceptable minimum standards for ship construction for insurance purposes. Vessels built in the United States generally followed classification rules stipulated by this Association. Standard rules were published annually in the *Record of American and Foreign Shipping* beginning in 1870 (Luckenbach 1943:1). By comparing timber and fastener size from a shipwreck site to scantling sizes provided in the *Rules for the Construction of Wooden Vessels*, minimum vessel tonnage can be generally determined.

The investigation was complicated by the fact that the archeological record at both Point Bennett and Cluster Point has been contaminated by intrusive material, which complicates determination of supportable associations. Because of local current conditions, the Channel Islands collect floating debris from both northern and southern California. The circulation patterns deposit debris along the island coasts from areas both north and south of the Channel Islands. Conversely, material removed from the islands can be redeposited in other locations within the islands, or anywhere north or south along the coast. Current patterns and flotsam depositional patterns are easily observed along the island's beaches. This phenomenon is graphically portrayed by an example noted in the *Santa Barbara Morning Press*, November 3, 1906:

Heavy west-nor'west gales have been blowing in the channel near the islands for several days past, and Captain Robards states that he had to lie under the east end of Santa Cruz for several days for safety. Captain Robards says that the wreckage of the *Shasta*, which went to pieces near Point Conception several weeks ago, is still in evidence, the greater part of the pilot house of the ill-fated schooner being now stranded on Bee Rock on the south side of Santa Rosa Island (offshore from Cluster Point) [*Santa Barbara Morning Press*, November 3, 1906].

This example clearly indicates that intrusive materials likely contaminate wreck scatters at both Cluster Point and Point Bennett, which complicates derivation of alleged associations.

#### DESCRIPTION OF FIELDWORK

Project personnel conducted field investigations from October 12–18, 1993, at Northwest Cove, Point Bennett, San Miguel Island (possible *J. M. Colman* site); October 19–23, 1993 and April 18–23, 1999, at Simonton Cove, San Miguel Island (*Comet* site); and November 2–7, 1993, at Cluster Point, Santa Rosa Island (possible *Dora Bluhm* site). We chose October for 1993, fieldwork because of restrictions enforced on Point Bennett from December through September for protection of breeding seals, sea lions and elephant seals. The week chosen for the Northwest Cove fieldwork was scheduled around a series of extremely low tides, which were necessary to record material in the littoral and intertidal zone. A representative of the National Marine Fisheries Service accompanied project personnel to Point Bennett to ensure minimal pinniped disturbance.

Team members placed a site datum on October 14, 1993, in Northwest Cove, Point Bennett by establishing horizontal control from a National Geodetic Survey (NGS) monument. We used a theodolite with an electronic distance meter (EDM) set up on the NGS brass cap to position the site datum. The datum is in a central location within the wreck scatter and was used for horizontal control.

The Northwest Cove site (possible *J. M. Colman*) consists of two distinct components: ferrous metal objects lying in the intertidal zone; and a variety of wooden wreckage located in the supralittoral zone above the high-tide line. Presence of iron material is clearly the result of a wreck event, most likely from a single vessel, based on the close proximity and similarity of the objects. The objects represent ground tackle and other machinery that would have been located in the bow and further aft towards midships, so it is unlikely they were rafted there from a shipwreck in another location. The hundreds of wooden pieces on the beach, on the other hand, present a very different case. The majority of wooden “wreckage” was not related to a shipwreck of any kind. A wide variety of wood is present, from logs 60 ft. long and 4 ft. in diameter to modern lumber and miscellaneous bits of driftwood. Of pieces that could be identified as ship-related, most were from modern, lightly constructed wooden boats. The first hypothesis, that all material was related to shipwreck events, was rejected. Methodology was refined to determine what material was associated with a shipwreck the size and age of *J. M. Colman*. The second and third hypotheses addressed the collection of material determined to be wreck remains, rather than the collection of material as a whole. The question was whether the assemblage was from a single vessel, and, if so, if the remains could be from *J. M. Colman*. This same revision would later be applied to the Cluster Point site (possible *Dora Bluhm*) on Santa Rosa Island.

The team conducted a comprehensive walking survey of the cove identifying timbers that might have come from a large, late-nineteenth century, ocean-going vessel. This was a qualitative rather than a quantitative process. Main characteristics considered were timber size and fastener evidence. Although there were many large timbers in the area, some of them did not contain any fasteners or fastener holes and were eliminated from further consideration. In addition, several pieces that exhibited modern nuts and bolts or other modern characteristics were also eliminated. Only timbers with fasteners or fastener evidence consistent with late-nineteenth century ship construction were included. This process of elimination narrowed the number of timbers studied to 15. All were labeled with temporary plastic tags numbered PB-001 through PB-015.

Project personnel conducted a comprehensive walking survey of the entire intertidal zone. The exceptional low tide of October 14 provided access to much of this area, and the survey yielded a total of 19 pieces of iron material. Every observed object was examined.

On October 15, 1993, we set the theodolite over the site datum and turned angles to each wood and iron feature. On timbers and larger iron objects both ends were surveyed to provide orientation. The EDM provided accurate distances, so the position of all material was precisely recorded relative to the primary site datum. Over the next two days, the crew made measured drawings and photographed each feature, in addition to collecting a wood sample from each timber. Project personnel recorded material in Northwest Cove, Point Bennett over a four-day period.

On October 18, 1993, field operations moved from the west end of San Miguel Island to the east end closer to the *Comet* site. Unlike the wreck scatters at Northwest Cove and Cluster Point, the wreck located in Simonton

Cove, San Miguel Island was positively identified as *Comet* using historical photographs (see Chapter 3). This wreckage was almost totally uncovered by winter storms in 1984 when a CHIS ranger took several photographs showing extensive vessel structure and a large anchor (see Chapter 1). At the beginning of 1993 fieldwork, the tip of the anchor stock was the only visible feature protruding above the surface of the beach. Because the wreck had been exposed in the past, we could remove sand overburden without destroying undisturbed stratigraphy. In addition, we conducted a terrestrial magnetometer survey over the site to test for the possibility of more extensive remains than appear in the 1984 photographs.

Four volunteers arrived on October 19, 1993, and work began that afternoon. The tip of the anchor stock was used as a starting point for sand overburden removal. Project personnel and volunteers spent October 20–21, 1993, excavating (Figure 4.6). The anchor was

uncovered, along with a few timber ends, and nothing more. Although the timbers located are certainly from *Comet*, no details could be recorded because the unstable walls of the hole kept collapsing as the timbers were exposed. In total, about 21 cu. yds. of sand were removed from a hole 21 ft. in diameter at the top and 7 ft. deep. The few remains uncovered indicated this site could not be exposed without mechanical excavation and shoring. Barring landing a backhoe, *Comet* would have to wait for detailed recording until naturally uncovered.

To test for additional remains, we conducted a terrestrial magnetometer survey over a 20-m x 40-m area, centered on the anchor. We used a Geometrics model G-856 terrestrial magnetometer and a 2-m sample interval. With the exception of two points where the test hole was located, a reading was taken at each 2-m interval resulting in a data set of 227 points. A base station was not available, so these readings were not corrected for diurnal variations, which



**Figure 4.6.** Volunteers working to expose *Comet* wreckage in October 1993. Just the tip of the anchor stock was exposed before digging began. NPS photo by Matt Russell.



reduce solar and local magnetic noise fluctuations. This data set can be viewed as a general magnetic representation of the site and unlikely to miss ferrous masses associated with ship structure.

The project moved to Santa Rosa Island on November 2, 1993, and work began at Cluster Point the following day. The same methodology employed at the Northwest Cove site at Point Bennett, San Miguel Island was used on the Cluster Point site. Horizontal control was brought to the site from an NGS monument, and a site datum established at a location central to the Cluster Point material. A comprehensive walking survey was completed, with timbers and wreckage tagged for positioning and closer examination. Once again, we included any possible shipwreck element or fragment in the study, with association to be determined later. The primary difference between the Cluster Point site and the Northwest Cove site is that no material was observed offshore, and no iron material was located on the beach.

The walking survey yielded 22 timbers and planks probably from a late-nineteenth century vessel. Although 24 timbers were originally tagged (CP-001 through CP-024), two were later eliminated as modern (CP-011 and CP-016). In addition, we recorded 15 loose iron fasteners of various sizes.

The next four days followed the same procedures as the Point Bennett survey. Positions of all material, including fasteners, were recorded with the theodolite and EDM. Each piece was drawn to scale, photographed and sampled for wood identification for determination of association with *Dora Bluhm*.

After several years of waiting, strong winter storms finally removed the sand overburden from *Comet* in early 1999. Five days were spent during the full documentation phase of the *Comet* project in April 1999. Researchers defined several goals for the project, including:

- 1) a detailed description of site nature, extent and preservation;
- 2) producing a site map for use in interpretation and monitoring future exposures;
- 3) detailed measured drawings of all vessel elements and features;
- 4) complete photographic and video documentation; and
- 5) collecting samples for analysis, especially wood species identification.

We scheduled fieldwork to take advantage of a series of negative tides from April 18–23, 1999. Although *Comet*'s remains were more exposed than they were in 1984, each day during the recording process, the remains were excavated to the water table with shovels so they could be drawn, photographed and videotaped. Because the site is relatively small, the methodology for site mapping was to establish a central datum and use a Brunton Pocket Transit mounted on a tripod to turn angles to each feature and a tape to measure distance. Nearly 100 points were mapped across the hull remains, and direct measurements and scale drawings were used to map the structure around these points (Figure 4.7). All site features, such as the capstan, windlass, outer hull planks and fore-castle-deck planking were drawn to scale, and the entire site was documented with video and photographs. In addition, four wood samples, five fasteners and one caulking sample were collected for analysis.

### NORTHWEST COVE SITE

The Northwest Cove site at Point Bennett, San Miguel Island, consists of two distinct components: iron material in the intertidal zone and wooden elements and fragments above the high-tide line. With the exception of a single, small piece of wood permanently concreted to the intertidal zone by iron fittings and a single unidentified iron object on the beach, these two site components are totally discrete. All iron objects are firmly fixed to the rock bottom of



**Figure 4.7.** Archeologists mapping *Comet's* bow section. NPS photo by Don Morris.

this high-energy zone and are permanent, unmoving features. The wooden material, on the other hand, even though above the high-tide line, is subject to shifting and movement from storm activity.

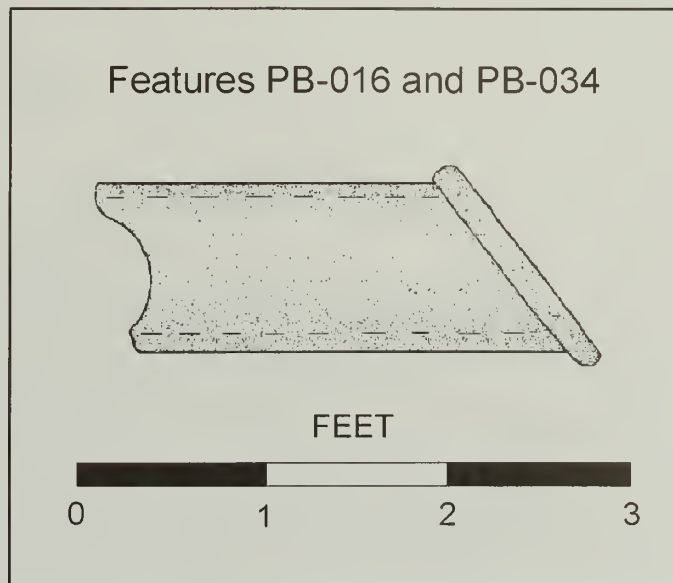
#### INTERTIDAL ZONE IRON FEATURES

Fundamental differences between the two site components include the observation that all intertidal zone iron material is definitely from a shipwreck and likely represents a single wreck event. Unlike the collection of wooden elements and fragments, which are mobile, there is no doubt as to how the iron material arrived in Northwest Cove. Because the objects are clearly shipboard items, and it is physically impossible that they floated to this location, the only logical conclusion is that this deposition occurred as a result of a stranded vessel. Although it might be possible for individual elements to be rafted

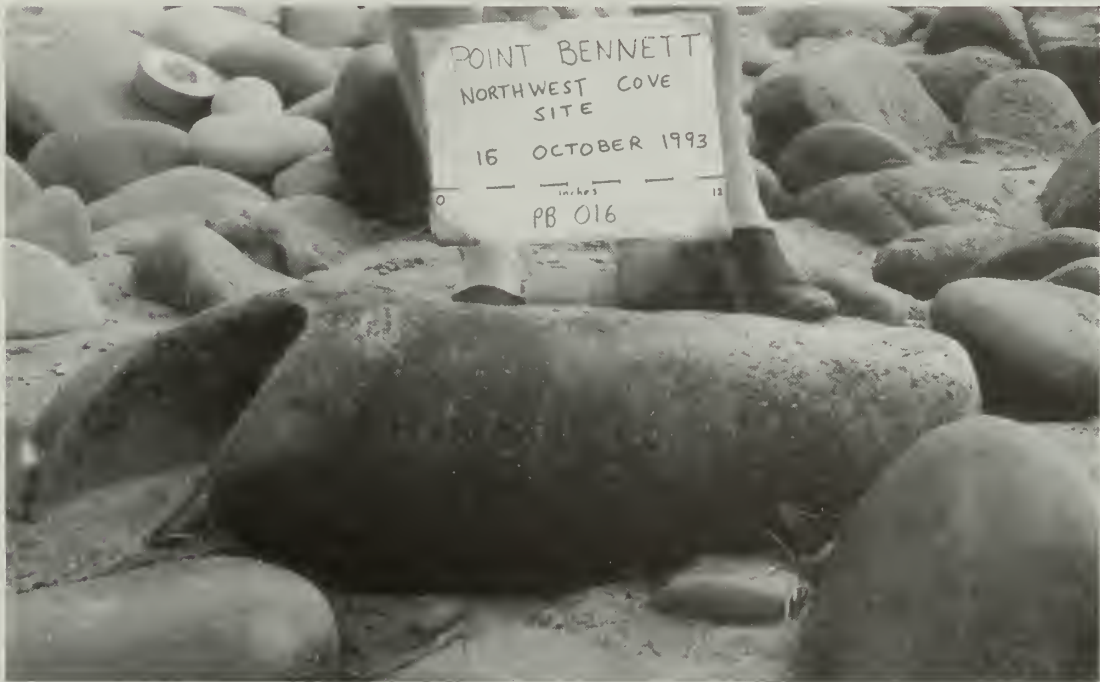
to this location on wooden fragments, it is unlikely that the entire collection was rafted here and deposited together.

The next task was to determine whether this material is from a late-nineteenth century sailing vessel, and more specifically *J. M. Colman*, based on object attributes. During fieldwork, the 19 intertidal zone iron objects were labeled PB-016 through PB-034 and will be referred to by these feature numbers during this discussion.

The most diagnostic objects in the intertidal zone are two hawse pipes, features PB-016 and PB-034, of identical dimensions (Figures 4.8 and 4.9). Hawse pipes were located on each side of a vessel's bow and allowed the chain cable to pass through the hull. Hawse pipes are distinguishable from mooring pipes (which allowed mooring lines to pass through the main deck bulwarks on the main deck) and chain pipes (which allowed the chain cable to pass through the main deck into the chain locker) by their



**Figure 4.8.** Features PB-016 and PB-034 are two identical hawse pipes. Drawing by Matt Russell.



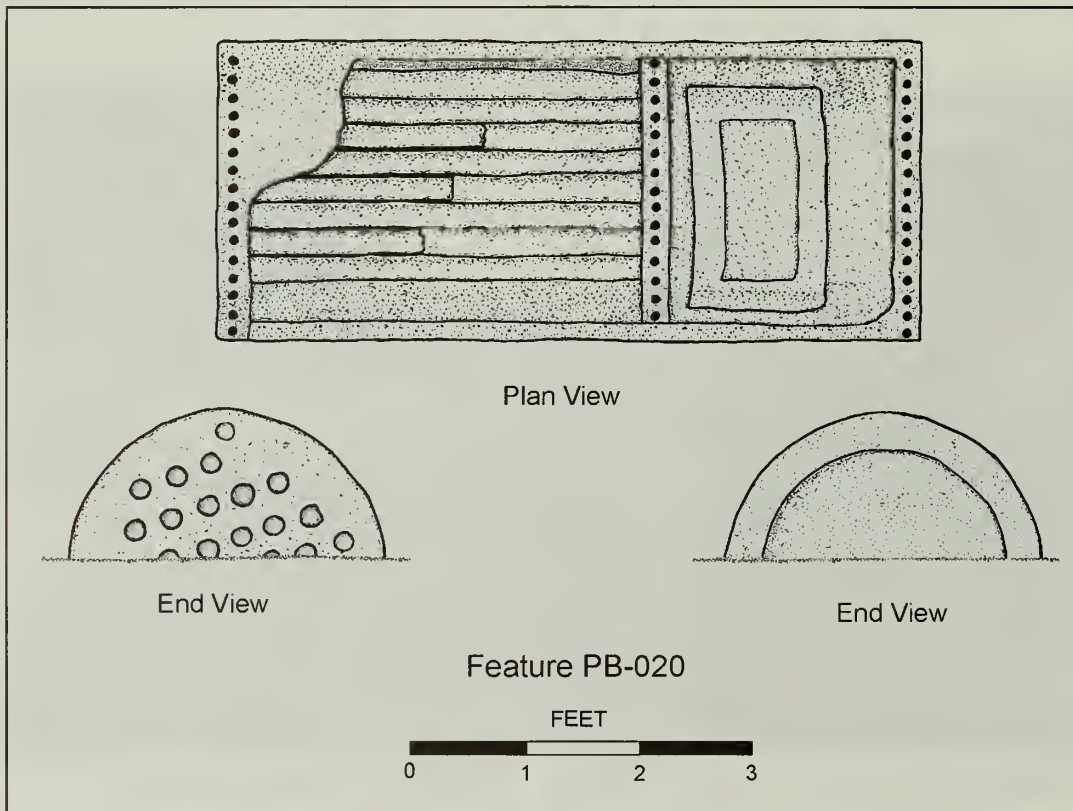
**Figure 4.9.** Hawse pipe (feature PB-016). NPS photo by Adriane Neidinger.

length and their sloping outer faces, which must conform to a bow's compound curves. PB-034 is located 50 ft. 6 in. northwest of PB-016. The two hawse pipes have the same dimensions, which, combined with proximity, indicate they came from the same vessel. The pipes have an overall length of 2 ft. 11 in., an outside diameter of 11 in. and an inside diameter of 9 in.

What makes these items particularly diagnostic is that classification rules specified hawse pipe size for a vessel based on anchor chain cable size; the size of chain cable was specified for vessels based on registered tonnage (chain was measured by the diameter of the link). *J. M. Colman* had a registered tonnage of 463 gross tons and 389 net tons. Desmond (1919[1984]) includes tables showing specifications for chain cable size based on

tonnage, and showing hawse pipe size based on chain cable size. A wooden sailing vessel of 400 tons was required to carry a chain cable at least 1 5/16 in. in diameter, which required a hawse pipe between 11½ and 12½ in. in diameter (Desmond 1919[1984]:157, 166). Although Desmond does not specify whether hawse pipe diameter is the inside or outside dimension, it is likely the inside dimension. The size of the hawse pipe does not entirely agree with the published historical data in this case. The reason for this is unknown, although the fact that this may not be *J. M. Colman* is a possibility. The preponderance of other evidence below makes this unlikely.

Feature PB-020 is another readily identifiable object, a steam donkey engine boiler (Figures 4.10–4.12). It is a cylinder



**Figure 4.10.** Donkey boiler (feature PB-020). Drawing by Matt Russell.



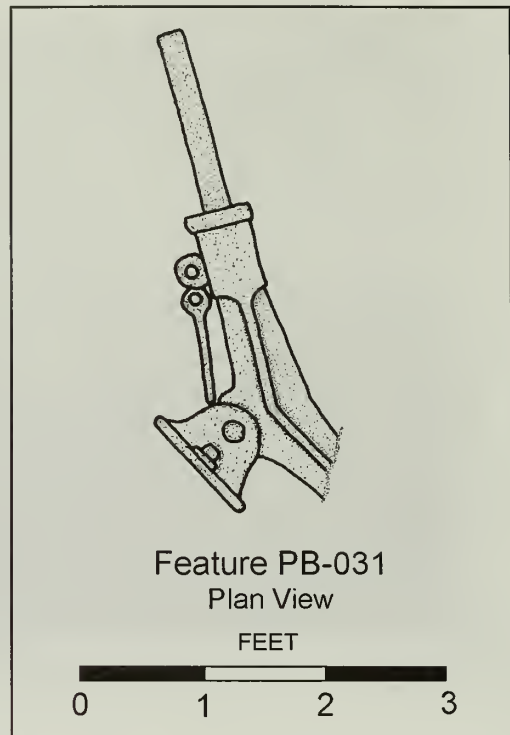
**Figure 4.11.** Donkey boiler (feature PB-020). NPS photo by Adriane Neidinger.



**Figure 4.12.** End view of the donkey boiler. NPS photo by Adriane Neidinger.

approximately 6 ft. 6 in. long and 3 ft. in diameter, its interior filled with 2¾-in. diameter tubes for about two-thirds of its length. Donkey engines, or “steam donkeys” as they were known, were found aboard coastal lumber schooners after the early 1880s (Cox 1974:231) and were used for a variety of purposes, including loading and unloading cargo, hoisting the sails and running the ship’s pumps. The donkey engine was usually located in the forward deckhouse, as in the coastal lumber schooner *C. A. Thayer*, built in 1895 by Hans D. Bendixsen and now on display at San Francisco Maritime National Historical Park. Like *J. M. Colman*, *Comet* and *Dora Bluhm*, *C. A. Thayer* is a three-masted lumber schooner and very similar in size and configuration to the Hall-built schooners.

Another intertidal-zone object identified is PB-031, which is the crosshead mechanism of a hand-operated, pump-brake windlass (Figures 4.13 and 4.14). An example of this mechanism can also be seen on board *C. A. Thayer*, where it is mounted on the forecastle deck, directly forward the sampson post above the windlass. The crosshead was attached to the windlass by connecting rods that passed through the forecastle deck and were connected to the windlass purchase rims (de Kerchove 1961:614). Removable handles were inserted into the crosshead and the up-and-down motion supplied by two seamen rotated the purchase rims, which turned the windlass. This is the same type of windlass and mechanism recorded on *Comet* (see below). Feature PB-031 is partially obscured by encrustation and marine growth, but a portion of one of the removable handles is present. The overall length of the piece is 4 ft. The base of the crosshead mechanism was secured to the forecastle deck with two 1-in. diameter iron fasteners. The base is about 10 in. square and 6½ in. tall, which is similar to the crosshead mechanism found on *C. A. Thayer*.

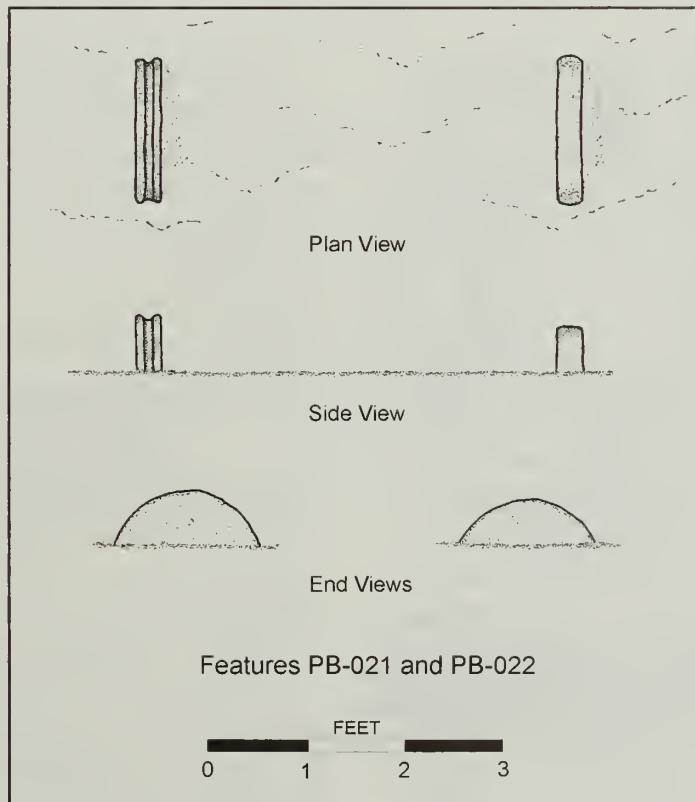


**Figure 4.13.** Crosshead mechanism from a pump-brake windlass (feature PB-031). Drawing by Matt Russell.

At least seven of the remaining intertidal zone features are either from a windlass, a donkey engine, or a messenger chain system that linked the two. A messenger chain used a series of chains, gears and shafts to connect a steam donkey engine to the windlass, pumps, auxiliary warping heads and other hoisting gear. *Comet* was equipped with a messenger chain system to drive its windlass (see below). Feature PB-021/022 (actually a single object) is likely part of a donkey engine (Figures 4.15 and 4.16). PB-021/022 are two circular iron pieces sticking upright out of the bottom, 4 ft. apart, and connected by a shaft that could not be exposed (which is why they were given separate feature numbers). The circular iron pieces are 1 ft. 6 in. in diameter. One of them (PB-021) is featureless, while the other (PB-022) is grooved



**Figure 4.14.** Crosshead mechanism from a pump-brake windlass. See Figure 4.96 for a similar mechanism. NPS photo by Adriane Neidinger.



**Figure 4.15.** Part of the drive mechanism from a donkey engine (features PB-021 and PB-022). Drawing by Matt Russell.



**Figure 4.16.** The two upright circular features are connected by a buried drive shaft.  
NPS photo by Adriane Neidinger.

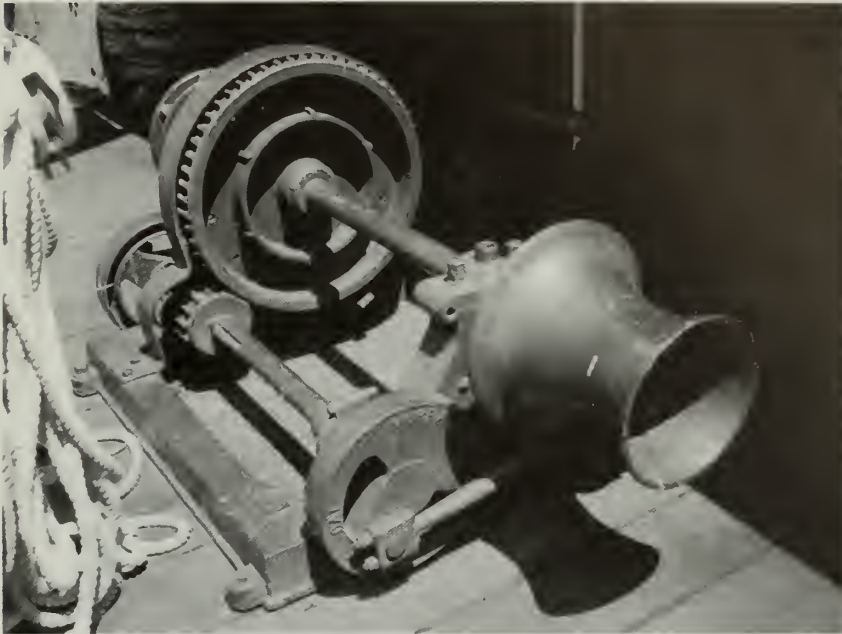
along the edge. Although positive identification is difficult, this feature is probably the drive spindle of a steam donkey engine (Figure 4.17).

Features PB-017, 018 and 023 are all similar objects and part of a vessel's windlass or messenger chain system. PB-017 is an iron ring with an outside diameter of 4 ft. 4 in., an inside diameter of 2 ft. 1 in., with a thickness of the main part of the ring 5 in. An inner flange adds 2 in. in thickness to either side (Figures 4.18 and 4.19). PB-018, also an iron ring, has an outside diameter of 3 ft., an inside diameter of 2 ft. 2 in., and is 4 in. thick (Figures 4.20 and 4.21). PB-023 is a solid circular iron object 2 ft. 1½ in. in diameter and 4 in. thick (Figure 4.22). All three features have edges notched for gears. Edges of PB-018 and PB-023 have closely spaced gears, while the edge of PB-017 has teeth spaced about every 7 in. Feature PB-018 is likely the purchase rim of a windlass (Figure 4.23). The 7-in.-spaced teeth of PB-017 are from the messenger chain system that ran this machinery.

Features PB-026, 027 and 029 are also likely parts to either a windlass or a donkey engine. Both PB-027 and PB-029 contain warping hubs and geared mechanisms on shafts, likely parts from the windlass, a deck winch or the donkey engine (Figures 4.24–4.27). PB-027 is 3 ft. 9 in. long, and PB-029 is 2 ft. long. The warping hubs on each are identical, 1 ft. 4 in. long and 1 ft. in diameter at their narrowest point. Feature PB-026 has a large, circular geared mechanism 1 ft. 10 in. in diameter, and a smaller circular object 1 ft. 5 in. in diameter (Figures 4.28 and 4.29). The teeth on the latter's edge are spaced on 7-in. centers, same as PB-017, which is also from the messenger chain system (Figure 4.30).

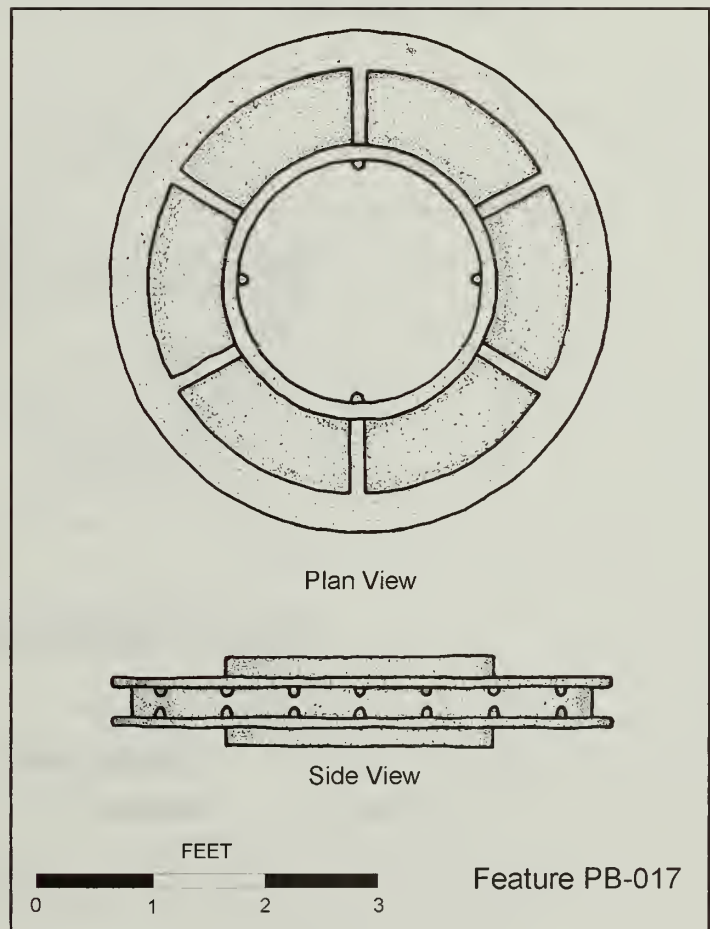
PB-025 is a large, rectangular-shaped iron feature encrusted to the seabed. It has an outside length of 7 ft. 2 in. and an outside width of 4 ft. 1 in. The inside length is 6 ft. 4 in., while the inside width is 3 ft. 1 in. The object is 8 in. high (Figures 4.31 and 4.32). At first glance, the object appears to be some sort of hatch coaming, which is unlikely because cargo hatches on





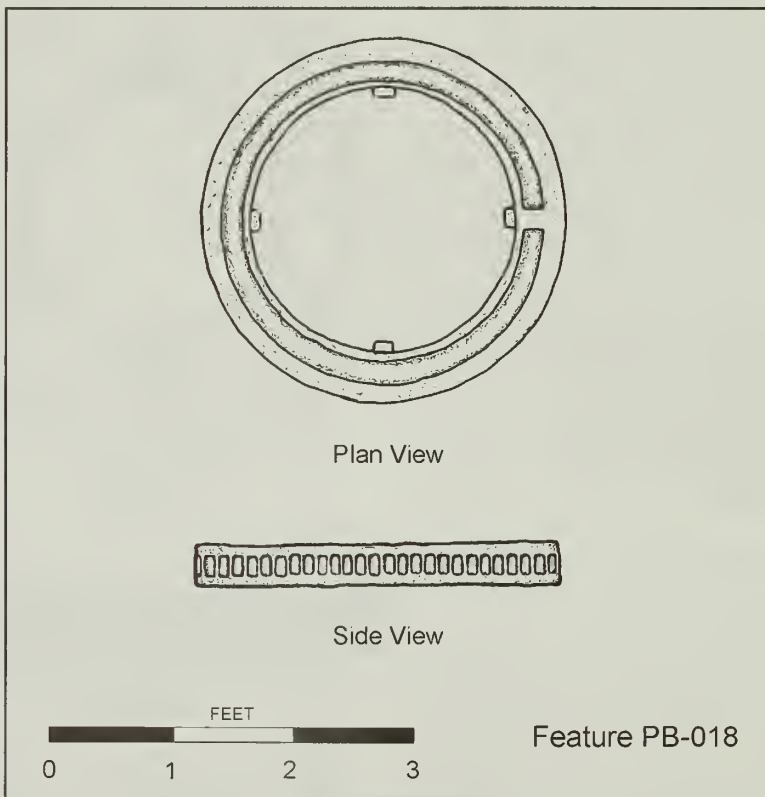
**Figure 4.17.** Windlass from *Falls of Clyde* in Honolulu, Hawaii. The smaller mechanism to the left is similar to features PB-021 and PB-022. NPS photo by Matt Russell.

**Figure 4.18.** The widely-spaced teeth on this feature's outer edge indicate it is part of a messenger chain system that ran the windlass from a donkey engine. Drawing by Matt Russell.





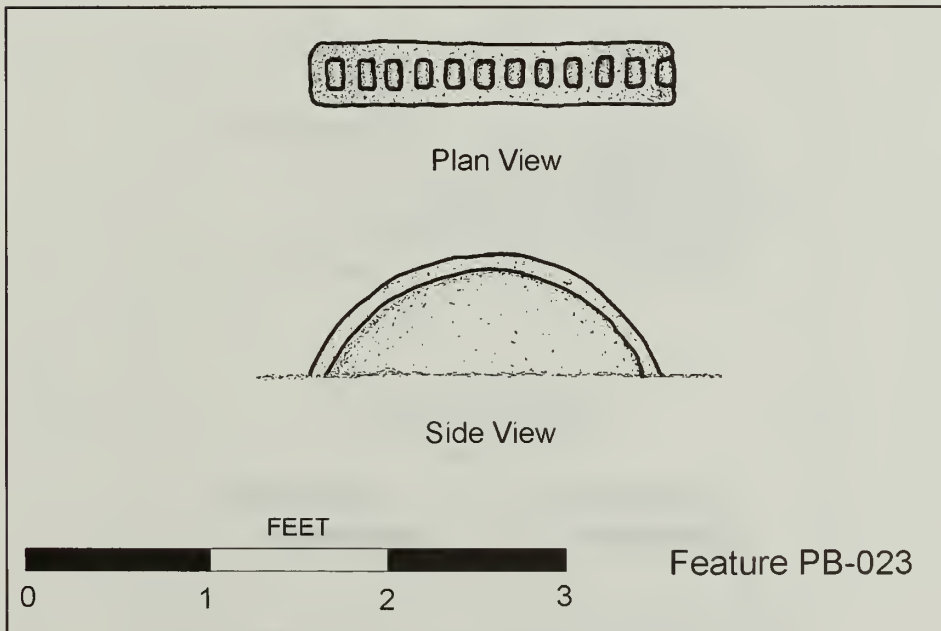
**Figure 4.19.** Iron ring from a windlass messenger chain system (feature PB-017). NPS photo by Adriane Neidinger.



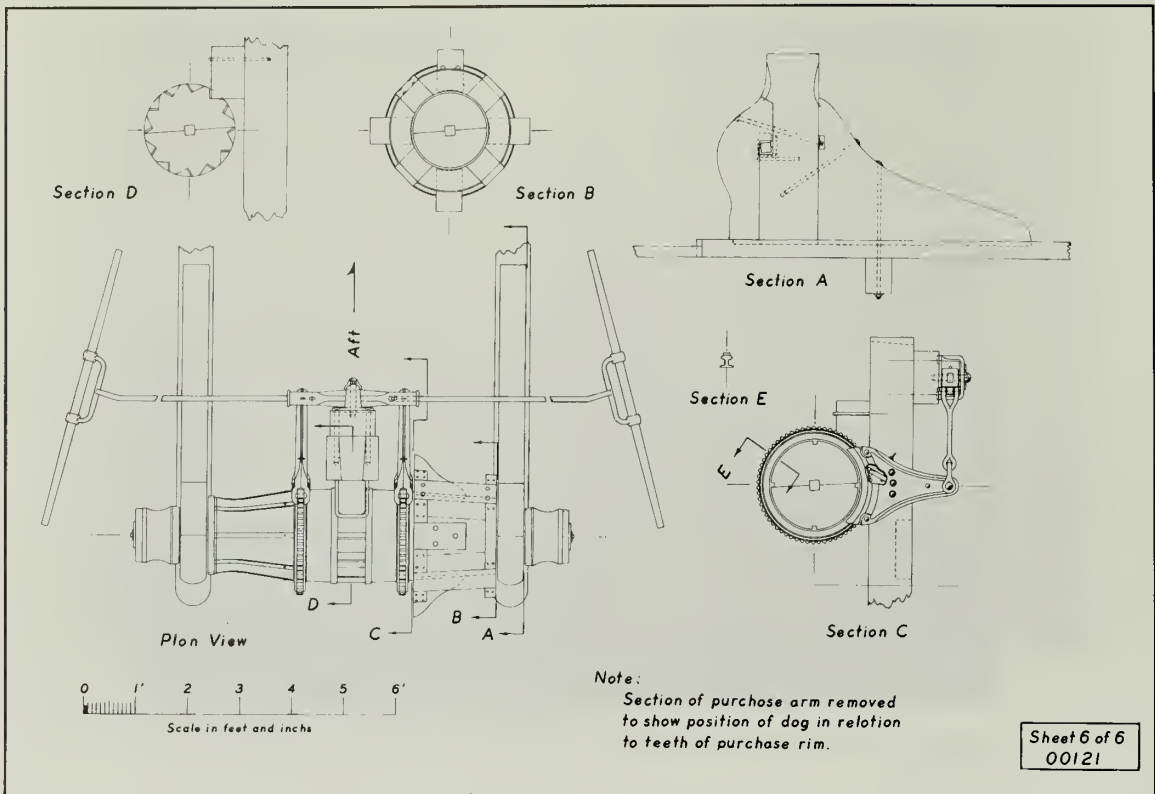
**Figure 4.20.** Purchase rim from a pump-brake windlass. Drawing by Matt Russell.



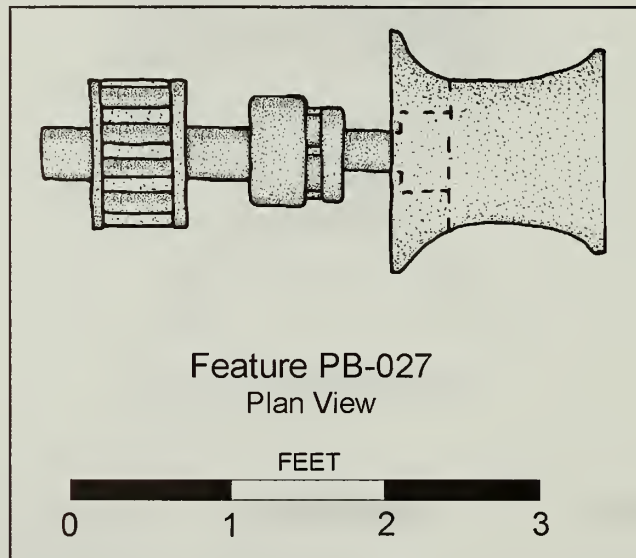
**Figure 4.21.** Purchase rim (feature PB-018). NPS photo by Adriane Neidinger.



**Figure 4.22.** Unidentified windlass element (feature PB-023). Drawing by Matt Russell.



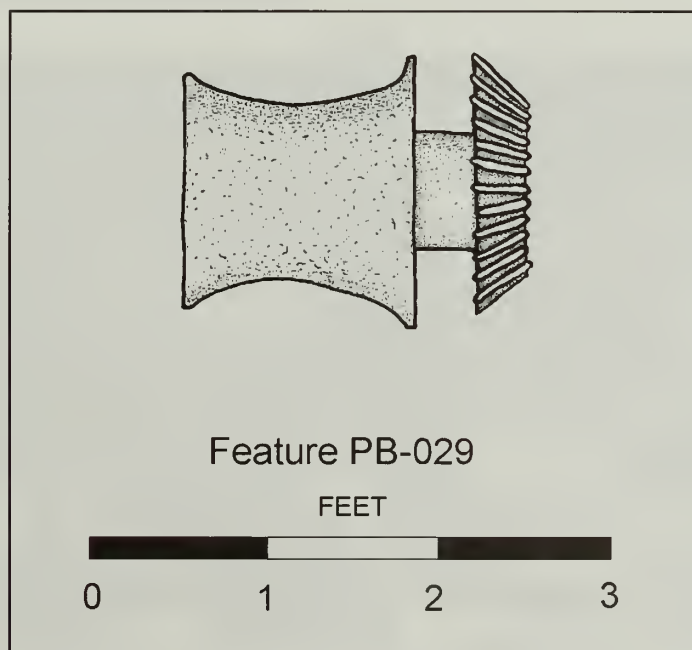
**Figure 4.23.** Feature PB-018 is a purchase rim, pictured here in Section C with the purchase arm attached. Note the four teeth on the inside of the rim that match those on feature PB-018. Drawing from the Smithsonian Institution.



**Figure 4.24.** Unidentified windlass element with the warping hub (feature PB-027). Drawing by Matt Russell.



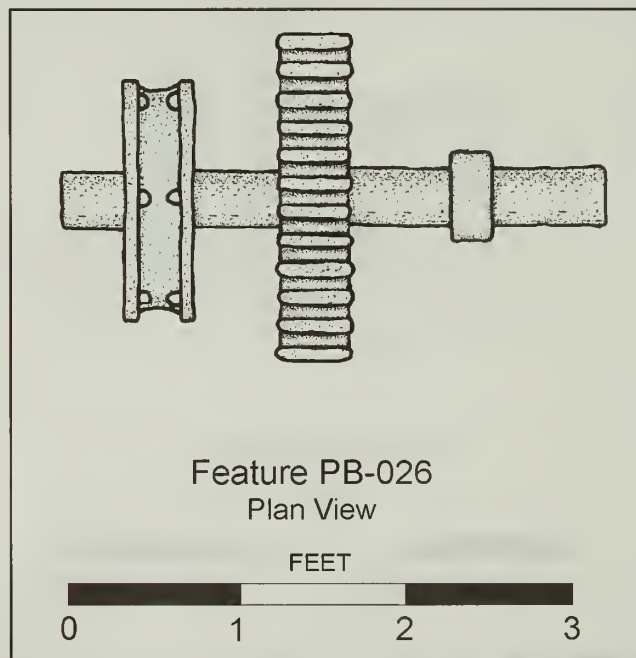
**Figure 4.25.** Feature PB-027. NPS photo by Adriane Neidinger.



**Figure 4.26.** Another unidentified windlass element (feature PB-029). Drawing by Matt Russell.



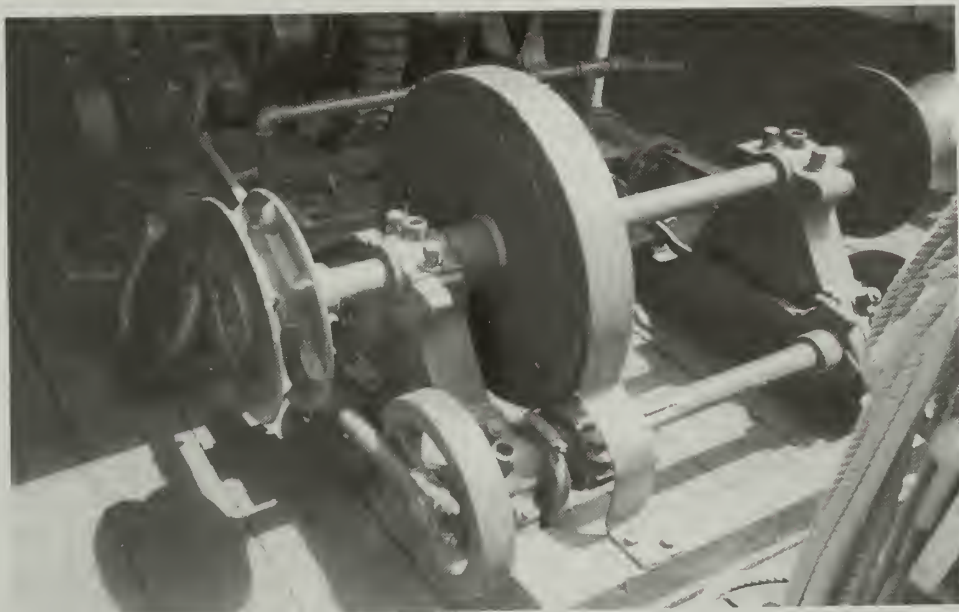
**Figure 4.27.** Feature PB-029. NPS photo by Adriane Neidinger.



**Figure 4.28.** Unidentified windlass element with widely-spaced teeth for the messenger chain on the left. Drawing by Matt Russell.

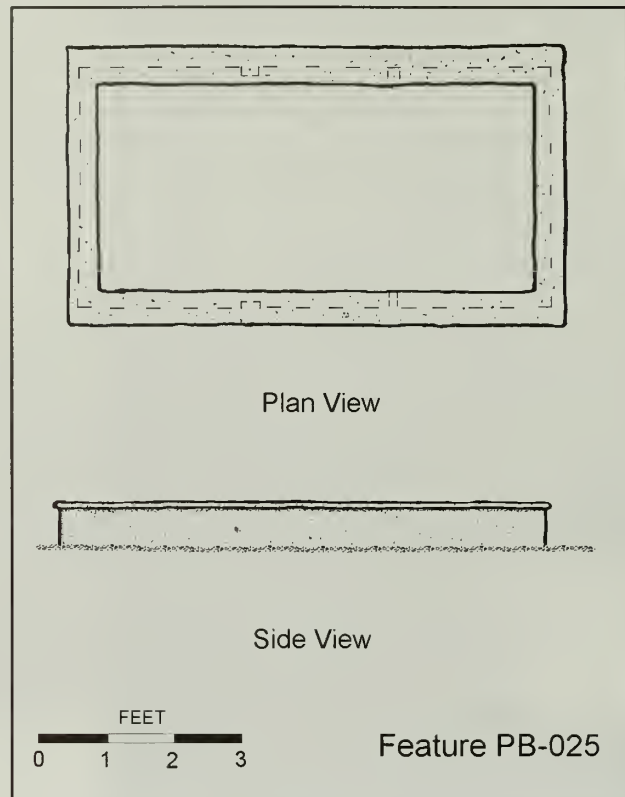


**Figure 4.29.** Feature PB-026 with the messenger chain gear at top. NPS photo by Adriane Neidinger.



**Figure 4.30.** Windlass from *Falls of Clyde* in Honolulu, Hawaii. Note the gear to the left in the photograph that is from the messenger chain system. NPS photo by Matt Russell.

**Figure 4.31.** Machinery mount for the donkey engine (feature PB-025). Drawing by Matt Russell.

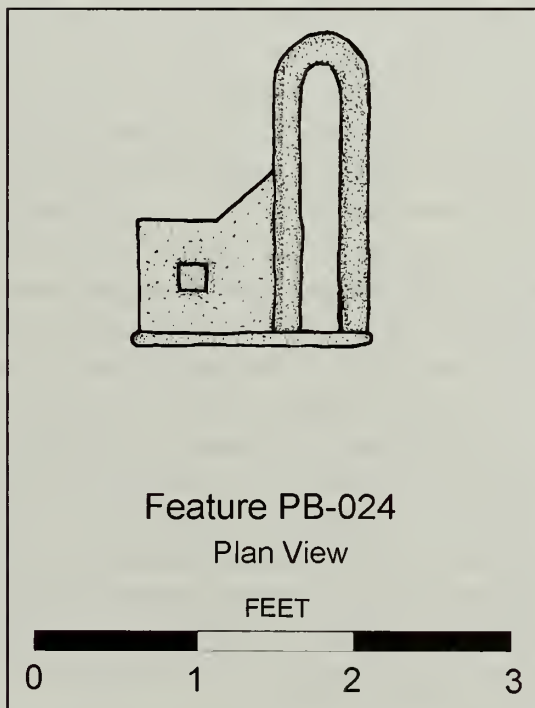


**Figure 4.32.** Feature PB-025. NPS photo by Adriane Neidinger.

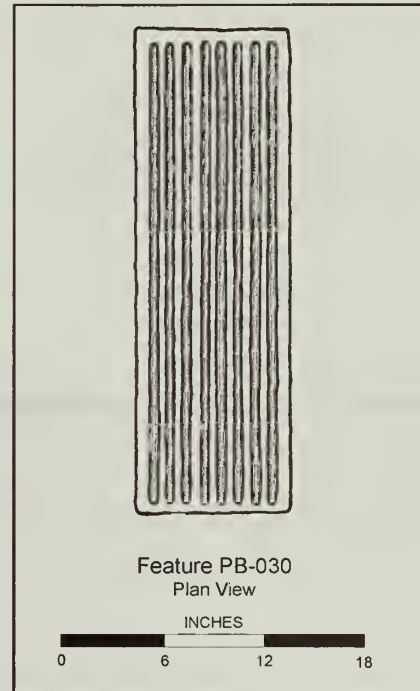


ocean-going vessels would have been much larger and constructed of wood. Feature PB-025 is probably the machinery mount for the donkey engine.

The remaining six intertidal features could not be conclusively identified. Feature PB-019 is a deteriorated piece of wood firmly embedded in the bottom, probably attached through the encrustation of various iron fasteners or fittings. Feature PB-024 is an oddly shaped iron object with rough dimensions of 1 ft. 11 in. x 1 ft. 6 in. The main attribute is a U-shaped piece of iron attached to a base (Figure 4.33). The object was only drawn in two dimensions because it is encrusted into the bottom and surrounded by thick marine growth. Heavily encrusted, feature PB-028 appeared only as a small ferrous lump covered with marine growth and no details could be observed. A scale drawing was not produced. Feature PB-030 is an iron block 2 ft. 4½ in. long,



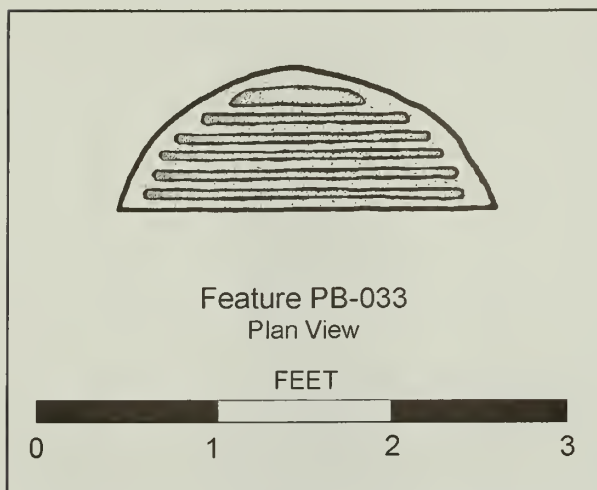
**Figure 4.33.** Unidentified object (feature PB-024). Drawing by Matt Russell.



**Figure 4.34.** Unidentified object (PB-030). Drawing by Matt Russell.

9 in. wide and 4½ in. thick (Figure 4.34). The top (exposed) surface has shallow grooves ½ in. wide and ½ in. apart running lengthwise for the whole width of the piece. A group of three iron fasteners concreted onto the rocks make up feature PB-032. Their lengths are 9 in., 1 ft. and 1 ft. 3 in.; the two shorter ones are approximately 1-in. diameter; the longer is about 1½ in. in diameter. Feature PB-033 is a small, half-moon-shaped iron object 2 ft. 1 in. long across its base, just over 9 in. wide at the broadest point, and 1½ in. thick (Figure 4.35). The top surface has six shallow grooves running lengthwise that are ½ in. wide with ¾-in. spaces between them. The bottom surface of the object is smooth.

Taken as a whole, the intertidal zone component of the Northwest Cove site is ground tackle and bow machinery from an ocean-going vessel. The most diagnostic features, the hawse



**Figure 4.35.** Unidentified object (feature PB-033). Drawing by Matt Russell.

pipes, belong to a vessel of roughly *J. M. Colman's* size. The donkey boiler, crosshead mechanism from a pump-brake windlass, and donkey engine, windlass and messenger chain system elements are all items expected aboard a typical Pacific Coast lumber schooner. Evidence for a single source of deposition comes from only two matched hawse pipes and a single representative of each iron object. This indicates the whole collection was deposited in a single wreck event by a single vessel. Even though several of the features cannot be positively identified, and the hawse pipe dimensions do not exactly match contemporary specifications, the assemblage taken as a whole is attributable to *J. M. Colman*.

#### WOODEN ELEMENTS AND FRAGMENTS

Unlike the iron features in the intertidal zone, it is not as easy to determine association of the wooden elements and fragments above the high tide line with *J. M. Colman*, or even a nineteenth century sailing vessel in general. Determination of association with *J. M. Colman* was based on several variables: size and characteristics of the

timber, evidence and size of fasteners, and wood species. Species identification was seen as the first-line cut for association. Hall-built schooners were constructed entirely of Douglas fir, with the exception of the stempost and sternposts, so any element or fragment that was not Douglas fir (unless from a stempost or sternpost) could not be associated with *J. M. Colman*.

Wood identification was conducted by PaleoResearch Laboratories of Denver, Colorado (Puseman 1994:6-7). Of the 15 wooden features recorded at the Northwest Cove site, all but one, and components of two others, were found to be Douglas fir. Timber PB-013 is *Juglans nigra* (Black walnut). Although the feature is more than 6 ft. long and nearly 1 ft. square in places, it contained only a single, small iron fastener in one end. This, combined with the wood species, rules out its association with *J. M. Colman's* structure.

Another feature that could be ruled out as coming from a wrecked vessel is PB-005. This feature consists of two timbers, each 5½ in. thick, 17½ in. wide and 16 ft. long held together with two iron fasteners and remnants of a third. The fasteners are 1-in. square and clinched over 3½-in.-round washers or roves. The fasteners also pass through 3-in.-square spacers located between the timbers. Even though the wood is Douglas fir, the feature is not consistent with ship construction of any period, and is more likely represents dock or pier construction.

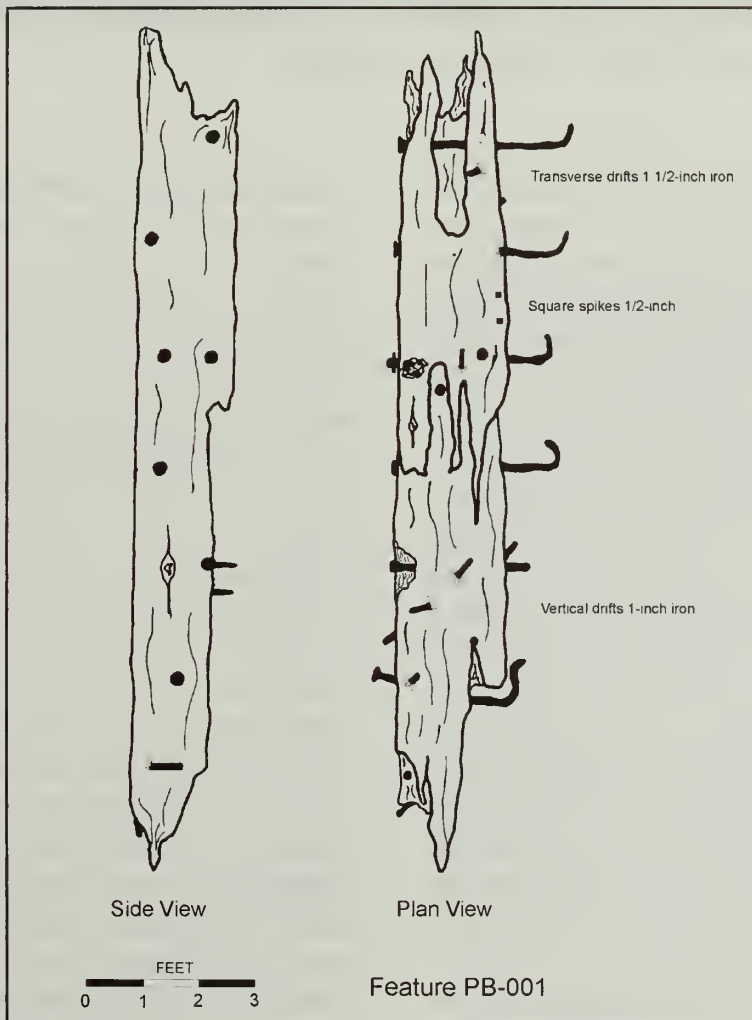
The remaining 13 features are Douglas fir and have fasteners consistent with late-nineteenth-century ship construction. This, however, does not make association with *J. M. Colman* a certainty. Further analysis indicates only four timbers are possibly structural hull elements from a vessel the size and age of *J. M. Colman*.

The first, feature PB-001, is a large, Douglas-fir element measuring 14 ft. 10 in. long, with maximum width and height of 23 in. x 21

in. (Figures 4.36 and 4.37). Both ends are broken off, so it is impossible to determine the element's original length. All extant surfaces are badly worn and deteriorated, so sided and moulded dimensions are approximate. The element's most conspicuous characteristics are size and number of iron fasteners. There are six large, iron drift pins driven through and protruding from the side. These drifts are approximately 1½ in. in diameter (though exfoliating badly) and range in length from 2 ft. 2 in. (broken) to 4 ft. 2 in. long spaced an average of 2 ft. apart. There are also nine 1-in. diameter

iron drifts and five spikes ½ in. square protruding from the timber's top surface. All are broken off close to the surface.

The element's size and fasteners make it likely this feature is part of a structural member from an ocean-going vessel. Furthermore, because of the element's large size and configuration of iron fasteners, it is most likely PB-001 is a portion of a vessel's centerline structure. The lack of rabbet, fasteners driven through both axis of the piece, and the observation that the large drifts were first driven through this piece and then, probably, into



**Figure 4.36.** Keelson element with iron fasteners (feature PB-001). Drawing by Matt Russell.



Figure 4.37. Feature PB-001. NPS photo by Matt Russell.

another makes it impossible for this piece to be a portion of a keel. On the other hand, these same characteristics are consistent with a piece of a main, sister, rider or assistant keelson, which now rests on its moulded face. The element's western face, from which the large iron drifts were driven, is likely the top, or sided, surface. If PB-001 is a piece of the main keelson, then the six 1½-in. diameter drifts were probably driven through this piece, through the floors and into the vessel's keel. If it is from a sister keelson, then the large drifts were probably driven through this timber into the floors or first futtock of the vessel. If this timber is from a rider or assistant keelson, then the large iron fasteners were probably driven through the piece into the main or sister keelson. In all cases, the 1-in. diameter fasteners driven through the opposite axis of the timber edge-bolted this timber to its adjacent keelson component, indicating multiple keelson elements.

Because *J. M. Colman's* original contract could not be located, it is impossible to verify on the basis of scantling dimensions whether this feature is a keelson portion from that vessel.

A comparison between the scantlings of *Comet* and the *Rules for the Construction of Wooden Vessels* offers a clue, however, as to whether association with *J. M. Colman* is likely. *Comet*, which had a gross tonnage of 429 compared to 463 for *J. M. Colman*, was built with a 16-in. x 20-in. main keelson, and a 14-in. x 18-in. sister keelson (J. Porter Shaw Library [JPSL]:Hall Brothers Shipyard Contract Number 49, 1886). Because *J. M. Colman*, the second largest three-masted schooner built on the Pacific Coast, was larger than *Comet*, the centerline structure would also be larger. Therefore, scantling dimensions of approximately 21 in. x 23 in. for one of the keelson components is reasonable for *J. M. Colman*. The *Rules for the Construction of Wooden Vessels* published by the American Shipmaster's Association (later the American Bureau of Shipping) for the year 1879 required a vessel of 400 gross tons to have a keelson and riders measuring approximately 13 in. x 32 in. These rules were intended as a minimum standard for insurance evaluation purposes and allowed differing dimensions as long the

alteration did not lessen the strength of the structure as a whole (Desmond 1919[1984]:24). By comparing *Comet's* keelson dimensions to the rules, it can be seen that the Hall Brothers did alter their timber measurements. The rules cannot, therefore, be used as the sole determinate for possible scantling dimensions of *J. M. Colman*, but are most helpful to separate likely components of these vessels.

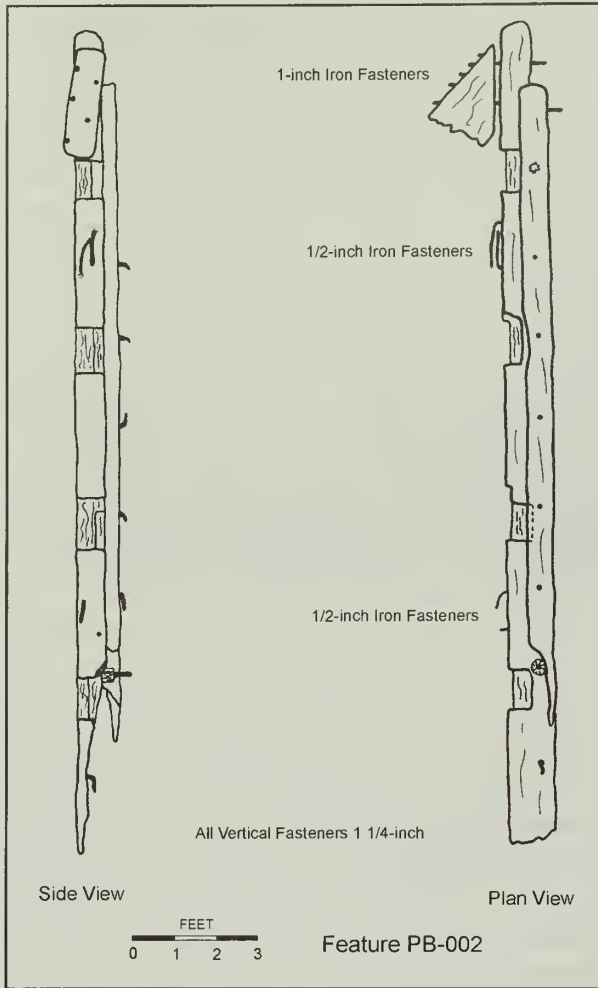
*Comet's* contract specifies that iron fastenings 1¼ or 1 1/8 in. in diameter be used to fasten the keelson. Because *J. M. Colman* was larger than *Comet*, 1½-in. iron drifts to fasten the keelson would be consistent. Another possibility is that the expansion caused by the corrosion process of the iron fasteners made the 1½-in. measurement larger than the original diameter. In either case, these fasteners reflect probable association with *J. M. Colman*.

During this analysis, I observed that the wood around the large fasteners on the east face of the timber is considerably more worn than the rest of the surface. There is no obvious explanation for this disparity. It is possible that this differential weathering is a function of the natural deterioration process of the Douglas fir, such as differential preservation of heartwood versus sapwood, caused by exposure over 80 to 90 years and not significant archeologically. On the other hand, it is also possible that this deterioration took place while the vessel was still in use. If the latter is the case, this wear might be an archeological signature of extended use and age of the vessel from which this timber came. Differential weathering of Douglas fir around iron fasteners is not historically documented. As discussed in Chapter 2, Hopkins (1874:9–10) noted that Douglas fir held iron fasteners with tenacity, that the iron would break before it could be withdrawn from the timber, and that iron did not deteriorate in fir as it did in oak. There is no mention of a problem

with fir breaking down over time around iron fasteners, although even if this were known, it is unlikely it would be noted in a paper advocating the use of fir as a shipbuilding material. On the other hand, classification rules specify fewer years of use for pine and fir than oak. Further study and comparisons to other examples are necessary to test the validity of this observation.

Another feature that is likely a scantling piece from a large, ocean-going vessel is PB-002 (Figures 4.38 and 4.39). This fragment consists of three wooden components: two long, rectangular pieces, one on top of the other, and a small trapezoidal piece fastened to the bottom timber. Also present are numerous iron fasteners. The bottom timber's total length is 19 ft. 8 in., it is 1 ft. 2 in. wide and 8 in. thick. This piece contains four mortises cut into its west side, which measure between 10 in. and 1 ft. 1 in. long, 3½ in. high, and 5½ in. deep. The mortises are indented about 1½ in. from the side. The top timber, which was originally fastened to the bottom piece with eight 1¼ in. in diameter iron drift pins spaced 2 ft. on center, is 15 ft. 6 in. long, 8 in. wide, and 4 in. thick. On the feature's north end, a trapezoidal piece 2 ft. 2 in. long, 1 ft. 7¾ in. wide, and 8 in. thick is fastened to the lower timber with five iron, 1-in. diameter drift pins. In addition to these fasteners, the fragment also has two pairs of additional ½-in. diameter drifts in its west face.

Attributes of this feature suggest identification as a deck clamp or shelf. The mortises, spaced on 4-ft. centers, would have received the deck-beam ends. Deck beam spacing corresponded to frame spacing, so that the end of each deck beam rested against a frame (Desmond 1919[1984]:105). Generally, a vessel framed on 2-ft. centers would have a deck beam for every other frame, with deck beam spacing not exceeding 5 ft. (American Shipmasters'



**Figure 4.38.** Feature PB-002. This fragment is possibly part of a deck clamp or shelf. Drawing by Matt Russell.

**Figure 4.39.** Feature PB-002. NPS photo by Matt Russell.



Association 1879:23). The trapezoidal piece was a reinforcing chock, butted between the clamp and the deck beam.

There are several problems with this interpretation, however, and several questions to be answered before it can be wholly accepted. First, the mortises extend only about half the width of the bottom timber. Normally, the deck beam rests on the full width of the clamp, not just half. Second, a main-deck clamp would have been firmly fastened to the vessel's frames with large through-bolts driven from the outside and clinched (Desmond 1919[1984]:104). There is no evidence of any large fasteners or holes coming through the bottom timber transversely. Third, between the mortises, evidence of more reinforcing pieces like that found on the end of the feature would be expected. However, there are only two pairs of ½-in. fasteners, nothing like the five 1-in. drifts

that fastened the first reinforcing piece to the bottom timber.

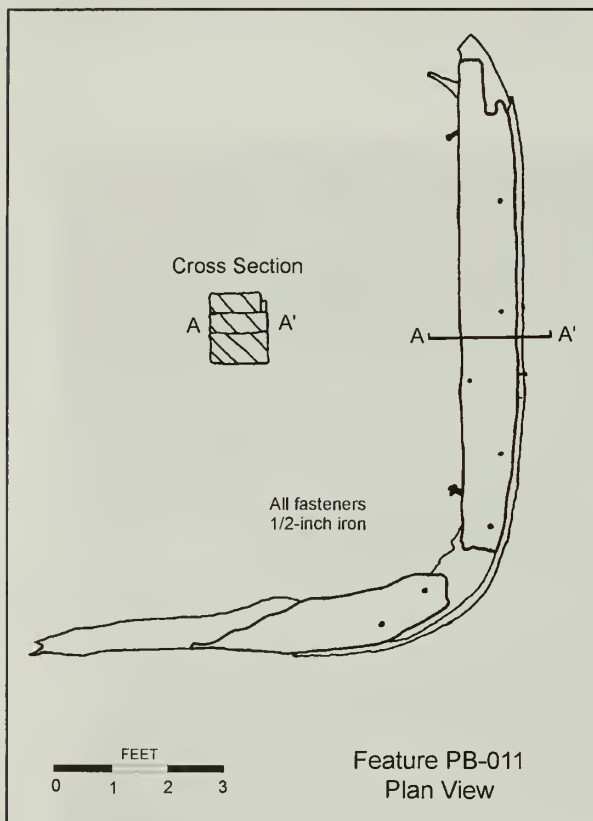
Finally, one of the most puzzling aspects of this fragment is that at least two of the vertical 1¼-in. fasteners joining the top timber to the bottom timber are driven through oak plugs (Figure 4.40). Only two could be examined, so it is possible that the remaining fasteners were also driven through plugs. Research into this practice has been inconclusive. It is unknown if this represents an effort to strengthen the bonding of these two timbers, or if this is evidence of a repair meant to replace a corroded fastener or possibly to augment wood that had deteriorated around the fastener. This may represent a peculiar and undocumented practice of the Hall Brothers. Identification as a portion of a deck clamp or shelf should be viewed as tenuous, especially when considering association with *J. M. Colman*.



**Figure 4.40.** Iron fastener driven through an oak plug on feature PB-002. NPS photo by Matt Russell.

Features PB-011 and PB-014, constructed in the same manner, likely represent pieces of a wooden hatch coaming (Figures 4.41–4.44). The two fragments each have three layers of timbers, fastened together with ½-in. diameter, round iron fasteners. Originally, the structure was either U-shaped or, more likely, rectangular with rounded corners. PB-011 is sitting upright, with the three layers stacked, while PB-014 is laying face-down with the three layers side by side.

Feature PB-011's bottom timber is 6½ in. thick, the middle timber is 5 in. thick, and the top timber is 7 in. thick, giving PB-011 a total height of 18½ in. Each of the timbers is 1 ft. wide. Feature PB-011 is roughly L-shaped, with the longest side 11 ft. long, and the shorter 8 ft.



**Figure 4.41.** Plan view of feature PB-011, possibly part of a hatch coaming. Drawing by Matt Russell.

long; both ends are broken. The end of the longer side exhibits the beginning of a curve before the fracture. Feature PB-014 shows the beginning of a curve on one end before it is broken off, as well. In the one intact curve on PB-011, the two timbers forming the bottom layer meet in the middle of the curve. The timbers of the two top layers are joined in the curve by a chock. Feature PB-014 has shallow mortises along what would be the inside edge of the top timber, if it were standing upright. These mortises are 6 in. long, 3 in. wide with a maximum depth of 1½ in. The shorter length of PB-011 exhibits identical mortises on its inside face, suggesting that PB-014 was originally connected to PB-011 opposite their shorter length.

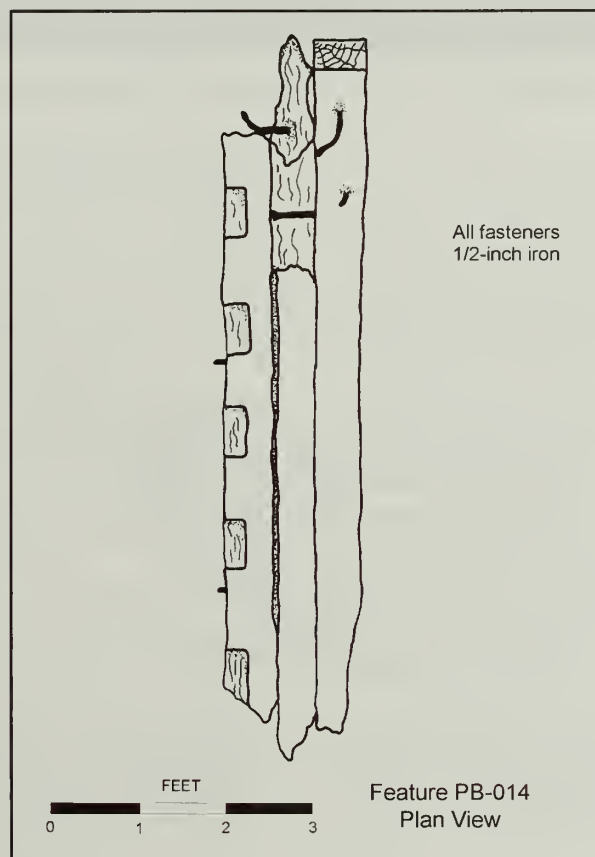
Each layer of wood on feature PB-011 is faced on the outside edge with thin, horizontal planks ¼ in. thick. These are nailed to the main timbers with ¼-in. round nails. Wood species analysis identified these planks as *Quercus virginiana* or live oak. The main timbers were Douglas fir. It could not be determined if PB-014 included similar planks because the side they would have been attached to was face-down. The plank nailed to the top layer of PB-011 is only 4¼ in. wide, so it extends only about half the thickness of that timber. This, in effect, leaves a 2¾-in. deep, 1¼-in. wide rabbet around the outside of the structure's top face.

Positive identification of these fragments is difficult, but attributes are consistent with a hatch coaming, or deck structure coaming of a large vessel. Both hatch and house coamings resembling this structure are depicted in W. H. Curtis *The Elements of Wood Ship Construction* (1919:131, 152, 199, 201)(Figure 4.45). There is evidence to support this speculation and problems with this possibility, as well. In addition to the similarity to the structures depicted in Curtis, mortises cut into the top, inside edge of PB-014 and the shorter length of





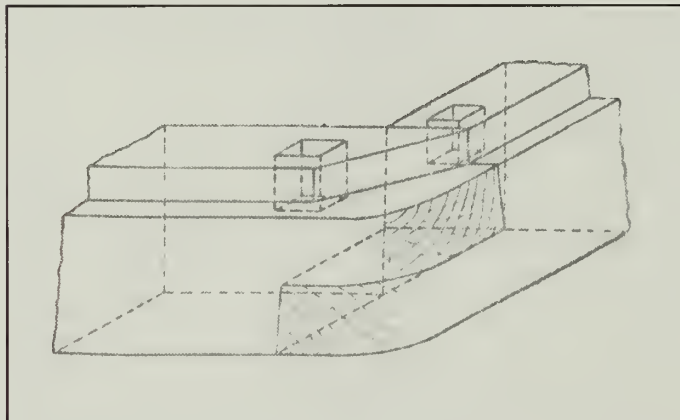
**Figure 4.42.** Oblique view of feature PB-011. NPS photo by Matt Russell.



**Figure 4.43.** Plan view of feature PB-014, likely part of the same coaming as feature PB-011. Drawing by Matt Russell.



**Figure 4.44.** Feature PB-014. NPS photo by Matt Russell.



**Figure 4.45.** Hatch coaming depicted in Curtis 1919:200.

PB-011 support the possibility of the structure being a hatch coaming. Hatch coamings contained a number of removable beams that criss-crossed the opening of the coaming. These beams, the transverse ones called strongbacks and the longitudinal ones called, simply, fore-and-aft beams, supported the hatch cover. These supports were necessary because the hatch cover had to support a great weight of deck cargo, particularly on lumber schooners where much of the cargo was carried on deck. These beams were supported on their ends by mortises cut into the coaming. One problem with this identification is that the hatch coaming would be securely fastened to the hatch framing with closely spaced, large, iron through-bolts (Curtis 1919:133). PB-011 has only five ½-in. diameter vertical fasteners along its entire 11-ft. length. It is possible, however, that either the lowest or the lower two layers were securely fastened to the hatch framing, and then the top layer fastened to them, thereby hiding the large through-bolts.

There is also support for this structure being a deck-house coaming. These coamings contained a shallow rabbet around the outside top edge to receive the first plank of the house siding. The outside planking on PB-011 forms such a rabbet. This supposition also has a problem. If this was a deckhouse coaming, then the top surface should have a series of mortises cut into it to receive the studs that supported the house walls. The top surface of PB-011 displays no such mortises.

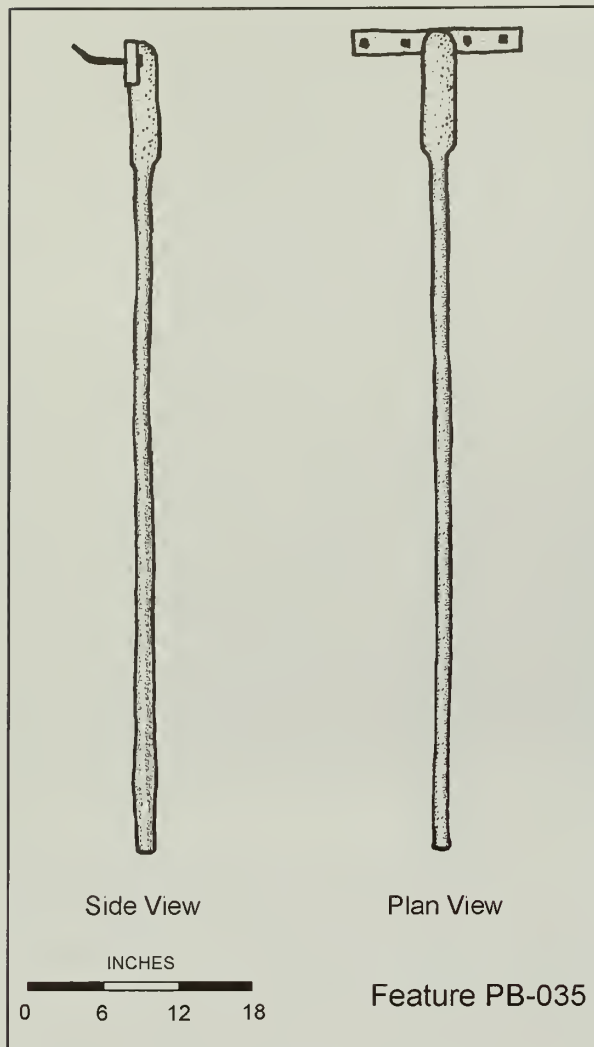
If these structures represent a coaming from *J. M. Colman*, then it is probably not a house coaming. Unfortunately, neither *Comet's* contract nor the *Rules for the Construction of Wooden Vessels* specify such nonstructural elements. If, however, we can use *C. A. Thayer*, a lumber schooner preserved at San Francisco National Maritime Historical Park, as a model, it can be seen that the deckhouses would have been larger than the structure represented by PB-

011 and PB-014. The after deckhouse of *C. A. Thayer* measures approximately 22 ft. wide x 20 ft. long, while the forward deckhouse measures about 16 ft. wide x 35 ft. long. Because *C. A. Thayer* is narrower than the 37-ft. beam of *J. M. Colman*, it is likely that *J. M. Colman's* deck structures would have been slightly wider than *C. A. Thayer's*.

Original dimensions of the structure represented by PB-011 and 014 was about 11 ft. long x 8 ft. wide. This is too small to be a deckhouse coaming or main hatch coaming, which measures about 21 ft. x 12 ft. on *C. A. Thayer*. Although the main-deck arrangement of *J. M. Colman* is unknown, *C. A. Thayer* has an additional small cargo hatch forward of the main hatch, though aft of the forward deckhouse, which measures about 12 ft. wide x 9 ft. long. Therefore, the most likely interpretation is that the structure represented by PB-011 and 014 is part of the forward hatch coaming from *J. M. Colman*.

As a whole, analysis of the remaining nine features remains inconclusive. The only certainty about these features is that they are too light to be structural members of *J. M. Colman*. If any of these remaining nine features are from *J. M. Colman*, then they are nonstructural elements. All nine are Douglas fir, all exhibit characteristics possibly from a late-nineteenth-century, ocean-going vessel, and yet all nine could just as easily be from a pier, fence or some other origin. The fact that all could have floated to their present location makes their association with a vessel wrecked on Point Bennett speculative.

As mentioned earlier, a single, unidentified iron piece, feature PB-035, was recorded above the high-tide line at Northwest Cove (Figure 4.46). This feature is a 4 ft. 8 in. long, 1¾-in. square iron bar, which ends in a 2-in. diameter, 10-in. long round portion. Connected to the bottom of the round end is a 1 ft. 3 in. x 3½-in.



**Figure 4.46.** Unidentified object (feature PB-035). Drawing by Matt Russell.

rectangular piece, so that the whole object forms a “T.” This rectangular piece has four ½-in. square spikes through it. This object has not been identified.

All in all, the collection of wooden elements and fragments found above the high-tide line in Northwest Cove does not offer the same degree of confidence of association as the iron material in the intertidal zone. Of the fifteen wooden elements and fragments, only one, Feature PB-001, a keelson element, is definitely from a large,

wooden vessel, probably *J. M. Colman*; features PB-002, 011 and-014 are all likely associated, but cannot be conclusively identified. The rest offer few diagnostic clues.

### CLUSTER POINT SITE

Analysis of the Cluster Point site was conducted in the same manner as the Northwest Cove site. The 22 elements and fragments are individually discussed on the basis of size, shape and fasteners present, and speculation offered as to their nature and association with *Dora Bluhm*. Unlike the case at Northwest Cove, this process was expedited through scantling dimensions supplied in the surviving contract for *Dora Bluhm*.

Previous research by CHIS archeologist Don Morris identified several features of a wooden sailing vessel that no longer exist at the site. The ocean may have removed two of these features, while the third was definitely removed by looters. While all three features were undoubtedly from a wooden sailing vessel of construction consistent with late-nineteenth-century practices, an association with *Dora Bluhm* remains inconclusive.

The first feature is an iron mast-band with an internal diameter of 21½ in., composed of two half-bands connected by a horizontal iron bolt on each side. This mast band is possibly either the mast-band from the lower mast collar, or the two half-bands that support the futtock shrouds, below the trestletree. The size matches the mizzenmast diameter of *Dora Bluhm*, as stated in the original contract (J. Porter Shaw Library [JPSL]:Hall Brothers Shipyard Contract Number 40, 1883). Although this feature is probably from *Dora Bluhm*, there is a chance that it was carried to Cluster Point attached to a mast from some other shipwreck. Morris located this item in March 1990 at a cattle rancher’s line camp on the bluff above the beach,

just south of Cluster Point. At that time it was being used as a fire ring, and it has since disappeared (Figure 4.47).

The second feature reported by Morris is an iron hawse pipe measuring 3 ft. 5 in. long, with an external diameter of 9½ in. Originally located in the rocks to the south of Cluster Point, it could not be relocated during the present study (Figure 4.48). According to the tables found in Desmond (1919[1984]), a vessel of 300 tons (*Dora Bluhm* registered 330 gross and 315 net tons) required a hawse pipe measuring 11½ in. in diameter. This hawse pipe appears to be more appropriate for a vessel of approximately 150 tons (Desmond 1919[1984]:157), but this does not discount association with *Dora Bluhm*. It has already been demonstrated that dimensions were sometimes altered from published rules, as long as overall strength was not compromised.



**Figure 4.47.** Iron mast-band used as a fire ring at Cluster Point. This object has since disappeared. NPS photo by Don Morris.

Unfortunately, there is no way to be certain whether this hawse pipe is from *Dora Bluhm* or not.

The third feature has been identified as the top of a rudder stock, which bears the yoke that attached it to a diamond-cut-screw steering gear (Don Morris, personal communication 1993; Figures 4.49–4.51). It consists of a worn wooden piece 12 in. in diameter clamped into an iron yoke, which is 10 in. wide. The iron yoke is composed of halves, connected by two iron fasteners on each side. Although there is no size comparison available, there are two pieces of evidence that support a *Dora Bluhm* association. First, the original contract for this schooner states that it was equipped with a diamond-cut-screw steering gear (JPSL 1883). Second, although not sampled for species identification, field observations by Morris indicate that the wooden portion of the feature, the top of the rudder stock, was hardwood, possibly oak. These two clues make this feature's association with *Dora Bluhm* likely. Unfortunately, this feature disappeared from the beach shortly after Morris recorded it in October 1988.

The remaining discussion focuses on features recorded during 1993 fieldwork. All 22 elements and fragments analyzed and sampled were Douglas fir, so none could be discounted immediately, as with the Northwest Cove site (Puseman 1994:6–7). One timber, however, feature CP-009 (Figure 4.52), has a wooden component identified as a member of the Fabaceae family, probably ironwood (Puseman 1994:6–7). This is not a wood usually used in ship construction. The ironwood pieces are two narrow planks 3 ft. 2 in. long, 3½ in. wide and 3½ in. thick, which are fastened to either side of a large, extremely deteriorated Douglas fir timber measuring 14 ft. 8 in. x 17 in. x 16 in. As found, the ironwood planks are fastened along the timber's bottom edge, on the western end.



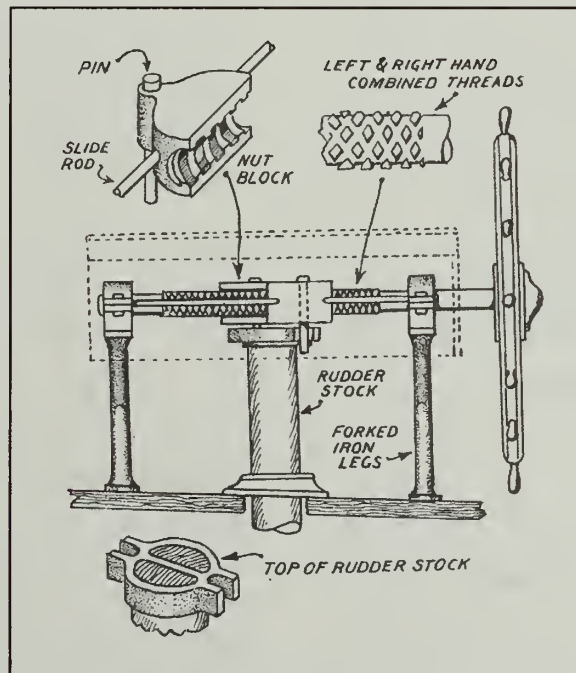
**Figure 4.48.** Hawse pipe located near Cluster Point. NPS photo by Don Morris.



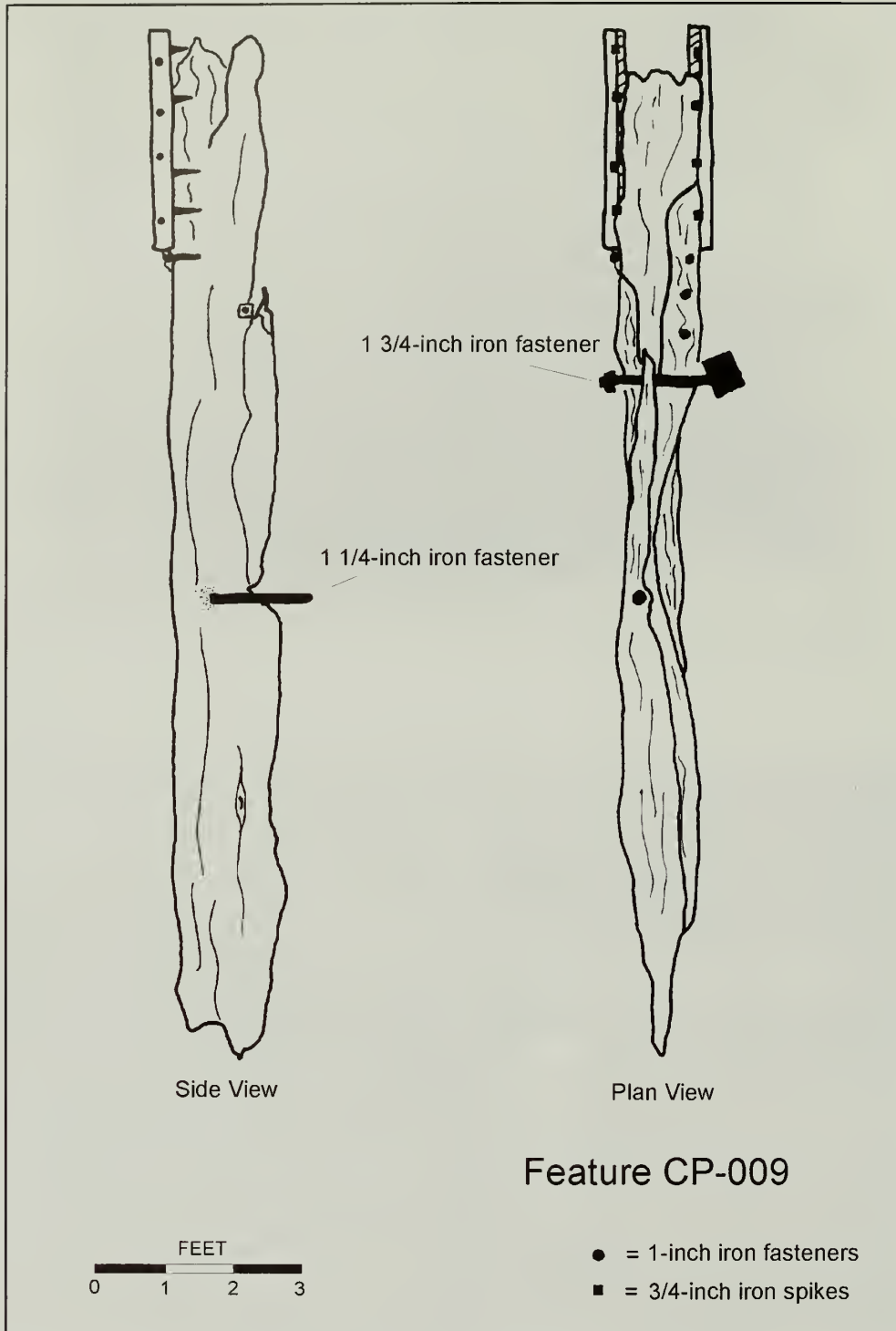
**Figure 4.49.** Portion of a rudder stock with the iron yoke that attached it to diamond-cut screw steering gear. NPS photo by Don Morris.



**Figure 4.50.** End view of the yoke attached to the end of a rudder stock. NPS photo by Don Morris.



**Figure 4.51.** Top of rudder stock depicted with yoke that attached it to a steering gear (from Campbell 1974:127).



**Figure 4.52.** Feature CP-009, likely not part of *Dora Bluhm*. Drawing by Matt Russell.



Four horizontal spikes, driven from the outside face and four vertical spikes, driven from the bottom, fasten each piece. Each iron spike is countersunk into the ironwood, and plugged with an ironwood plug. The main Douglas fir timber contains four vertical 1-in. diameter drift pins grouped near the ironwood planks; one 7/8-in. square spike; one 1¼-in. diameter vertical drift pin; and one horizontal 1¾-in. diameter bolt with a 1¾-in. square nut on one end, and a 6-in. square spacer on the other. The latter fastener's function is unknown, but it is not consistent with common late-nineteenth-century ship construction. This fastener arrangement, coupled with the relatively few fasteners in a timber this size and the unusual ironwood pieces, make this fragment's association with *Dora Bluhm* unlikely.

Another feature probably not associated with a vessel of any kind is CP-021. This feature is an extremely large timber, 16 ft. 9 in. long and about 1 ft. wide and rounded in cross-section. In its entire length it only has four 1-in. diameter drifts and three ½-in. spikes. Because of the element's size, shape and the small number of fasteners in it, feature CP-021 is probably not related to *Dora Bluhm*.

On the basis of timber size and the number and size of fasteners, 9 of the remaining 20 timbers examined are possibly structural members of a late-nineteenth-century sailing vessel; the remaining 11 are not structural.

Of the nine structural members, features CP-001, 010 and 012 are all similar Douglas fir elements with large, iron fasteners (Figures 4.53–4.55). The first (CP-001), heavily abraded and worn, is 14 ft. 10 in. long, with maximum dimensions of about 15 in. x 13 in. Both ends of the element are broken; original length is indeterminate. There are ten vertical, iron drift pins along its length, and there is an empty hole for an eleventh. Six drift pins are 1¼ in. in diameter (though slightly expanded by

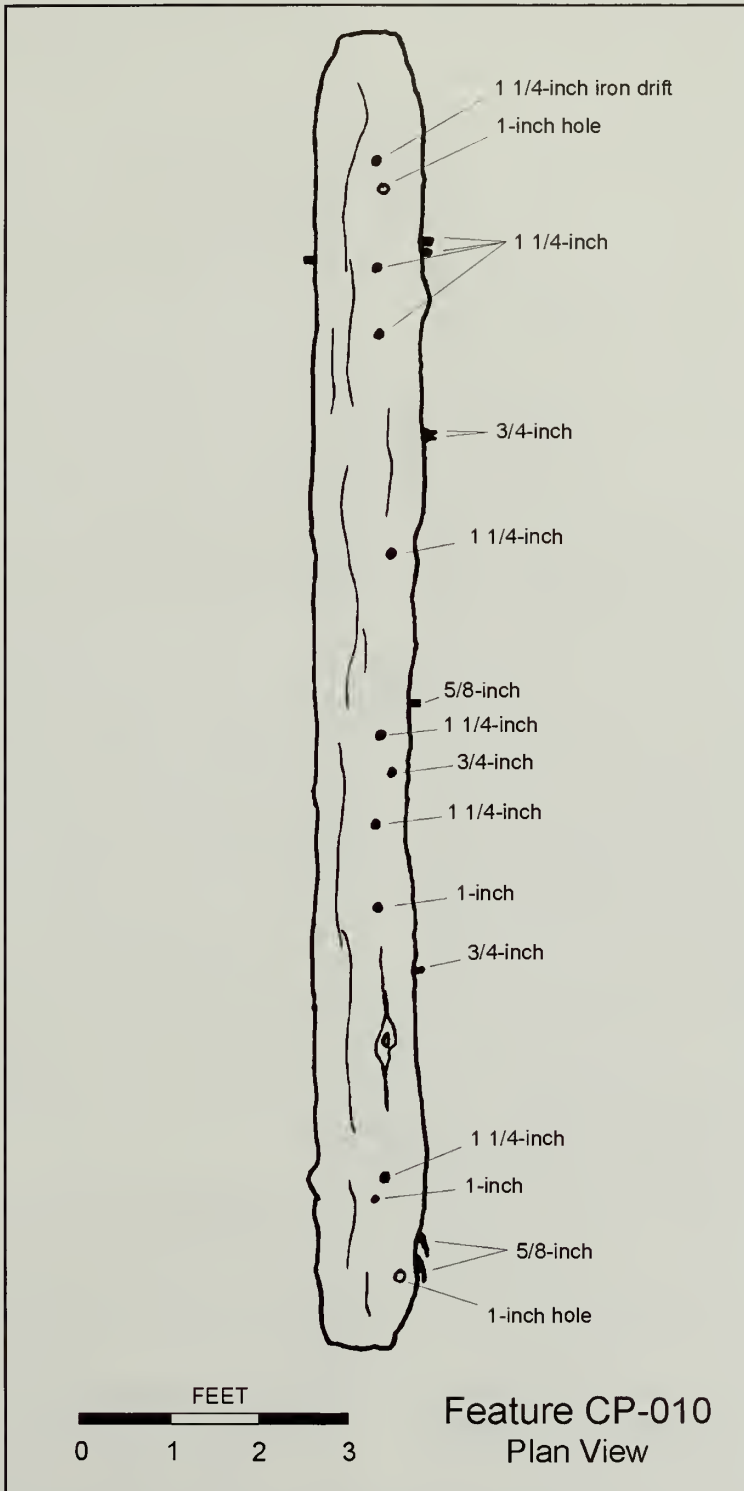
corrosion), four measure 1 in. diameter, and the empty hole is 1 1/8 in. diameter. These fasteners are grouped roughly in pairs (including the empty hole): the paired pins are approximately 1 ft. apart, and the pairs are about 2 ft. apart. One pair has an additional 1-in. diameter drift between them. These vertical fasteners are broken close to the timber on both sides. In addition to the vertical fasteners, there are several transverse drift pins and spikes including four ½-in. square spikes and two ¾-in. diameter drift pins with 2-in. diameter (possible) clinch rings on one end. The two drifts are paired and 9 in. apart. The drifts protrude from the timber 7 in. on the ends with the clinch rings. There is no other evidence of fasteners on the timber's side faces.

Feature CP-010 is 14 ft. 9 in. long (broken at both ends), with maximum dimensions of 15 in. x 11 in., though somewhat deteriorated, and contains ten vertical iron drift pins along its length, and holes for two more. These fasteners (and holes) include seven 1¼-in. diameter pins, four 1-in. diameter pins, and a single ¾-in. diameter pin. The element also contains transverse fasteners: a pair of 1¼-in. diameter drift pins; a pair of ¾-in. diameter drifts; a single 5/8-in. diameter drift; another, single ¾-in. diameter drift; and a pair of 5/8-in. diameter drifts. There is no discernible pattern to fastener spacing.

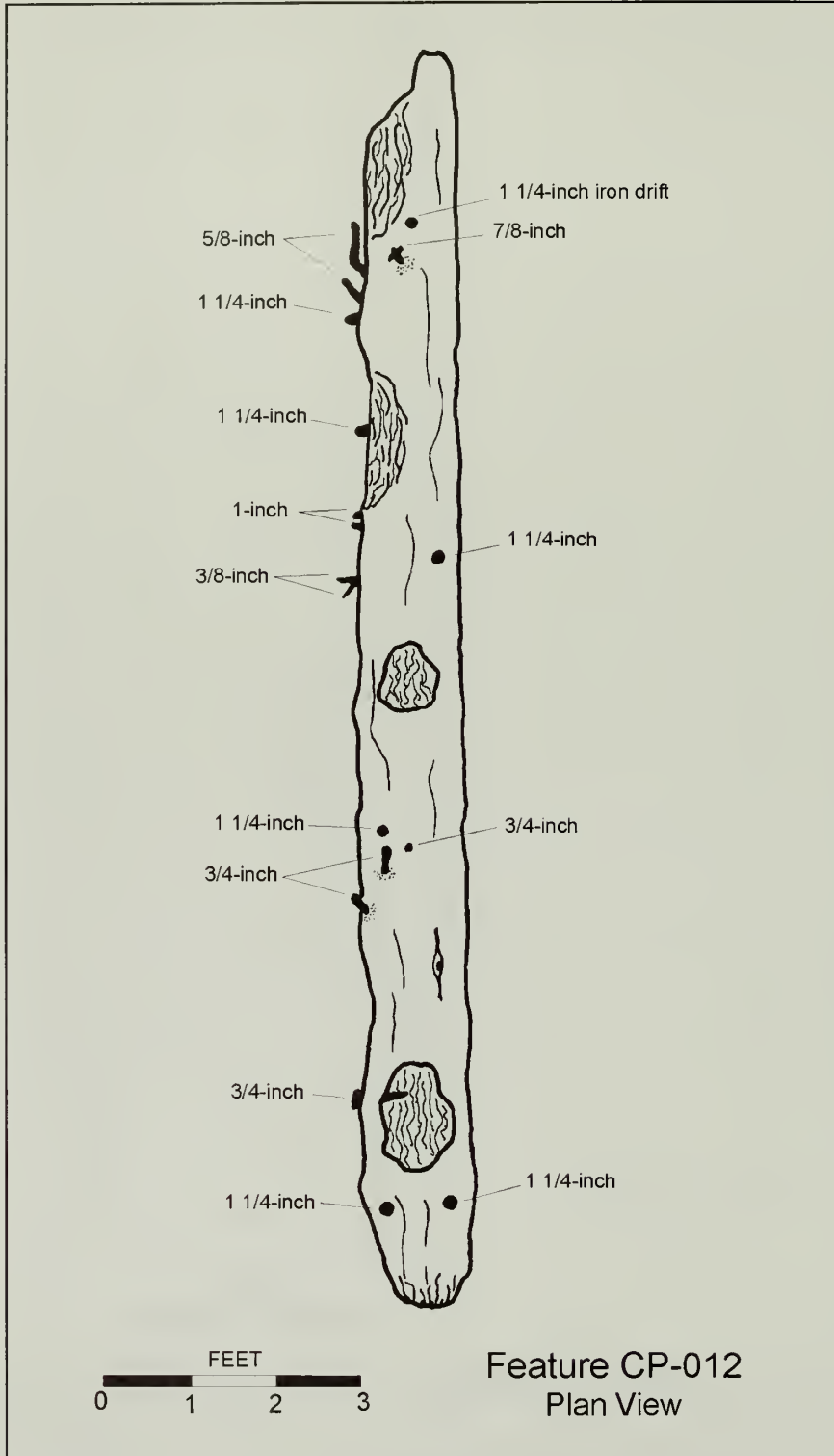
Feature CP-012 is a similar element, measuring 14 ft. 3 in. long (broken at both ends), with maximum dimensions of 14 in. x 13 in., again with some deterioration. The most conspicuous features of this element, besides the fasteners, are two large holes penetrating all the way through the timber, apparently caused by some kind of differential deterioration. There are no large fasteners in or around these holes, so it is unknown if the deterioration was centered on iron drift pins, as seen in feature PB-001. Like the two previous features, CP-012 has



**Figure 4.53.** Keelson element with iron fasteners (feature CP-001). Drawing by Matt Russell.



**Figure 4.54.** Keelson element with iron fasteners (feature CP-010). Drawing by Matt Russell



**Figure 4.55.** Keelson element with iron fasteners (feature CP-012). Drawing by Matt Russell.

several vertical, as well as transverse, iron fasteners. The vertical fasteners include five 1¼-in. diameter drift pins, three ¾-in. diameter drifts, and a single 7/8-in. diameter bolt with a 1-in. square nut on the end. The transverse fasteners consist of two 5/8-in. diameter round drifts, two 1¼-in. diameter drifts, two 1-in. diameter drifts, two 3/8-in. diameter round spikes, and a single ¾-in. diameter round drift.

The size, shape and fasteners of these three features indicate these timbers are structural members from a large, wooden vessel, most likely pieces of a vessel's centerline structure. Like PB-001, lack of a longitudinal rabbet and presence of transverse fasteners precludes these elements from being a keel, but rather indicate they are portions of either the main, sister, assistant or rider keelsons.

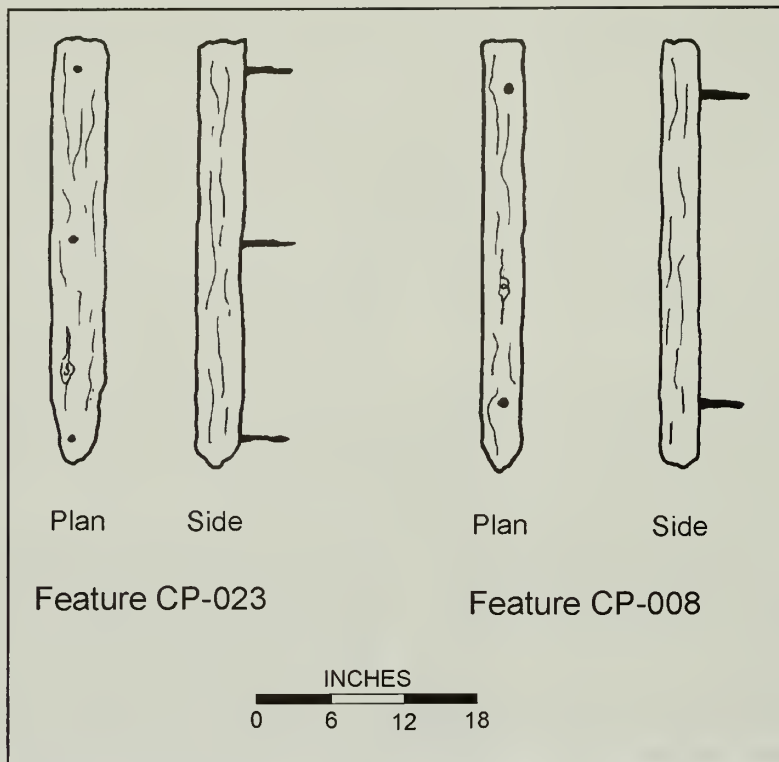
The original contract for *Dora Bluhm* aids interpretation of these timbers. The contract specifies the main keelson was to be sided 16 in. and moulded 16 in., while the sister keelson was to be sided 12 in. and moulded 18 in. (JPSL 1883). If features CP-001, 010 and 012 are keelson elements, then, based on sided and moulded dimensions, CP-010 could be either part of the main or sister keelson, while CP-001 and 012 could only be part of the main keelson (taking into account some deterioration). Assistant and rider keelsons are not mentioned in the contract.

In addition to specifying timber dimensions, the contract required the keelson to be fastened with 1 1/8-in. iron fasteners. In all likelihood, all 1¼-in. measurements for the fasteners in CP-001, 010 and 012 are greater than the original measurement because of expansion caused by iron deterioration. This observation is supported by the single 1 1/8-in. diameter hole found on CP-001, which is assumed to be unaltered. Therefore, it is likely that the 1¼-in. diameter fasteners recorded on all three timbers were originally 1 1/8-in. iron fasteners. This does not,

however, account for the additional smaller fasteners found in these three timbers. It is conceivable that smaller iron was used in the transverse fasteners to edge-bolt the main and sister keelsons together. There is no mention in the contract of smaller iron in the vertical through-fasteners that fastened the keelson through the floor into the keel, or the sister keelson into the floor or futtock. These smaller fasteners remain unexplained. It is, nonetheless, probable that features CP-001, 010 and 012 represent portions of the keelson structure of *Dora Bluhm*.

Two features that may represent small portions of structural members are features CP-008 and CP-023 (Figure 4.56). Both features are 3 ft. long and nearly square in cross-section. Feature CP-008 is 3½ in. wide and 3¼ in. thick; all its faces are extremely worn. It contains two round spikes 2 ft. 2½ in. apart. One is ¾ in. diameter and the other is 7/8 in. diameter, though both are exfoliating badly. Feature CP-023 is slightly more than 4 in. wide and 3 7/8 in. thick; all its faces are also very worn. It contains three iron spikes, all ½ in. diameter. The first and second spikes are spaced 1 ft. 2 in. apart, and the second and third are 1 ft. 5 in. apart.

*Dora Bluhm's* contract calls for 4-in. x 4-in. main-deck planking (JPSL 1883). With deterioration taken into account, either element could be a piece of main-deck planking. Fastener spacing cannot be used as an indicator for identification of these features because it is possible that spikes were fastened into carlins or lodging knees and not only into deck beams. The fasteners may have been countersunk and plugged, which is typical practice for main-deck planks; the plugs have since disappeared and the face deteriorated enough to hide traces of countersinking. It is probable that features CP-008 and CP-023 represent portions of the main-deck planking of *Dora Bluhm*.



**Figure 4.56.** Deck planking elements with iron fasteners.  
Drawing by Matt Russell.

Feature CP-017 is also a structural member from a large, wooden sailing vessel (Figure 4.57). The extremely deteriorated wood element is 3 ft. 4 in. long, 7 in. wide and 10 in. thick. It contains, however, five 1½-in. diameter iron drift pins (the longest 3 ft. long), and a 2-in. diameter iron eye-bolt with a 6½-in. outside diameter ring attached. The eye-bolt and ring represents a tie-down point, which could have been placed in many locations on the vessel. The five fasteners' original measurements were considerably smaller, accounting for expansion caused by iron corrosion. The largest fasteners required in the *Dora Bluhm* contract were 1 1/8-in. drifts for the keel, keelson, stempost and sternpost. Feature CP-017 likely represents a small portion of any of these components.

Another probable structural member of *Dora Bluhm* is CP-022 (Figure 4.58). This

fragment is composed of two timbers, each with an original width of 12 in. and surviving lengths of 12 ft. 10 in. The timbers are edge-bolted together with four 1¼-in. diameter drift bolts. The four fasteners originally edge-bolted at least two more timbers to the two surviving pieces, one on each side. The timbers have a present thickness of 5 in., but the undersides are extremely deteriorated, so they were originally thicker. The fasteners are slightly expanded, so they were probably originally 1 or 1 1/8 in. diameter.

At first glance, it appears this fragment may be a portion of ceiling or outer-hull planking, both of which were often edge-bolted (Desmond 1919[1984]:57–59). But this feature does not have evidence of fasteners coming through the face; both ceiling and outer hull planking would have numerous large fasteners attaching them



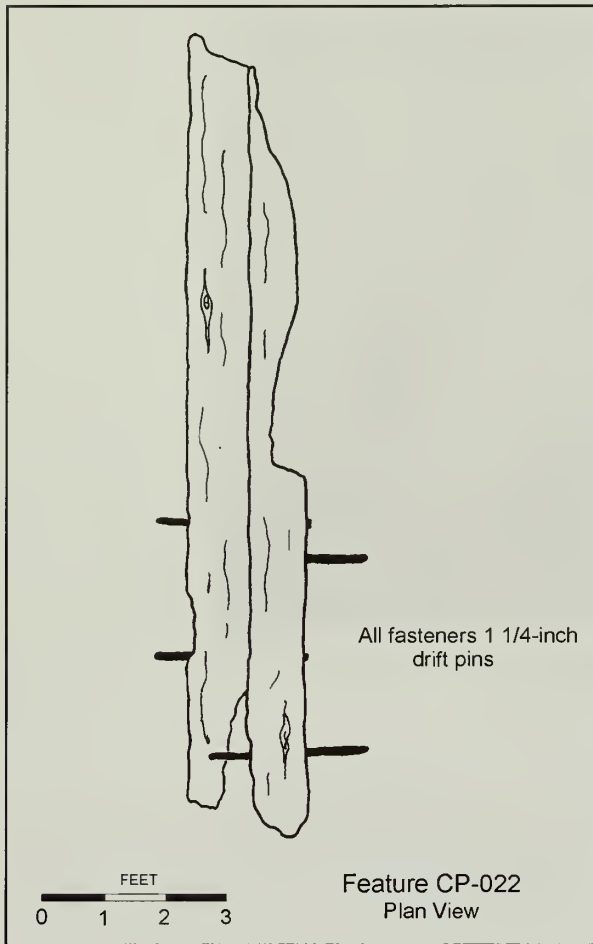
**Figure 4.57.** Unidentified element with large iron fasteners. NPS photo by Matt Russell.

to every frame. Another possibility, since *Dora Bluhm* was built with a centerboard, is that feature CP-022 is a portion of the centercase. The vessel's contract specifies the centercase was to be constructed of 8-in. thick timber and fastened with 1-in. iron (JPSL 1883). With the severe deterioration on the underside of this feature, these timbers may have originally been 8 in. thick. The fasteners also may have originally been 1 in. diameter. Furthermore, the centercase would have been entirely edge-fastened, which CP-022 clearly displays (Barkhausen 1990:11–12). This feature can be distinguished from the centerboard itself, which would have been more heavily fastened. Therefore, feature CP-022 is most likely a portion of the centercase, or centerboard trunk, of *Dora Bluhm*.

Feature CP-019 is an oddly shaped fragment that exhibits characteristics that are clearly from a large, wooden vessel (Figure 4.59–4.60). The feature is sizable and contains 47 iron fasteners,

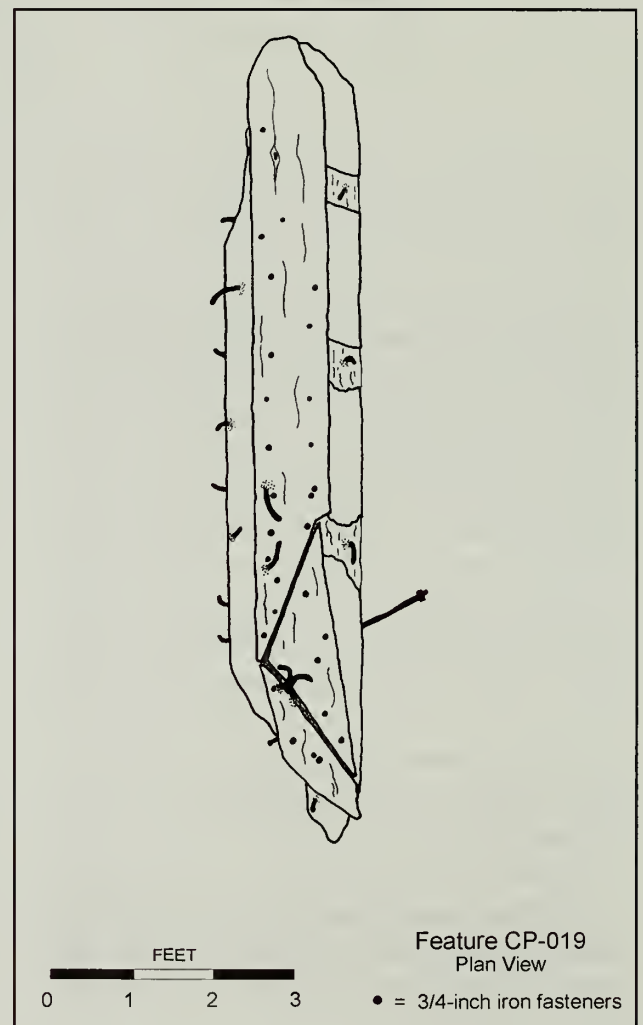
all of which are  $\frac{3}{4}$ -in. diameter round drifts. The fragment is composed of two pieces: a large, lower timber with three mortises along one edge, and a top portion made up of three different sections. These segments include a long element joined to a smaller element by a triangular chock. These three sections are fastened to the lower timber by 33 fasteners. The bottom part of the feature is 9 ft. long, 18 in. wide and 12 in. thick. The top timbers are  $10\frac{1}{2}$  in. wide and 3 in. thick. Like most of the other features, both ends are broken, so original length and configuration is unknown.

*Dora Bluhm's* contract does not go into sufficient detail to identify this feature based on the size of fasteners alone. This is clearly a unique piece, however, and could not have been incorporated into very many places on a sailing vessel. In addition, its size and number of fasteners denote a major structural function. The mortises suggest beams were fitted into the side of the timber, making that piece a deck shelf.



**Figure 4.58.** Fragment of the centerboard trunk (feature CP-022). Drawing by Matt Russell.

**Figure 4.59.** Feature CP-019. Drawing by Matt Russell.







**Figure 4.60.** Feature CP-019. NPS photo by Matt Russell.

The mortises are too small to have received main-deck beams, which would have been much larger. In addition, if this fragment is a main-deck shelf, then it would have been fastened to the frames using much larger fasteners than the  $\frac{3}{4}$ -in. diameter fasteners present. The chock and the angle of the smaller fragment indicate this piece was at one time part of a curved portion of a vessel.

Attributes suggest this fragment is part of the deck clamp or shelf and planksheer for the poop deck of a large, wooden vessel. In the stern, surrounding the poop deck, is an area known as the solid work. In the forward part of the poop, just aft the break of the poop, frames are carried all the way up to the poop deck. This configuration ends further aft, however, and instead, the upper ends of the stern frames end at the knuckle line. Above these frame ends is the solid work, which consists of thick horizontal beams carried around the stern of the vessel. The outer strakes are fastened directly to the solid work as there are no frames in this area. This accounts for the smaller fasteners used on the outside edge of feature CP-019. The beam

ends for the poop deck would have been laid into the mortises on the inside edge of CP-019, and the plank sheer, or cover board, would have laid over the beam ends. This fragment likely represents a portion of the vessel's port side, because of the curve exhibited by the end of CP-019. Because these pieces are not discussed in *Dora Bluhm's* contract, it is impossible to verify this interpretation using scantling or fastener sizes. It was also impossible to examine this area on *C. A. Thayer*.

The last structural member discussed is feature CP-020 (Figure 4.61–4.62). It is a relatively flat fragment with a uniform thickness of  $8\frac{1}{2}$  in. The main timber is 7 ft. 3 in. long (though broken at the ends) and 1 ft. 9 in. wide; a smaller 4-ft. x 1-ft. 4-in. fragment is fastened to it at an angle. The feature contains nineteen  $\frac{3}{8}$ -in. square spikes and seventeen  $\frac{7}{8}$ -in. diameter drifts. Timber and fastener configuration suggest this piece represents a portion of the “rim” of a large, wooden vessel, while the smaller fragment attached to it is a component known as the anchor stock (Curtis 1919: 66). The rim circled the stern of the vessel

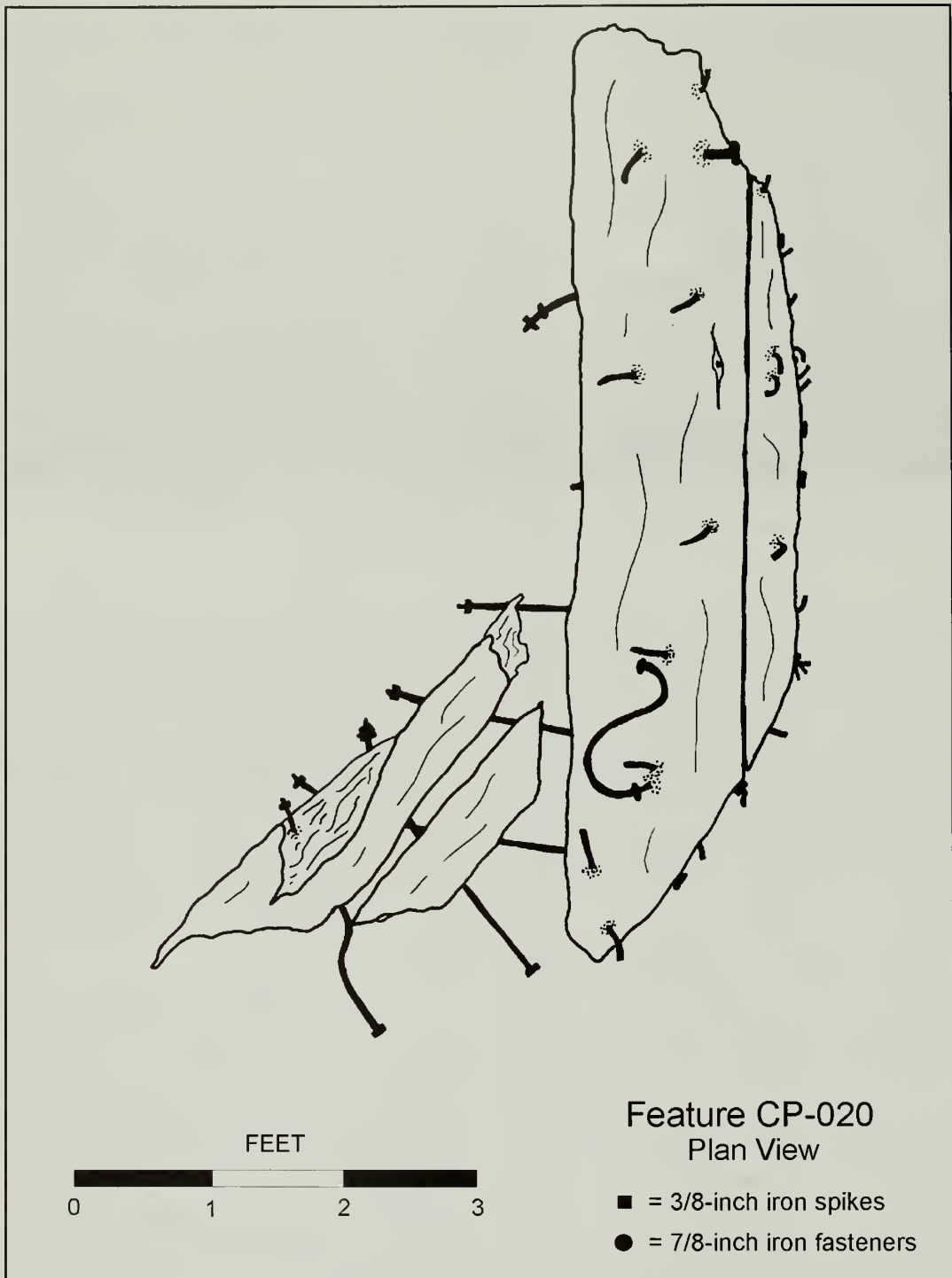
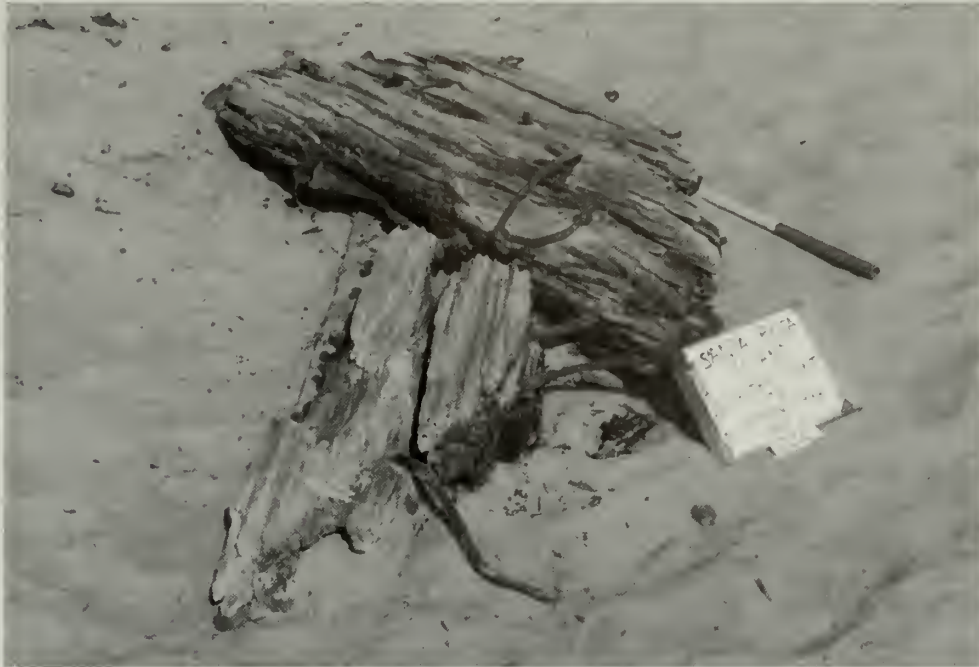


Figure 4.61. Feature CP-020. Drawing by Matt Russell.



**Figure 4.62.** Feature CP-020. NPS photo by Matt Russell.

and formed the knuckle line, or main-deck line. The rim was generally composed of three sections joined by two chocks called anchor stocks. The upper ends of the stern frames ended at the bottom of the rim, and the solid work was directly above it. It was a major stern structural element.

As mentioned above, the 11 remaining features recorded are not structural members from *Dora Bluhm*. The timber size coupled with number and size of fasteners makes association unlikely. It is possible, however, that they are nonstructural fragments from a vessel of the size and age of *Dora Bluhm*. The final items discussed at the Cluster Point site are 15 loose fasteners. No fastener was directly associated with any timber, so little can be speculated about them. Their sizes and length, however, suggest association with a large, wooden vessel of *Dora Bluhm*'s size.

As with the Northwest Cove site, the Cluster Point site includes several elements and

fragments that are likely associated with the Hall-built schooner. These include portions of the keelsons, centerboard trunk, deck planking and upper deck stern structure. Many features recorded at this site could not be identified, and determining their association with *Dora Bluhm* remains inconclusive.

### COMET SITE

Very little of *Comet* was observed during 1993 fieldwork. The 1984 photographs and the terrestrial magnetometer survey conducted during the 1993 study suggested extensive hull remains were buried. The magnetic survey showed a very active magnetic zone in the entire survey area. The region just east of the anchor is relatively quiet. The anchor shows up as a very large anomaly, greater than 2,000 gammas (nanoteslas). Adjacent to the anchor to the north is a distinct, several-hundred-gamma anomaly. The area northwest showed a series of large

anomalies extending throughout the rest of the survey area. Although it was impossible to determine exactly what caused the anomalies, the contour map represents a highly concentrated area of magnetic intensity around the anchor. Anomalies surrounding the anchor indicate that structure appearing in the 1984 photographs was still extant.

### ANCHOR ANALYSIS

Although 1993 fieldwork exposed little of *Comet's* remains, it was possible to completely expose and record the anchor. *Comet's* anchor is iron with a collapsible iron stock (Figures 4.63–4.65). The anchor is fitted with a ring, but no cable is present. Overall length is 7 ft. 11 in.; stock length is 7 ft. 9½ in. Anchor arms are 3 ft. long, with 5 ft. 6 in. between palm tips. The palms measure 1 ft. 3¾ in. wide x 1 ft. 6 in. long, and 1¼ in. thick.

Contemporary late-nineteenth century and early-twentieth century vessels carried a variety of anchors. Classification rules required most ocean-going vessels carry at least three, usually four, anchors, including two bowers, a stream and a kedge (Desmond 1919[1984]:156). The bower anchors were the largest and most important anchors aboard a vessel. They were “lowered from the bow, hence their name . . .” and were kept rigged and ready for deployment at all times (Paasch 1890:150). The stream and kedge anchors were smaller (stream about one-third the weight of the bower, and the kedge about one-half the weight of the stream) and often broken-down and stowed below-decks until needed. These smaller anchors were used for such things as moving the vessel around (kedging), temporary anchoring and as a stern anchor to keep the vessel from swinging in a tide (Paasch 1890:151).

Classification rules stipulated anchor-type's size (weight) based on a vessel's registered

tonnage (Paasch 1890:151). Calculating an anchor's weight can determine what role it played on a vessel. The *Cyclopaedia of Useful Arts* (1854) provides a formula for estimating anchor weight (in hundredweights [cwt] = 110 pounds):  $cwt = \text{overall length}^3 \times .0114$  (Murphy 1993:288). Using this formula, *Comet's* anchor weighs approximately 5.6 cwt or 616 lbs. A table of minimum anchor weights for sailing vessels found in Desmond (1919[1984]) shows a 400-ton vessel (*Comet* registered 429 gross and 368 net tons) was required to carry two 1,850-lb. bower anchors, a 600-lb. stream anchor and a 300-lb. kedge anchor. The anchor found on *Comet* most likely represents its stream anchor.

*Comet's* original contract states the vessel was equipped with one 1,800-lb. anchor, one 1,550-lb. anchor, and one 400-lb. kedge. No mention is made of a stream anchor. It is quite likely, however, that the vessel changed or replaced anchors during its 24-year career.

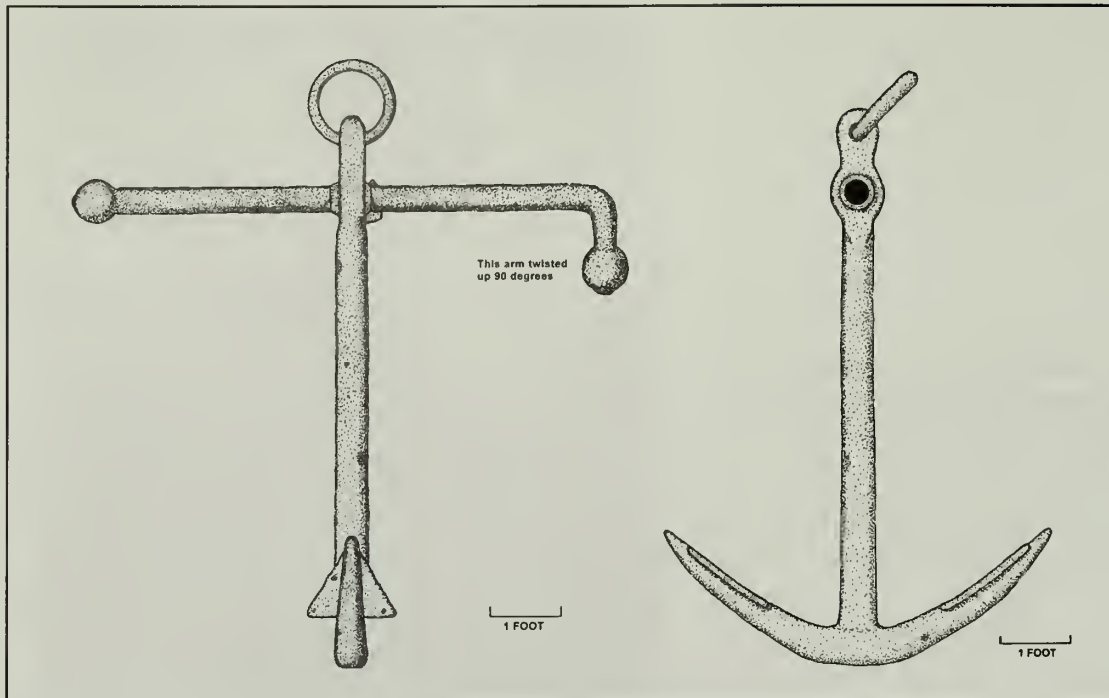
If this anchor represents *Comet's* stream anchor, then a number of questions are raised. Murphy (1993:288) states that, because vessels carried at least four anchors, “multiple anchors are expected on wreck sites.” In addition, “if a ship were in distress, the bower and other anchors might be deployed and perhaps lost; smaller anchors would, consequently, be more likely to be found near the structure of a shipwreck” (Murphy 1993:288).

In *Comet's* case, however, anchors were probably not deployed during the wreck event. After the schooner struck Wilson Rock, it was intentionally grounded in Simonton Cove, so unless anchors were deployed when the vessel initially struck, it is not likely they were dropped to keep the schooner from going ashore on San Miguel Island. Also, *Comet's* wreck report notes that the only action taken to avoid casualty was that the vessel “lowered the sails to ease the strain” (National Archives, Washington

**Figure 4.63.** *Comet's* anchor after exposure in 1993. NPS photo by Matt Russell.



**Figure 4.64.** *Comet's* anchor ring. NPS photo by Matt Russell.



**Figure 4.65.** *Comet's* anchor. Drawing by Matt Russell.

D.C.[NA], Record Group 36 [RG 36], Records of the US Life-Saving Service, Wreck Report 221, 1911). No mention is made of deploying anchors. The most likely scenario, then, is that *Comet's* other anchors were either removed during salvage operations in the months following the wreck event, or are still buried elsewhere in Simonton Cove.

Besides documenting *Comet's* anchor, 1993 fieldwork confirmed extensive remains were likely present beneath the sand and established that site documentation could only take place after winter storms removed overlying beach sand. This finally occurred in March 1999.

### SITE DESCRIPTION

*Comet's* hull remains consist of the vessel's remarkably intact bow section, from just aft of the forecastle-deck-break forward. The site is compact, entirely encompassed within an area

approximately 10 m x 8 m. The nearly intact bow section points out to sea on a heading of 317° magnetic, and the bow is heeled 55° to starboard and tilted down 20°. Much of the bow's port side has been worn away by natural deterioration (Figures 4.66–4.69).

Nearly all *Comet's* original bow structure and related features are represented on the site (Figure 4.70). Exposed structural elements include port-bow framing and outer-hull planking; the partially intact forecastle deck and forecastle-deck beams; the partially intact main deck and main-deck beams below the forecastle deck; the pawl post (sometimes called a pawl bitt or Samson post) extending through the main deck and broken off at the forecastle-deck level; the bowsprit, extending from where it is stepped into the pawl post's forward face to about 19 ft. forward of the bow; the forecastle- and main-deck deck-hooks and waterway hooks; and several bow pointers. Other features present



**Figure 4.66.** *Comet's* bow section looking down at forecastle deck. NPS photo by Matt Russell.



**Figure 4.67.** *Comet* site in April 1999, looking at the port side outer hull timbers. NPS photo by Matt Russell.



**Figure 4.68.** *Comet* site in 1999, looking towards the windlass (mounted on the main deck) in the center of the photo, with the capstan (mounted on the forecastle deck) to the right. NPS photo by Don Morris.



**Figure 4.69.** *Comet* site in April 1999, looking straight towards the bow, which is canted to the left in this photo. The forecastle deck is to the left, port side outer hull planking to the right and the bowsprit is in the bottom of the photo. NPS photo by Matt Russell.



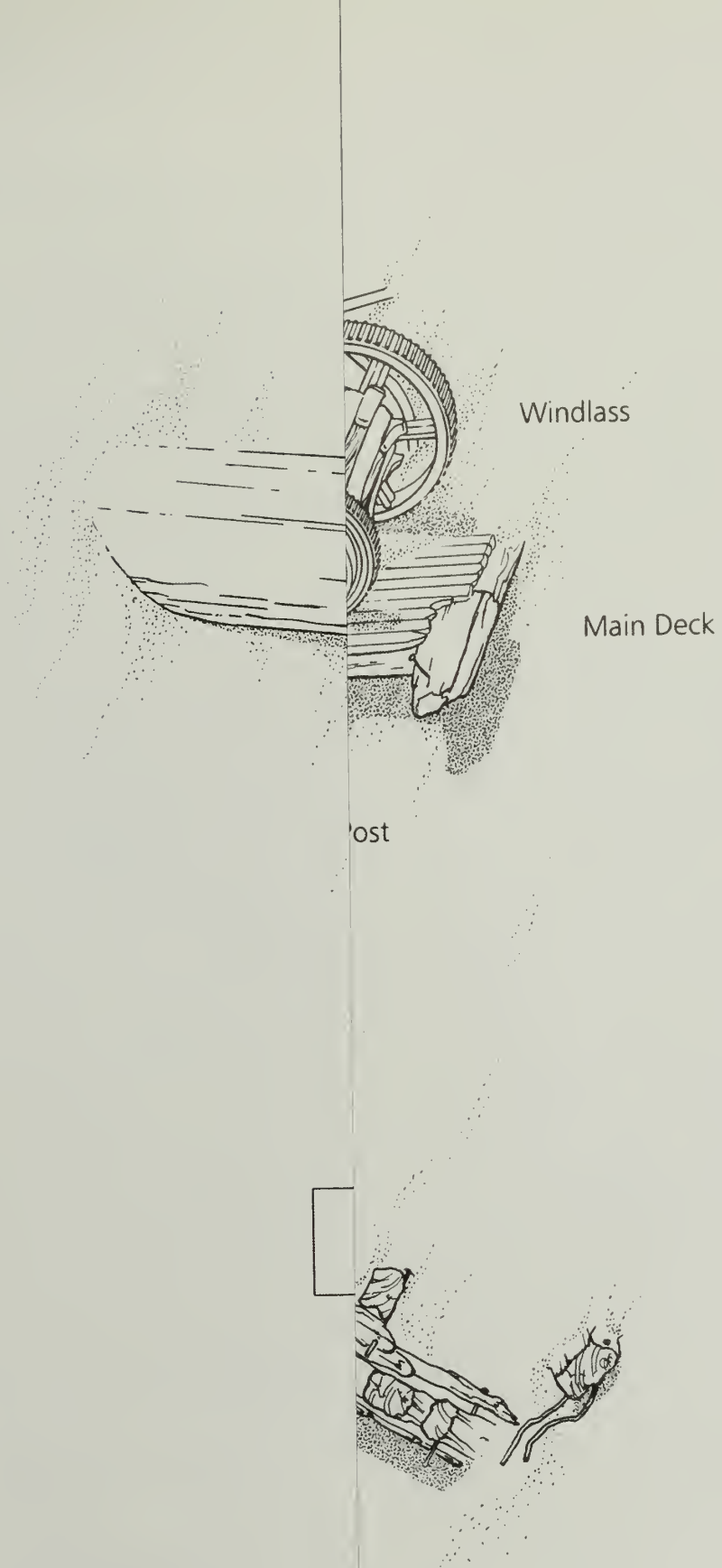


Figure 4.70. *Comet* site plan. Field drawing

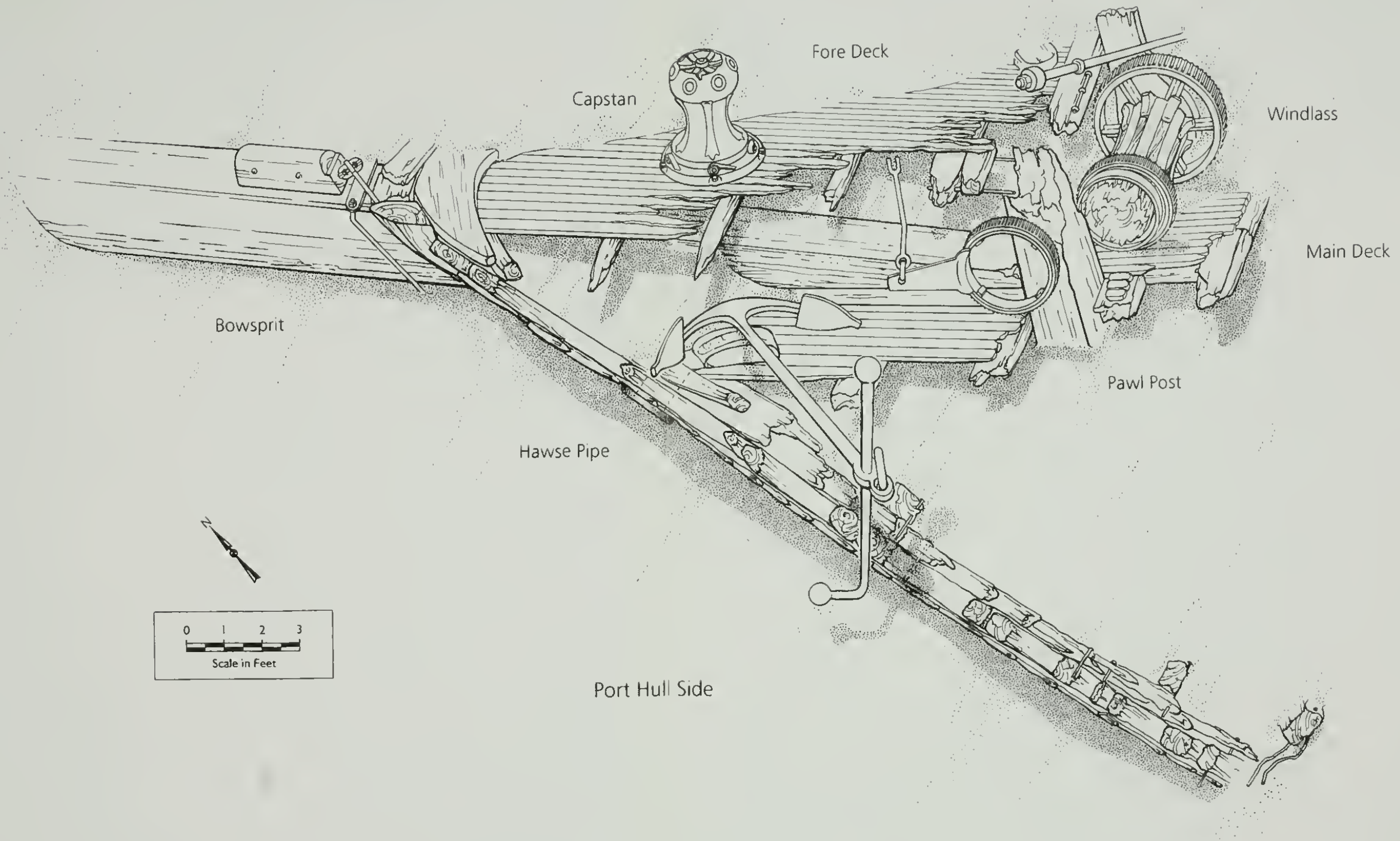


Figure 4.70. Comet site plan. Field drawing by Matt Russell; final drawing by Robert Turner.

are bow rigging elements and ground tackle features including an anchor; the capstan mounted in its original location on the forecastle deck; the intact log windlass' starboard half, still mounted in its original location on the main deck, along with the iron parts of the windlass' port half; the port bow stopper or riding chock; and the port hawse pipe. Although more of the wreck is exposed than the 1984 photographs show, much of the starboard bow still lies deeply buried in the sand and was not documented.

### SITE ANALYSIS

Analysis of *Comet's* bow remains logically falls into three categories: wooden bow structure; bow rigging components; and ground tackle elements. Each category is discussed separately. Comparisons are made to *Comet's* original construction contract and the American Shipmasters' Association *Rules for the Construction of Wooden Vessels* published in the *Record of American and Foreign Shipping* (1879) to see if actual construction varied from planned construction. Comparing classification rules for wooden ship construction and the original construction contract to *Comet's* remains can aid determination of whether actual construction followed published standards and written agreements, or if cost-cutting shortcuts were taken. Both natural and cultural site-formation processes have significantly affected the site. With only *Comet's* bow remaining, it is obvious that significant natural and cultural forces worked to remove the remainder of the vessel, and these processes are discussed below.

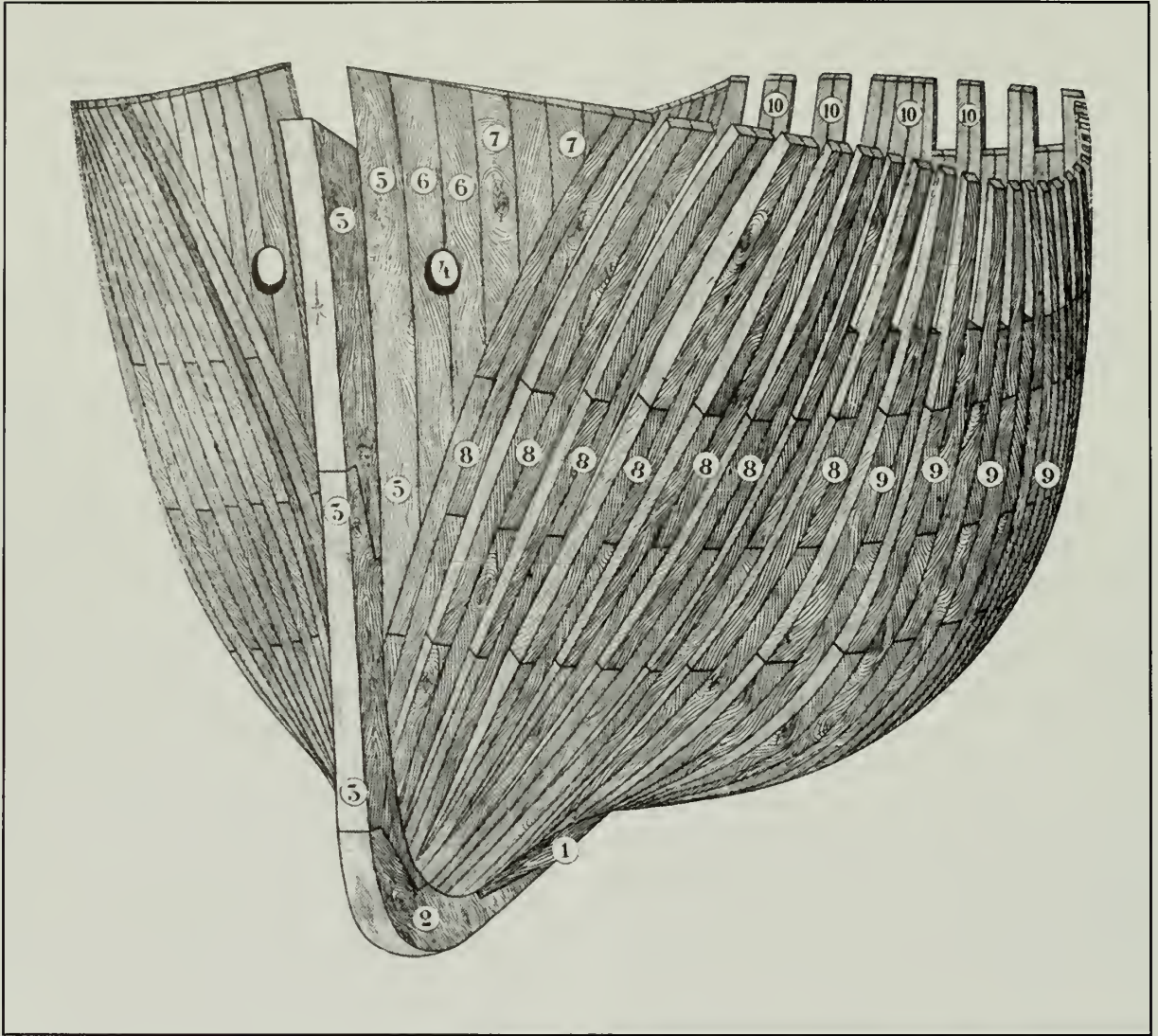
### BOW STRUCTURE

*Comet's* exposed bow structure includes most principal components used in wooden sailing vessel bow construction. Because the wreck is heeled over to starboard, the starboard

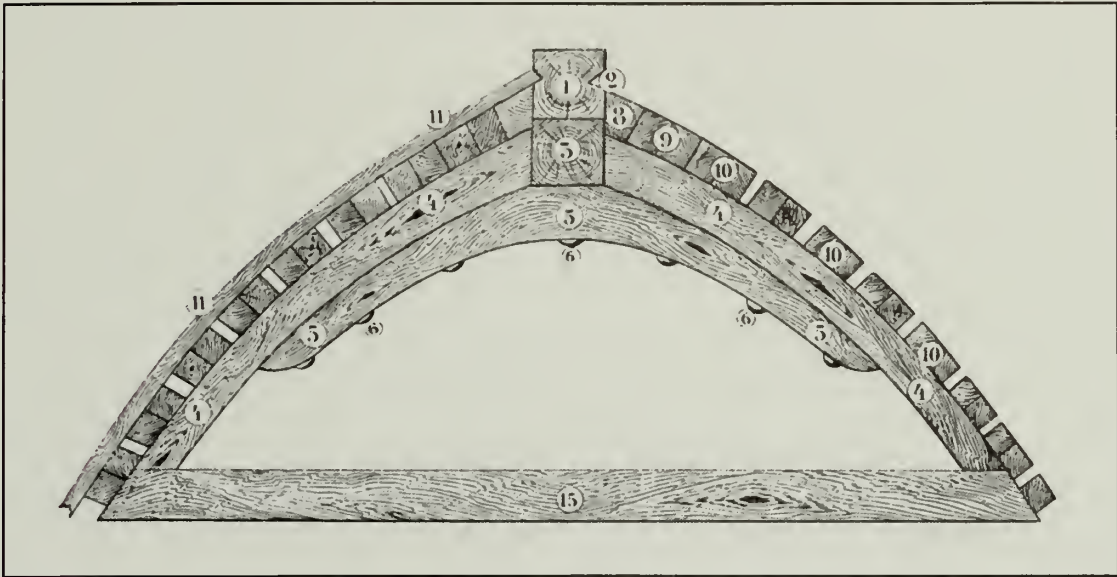
side remained deeply buried in the sand and only the port side was accessible for documentation. Port-side hull remains include five, possibly six, frame pairs, two hawse timbers, and the port knighthead, along with outer hull planking and interior ceiling planking. The stempost was not observed during documentation because it was buried in the sand beneath the bowsprit. Interior hull features such as pointers, hooks, clamps and decks are also present, as well as the bowsprit and pawl post.

Bow framing in a wooden vessel of this period includes cant frames, hawse timbers, knightheads, and the stempost (Figures 4.71–4.73). Cant frames are frame pairs, made up of futtocks and top timbers (futtock heels are notched into the bow deadwood, so there are no floors) that are rotated forward of perpendicular to the keel to create the vessel's bow form. Forward of the cant frames are hawse timbers, which solidly fill the space between the cant frames and knightheads. A vessel's hawse pipes pass through the hawse timbers, which provide a solid foundation for fastening the hawse pipe flanges. The knightheads are timbers located on both sides of the stempost and extend above it to support the bowsprit, which rests atop the stempost and between the knighthead timbers (Desmond 1919[1984]:50, 55).

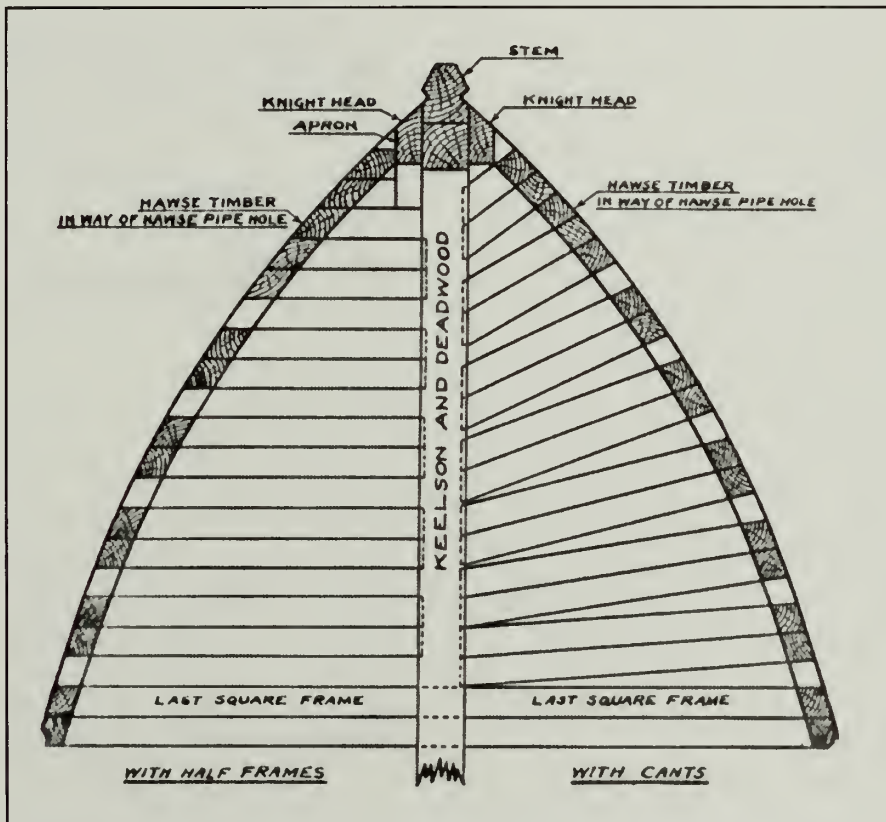
Although it was difficult to verify because of limited access and complex angles involved, the five frame pairs are most likely all cant frames as opposed to half frames (Figure 4.74 and see Figure 4.73). At their greatest exposed dimension, each frame measured 9½ in. sided and 10 in. molded. Each frame's molded dimension at the top, approximate main-deck level, was 8 in. *Comet's* contract specifies frames as sided 10 in. and molded 13 in. at the keel and 6½ in. at the deck (JPSL 1886). *Rules for the Construction of Wooden Vessels* stipulates a 400-ton vessel built of "yellow fir" should have top timbers (frames at deck-level)



**Figure 4.71.** Bow framing, including sternpost (3), knighthead (5), hawse timbers (6) and cant frames (8) (from Paasch 1977:plate 5).



**Figure 4.72.** Bow framing, including stempost (1), knighthead (8), hawse timbers (9) and cant frames (10). Additional features observed on *Comet* include the deck hook (5), deck beams (15) and outer hull planking (11) (from Paasch 1997:plate 15).



**Figure 4.73.** Bow framing, showing difference between cant frames and half frames (Curtis 1919:58).



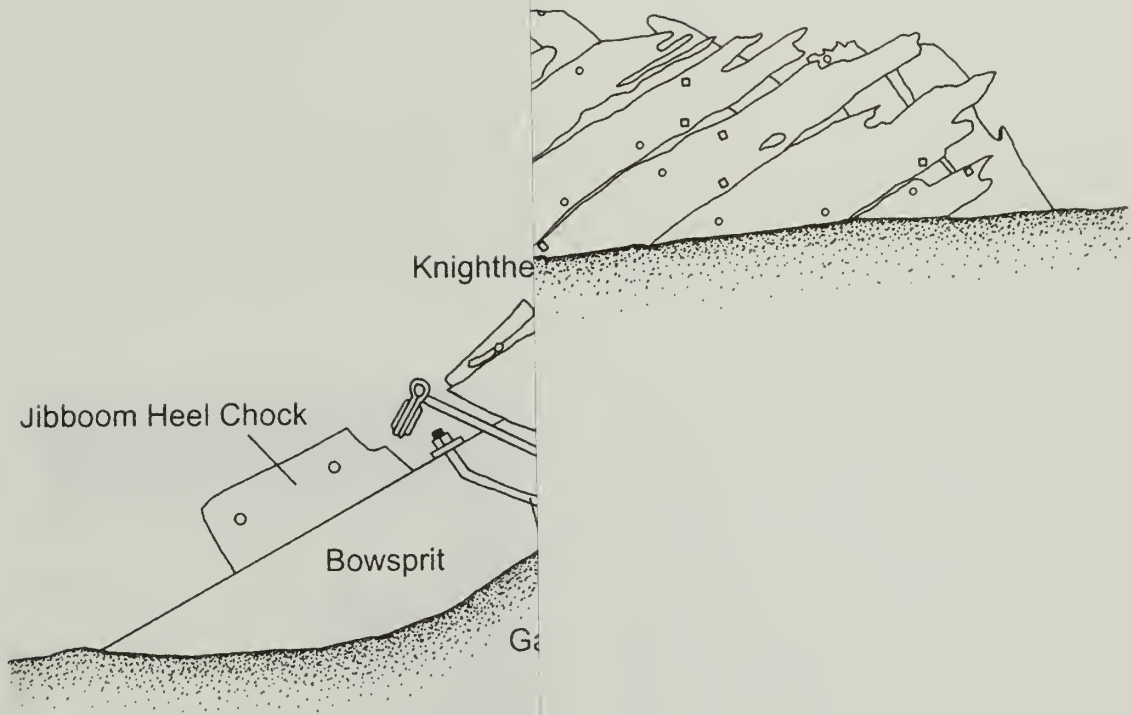
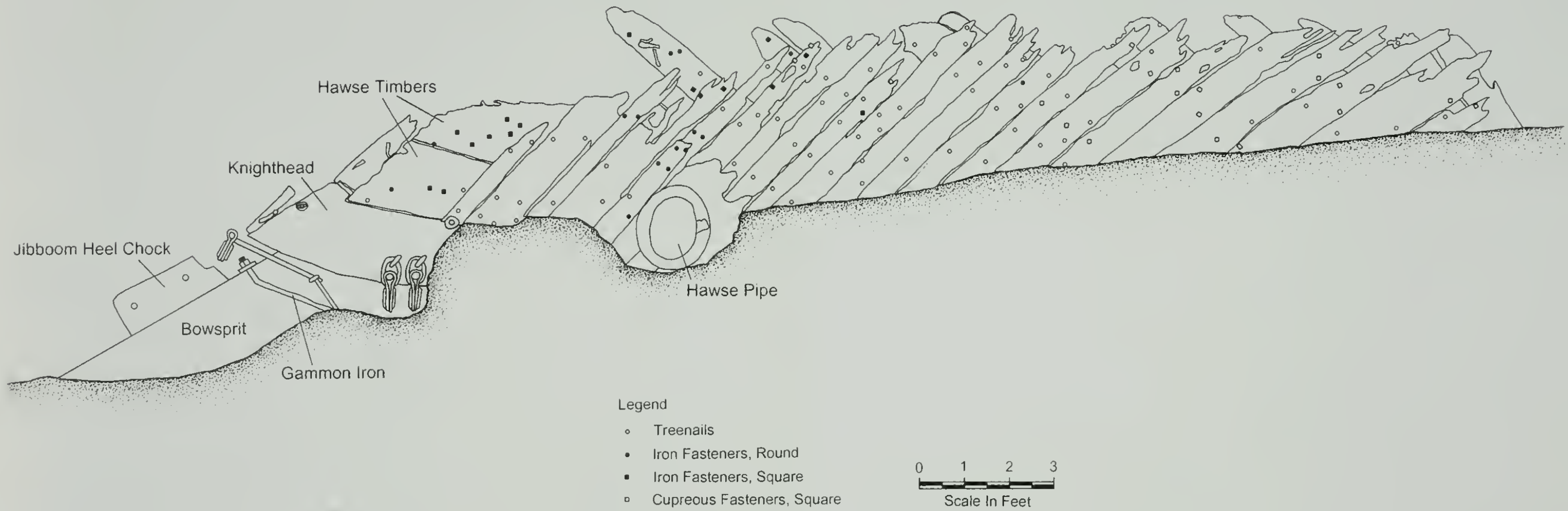


Figure 4.74. Comet port elevation drawing



**Figure 4.74.** *Comet* port elevation drawing. Drawing by Jim Bradford; inked by Nancy Lamm.



sided 8 in. and molded 7½ in. (American Shipmasters' Association 1879:xxviii). Taking into account timber erosion from natural weathering, *Comet's* cant frames' sided dimension matches that specified in the contract and exceeds that given in the rules; molded dimensions exceed both the contract and rules, but this is possibly only true for the cant frames, because no square frames were present to be examined. Individual frames making up each frame pair were fastened together with trenails measuring between 1¼ and 1½ in. in diameter. A combination of trenails and iron drift pins fasten the outer hull planking, frames and ceiling planking together. Forward of the forward-most frame pair is what appears to be a single frame, but it is likely its adjacent frame member is broken below the sand line and could not be

observed. This makes a total of six frame pairs represented on site.

Forward of the frame pairs are two hawse timbers, or hawse pieces (Figure 4.75; see Figure 4.74). These timbers “. . . close the openings between forward cant frames from the knightheads aft as far as necessary to give good solid fastening for hawse-pipe flanges. The lower ends of hawse timbers are bolted to the apron and the several hawse timbers are edge-bolted together . . .” (Desmond 1919[1984]:55). The hawse pieces are 6 in. molded and 2 ft. sided, though their sided dimension appears to narrow over their length, and the aft hawse piece is eroded on its aft side, making an accurate original sided dimension difficult to measure. The top edge of the hawse pipe is located 5 ft. 5 in. below the upper surface of the hawse timbers.



**Figure 4.75.** *Comet's* bow. The hawse timbers are in the center with the white float on them. The hawse pipe is visible at the sand-line, to the right of the hawse timbers. In the right foreground is an unattached rigging element. NPS photo by Matt Russell.

Forward of the hawse timbers is the port-side knighthead (Figures 4.76 and 4.77; see Figure 4.74). The knightheads strengthen the bowsprit and support the hooding ends, which are the forward ends of the outer hull planks (Desmond 1919[1984]:50). The knighthead is rhomboid in shape, with each side varying slightly between 1 ft. 2 in. and 1 ft. 3 in., and its shape narrows and curves over its length. Neither hawse timbers nor knightheads are mentioned in *Comet's* contract, but the *Rules for the Construction of Wooden Vessels* states that knightheads and hawse timbers should have double the sided dimension of the frames (American Shipmasters' Association 1879:xxi). *Comet's* hawse timbers are sided more than double the frames' sided dimensions, and the port knighthead, if measured on the diagonal, also follows this specification. The starboard knighthead and stempost were buried in the sand beneath the bowsprit and neither was observed.

A total of 21 outer hull planks were recorded, varying in width from 5 in. to 1 ft. 2 in. and from 1 to 2 in. thick (Figure 4.74). *Comet's* contract states planking should be 4 in. thick, while *Rules for the Construction of Wooden Vessels* specifies it should be 3½ in. thick (JPSL 1886; American Shipmasters' Association 1879:xxviii). Erosion likely accounts for the difference between *Comet's* outer hull planking thickness and the thickness recorded in historical documents. Outer hull planks were fastened to the frames with a combination of treenails, round iron fasteners, and square iron and cupreous spikes, which conforms to outboard fastenings specified in the contract (JPSL 1886). Two strakes overlay the outer hull planking directly above the hawse pipe, creating a double layer of planking. This feature is undocumented in contemporary historical records, and how common a construction practice this was in Pacific Coast lumber schooner shipbuilding is unknown. The ends of eight ceiling planks were

exposed on *Comet's* interior, varying between 6 and 8 in. thick, and attached to the frames with both round iron fasteners and wooden treenails. *Comet's* contract states that the ceiling from the turn of the bilge to the clamps should be 8 in. thick (JPSL 1886), which matches on-site measurements, taking into account timber erosion. This far exceeds the 4½ in. thick ceiling specified by *Rules for the Construction of Wooden Vessels* (American Shipmasters' Association 1879:xxviii), however, thickened ceiling planking was commonly used in lumber schooners to increase longitudinal strength, which was necessary in a single-decked vessel (MacGregor 1982:63).

Both the main deck and forecastle deck are intact and in place from the centerline starboard, though almost the entire port half of each deck has deteriorated due to natural erosion (Figure 4.78). Four main-deck beams are visible supporting remnants of the main deck. Exposed ends of each deck beam are eroded, but dimensions vary from 10 to 13 in. wide and 7 to 9 in. thick, indicating the deck beams were originally at least 1 ft. 1 in. wide x 9 in. thick. Deck beams are specified in *Comet's* contract as being sided 14 in. and molded 11 in. (JPSL 1886), which matches reasonably, taking into account timber erosion. This again exceeds the 10½ in.-sided dimension specified in *Rules for the Construction of Wooden Vessels* (American Shipmasters' Association 1879:xxviii). Although not noted in the literature, possibly larger deck beams were used because of the large deckloads lumber schooners were required to carry. Thickening deck beams would have increased ship construction costs minimally, but returns on this small investment would have accrued throughout the vessel's operational life. Two deck beams are located directly fore and aft of the pawl post, a third is located 1 ft. 4½ in. aft of the beam butting the pawl post's aft face, and the fourth is located 2 ft. 10¾ in. forward of the

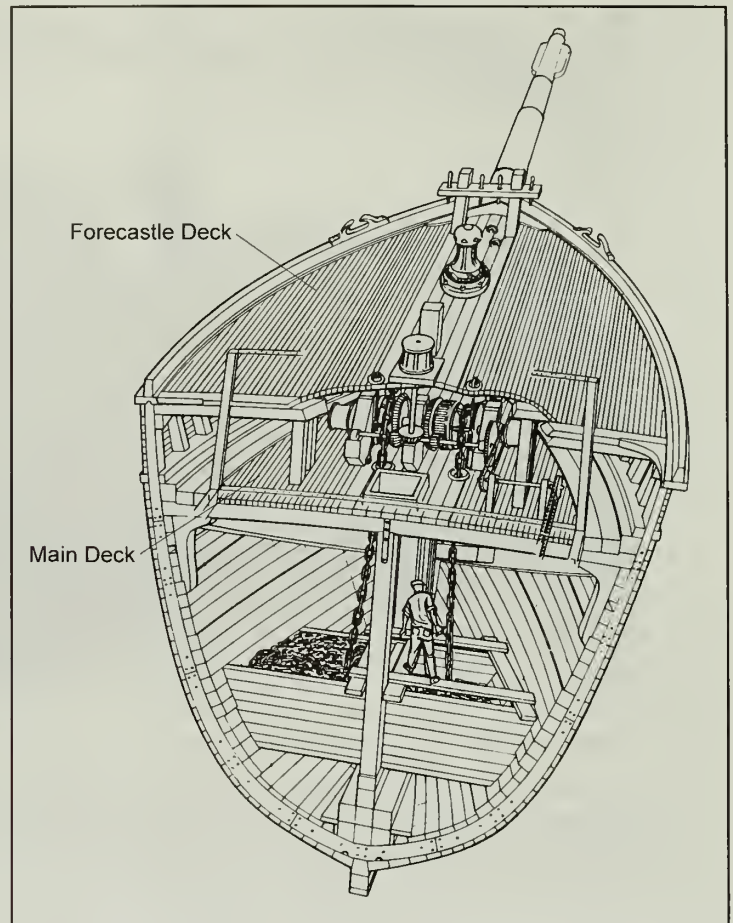


**Figure 4.76.** The port knighthead is the large timber on the right side of the photograph. The bowsprit extends horizontally to the left in the photo with the jibboom heel chock on top; also visible are the gammon iron and a single bull's-eye that held the foremast stay.



**Figure 4.77.** Top view of *Comet's* knighthead (to the lower right of the white float), bowsprit and jibboom heel chock. NPS photo by Matt Russell.

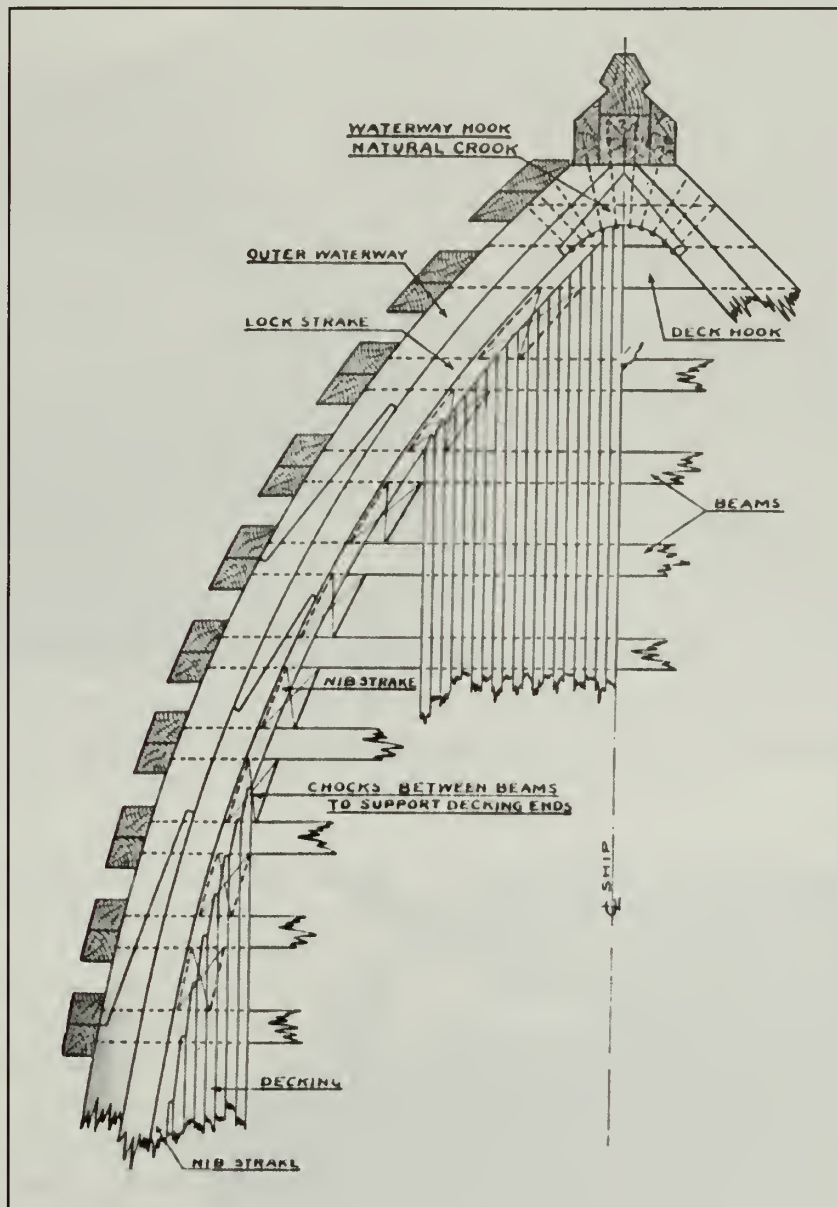
**Figure 4.78.** Bow section of a wooden-hulled schooner showing main deck, forecastle deck and location of windlass (from Greenhill and Manning 1995:90).



beam butting the pawl post's forward face. It is unknown if the latter beam is the forward-most beam or if there are more between it and the bow. Deck clamps (supporting structure for beam-ends) are not present on the port side. Twenty main-deck planks are visible: 12 starboard of the bowsprit and 8 to port. Deck planks are 3½ in. sided x 3 in. molded with a ¼-in. caulk-line between each at the surface. Deck planking is specified in the contract as 4 in. x 4 in., and in *Rules for the Construction of Wooden Vessels* as 3½ in. molded (JPSL 1886; American Shipmasters' Association 1879:xxviii). These figures are all reasonably close, and erosion could account for observed on-site differences. Each deck plank is fastened to each deck beam with two iron spikes. Main-deck spikes are 6 1/8

in. long with 7/16-in. square shanks and 13/16-in., four-faceted heads, and are countersunk and plugged with 1-in. diameter wooden plugs. A main-deck hook and main-deck waterway hook are present in the bow, and the forward ends of the main-deck planks rest on and are fastened to the main-deck hook and butt against the main-deck waterway hook, which follows the typical practice (Figure 4.79)(Curtis 1919:134–135, 144–145). As with the deck clamps, waterway strakes are no longer present.

The starboard side of the forecastle deck is intact from the bow to the deck's aft end above the windlass (Figure 4.80; also Figures 4.66 and 4.69). Forecastle deck remains are supported by five deck beams; the three forward-most beams are 5½ in. sided, and the two aft beams,



**Figure 4.79.** Planking details, showing deck and waterway hooks (from Curtis 1919:146).



**Figure 4.80.** *Comet* site in April 1999, looking down on the forecastle deck with the capstan mounted to it. The bow is to the right. NPS photo by Matt Russell.

fore- and aft- the pawl post, are sided between  $9\frac{1}{2}$  and  $10\frac{1}{2}$  in. Like on the main deck, port clamps are absent. Thirty forecastle-deck planks are exposed; all 3 in. sided x  $2\frac{1}{2}$  in. molded. Each plank is fastened with a single boat spike at its forward end, a single boat spike at its aft end (for complete planks), and a single boat spike in each deck beam. Forecastle-deck spikes are  $5\frac{1}{4}$  in. long with  $5/16$ -in. square shanks and  $11/16$  in., four-faceted heads and are countersunk and plugged with 1-in. diameter wooden plugs. Deck plank forward ends are resting on and fastened to the forecastle-deck hook and are butted against the forecastle-deck waterway hook (Figure 4.77). Again, like the main deck, waterway strakes are gone. Complete deck plank aft ends are resting on and fastened to a recessed shelf notched into the forward edge of the aft-most forecastle-deck beam (Figure 4.81). Forecastle deck beam and

plank dimensions are not specified in either *Comet's* contract or *Rules for the Construction of Wooden Vessels*.

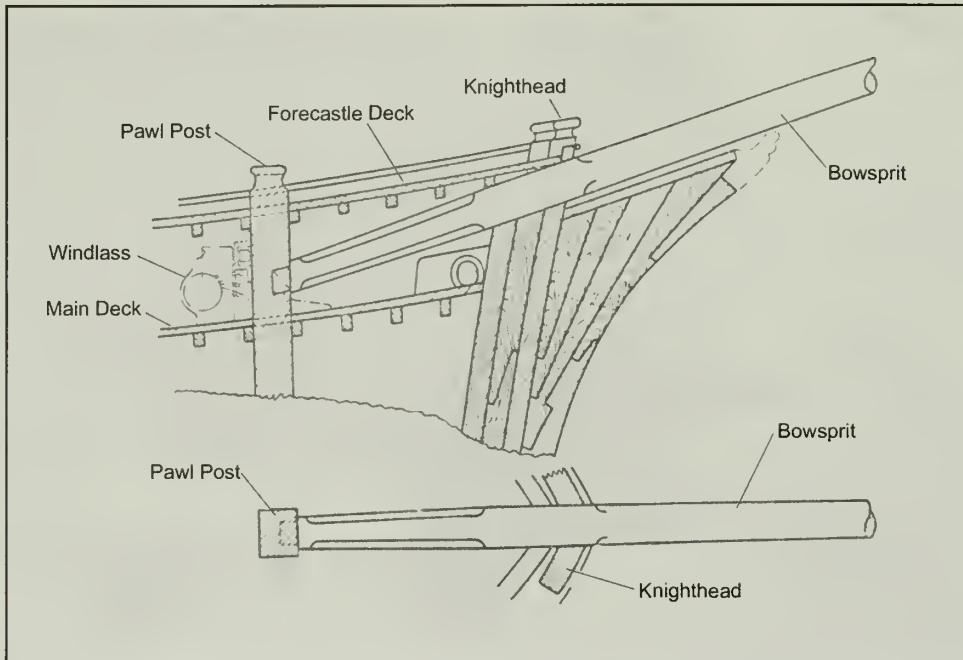
The pawl post, sometimes called the pawl bitt, Samson post or heel bitt when the bowsprit is stepped into it, is present from forecastle-deck level to the main-deck level, where it is buried in the sand (Figures 4.82–4.84). The pawl post is a solid timber, usually stepped into the keelson or bow deadwood, which extends upward and ends above forecastle-deck level (Chapelle 1973:368–370; de Kerchove 1961:91; Underhill 1958:88). In *Comet*, the pawl post served two purposes: 1) the bowsprit's inboard end, called the heel, is stepped into the pawl post's forward face; so the pawl post serves as a major reinforcing member for the bow rigging; and 2) the windlass pawl was mounted on the pawl post's aft face, though neither the windlass pawl nor pawl rim are present on site. The pawl post



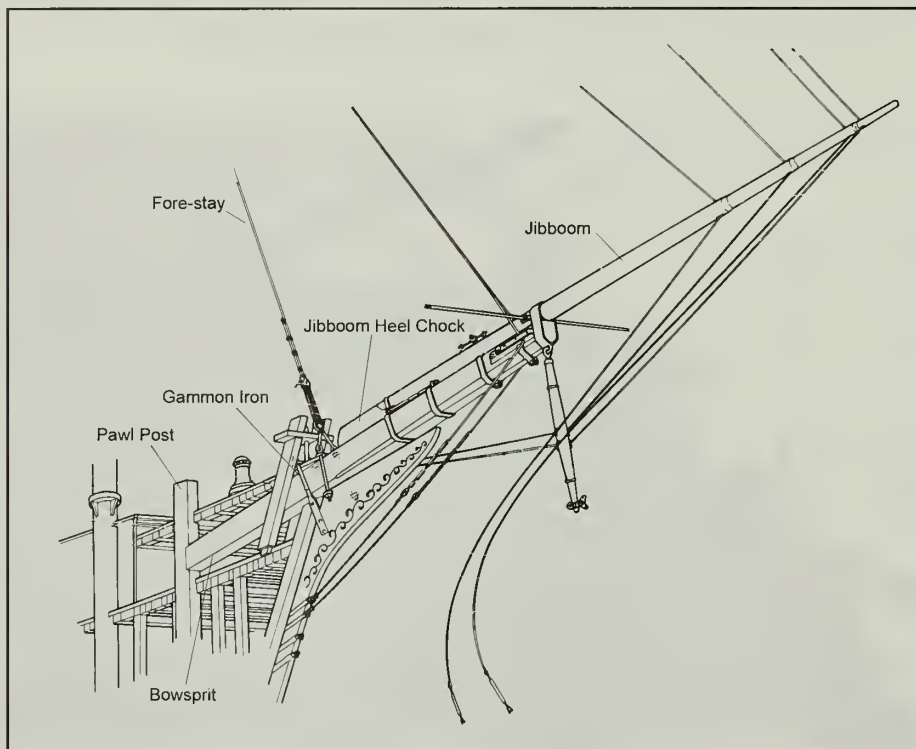
**Figure 4.81.** Top view of the aft end of the forecastle deck. The aft-most forecastle deck beam is the vertical timber in the center of the photo. The windlass is to the left, mounted on the main deck below; the starboard cathead is the angled timber to the right. NPS photo by Matt Russell.



**Figure 4.82.** Photograph taken from the perspective as if the viewer were standing on the main deck looking forward. The pawl post is to the left of the windlass. NPS photo by Matt Russell.



**Figure 4.83.** Schooner bow section showing the bowsprit stepped into the forward face of the pawl post (after Underhill 1958:88).



**Figure 4.84.** Schematic of a schooner bow-section, showing the bowsprit stepped into the pawl post, the jibboom, jibboom heel chock, gammon iron and fore-stay (after Greenhill and Manning 995:113).

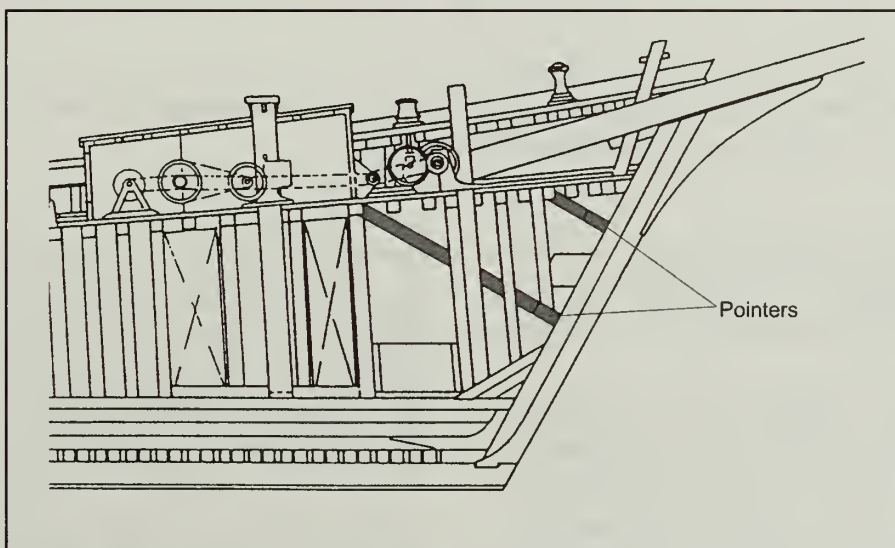


measures 1 ft. 6 in. fore and aft x 1 ft. 7 in. side to side at main-deck level, and 1 ft. 4 in. fore and aft x 1 ft. 6 in. side to side at forecastle-deck level. Approximately 4 ft. of the pawl post was exposed.

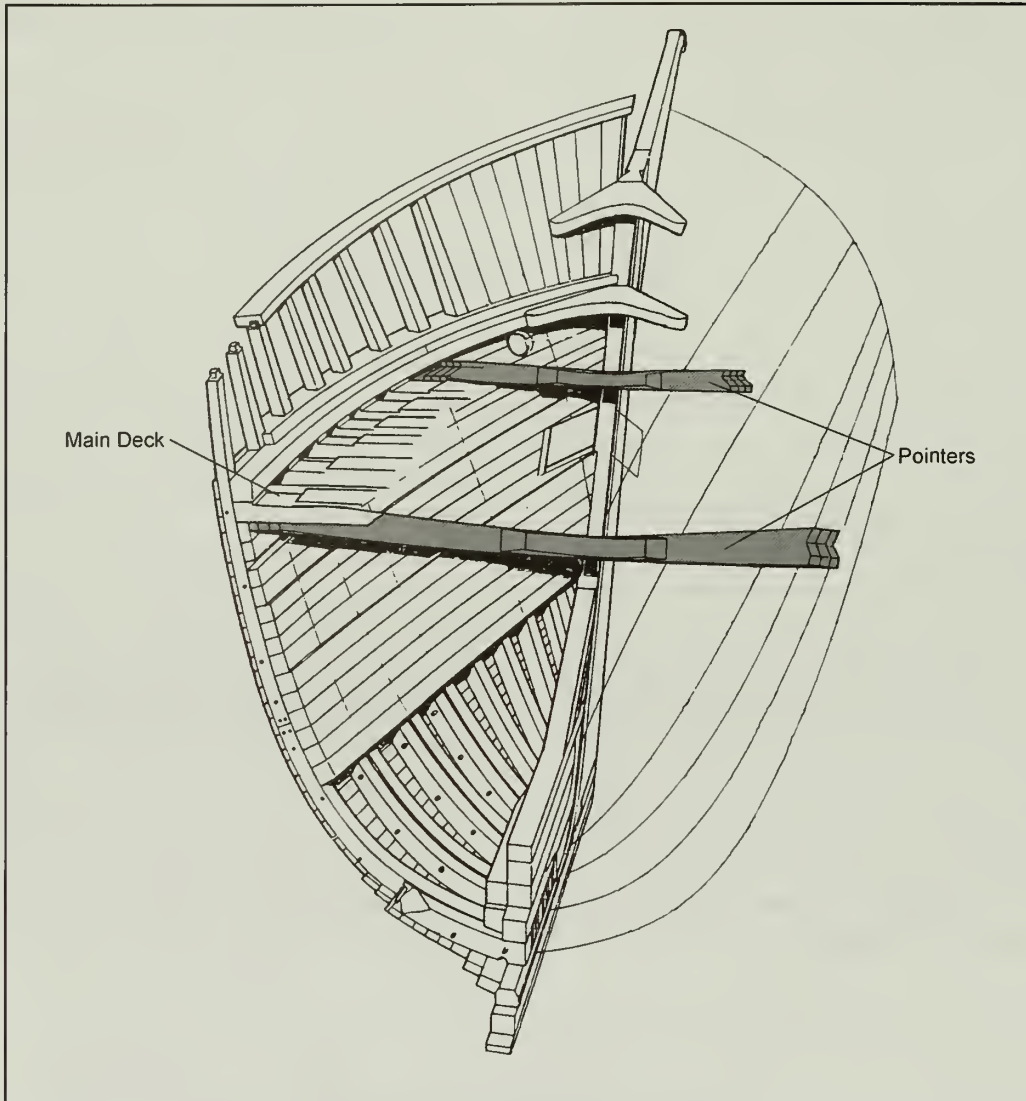
*Comet's* bowsprit is present and appears to be completely intact, though its outboard end, called the head, could not be uncovered. The bowsprit heel is stepped into a 6-in. wide x 10-in. high x 7-in. deep notch in the pawl post's forward face. At the heel, the bowsprit is 10 in. high x 1 ft. 7 in. wide (the width of the pawl post). A filler piece is fitted below the bowsprit heel between the bowsprit and the main deck. This filling timber is 9 in. thick, with an exposed length of 6 ft. 9 in. (its forward end was buried beneath the sand). The forward-most section of the bow, between decks, is buried in the sand, so the point where the bowsprit exits the hull could not be examined, however, the bowsprit presumably passes on top of the stempost and between the knightheads. Forward of the bow, the bowsprit transitions from a square cross-section to a rounded cross-section, and most likely begins to taper (Figures 4.69 and 4.75–

4.77). Just forward of the bow structure, the bowsprit is 2 ft. square.

The final structural members discussed are two timbers in the site's southwest corner, rising vertically out of the sand inside the ceiling planks (Figure 4.70). At the deepest exposure, about 2 ft. of these timbers were visible. The aft-most timber measures 1 ft. 2 in. x 9 in., and has two 7/8-in. diameter iron fasteners in it. The forward-most of these two timbers measures 11 in. x 7 in. These structural timbers are likely pointers, placed in the bow and stern angled down diagonally in their normal upright position (Figures 4.85 and 4.86). According to Curtis (1919:101), pointers are used to “. . . furnish additional stiffening to the hull at the locality where the pointer is placed, to aid in resisting panting movements and stresses, and . . . to add additional strength against torsional strains such as are experienced at the ends of a ship when rolling heavily at sea.” Pointers are fastened at a 45° angle atop the ceiling planks and into the cant frames, and they extend from the lower part of the hull upwards to the first, or in *Comet's* case, main deck (*Great Lakes Register*



**Figure 4.85.** Bow pointers in a wooden-hulled schooner (after Greenhill and Manning 1995:63).



**Figure 4.86.** Schematic showing location of bow pointers in a wooden-hulled schooner (after Greenhill and Manning 1995:70).

1908:183; Curtis 1919:101–102). *Comet's* contract only states: “. . . there shall be breast hooks and pointers forward and aft. . .” (JPSL 1886).

According to the original construction contract, *Comet's* hull was constructed entirely of Douglas (yellow) fir, with the exception of the “outside of stem, rudder [stern] post, bits, (with the exception of pawl bitt) . . . and windlass to be of hardwood” (JPSL 1886). Visual examination of all exposed wooden structural

members verified all were Douglas fir except the carrick bitt and windlass (see below). As noted above, *Comet's* hull was fastened with a combination of iron and cupreous spikes, iron drift pins and wooden treenails. The contract gives specifics for many fastening types and sizes, and it notes that outer hull plank fastenings would include “treenails from turn of bilge to planksheer Locust” (JPSL 1886). Two treenails were sampled for wood identification (Field Samples #03 and 04), both from near the

planksheer (main-deck line), but it was impossible to determine if they were precisely from above or below the planksheer. Field Sample #03 is Douglas fir (*Pseudotsuga menziesii*), while Field Sample #04 is Osage-orange (*Maclura pomifera*) (Puseman and Scott-Cummings 1999:Table 2). Osage-orange is noted to be “hard, heavy, strong, and very durable” (Puseman and Scott-Cummings 1999:2). It is unknown why locust was not used as specified, though perhaps osage-orange was a suitable substitute, although this could not be verified through documentary sources. In addition to fastenings, *Comet*’s contract notes that caulking between the outer hull planks would be “six thread of oakum in garboards and hawsed, from thence to plank sheer four threads and hawsed . . .” (JPSL 1886). Oakum was a common caulking material, made from “strong, pliable tarred rope fibers obtained from scrap rope, which swell when wet . . . Before oakum is used it is worked or spun into threads . . .” (de Kerchove 1961:543). A caulking sample (Field Sample #05) was collected from between outer hull planks, and it was identified as jute (*Corcherus capsularis*), a well-known fiber commonly used for rope (Puseman and Scott-Cummings 1999:2).

### BOW RIGGING

Several major bow rigging elements are present on the *Comet* site, including the bowsprit, the gammon iron, the jibboom heel chock, two bullseyes attached to the port bow, a single bullseye above the bowsprit where it exits the hull and an unattached iron rigging element located off the port bow. Each of these elements was an integral part of *Comet*’s bow rigging support.

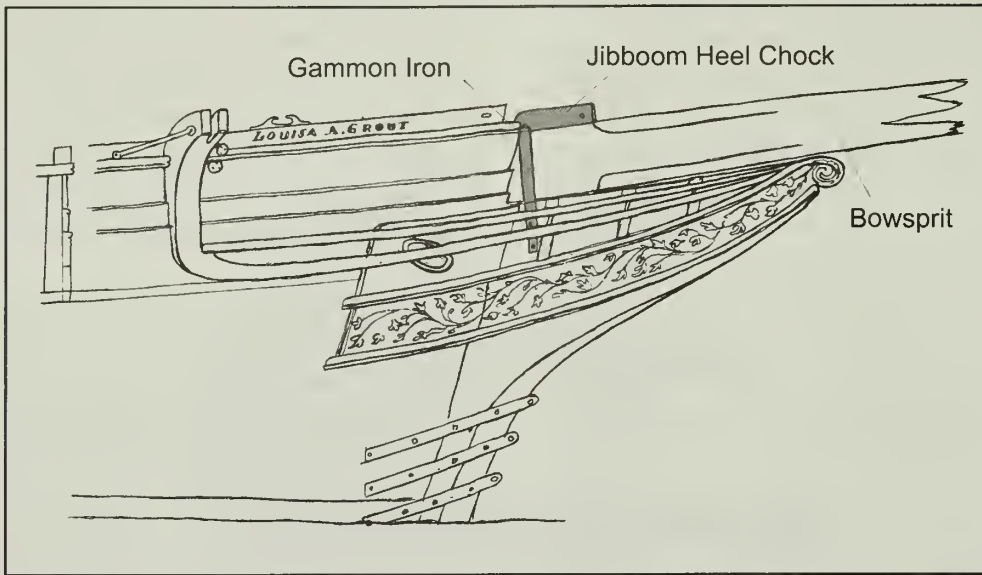
As noted above, *Comet*’s bowsprit is intact and in its original position (Figures 4.69, 4.70 and 4.75–4.77). On a wooden sailing vessel, the bowsprit, a spar that projects forward from

the bow, serves two main purposes: 1) to extend the head sails forward, balancing the sail plan by counteracting the effect of the after sails; and 2) to support the foremast, which is fastened to it with stays (Figure 4.84) (de Kerchove 1961:90). *Comet*’s bowsprit is formed from a single, large timber, most likely Douglas fir.

Just forward of the knighthead, set up around the bowsprit, is the gammoning or gammon iron (Figures 4.76 and 4.77). The gammoning secures the bowsprit to the stempost and counters the upward lift of the foremast stays. Before the late-nineteenth century, gammoning consisted of rope or chain lashed over the bowsprit; later it was replaced by an iron band, which could be tightened with nuts and bolts (de Kerchove 1961:323). Chapelle (1973:479) depicts gammon iron consisting of iron straps for both the horizontal (across the bowsprit’s upper surface) and vertical (down the bowsprit’s sides and bolted to the stempost) components (Figure 4.87; see Figure 4.84). *Comet* has 5-in. wide x 1-in. thick iron strap across the bowsprit’s upper face secured by 1½-in. diameter, round iron bar stock on either side of the bowsprit to the stempost. The top of the bar stock is threaded and tightened to the strap with 2¾-in. hex nuts. The point where the bar stock attaches to the stempost was buried and could not be documented.

Located on the bowsprit’s upper surface, just forward of the gammon iron, is the jibboom heel chock or block, also called the jibboom saddle (Figures 4.76 and 4.77) (Chapelle 1973:359, 368, 503; de Kerchove 1961:408; Underhill 1958:33). This is a small wood block that supported the jibboom heel. The jibboom is a spar located on top of and attached to the bowsprit that extends forward of it (Figures 4.84 and 4.87)(de Kerchove 1961:408).

Attached to the outside face of the port knighthead, above and forward of the hawse pipe, are two bull’s eyes, which are similar to



**Figure 4.87.** Vessel bow section showing location of the gammon iron and jibboom heel chock (after Chapelle 1973:359).

deadeyes used for mast shrouds but with a single large hole in the block instead of three smaller ones. The bull's eye wooden blocks are round, 7 in. in diameter with a 3-in. diameter hole, and  $3\frac{3}{4}$  in. thick. The iron strops around the blocks are  $1\frac{3}{4}$  in. wide,  $\frac{1}{4}$  in. thick and are each attached to the knighthead with an iron ring through an iron eyebolt (Figure 4.76). *C. A. Thayer*, a late-nineteenth century, three-masted lumber schooner preserved at San Francisco Maritime National Historical Park, has identical bull's eyes in the same location that support the bowsprit guys (Figure 4.88) (Underhill 1958:103). Alternatively, these bull's eyes could support bow rigging footropes, jumbo stays or the martingale guys (Chapelle 1973:603; Underhill 1958:250).

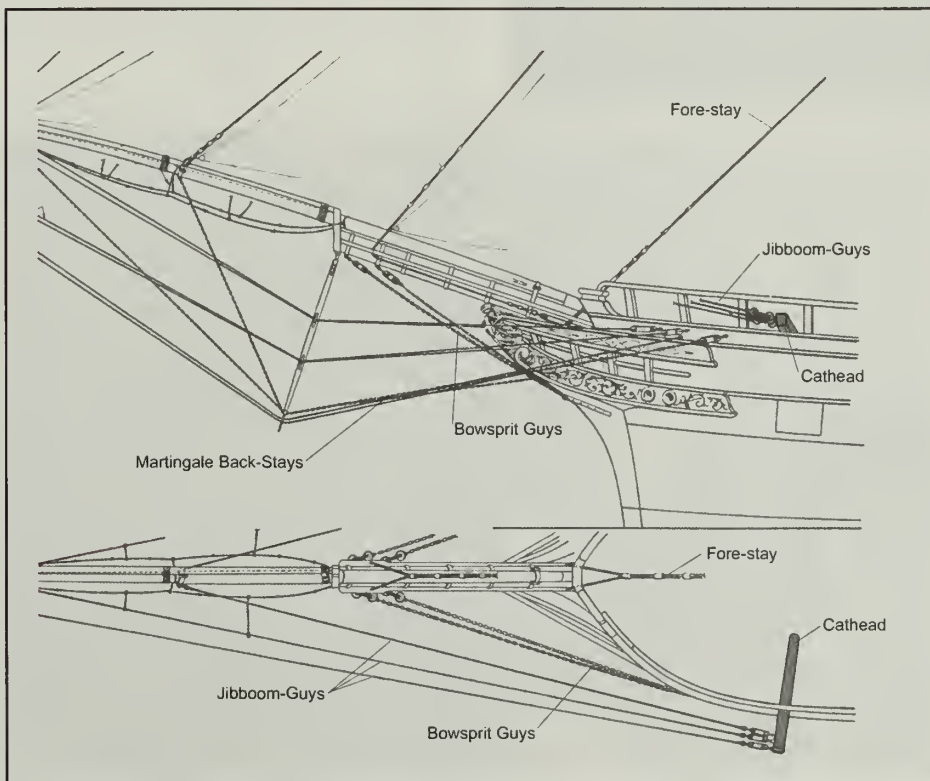
Another single bull's eye attached to a  $1\frac{1}{2}$ -in. diameter iron rod is bent over on top of the bowsprit (Figures 4.76 and 4.77). The bottom of the iron rod is buried in the sand below the bowsprit, so its attachment point could not be recorded. The bull's eye itself has the same dimensions as the bull's eyes described above.

This is most likely one of the attachment points for the fore-stay, which supported *Comet's* foremast. *C. A. Thayer* has identical bull's eyes supporting its foremast in the same location. Underhill (1958:64) also depicts a similar forestay configuration (Figure 4.89).

Located off *Comet's* port bow is an unattached iron rigging element (Figure 4.90 and 4.91; also Figure 4.75). It consists of a 4 ft. 3 in.-long iron rod with a 5 in. long x  $2\frac{1}{2}$  in. wide x  $\frac{1}{2}$  in. thick plate on one end, attached to an  $11\frac{1}{2}$ -in. long x  $\frac{3}{4}$  in. diameter iron fastener that is attached to a 1 ft.  $6\frac{1}{2}$ -in. long x 1-in. thick iron plate. The plate is pierced by two 1 ft. 3-in. long x 1-in. diameter eyebolts, each of which has an iron ring attached to an iron strop from a bull's eye or deadeye (the wooden block is no longer present), similar to those described above. In addition, the iron plate has two iron hooks cast as part of its upper surface. Although documentary research could not identify the element's proper name, its function was identified. This object was originally fastened to the foreside of the port cathead and provided



**Figure 4.88.** Bull's eye above and forward of the hawse pipe (at the top-center of photo) support the bowsprit guys on *C. A. Thayer* in San Francisco Maritime National Historical Park. NPS photo by Matt Russell.

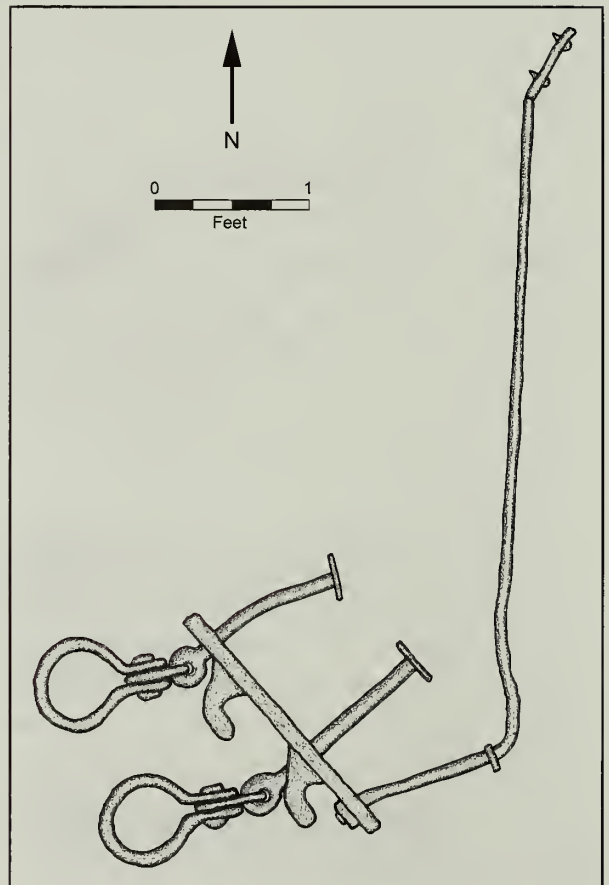


**Figure 4.89.** Bow rigging elements found on *Comet* site (after Underhill 1958:64).



**Figure 4.90.** Rigging element off *Comet's* port bow. NPS photo by Matt Russell.

**Figure 4.91.** Rigging element from port cathead that secured the jibboom guys. Drawing by Matt Russell and Don Morris.



the attachment point for the inner- and outer-jibboom guys, or shrouds (Figure 4.89) (Underhill 1958:64). Chapelle (1973:398) notes that “as long as the schooners carried jibbooms the jibboom shrouds were set up with hearts, or small deadeyes, and lanyards on the foresides of the catheads.” *C. A. Thayer* has similar, though not identical, rigging elements on the foresides of its catheads, which support the jibboom guys (Figure 4.92). In addition, historical photos of *Comet* wrecked in Simonton Cove give indirect evidence for this identification. Although the photos do not show the cathead or this particular element, they depict the jibboom guys coming to a point that can only be on the foresides of the catheads (see Figures 3.12 and 3.13). The iron hooks are called jib stay hooks (Greenhill and Manning 1995:103), and the iron rod was a brace between the cathead and the rail (Chapelle 1973:398). The rod’s angle identifies this object coming from the port, rather than the starboard, cathead.

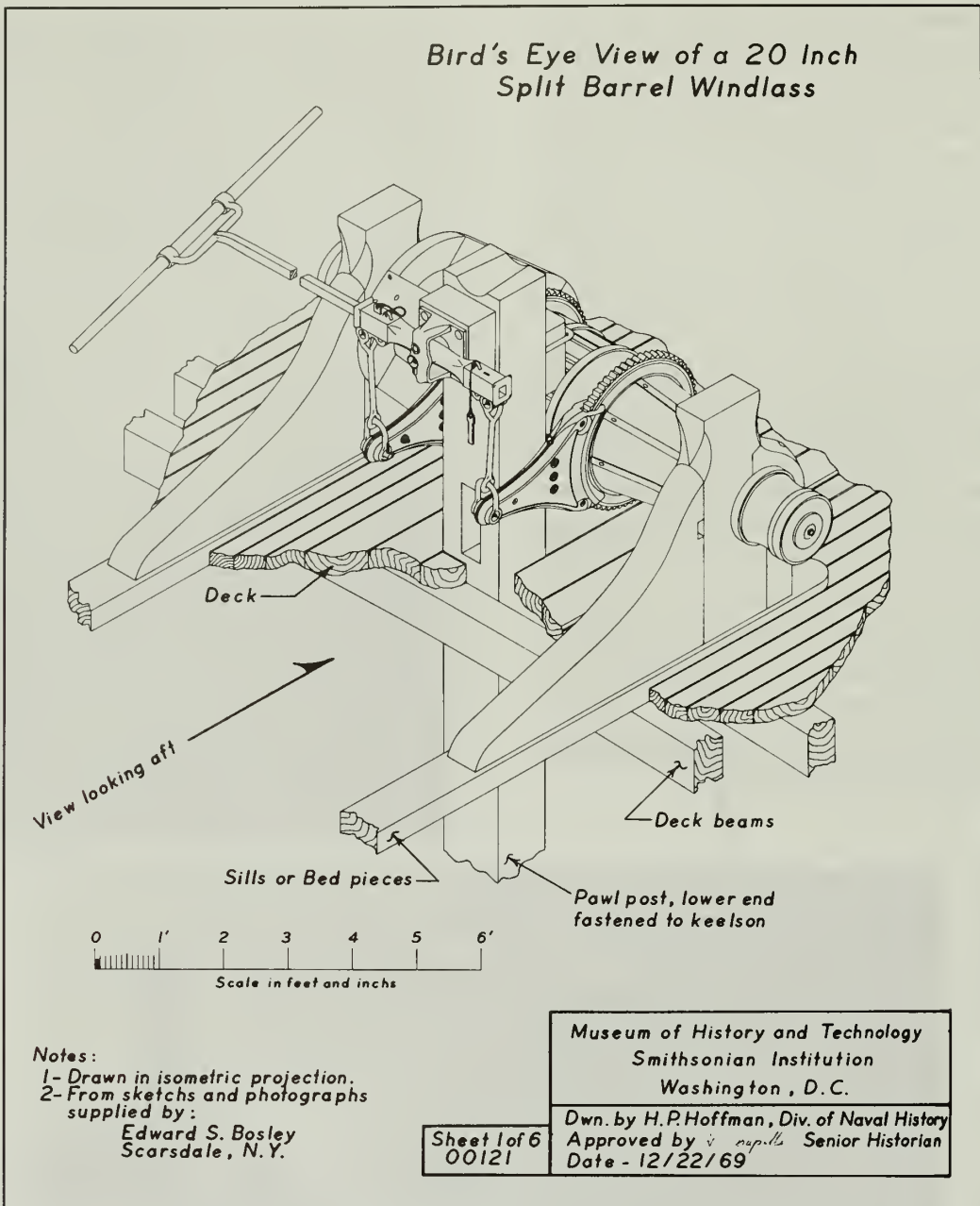
## GROUND TACKLE

Ground tackle is a collective term referring to gear associated with anchoring. In *Comet*’s case, this includes the windlass and disarticulated windlass parts, bow stopper, hawse pipe, starboard cathead and the anchor itself. Although not technically part of the ground tackle, the capstan is also discussed in this section. *Comet*’s contract only notes that the vessel was equipped with a “24” windlass purchase . . . [and] #3 capstan . . .” (JPSL 1886).

*Comet*’s windlass is a type generically known as an “Armstrong Patent”, or pump-brake, windlass, which was introduced during the 1840s, quickly replacing older models employing handspikes. Pump-brake windlasses, which used purchase levers and pump handles, remained in use into the twentieth century (MacGregor 1984:88). Chapelle (1973:677) refers to this type of windlass as a “wooden, or log, windlass, with pump-brake ironwork” (Figures 4.93).



**Figure 4.92.** Rigging element supporting jibboom guys on forward side of *C. A. Thayer*’s cathead. NPS photo by Matt Russell.



**Figure 4.93.** Pump-brake windlass. Drawing from the Smithsonian Institution.



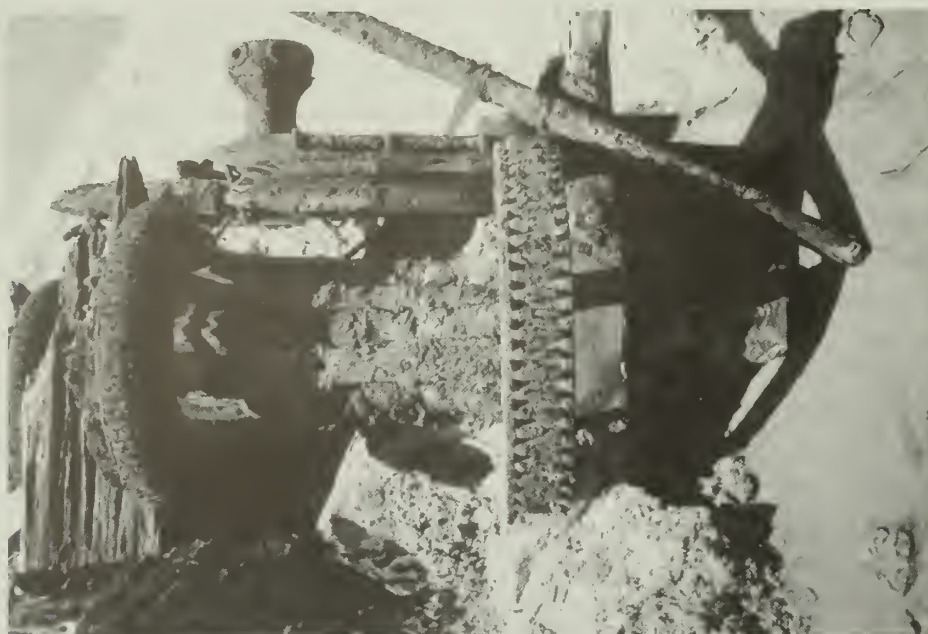
*Comet's* windlass is mounted on the schooner's main deck, just aft of the pawl post (Figure 4.94 and 4.95). The windlass has a wooden barrel with iron whelps supported by hardwood carrick bitts. It was worked with two iron purchase rims (with 1 ft. 11½ in., or 23½ in., inside diameter) and purchase arms connected by iron purchase rods to a pivoting rocker, or crosshead, mechanism that was originally mounted above the windlass on the forecastle deck (Figure 4.96)(Chapelle 1973:669–680; Paasch 1890:Plate 70). Just forward of the pawl post at forecastle-deck level are two fasteners and the remains of a block that supported the crosshead on the forecastle deck. On either side of the pawl post are openings in the forecastle deck where the purchase rods connected the windlass purchase arms to the rocker on the forecastle above (Figure 4.80).

On this windlass type, a pawl mounted on the aft face of the pawl post engaged either teeth cut into the center of the windlass barrel or an iron pawl rim mounted on the windlass barrel, which prevented the barrel from reversing direction (Figure 4.93) (Chapelle 1973:677; Paasch 1890:Plate 70). Neither the pawl nor a pawl rim is present on the *Comet* site, possibly indicating the pawl engaged teeth cut directly into the windlass barrel rather than a pawl rim. An auxiliary warping drum, or gypsy head, was present outside each carrick bitt (Figure 4.95). Only the starboard half of the windlass barrel remains intact, including the starboard purchase rim and arm, the starboard carrick bitt supporting the windlass, and the starboard warping drum outside it. Much of the windlass's port-side ironwork is present, however, laying loose on the main deck against the bowsprit's port side, including the port purchase rim (Figure 4.97), arm and rod; four iron whelps from the port-side windlass barrel; a single large iron fastener with a diamond-shaped rove that held

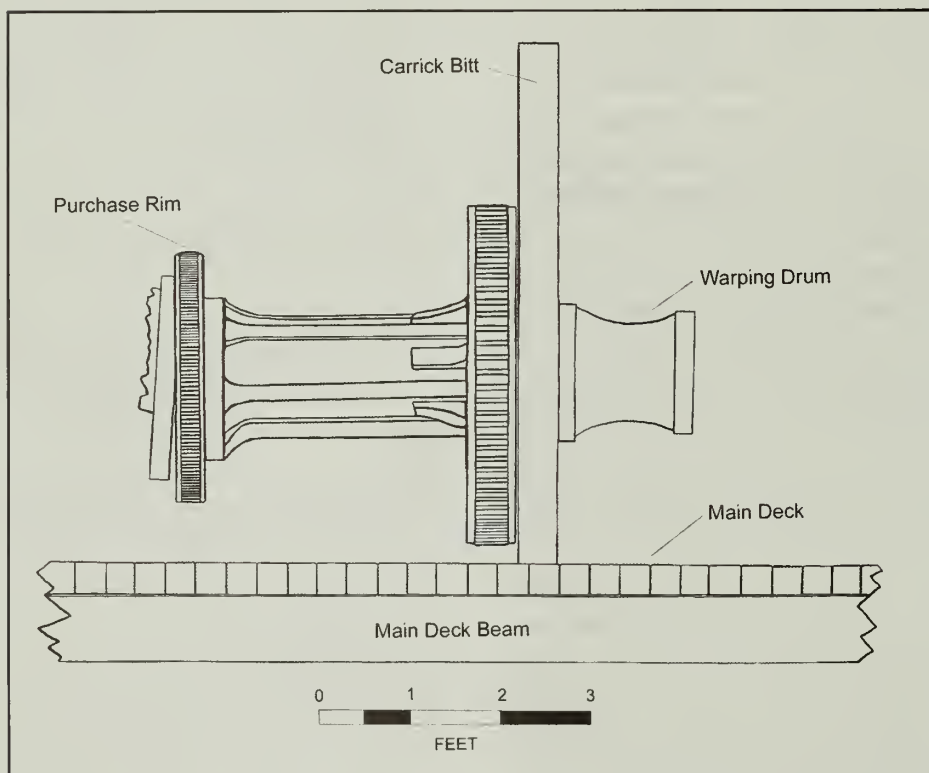
the port-side carrick bitt, cheek and knee together (an identical fastener is still in place on the starboard side); and the rocker base plate with two fasteners that held it to the forecastle deck (Figure 4.98).

On the windlass's starboard end, just inside the carrick bitt, is a 3 ft. 6½-in. diameter gear that is not integral to the primary workings of the windlass. In addition, an upright iron shaft with some heavily encrusted bands that may have been gearing is sticking out of the sand near the windlass's starboard end (Figure 4.99; see Figure 4.95). This is part of a messenger chain system for driving the windlass by an endless chain from a donkey engine. Figure 4.100 depicts a similar arrangement, with a geared shaft mounted above the windlass articulated to a large gear on the windlass's outside end. A similar system is depicted in drawings of *Bertha L. Downs*, another late-nineteenth century schooner (Figure 4.101) (Greenhill and Manning 1995:79–81, 90). Essentially, a messenger chain system was used to run several pieces of machinery off a single donkey engine. Using a system of shafts, gears and chains, a donkey engine could power the windlass, pumps, auxiliary warping heads and other hoisting equipment. As discussed in Chapter 3, *Comet* was probably not originally equipped with a donkey engine, but one was added in the 1890s.

Included in the iron material located on the main deck are an eyebolt fastened into the bowsprit's port face with another eyebolt attached to it, some small link chain with 2-in. long x ½-in. diameter links, 10 loose iron fasteners and an iron bar measuring 3½ to 4 in. square x 3 ft. 9½ in. long. The fasteners are probably from the windlass's port side, the link chain is possibly from the messenger chain or connected the purchase arm with the rocker (Figure 4.96) and the iron bar is possibly part of one of the pump-brake hand levers.



**Figure 4.94.** *Comet's* windlass mounted on the main deck. NPS photo by Matt Russell.



**Figure 4.95.** *Comet's* windlass, elevation view looking forward on main deck. Drawing by Jim Bradford and Matt Russell.



**Figure 4.96.** Pivoting rocker, or crosshead, mechanism connected to a windlass purchase arm with chain. *Comet* was equipped with a similar windlass type. NPS photo by Matt Russell.



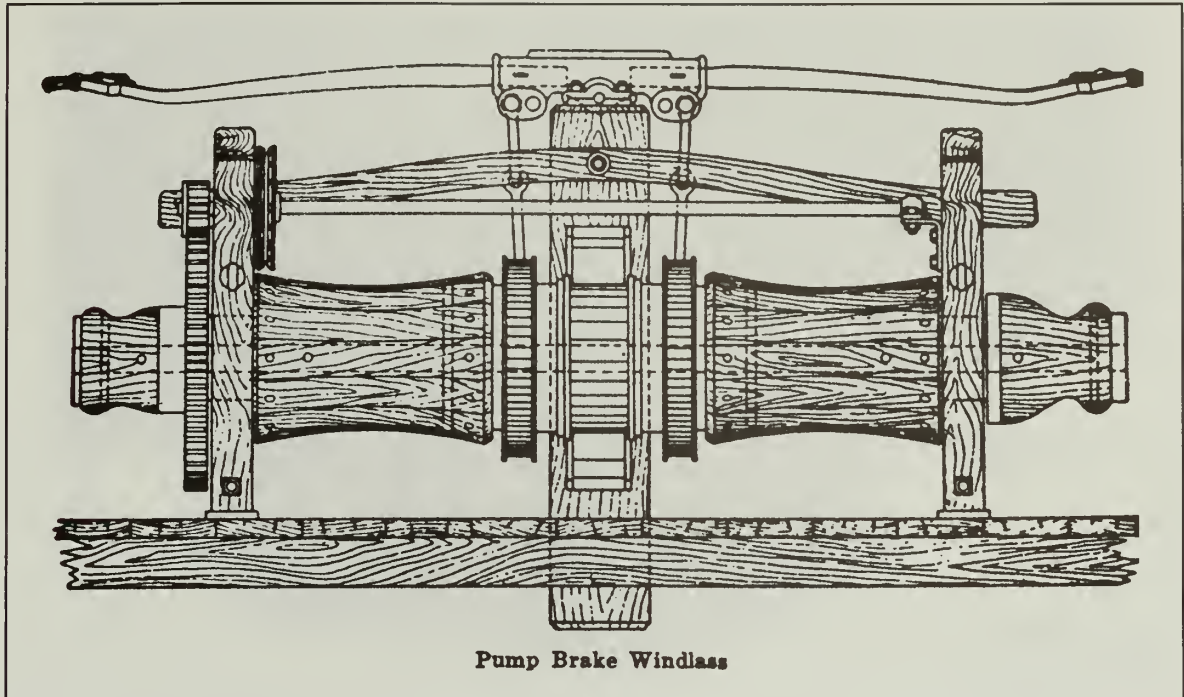
**Figure 4.97.** *Comet*'s port windlass purchase arm and windlass hardware on the main deck laying against the port side of the pawl post and bowsprit. NPS photo by Don Morris.



**Figure 4.98.** *Comet's* port windlass hardware laying on the main deck. NPS photo by Don Morris.



**Figure 4.99.** *Comet's* windlass and the iron shaft sticking out of the sand on the right side of the photograph. NPS photo by Matt Russell.

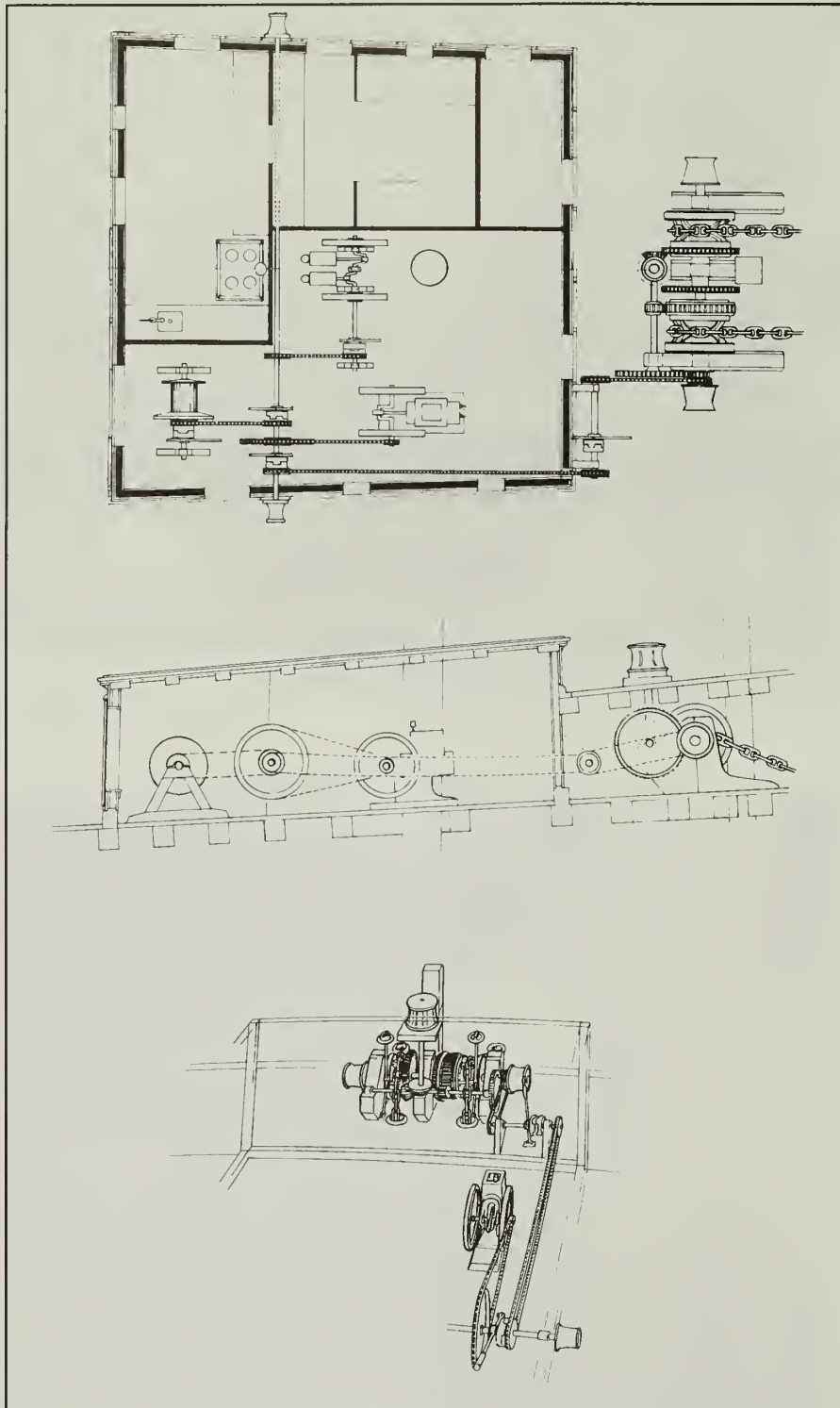


**Figure 4.100.** Windlass nearly identical to *Comet*'s windlass, including the gearing (in this case on the port side) for the messenger chain system.

Wood samples were taken from the windlass barrel and carrick bitt for wood species analysis. Both windlass and carrick bitt are hardwood, as specified in the contract (JPSL 1886). Field Sample #01 is from the carrick bitt and identified as prima vera wood (*Cybistax donnell-smithii*) (Puseman and Scott-Cummings 1999:1). Prima vera is a hardwood found only in Mexico, Guatemala, El Salvador and Honduras, and marketed as "white mahogany" (Puseman and Scott-Cummings 1999:1). This is unusual because no historical documentation for importation of Central American timber to the Pacific Northwest for use in ship construction could be located. Exporting Pacific Northwest timber to Mexico and Central and South America has been documented, so it is plausible that local species were carried north as a return cargo. On the other hand, use of this native Central American timber for the carrick bitts could represent a repair carried out while

delivering cargo to a Central American port. Field Sample #02 is from the windlass barrel and identified as California laurel (*Umbellularia californica*) (Puseman and Scott-Cummings 1999:1). California laurel is a hardwood native to California and Oregon and was used "under the keel in launching ships; appears to resist crushing better and have more 'slip' than any other local species" (Panshin and Zeeuw 1980:587 quoted in Puseman and Scott-Cummings 1999:2). These same qualities would be ideal for a windlass barrel hauling in an anchor with several wraps of chain around it.

The port hawse pipe is in place, piercing the port hull at main-deck level (Figure 4.102). The hawse pipe provided an opening for the anchor chain cable to pass through the bow to the windlass, and from the windlass into the chain locker. The hawse pipe is a flanged iron pipe with an outer face angled to fit the shape of the outer hull. The flanged opening is 1 ft. 5 in.



**Figure 4.101.** Messenger chain-driven windlass system (from Greenhill and Manning 1995:79 and 90).



**Figure 4.102.** *Comet's* port-side hawse pipe. NPS photo by Don Morris.

long x 1 ft. 6 in. wide, and the hawse pipe has an 11-in. interior diameter. Doing the same kind of analysis as above for the hawse pipes in Northwest Cove gives a different result. Using the same tables in Desmond (1919[1984]), a 400-ton vessel should carry a 1 1/8 in. diameter chain cable, which requires a 10<sup>3</sup>/<sub>4</sub> in. hawse pipe. This matches very well with *Comet's* 11-in. inside diameter hawse pipe. This complicates the identification of the shipwreck in Northwest Cove.

Mounted on the main deck just inside the port hawse pipe is a wood-and-iron hawse block, also called a bow stopper or riding chock (Figure 4.70)(Chapelle 1973:491). The hawse block routed the chain cable up and over the lower inboard rim of the hawse pipe (Chapelle 1973:491). Sometimes the hawse block was fitted with a chain stopper, which held the chain in addition to the windlass, but there is no evidence of a chain stopper on *Comet*. The

hawse block is 2 ft. 6 in. long x 10<sup>3</sup>/<sub>4</sub> in. wide x 8 in. high in the center. Its upper surface is rounded and has an iron pad in the center to resist chain abrasion.

The aft end of the starboard cathead was visible attached to the forecastle deck (Figures 4.80 and 4.81). A cathead is a wood beam that projects out over port and starboard bow to support the anchor before releasing or while retrieving or stowing (Figure 4.89) (de Kerchove 1961:132)—when the anchor ring has been hoisted up to the cathead, it has been “catted.” *Comet's* cathead is a solid timber, 11<sup>1</sup>/<sub>4</sub> in. wide x 5 in. thick with an exposed length of 2 ft. 7 in. A 3<sup>3</sup>/<sub>4</sub>-in.diameter, 1-in. thick iron ring is fastened to its upper surface at the lowest exposure, 2 ft. 7 in. from the aft end. No other details about the cathead were observed because most of its length was buried.

The most obvious ground tackle element remaining is the anchor. The iron, collapsible-

stock anchor is resting on the remains of the main deck's starboard side. It was uncovered and recorded in 1993, and a full analysis is found above. The anchor weighs approximately 616 lbs. and is most likely *Comet's* stream anchor.

A hand-powered capstan is mounted in the center of the forecastle deck (Figures 4.103 and 4.104). It is not linked to the windlass, so is not technically part of the ground tackle. It was used for warping only, including such tasks as handling lines and assisting with raising sail (Campbell 1974:135). The capstan is 2 ft. 10 in. tall, with a 2-ft. 8-in. diameter base and 1 ft. 8-in. diameter head. This is presumably the "#3 capstan" specified in *Comet's* contract.

### SITE FORMATION PROCESSES

An important aspect of this study was to determine the natural and cultural site formation processes that worked to create the

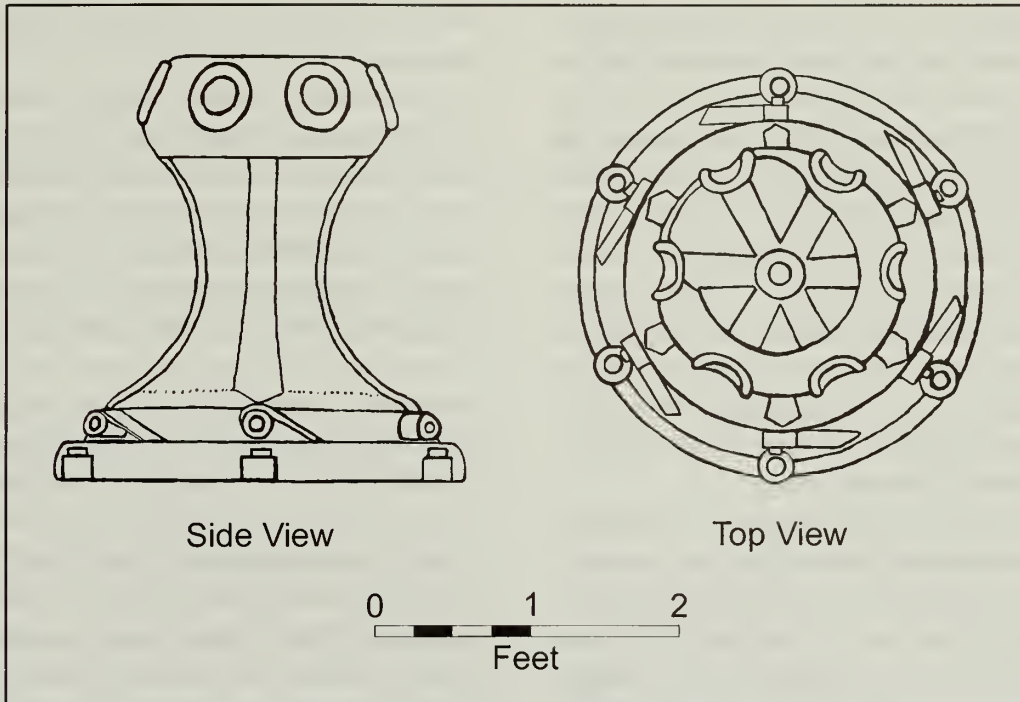
archeological record present today. Like any other archeological site, wreck scatters at Northwest Cove and Cluster Point, and the *Comet* site in Simonton Cove are subject to predictable natural and cultural transformations. An understanding of these mechanisms is important for site interpretation, a theoretical orientation advocated by Schiffer (1987).

If it is to be believed that shipwrecks occurred in Northwest Cove and Cluster Point, then the first step is to explain the paucity of hull material present at each of these sites. With only a few ground tackle and machinery pieces, and even fewer structural elements and fragments present at these sites, it is obvious that the vast majority of each vessel wrecked there is no longer part of the observable material record. As discussed in Chapter 3, the historical record strongly supports Northwest Cove and Cluster Point as the locations where *J. M. Colman* and *Dora Bluhm* wrecked. If we accept



**Figure 4.103.** *Comet's* capstan, mounted in the center of the forecastle deck. NPS photo by Don Morris.





**Figure 4.104.** *Comet's* capstan. Drawing by Jim Bradford.

that as a given, we can then examine the various forces that worked to reduce each vessel to such a small collection of material.

Muckelroy's (1978) extracting filters and scrambling processes are useful in describing the transformations at work on the Northwest Cove, Cluster Point, and *Comet* sites. Extracting filters described by Muckelroy include the wrecking process, salvage and the disintegration of perishables (Muckelroy 1978:166–167). With some modification, these processes can be applied to the present study.

The wrecking process is the break-up and loss of material that occurs during and immediately after the wreck event. This process probably had a minimal affect on *J. M. Colman* and *Comet*, but was the primary factor in the loss *Dora Bluhm's* physical integrity. While certainly some loss of material occurred when *J. M. Colman* and *Comet* went ashore on San Miguel Island, reports of contemporary salvage

confirm that the hulls stayed largely intact for months or years after the wreck event (see Chapter 3). The historical record gives a different story for *Dora Bluhm*. According to contemporary newspaper accounts, the vessel broke-up completely shortly after striking Santa Rosa Island. Captain Oscar Johnson reported, “she immediately broke in two, and in less than an hour she was a total wreck (*Los Angeles Daily Times*, May 28, 1910:10).” In addition, there were no reports of salvage attempts made in the days following the wreck. Apparently, if the historical record is accurate, there was little trace of *Dora Bluhm* remaining after the wreck event. This is not surprising given the probable location of the wreck. The seabed offshore of Cluster Point and the surrounding areas is comparatively steep, with no shallow intertidal zone. If the vessel did break in two, then it is possible the remains quickly slipped into deeper water off Cluster Point. A systematic

magnetometer survey of the waters surrounding Cluster Point has not been conducted, so this has not been verified. Whether the vessel broke-up quickly after grounding and was dispersed, or sank largely intact and slowly disintegrated and dispersed, ground tackle (anchors, chain cable, windlass, etc.) and other machinery should still be present in the area. Elements and fragments recorded as part of the Cluster Point site could be pieces of *Dora Bluhm* that washed ashore during its initial break-up, or could have come ashore later after being dislodged from an offshore wreck concentration.

Salvage, both contemporary and modern, have been important factors in the site formation processes of all three sites. Salvage activities, in addition to being one of Muckelroy's primary extracting filters, are included in what Schiffer refers to as c-transforms, or cultural (human) formation processes (Schiffer 1987:7). Contemporary salvage was heavy on both *J. M. Colman* and *Comet*. As noted in Chapter 3, salvage of *J. M. Colman*'s cargo continued more than a year after the vessel's loss. During that time, it is probable that anything of value left on board, including personal effects and shipboard items, that were easily removed were also taken. *Comet*'s salvage is also discussed in Chapter 3. Although no records of exactly how much material was salvaged from the vessel, contemporary newspaper accounts suggest that salvage was extensive. Most likely, salvage efforts reduced both vessels to stripped hulks, and have therefore considerably affected the nature of the archeological remains. As noted above, contemporary salvage did not take place on *Dora Bluhm*, but modern salvage, or looting, has certainly played a part in the site's formation. The mast band, discussed earlier in this chapter, is the only documented instance of material looted from the site, but additional material has likely been removed. At this point, it is not known how much affect modern looting has had

on *Comet* and *J. M. Colman*, but it appears to be minimal.

Muckelroy's third extracting filter is the disintegration of perishables. This process appears to have more relevance to submerged archeological sites, though it can also apply to beached shipwreck remains. A related notion that is perhaps more useful in this case is natural, long-term break-up. This refers to the slow destruction of a grounded vessel caused by the continuous pounding of the sea, and it is probably the greatest contributing factor to the formation of the Northwest Cove and *Comet* sites. This process explains why so little of *J. M. Colman* remains in Northwest Cove. As the vessel slowly broke apart, elements and fragments either floated away or were washed up on the beach. Later storms and tides probably carried away or buried many wooden components from the beach, eventually reducing the visible material to the present collection. Because *J. M. Colman* did not carry ballast, nothing was present to trap and preserve the hull bottom. That a vessel did indeed break-up in Northwest Cove is evidenced by the iron material recorded in the intertidal zone. As noted before, the material is from a single vessel, and it could only have been deposited in the present location by a vessel deteriorating here and dropping it in place. Subsequent movement probably took place until the objects became concreted to the rocky bottom.

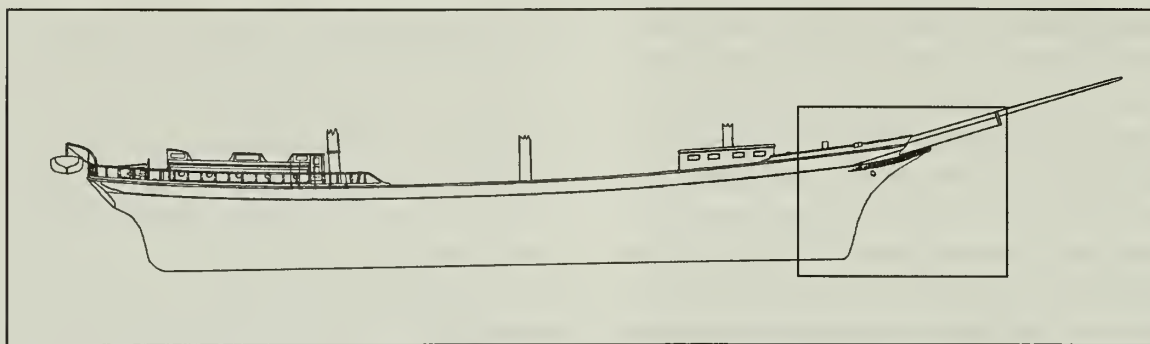
*Comet*, as it lay stranded on the beach, was subjected to this same process of natural break-up. Based on observation and analysis of historical photographs, particularly those made on the *Comet* site, a sequence of events can be developed to account for *Comet*'s present condition. No geomorphologic, sedimentologic or oceanographic studies were conducted to determine the exact natural forces that have acted on *Comet*'s remains over the past 88 years, so a complete examination of natural site

formation processes is not available at this time. Nor is a precise accounting of salvage activities on *Comet* available, although contemporary salvage is indicated. There are no obvious archeological indicators of salvage, so a discussion of cultural site formation processes is necessarily limited. What is offered is a brief description of contemporary salvage gleaned from the few available newspaper records, which can account for the absence of certain materials from the site and inform speculation of the hull break-up sequence and deterioration that led to the site's present condition.

Contemporary newspaper articles in the *Los Angeles Daily Times*, *Santa Barbara Morning Press* and *San Francisco Call* offer the only information on salvage activities after the wreck. The lumber cargo was the most valuable part of *Comet*'s wreck, and it is mentioned as being salvaged in several articles (*Santa Barbara Morning Press*, September 2, 1911:8; *Los Angeles Daily Times*, September 15, 1911:15; *Santa Barbara Morning Press*, September 22, 1911:8). The only two other objects mentioned specifically were rigging, some of which had already been salvaged at the time an article in the *Santa Barbara Morning Press* was published (*Santa Barbara Morning Press*, September 22, 1911:8), and the donkey engine (*San Francisco Call*, October 16, 1911:14). It is unknown if the donkey engine was ever salvaged, but it would have been one of the more valuable objects on board. Presumably the windlass, capstan, and anchor would also have been high-cost, reusable items, but they obviously were not salvaged. In general, limited newspaper discussions of salvage can explain the absence of some rigging, possibly the donkey engine and the lumber cargo from the site. Additional salvage almost certainly took place, but it is not documented historically. Opportunistic salvage probably also occurred as the schooner broke apart and pieces were scavenged for various

uses. Salvage alone cannot explain, however, why only the bow is present today. Observation of site layout suggests a series of events that led to the wreck's present condition. The last known historical photographs of *Comet* (see Figures 3.9–3.11) show the vessel laying broadside to the shoreline, somewhere between high and low tide. Subsequently, *Comet*'s bow broke away from the rest of the hull at a point just aft of the forecastle deck and forward of the forward deckhouse (Figure 4.105). It is possible the stempost/keel joint broke, but the pointers kept the bow structure to aft of the forecastle deck together. The pointers crossed and were fastened into multiple frame pairs, including all the cant frames, and would have provided reinforcement to help bind them together (Figures 4.85 and 4.86).

After it broke free from the rest of the hull, the bow rotated 90° to face seaward, and possibly shifted closer to the embankment behind the beach. The bow must have detached from the hull before it rotated because there would not have been enough room on the beach for the entire vessel to rotate. After it broke free and rotated, the bow section heeled over to starboard and filled with sand to the level reflected in preserved structure observed on site during this study. Much of the port bow was exposed to the elements, and was, in effect, "sheared off" by natural deterioration. Exposed wood portions of the wreck, such as the port sides of the outer hull, forecastle deck, main deck and windlass, deteriorated and were removed from the site, probably by natural processes. This natural "shearing" process must have taken place after the bow broke away, rotated and heeled to starboard because of the evident "line" of preservation and the position of the iron features within the wreck site. Major iron features, including the anchor, port windlass hardware, and port cathead-rigging element, appear to have essentially dropped to their



**Figure 4.105.** Area of *Comet's* preserved hull.

current locations as their wooden support structures deteriorated. For example, the cathead rigging element dropped outside the hull when the cathead deteriorated, and the windlass' port-side hardware fell to its current location on the main deck against the bowsprit when the port half of the wooden windlass barrel deteriorated. This same process accounts for material observed on *J. M. Colman*.

Based on its location in the wreck, one interpretation of the anchor's location is that the anchor was catted and fished (when the anchor crown has been hoisted to the gunwale) on *Comet's* port side when the vessel wrecked. As the bow section heeled to starboard and deteriorated, the anchor simply dropped to its current location. If this sequence of events is accurate, then the question is: why did *Comet* have its stream anchor catted and fished on its port side, and not one of its bower anchors? Another problem with this interpretation is the lack of chain cable on site. An anchor would never have been catted without chain cable attached, and it seems unusual to salvage the chain while leaving the anchor catted. It is possible the chain was disconnected from the anchor ring, threaded through the hawse pipe, and then either removed or dropped into the chain locker. But why would salvagers disconnect the chain unless they meant to salvage it, and if the chain was salvaged, why was the

anchor left behind? A simpler explanation is that the stream anchor was not catted, but was stowed, unrigged, on the forecastle deck or on the main deck under the forecastle deck and lashed in place. Given the hold was completely full of lumber and the huge deckloads these schooners carried, on or under the forecastle deck would be nearly the only place a spare anchor could be stowed and be easily accessible. As *Comet's* port side deteriorated, the anchor could still have dropped to its current location. This would explain why chain cable was not rigged to the anchor. Deeper excavation could determine whether chain remains in the chain locker, or even if the starboard anchor depicted in Figure 3.9 is present below the hull. With this information a more complete interpretation could be made of site formation processes and salvage activities.

The majority of *Comet's* hull cannot be accounted for in the archeological record. Only about 10% of the hull was observed during this project. Significant natural forces worked to break the hull and separate the bow, but the location of the remainder of the hull is unknown. It is possible it is still buried elsewhere on the beach in Simonton Cove or was transported offshore and settled into the sediment. Alternatively, it could have gradually broken up and the pieces floated off into the Santa Barbara Channel. Further research, especially terrestrial

and marine magnetometer surveys, could determine if significant hull remains are present elsewhere in Simonton Cove.

Although it is most likely that *Dora Bluhm* broke-up in a single event and was not affected by natural break-up, its remains on the beach were probably subjected to the same storm activity and tidal processes as *J. M. Colman*, which have carried away or buried many elements and fragments, leaving the present collection.

One question that remains, given that the same forces of natural break-up acted on both *J. M. Colman* and *Comet* is why was the lower hull of *Comet* preserved, and almost the entire hull of *J. M. Colman* broken-up and carried away? The answer must consider other variables that differed between the wreck sites. In this case, an important factor is the physical environment at the location of each wreck site. *J. M. Colman* grounded on a shallow, rocky intertidal zone. As the forces of natural break-up worked to dismantle and disperse the hull, there was nothing to protect the lower hull and preserve it. Therefore, it was broken up and carried away like the rest of the vessel. *Comet*, on the other hand, grounded on a sandy beach, which buried the lower hull and likely preserved it when the rest of the hull had been broken-up and lost. Physical environment of the wreck site, then, plays a key role in site preservation.

Another variable that must be considered is the weather conditions encountered by the vessel during the wreck event. Considering the similar physical environments between the wreck locations of *Comet* and *Dora Bluhm*, this is also an important factor. In this case, even though *Dora Bluhm* struck a sandy shore, similar to *Comet*, the storm completely destroyed the vessel before there was any chance of burial and preservation.

Several other factors have also contributed to the formation of these archeological sites.

Due to the complex interaction of ocean currents in and around the Santa Barbara Channel, miscellaneous flotsam from both northern and southern California are deposited on the beaches of the Channel Islands. This has introduced an incredible variety of intrusive materials to all three sites. Although this complicates the archeological picture, the intrusive material can be identified and rejected through rigorous field methodology and analysis, as demonstrated in this study.

Sediment movement is another important formation process. Constant sand movement caused by wind, tides and storm activity periodically bury and expose elements and fragments at all three sites, although to a lesser extent in Northwest Cove, where there is little loose sand. Site exposure at the time of recording considerably affects the overall archeological picture. After initial recording, periodic monitoring of the sites is necessary to record elements and fragments that may have been exposed subsequently. This is particularly true with the *Comet* site, which is periodically exposed after strong winter storms.

To an unknown degree, animals and plants also affect the observed archeological record. This is especially true in Northwest Cove. Point Bennett, which includes Northwest Cove, is home to one of the largest concentrations of pinnipeds (sea lions, seals and elephant seals) in the western hemisphere. The area is literally covered with thousands of these large mammals. On numerous occasions during recording of the Northwest Cove site, pinnipeds were observed crawling over and lying on top of wooden elements and fragments. When extended over the 90-year history of the site, these animals may have had a considerable affect on site features. Elements and fragments may have been broken and diagnostic features of the timbers have possibly been worn away. At this time, we have

no clear understanding of how the pinnipeds have affected site integrity.

Similar to the effect of sand movement, sea grass in Northwest Cove's intertidal zone covers most of the seabed, masking many site features. Undoubtedly, many small features in this area were missed because they were blanketed and hidden by sea grass. This has affected our overall picture of the material record in Northwest Cove.

Another important aspect of examining site formation processes is to explore alternative ways of explaining the observed material record. Prior to this research, we have assumed the wooden features recorded at the Northwest Cove and Cluster Point sites were deposited by shipwrecks. In each case, however, the possibility exists, given the variety of winds and currents active in the region that the collection of wooden elements and fragments studied floated there.

There is no doubt how the iron objects in Northwest Cove's intertidal zone were deposited there. These features are clearly shipboard objects associated with ground tackle and deck machinery, and it is physically impossible that they floated to this location unless attached to a whole bow structure and much of a vessel's length. The more reasonable conclusion is that the iron material was deposited directly from a wrecked or stranded vessel.

To test whether the wooden material at each site could have floated to its present location, the specific gravity of the keelson fragment (PB-001) at the Northwest Cove site plus its iron fasteners (which is the largest timber containing the most iron fasteners) was calculated. The specific gravity of water is 1, so any value less than 1 represents a buoyant object, and greater than 1 a nonbuoyant object. Specific gravity is a simple calculation of weight (grams) divided by volume (cubic centimeters). Using tables found in Desmond (1919[1984]:18, 213), the

Douglas fir timber of PB-001 weighs approximately 2,200 lbs., assuming a regular rectangular shape, while the iron fasteners altogether weigh about 170 lbs. The timber and fastener's rounded-off volume is approximately 55 square ft. The timber and fasteners specific gravity is approximately 0.69. This means the timber is positively buoyant, and would float if not waterlogged. Consequently, it is possible that any of the wooden elements and fragments recorded at the Northwest Cove and Cluster Point sites could have been deposited there from anywhere along the California coast by wind and current. For the identified structural elements and fragments recorded at these sites, this possibility is unlikely, given the historical associations, and the fact that the timbers and fasteners are consistent with the *Rules for the Construction of Wooden Vessels* for a vessel of *J. M. Colman's* tonnage and the contract specifications for *Dora Bluhm*. This just gives us another way to explain the presence, or absence, of wooden material found on the beach at these sites.

This study has shown that even widely scattered beached shipwreck sites can be systematically and productively interpreted. Although the Northwest Cove and Cluster Point sites contained small amounts of vessel-related material, it was possible to determine for each element and fragment whether it was a structural hull member or not, to tentatively identify it, and, after comparing to original construction contracts and the *Rules for the Construction of Wooden Vessels*, determine whether association with *J. M. Colman* and *Dora Bluhm* was likely. Examining site formation processes identified possible transformations to each site, resulting in the present observable material record. Although frequently discounted in the past, systematic investigation of isolated shipwreck elements and fragments using multiple data sets, historical references, insurance requirements and

formation processes can produce credible and useful archeological inferences. Monitoring the sites over time will increase our knowledge of beached shipwreck dynamics as features shift position and additional material is uncovered, and continue to augment what is known of these three vessels and the Hall Brothers Shipyard practices.

Overall, *Comet* is a remarkably well-preserved piece of Pacific Coast maritime history and a significant archeological site. The nearly intact bow section provides much information about Pacific Coast shipbuilding and site formation processes. In general, taking into account timber erosion, *Comet's* scantlings and fastenings met or exceeded those specified in its contract and published classification rules indicating the schooner was built as part of a mature and well-established Pacific Coast

shipbuilding industry. Several structural features, such as thickened ceiling planking and larger deck beams, are likely construction characteristics specific to Pacific Coast lumber schooners and reflect particular needs of these bulk lumber carriers and requirements of Pacific Coast environmental conditions. They may also represent practices of the Hall Brothers Shipyard. The site's integrity directly contradicts the often-repeated notion that shipwreck remains cannot be preserved in any significant way in high-energy environments. Like other West Coast examples, such as *King Phillip* on Ocean Beach in Golden Gate National Recreation Area (Delgado 1985), *Comet* demonstrates that under certain environmental conditions, wooden shipwreck remains can be quickly buried by beach sands and preserved.





## CHAPTER 5

### Conclusions

---

This investigation of *J. M. Colman*, *Dora Bluhm*, and *Comet*'s wreck sites in Channel Islands National Park demonstrates the feasibility and value of rigorous study of scattered, beached shipwreck sites. Beached shipwreck material offers valuable evidence concerning coastal geomorphology and site formation processes relevant to archeological investigations. Scattered remains can be used to analyze historical records by comparing scantling dimensions, wood type, and fastener types and patterns to published classification records and original vessel contracts. This information in turn clarifies the larger historical picture concerning nineteenth century maritime industry by documenting trade patterns, vessel use, technological change and construction techniques.

Study of the scant remains at the Northwest Cove and Cluster Point sites has demonstrated what can be learned from scattered, beached shipwreck remains. Although conclusions about feature associations with the Hall-built

schooners must ultimately remain inconclusive, the evidence collected has shown the likelihood that many of these features are from *J. M. Colman* and *Dora Bluhm*. This is especially true of the iron material in Northwest Cove's intertidal zone. The steam donkey-engine boiler, hawse pipes, pump-brake windlass crosshead mechanism, and other windlass and donkey engine parts, because they are unduplicated, associated, and are of comparable size, are most likely from a single wrecked vessel. This collection is consistent with elements of ground tackle and machinery expected aboard a late-nineteenth century Pacific Coast lumber schooner. *J. M. Colman* is historically documented to have wrecked in this location, which makes the circumstantial evidence for this artifact collection's association with that vessel very strong.

Although the same degree of certainty cannot be assigned to the remaining features of the Northwest Cove and Cluster Point sites, this project has shown that rigorous, systematic

testing and examination of even widely scattered, disarticulated elements and fragments can produce viable interpretations that contribute directly to our knowledge. By using the methodology developed: comparing element and fragment shape and characteristics; scantling size; fastener type, size and number; and wood species to original construction contracts and published classification rules, it is possible to distinguish between structural and nonstructural members, and offer element and fragment identification. In this way, it has been demonstrated that several features from Northwest Cove and Cluster Point are most likely structural members from wooden, ocean-going vessels with construction consistent with late-nineteenth century practices. This makes association with *J. M. Colman* and *Dora Bluhm* a high probability. Once association is established, the disarticulated elements and fragments can be examined for undocumented construction details, such as variation from standard practice or repairs, as demonstrated by the unusual use of wooden plugs in feature PB-002.

Even though only about 10% of *Comet's* hull was observed in the course of this study, the schooner's bow section is one of the most well preserved historical shipwreck sites in Channel Islands National Park, as well as one of the best-preserved wooden shipwrecks recorded on the West Coast. It represents a regionally important vessel type linked to the economic development of major metropolitan areas on the Pacific Coast, and it offers insight into West Coast shipbuilding practices, especially those particular to lumber schooners.

One of the important outcomes of this project is that the information gathered can be applied to the study of site formation processes and the dynamics of scattered, beached shipwreck remains. Probably the most compelling observation of these sites is that the majority of the vessels wrecked at Northwest

Cove and Cluster Point are gone, yet *Comet* has been well preserved for nearly a century. The obvious question is, what became of the first two, and why was *Comet* preserved? The answer to this question is valuable to the study of how wooden shipwrecks break up and are distributed, and when and under what circumstances they are preserved. Unfortunately, these questions are not easily answered because there are many variables, and few controls or comparisons at this early stage of beached shipwreck research. An examination of the many transformation processes, both natural and cultural, that affected the formation of the observed archeological record, however, offers a more complete understanding of each site. Even if no further remains of these vessels are located, the features recorded can tell us about the dynamics of isolated remains and scattered, beached shipwreck elements. Periodic monitoring of the recorded material can demonstrate how natural forces affect these sites and may produce additional information as other elements and fragments are uncovered.

Documentation of *Comet* and the possible *J. M. Colman* and *Dora Bluhm* sites has been an important step in expanding our body of knowledge of a significant part of Pacific Coast maritime history. The archeological record of Hall-built schooners is extremely sparse. As briefly noted in Chapter 1, there are only two other known wreck sites of Hall Brothers' vessels. The first, the schooner *Reporter*, is located within the boundaries of Golden Gate National Recreation Area, buried under the sands of Ocean Beach, San Francisco. This three-masted schooner was constructed by the Hall Brothers in 1876 and wrecked on Ocean Beach in 1902. A few scattered rigging elements were examined adjacent to the medium-clipper *King Philip*, which was exposed on Ocean Beach during the mid-1980s (Delgado 1985). In addition, a terrestrial magnetometer

conducted on the beach in 1987 revealed a large anomaly in the area where *Reporter* remains are believed to lie (Gearhart 1988). With the possible exception of *Comet*, the *Reporter* site represents the most extensive remains of a Hall-built schooner yet located.

The other possible Hall Brothers' vessel remains were recorded by the North Carolina Underwater Archaeology Unit, just north of Cape Hatteras National Seashore on the beach at Nag's Head, North Carolina. A section of hull side constructed of Douglas fir and exhibiting construction consistent with late-nineteenth century practice was documented in 1979. Historical research revealed that, because of the Pacific Coast building material, the remains were most likely those of the four-masted, Hall-built schooner *Bainbridge*, constructed in 1900 and lost in 1929 (Richard Lawrence, personal communication 1993). Unfortunately, this section of the wreck was removed from the beach and destroyed by the property owner shortly after it was recorded. No further remnants of *Bainbridge* have been observed.

The paucity of vessels constructed by the Hall Brothers in the archeological record makes the documentation of the three sites in Channel Islands National Park particularly important. Of equal importance, however, is the use of this project as a methodological case study for interpreting isolated features and scattered shipwreck structure. The process of systematically studying and analyzing each element and fragment to determine its possible association and identification is the key to understanding scattered, beached shipwreck sites.

This study should be seen as a model for archeologists and resource managers of how this specific type of site, beached shipwreck scatters,

should be approached to maximize research potential. The value of beached shipwreck scatters as cultural resources demanding equal consideration has been demonstrated. Up until now, few have acknowledged their importance, and they are often thought of as unimportant, even ephemeral because of the transitory nature of the resources. This study should help change the common perception of beached shipwreck scatters, and resource managers are encouraged to develop documentation programs for scattered beached remains and environmentally exposed shipwrecks. Such a program was recently implemented at Gateway National Recreation Area and Fire Island National Seashore in New York (Agranat 1994), and has long been standard practice at Channel Islands National Park, Golden Gate National Recreation Area and Point Reyes National Seashore in California. In addition, the State of North Carolina Underwater Archeology Unit regularly records and monitors shipwreck elements, fragments and hulls exposed on the beaches of North Carolina, including Cape Hatteras National Seashore (Bright 1993).

The importance of the Pacific Coast lumber trade and the principal vessel involved in that trade, the Pacific Coast lumber schooner, has been clearly demonstrated. The lumber trade's role in the economic development of California and other regions offers ample testimony to its significance. The importance of the Northwest Cove, Cluster Point and *Comet* sites goes beyond their association with that trade however. These sites represent nonrenewable archeological resources that offer insights into natural site formation processes, isolated element dynamics, and details of late-nineteenth century construction practices available nowhere else. It is clear that these sites deserve our attention, both to study and to preserve them.



## REFERENCES

- Agranat, B. J.**  
 1994 Final Proposal: Beach Shipwreck Tracking and Recording, Fire Island National Seashore and Gateway National Recreation Area—Breezy Point and Sandy Hook Units: Pilot Project. Ms. on file, Fire Island National Seashore.
- American Shipmasters' Association**  
 1879 Record of American and Foreign Shipping. New York.  
 1907 Record of American and Foreign Shipping. New York.
- Anonymous**  
 1872 *Business Directory and Guide to Washington Territory*. Murphy & Harned, Olympia, Washington.
- Barkhausen, H. N.**  
 1990 *Focusing on the Centerboard*. Manitowoc Maritime Museum, Manitowoc, Minnesota.
- Barsness, R. W.**  
 1965 Iron Horses and an Inner Harbor at San Pedro Bay, 1867–1890. *Pacific Historical Review* XXXIV August:289–303.
- Bauer, K. J.**  
 1981 Pacific Coastal Commerce in the American Period. *Journal of the West* XX July:11–18.  
 1988 *A Maritime History of the United States*. University of South Carolina Press, Columbia.
- Bright, L. S.**  
 1993 Beached Shipwreck Dynamics. Paper read at Society for Historical Archaeology Conference, Kansas City.
- Browne, D. R.**  
 1994 Understanding the Oceanic Circulation in and Around the Santa Barbara Channel, *The Fourth California Islands Symposium: Update on the Status of Resources*. Edited by W. L. Halvorson and G. J. Maender, pp. 27–34. Santa Barbara Museum of Natural History, Santa Barbara.
- Campbell, G. F.**  
 1974 *China Tea Clippers*. David McKay, New York.
- Chapelle, H. I.**  
 1935 *The History of American Sailing Ships*. Bonanza Books, New York.  
 1973 *The American Fishing Schooners: 1825-1935*. W. W. Norton, New York.
- Chasan, D. J.**  
 1981 *The Water Link: A History of Puget Sound as a Resource*. Puget Sound Books, Seattle.
- Cox, T. R.**  
 1974 *Mills and Markets: A History of the Pacific Coast Lumber Industry to 1900*. University of Washington Press, Seattle.

- 1981 Single Decks and Flat Bottoms: Building the West Coast's Lumber Fleet, 1850–1929. *Journal of the West XX*, July:65–74.
- Curtis, W. H.**  
1919 *The Elements of Wood Ship Construction*. Hill Publishing, London.
- de Kerchove, R.**  
1961 *International Maritime Dictionary*. Van Nostrand Reinhold, New York.
- Delgado, J. P.**  
1985 Skeleton in the Sand: Documentation of the Environmentally Exposed 1856 Ship *King Phillip*, San Francisco. In *Proceedings of the Sixteenth Conference on Underwater Archaeology*, edited by Paul Forsythe Johnston, pp. 30–36. Society for Historical Archaeology, Tucson.
- 1986 Documentation and Identification of the Two-Masted Schooner *Neptune*. *Historical Archaeology* 20(1):95–108.
- Delgado, J. P. and S. A. Haller**  
1989 *Submerged Cultural Resources Assessment: Golden Gate National Recreation Area, Gulf of the Farallones National Marine Sanctuary, and Point Reyes National Seashore*. Submerged Resources Center Professional Report, No. 7 (originally published as Southwest Cultural Resources Center Professional Papers, No. 18). National Park Service, Santa Fe.
- Delgado, J. P. and L. E. Murphy**  
1984 Environmentally Exposed Shipwreck Remains: Implications for a Natural Site Formation Process. Paper read at the *Fifteenth Annual Conference on Underwater Archeology*, Williamsburg.
- DeLong, H. T.**  
1985 *Pacific Schooner Wawona*. Documentary Book, Bellevue, Washington.
- Desmond, C.**  
1984 *Wooden Shipbuilding*. Reprinted. Vestal Press, New York. Originally published 1919, Rudder Publishing, New York.
- Drury, A.**  
1952 *John A. Hooper and California's Robust Youth*. Lawton Kennedy, San Francisco.
- Eaton, M. H.**  
1980 *Diary of a Sea Captain's Wife: Tales of Santa Cruz Island*. Edited by Janice Timbrook. McNally & Loftin, Santa Barbara.
- Edson, M. A., Jr.**  
1989 The Schooner Rig, Its First Appearance and Development. *The American Neptune* XLIX, Summer:198–207.
- Gearhart, R. L., II**  
1988 *Cultural Resources Magnetometer Survey and Testing Great Highway/Ocean Beach Seawall Project, San Francisco, California*. Espey, Huston & Associates, Austin.
- Gould, R. A. (editor)**  
1983 *Shipwreck Anthropology*. University of New Mexico Press, Albuquerque.
- Greenhill, B.**  
1980 *Schooners*. Naval Institute Press, Annapolis.

- Greenhill, B. and S. Manning**  
1995 *The Schooner Bertha L. Downs*. Naval Institute Press, Annapolis.
- Hall, H.**  
1884 *Report on the Shipbuilding Industry of the United States*. US Government Printing Office, Washington D.C.
- Haller, S. A. and R. Kelly**  
1990 *Schooners, Sealers, and Steamers: Shipwrecks of San Miguel and Santa Rosa Islands, Channel Islands National Park, California*. Ms. on file, San Francisco Maritime National Historic Park, San Francisco.
- Hittel, J. S.**  
1882 *The Commerce and Industries of the Pacific Coast of North America*. A. L. Bancroft, San Francisco.
- Hopkins, C. T.**  
1874 *Shipbuilding on the Pacific Coast (No. 2)*. San Francisco Board of Marine Underwriters, Alta California Printing House, San Francisco.
- Johansen, D. O. and C. M. Gates**  
1957 *Empire of the Columbia: A History of the Pacific Northwest*. Harper & Brothers, New York.
- Lenihan, D. J.**  
1983 *Rethinking Shipwreck Archaeology: A History of Ideas and Considerations for New Directions*. In *Shipwreck Anthropology*, edited by R. A. Gould, pp-37-64. University of New Mexico Press, Albuquerque.
- Los Angeles Daily Times*  
1883 The Lumber Trade. 10 June:4.  
1905 7 September.  
1905 9 September.  
1905 21 September.  
1905 18 October.  
1910 28 May.  
1911 New Theory about "Comet." 15 September:15.
- Luckenbach, J. J.**  
1943 American Bureau of Shipping, 1862-1943. Paper read at The Society of Naval Architects and Marine Engineers, New York.
- Lyman, J.**  
1945 Notes from the Henry Hall notebook in Penobscot Marine Museum, Searsport, Maine. *The American Neptune* Vol. V, April:85-87.
- 1951 Hall Brothers of Port Blakely. *Log Chips of Recent Maritime History* 2:109-110.
- MacGregor, D. R.**  
1982 *Schooners in Four Centuries*. Naval Institute Press, Annapolis.  
1984 *Merchant Sailing Ships: 1815-1850*. Conway Maritime Press, London.

- Marquez, E.**  
1975 *Port Los Angeles - A Phenomenon of the Railroad Era.* Golden West Books, San Marino.
- Martin, W. E. (editor)**  
1983 *Sail & Steam on the Northern California Coast, 1850-1900.* National Maritime Museum Association, San Francisco.
- McDonald, L.**  
1978 Hall Brothers Shipbuilding: Port Ludlow-Port Blakely. *The Sea Chest* Vol. II, March:99-108.
- McNairn, J. and J. MacMullen**  
1945 *Ships of the Redwood Coast.* Stanford University Press, Stanford.
- Mears, E. G.**  
1935 *Maritime Trade of the Western United States.* Stanford University Press, Stanford.
- Morris, D. P. and J. Lima**  
1996 *Channel Islands National Park and Channel Islands National Marine Sanctuary Submerged Cultural Resources Assessment.* Submerged Resources Center Professional Report No. 14 (originally published as Intermountain Cultural Resource Center Professional Papers No. 56). National Park Service, Santa Fe.
- Muckelroy, K.**  
1978 *Maritime Archaeology.* Cambridge University Press, Cambridge.
- Murphy, L. E. (editor)**  
1993 *Dry Tortugas National Park Submerged Cultural Resources Assessment.* Submerged Resources Center Professional Report No. 13 (originally published as Southwest Cultural Resources Center Professional Papers No. 45). National Park Service, Santa Fe.
- Murphy, L. E.**  
1983 Shipwrecks as Data Base for Human Behavioral Studies. In *Shipwreck Anthropology*, edited by R. A. Gould, pp. 65-89. University of New Mexico Press, Albuquerque.
- Murphy, L. E. and M. A. Russell**  
1997 Minimum Impact Archaeology. In *Encyclopaedia of Underwater and Maritime Archaeology*, edited by J. P. Delgado, 278-279. British Museum Press, London.
- Newell, G. (editor)**  
1966 *The H. W. McCurdy Marine History of the Pacific Northwest.* Superior Publishing, Seattle.
- Newell, G. and J. Williamson**  
1960 *Pacific Lumber Ships.* Bonanza Books, New York.
- Olmsted, R.**  
1972 *C. A. Thayer & the Pacific Lumber Schooners.* Ward Ritchie Press, San Francisco.
- Paasch, H.**  
1977 *Illustrated Marine Encyclopedia.* Reprinted. Argus Books, Watford, England. Originally published 1890, Model and Allied Publications, London.
- Puseman, K.**  
1994 *Identification of Wood Samples from Channel Islands National Park,*



- California, and from Dry Tortugas National Park and Biscayne National Park, Florida.* Ms. on file, Submerged Resources Center, Santa Fe.
- Puseman, K. and L. S. Cummings**  
 1999 *Identification of Wood and Fiber from the Comet, a Late-Nineteenth Century Lumber Schooner Wrecked on San Miguel, Channel Islands National Park, California.* Paleo Research Labs Technical Report 99-24. Ms. on file, Submerged Resources Center, Santa Fe.
- Roberts, L. J.**  
 1978 *Historic Resources Study: Channel Islands National Monument and San Miguel Island.* Chambers Consultants and Planners, Stanton, California.
- Russell, M. A.**  
 1996 *An Historical and Archaeological Investigation of Three Beached Shipwreck Scatters at Channel Islands National Park.* Unpublished Master's thesis, Department of History, East Carolina University, Greenville.
- Ryder, D. W.**  
 1948 *Memories of the Mendocino Coast.* Privately Printed, San Francisco.
- San Francisco Call**  
 1905 16 November.
- 1911 Launch Hit Schooner, Says Comet's Captain. 28 February:30.
- 1911 Captain of Comet Erratic in Orbit. 2 March:12.
- 1911 Salvage of Wrecked Boat Nets Purchasers Tidy Sum. 16 October:1.
- San Francisco Chronicle**  
 1892 16 November.
- 1892 23 November.
- 1892 26 November.
- 1892 9 December.
- 1892 17 December.
- 1892 30 December.
- 1893 6 January.
- 1893 12 January.
- 1893 25 January.
- 1893 8 February.
- 1893 14 February.
- 1905 7 September.
- 1905 10 September.
- 1910 28 May.
- San Pedro Daily News**  
 1910 27 May.
- Santa Barbara Independent**  
 1911 Lumber Steamer Comet is Wrecked Near San Miguel. 1 September.
- 1911 Breakers Pounding Wreck into Kindling. 14 September.

- 1911 Wreck of Comet May Bring Lighthouse. 16 September.
- Santa Barbara Morning Press**  
1906 3 November.
- 1911 Congress Fails to Act; Another Wreck on Miguel. 2 September.
- 1911 Comet's Mate Drowned Trying to Board Wreck. 3 September:1.
- 1911 Comet Wreck Sold to Owners of Santa Rosa. 22 September:8.
- Santa Barbara News Press**  
1906 3 November.
- Schiffer, M. B.**  
1987 *Formation Processes of the Archaeological Record*. University of New Mexico Press, Albuquerque.
- Underhill, H. A.**  
1958 *Masting and Rigging the Clipper Ship & Ocean Carrier*. Brown, Son and Ferguson, Glasgow.
- 1978 *Sailing Ships Rigs and Rigging*. Brown, Son and Ferguson, Glasgow.
- US Department of Commerce and Labor**  
1903 United States Coast Pilot: Pacific Coast. US Government Printing Office, Washington D.C.
- Vinnedge, R. W.**  
1923 *The Pacific Northwest Lumber Industry and Its Development*. Yale University, New Haven, Connecticut.
- Watson, P. J., S. A. LeBlanc and C. L. Redman**  
1984 *Archaeological Explanation: The Scientific Method in Archaeology*. Columbia University Press, New York.
- Weinstein, R. A.**  
1978 *Tall Ships on Puget Sound: The Marine Photographs of Wilhelm Hester*. University of Washington Press, Seattle.
- Williamson, J. and J. Gibbs**  
1976 *Maritime Memories of Puget Sound*. Superior Publishing, Seattle.

**APPENDIX A**  
**ENROLLMENT AND REGISTRATION DATA:**  
**SCHOONER *DORA BLUHM***

Registry: 157091

Built: Port Blakely, Washington, 1883

Shipbuilder: Hall Brothers Shipyard

Ownership:

- 1) Certificate of Registry (no. 33)  
 William G. Bluhm (1/4), William H. Smith (1/8), Albert Rowe (1/8), Thomas Wallace (1/16), M.M. Buckmann (1/16), Mary A. Redfield (1/16), William I McAllep (1/16), Winslow G. Hall (1/16) of San Francisco; Mary Bagley (1/16) of Vallejo; and W.M. Huntoon(?) (1/8) of Eureka.  
 30 April 1883 - 29 May 1883  
 William G. Bluhm, Master  
 First Registration  
 Port Townsend, Washington
- 2) Certificate of Enrollment (no. 333)  
 William G. Bluhm (3/16), Alexander Nicholson (1/16), others same.  
 29 May 1883 - 15 Sept 1883  
 William G. Bluhm, Master  
 Change of owners in part and change of home port  
 Port of San Francisco
- 3) Certificate of Registry (no. 15)  
 Owners same  
 15 Sept 1883 - 12 June 1884  
 William G. Bluhm, Master  
 Change of trade  
 Port Townsend
- 4) Certificate of Enrollment (no. 358)  
 Owners same  
 12 June 1883 - 11 June 1886  
 William G. Bluhm, Master  
 Change of home port and change of papers  
 Port of San Francisco
- 5) Certificate of Registry (no. 48)  
 Owners same  
 11 June 1886 - 26 August 1886  
 William G. Bluhm, Master  
 Change of trade  
 Port Townsend

- 6) Certificate of Enrollment (no. 28)  
Owners same  
26 August 1886 - 14 Jan 1887  
William G. Bluhm, Master  
Change of home port  
Port of San Francisco
- 7) Certificate of Registry (no. 52)  
Owners same  
14 Jan 1887 - 23 March 1887  
William G. Bluhm, Master  
Change of papers  
Port of San Francisco
- 8) Certificate of Enrollment (no. 154)  
William G. Bluhm (1/16), Henry Moore (1/8), others same.  
23 March 1887 - 5 Jan 1888  
Henry Moore, Master  
Change of owners in part and change of papers  
Port of San Francisco
- 9) Certificate of Registry (no. 42)  
Owners same  
5 Jan 1888 - 12 March 1888  
Henry Moore, Master  
Change of papers  
Port of San Francisco
- 10) Certificate of Enrollment (no. 204)  
Owners same  
12 March 1888 - 5 Jan 1889  
Henry Moore, Master  
Change of papers  
Port of San Francisco
- 11) Certificate of Registry (no. 78)  
Owners same  
5 Jan 1889 - 10 Aug 1889  
Henry Moore, Master  
Change of papers  
Port of San Francisco

- 12) Certificate of Enrollment (no. 19)  
Owners same  
10 Aug 1889 - 7 Nov 1889  
Henry Moore, Master  
Change of papers  
Port of San Francisco
- 13) Certificate of Registry (no. 49)  
Owners same  
7 Nov 1889 - 28 July 1890  
Henry Moore, Master  
Change of trade  
Port Townsend
- 14) Certificate of Enrollment (no. 16)  
Thomas Wallace (1/8), Buckmann dropped, others same.  
28 July 1890 - 6 Oct 1890  
Henry Moore, Master  
Change of owners in part  
Port of San Francisco
- 15) Certificate of Enrollment (no. 62)  
Frank E. Rensch (1/8), Moore dropped, others same.  
6 Oct 1890 - 23 Dec 1890  
Frank E. Rensch, Master  
Change of owners in part  
Port of San Francisco
- 16) Certificate of Registry (no. 41)  
Owners same  
23 Dec 1890 - 13 Mar 1891  
Frank E. Rensch, Master  
Change of papers  
Port of San Francisco
- 17) Certificate of Enrollment (no. 145)  
Roger Walton (1/8), Rensch dropped, others same.  
13 Mar 1891 - 25 Jan 1892  
Roger Walton, Master  
Change of owners in part and change of papers  
Port of San Francisco

- 18) Certificate of Registry (no. 60)  
 Thomas Wallace (1/16), Lewis P. Hearvey (1/16), Winslow Hall  
 (1/32), Henry Hall (1/32), others same.  
 25 Jan 1892 - 22 Aug 1892  
 Roger Walton, Master  
 Change of owners in part and change of papers  
 Port of San Francisco
- 19) Certificate of Enrollment (no. 35)  
 Owners same  
 22 Aug 1892 - 9 Sept 1892  
 Roger Walton, Master  
 Change of papers  
 Port of San Francisco
- 20) Certificate of Registry (no. 15)  
 Owners same  
 9 Sept 1892 - 2 Aug 1894  
 Roger Walton, Master  
 Change of trade  
 Port Townsend
- 21) Certificate of Enrollment (no. 22)  
 Jacob B. Levinson (5/8) and Sun Insurance Co. (1/8) of San  
 Francisco; Edward Lycan (1/8) of Vineland; William  
 Huntoon(?) (1/8) of Eureka  
 2 Aug 1894 - 5 Feb 1895  
 Jacob B. Levinson, Master (at time of enrollment)  
 Peter Rice, Master, 18 Oct 1894 (at Eur)  
 Change of owners and change of home port  
 Port of San Francisco
- 22) Certificate of Registry (no. 65)  
 J.H. Bruce (1/16) of San Francisco; A.A. Smith (1/16);  
 C.L. Clough (1/32); A. Dodd (1/8); J.K.C. Hobbs(?) (1/32);  
 F.W.G. Moebus (1/16) of Alameda; Joseph Knowland (1/8) of  
 Alameda; H.D. Bendixsen (1/4) of Eureka; P. Rice (1/8) of  
 Eureka; O.B. Hinsdale (1/16) of Gardiner, OR; and William F.  
 Jewett (1/16) of Gardiner, OR.  
 5 Feb 1895 - 2 July 1895  
 Peter Rice, Master  
 Change of owners  
 Port of San Francisco

- 23) Certificate of Enrollment (no. 1)  
 Owners same  
 2 July 1895 - 22 Aug 1896  
 Peter Rice, Master (at time of enrollment)  
 O.C. Larsen, Master, 15 Oct 1895 (atSF) Change of papers  
 Port of San Francisco
- 24) Certificate of Enrollment (no. 34)  
 Joseph Knowland (1/4), Rice dropped, others same.  
 22 Aug 1896 - 24 Nov 1896  
 O.C. Larsen, Master  
 Change of owners in part  
 Port of San Francisco
- 25) Certificate of Registry (no. 31)  
 Owners same  
 24 Nov 1896 - 8 March 1897  
 O.C. Larsen, Master  
 Change of trade  
 Port Townsend
- 26) Certificate of Enrollment (no. 167)  
 Joseph Knowland (3/16), O. Christian Larsen (1/16) of Oakland,  
 others same.  
 8 March 1897 - 16 March 1898  
 O.C. Larsen, Master  
 Change of owners in part and change of home port  
 Port of San Francisco
- 27) Certificate of Enrollment (no. 203)  
 E.C. Olsen (1/16), Larsen dropped, others same.  
 16 March 1898 - 19 April 1899  
 E.C. Olsen, Master  
 Change of owners in part  
 Port of San Francisco
- 28) Certificate of Enrollment (no. 244)  
 N.F.D. Jorgensen (1/16), Olsen dropped, others same.  
 19 April 1899 - 29 Dec 1899  
 N.F.D. Jorgensen, Master (at time of enrollment)  
 Haldor Smith, Master, 12 June 1899 (SP)  
 Change of owners in part  
 Port of San Francisco



- 29) Certificate of Registry (no. 50)  
Haldor Smith (1/16), Jorgensen dropped, others same.  
29 Dec 1899 - 19 July 1900  
Haldor Smith, Master  
Change of owners in part and change of papers  
Port of San Francisco
- 30) Certificate of Enrollment (no. 25)  
Owners same  
19 July 1900 - 28 Oct 1901  
Haldor Smith, Master  
Change of papers  
Port of San Francisco
- 31) Certificate of Enrollment (no. 112)  
Joseph Knowland (19/32), C.F. Klitgaard (1/16), dropped  
Bendixsen, Bruce, A.A. Smith, Clough, and Haldor Smith,  
others same.  
28 Oct 1901 - 10 Aug 1904  
C. Madison, Master (at time of enrollment)  
C.O. Lundbery, Master, 17 Oct 1902 -SP  
Henry Nelson, Master, 14 May 1903 -SP  
Change of owners in part  
Port of San Francisco
- 32) Certificate of Enrollment (no. 24)  
Joseph Knowland (3/8), J.R. Knowland (1/16), N.J. Cornwall  
(1/16) of Berkeley, John Hamilton (1/32) of Eureka, R.L.  
Cuzner (1/16) of LosAngeles, James Cuzner (1/16) of  
LosAngeles, and J.W. Elliot (1/32) of Los Angeles, drop  
Klitgaard, others same.  
10 Aug 1904 - 11 Nov 1905  
Henry Nelson, Master (at time of enrollment)  
E. Kallowburg(?), Master, 24 July 1905SP  
Change of owners in part  
Port of San Francisco
- 33) Certificate of Enrollment (no. 88)  
Pacific States Trading Co., of San Francisco, George E. Bennet,  
Sec.(7/8); (Joseph?) Knowland (1/8).  
11 Nov 1905 - 31 May 1909  
C. Anderson, Master (at time of enrollment)  
M.G. Kelton, Master, 12 April 1907-SF

- Change of owners  
Port of San Francisco
- 34) Certificate of Enrollment (no. 249)  
Pacific States Trading Co., Alexander Woodside, President  
31 May 1909 - 5 Jan 1910  
H.H. Hansen, Master  
Change of owners  
Port of San Francisco
- 35) Certificate of Registry (no. 26)  
Pacific States Trading Co., Alexander Woodside, President  
5 Jan 1910 - 27 April 1910  
Oscar Johnson, Master  
Change of trade  
Port of San Francisco
- 36) Certificate of Enrollment (no. 233)  
Pacific States Trading Co., Alexander Woodside, President  
27 April 1910 - 25 May 1910  
Oscar Johnson, Master  
Change of trade  
Port of San Francisco

Documents Surrendered: Los Angeles, CA, 31 May 1910

Cause of Surrender: Vessel Lost - Total Wreck, 25  
May 1910, Santa Rosa Island.

**APPENDIX B**

**Enrollment and Registration Data:  
Schooner *Comet***

Registry: 126379

Built: Port Blakely, Washington, 1886

Shipbuilder: Hall Brothers Shipyard

Ownership:

- 1) Certificate of Registry (no. 18)  
C.F.S. Lass (1/3) of Oakland; J.P. Hooper (1/3) and F.A. Hooper  
(1/3) of San Francisco  
19 Oct 1886 - 11 Nov 1886  
C.F.S. Lass, Master  
First Registration  
Port Townsend, Washington
- 2) Certificate of Enrollment (no. 76)  
Owners same  
11 Nov 1886 - 16 Sept 1889  
C.F.S. Lass, Master  
Change of home port  
Port of San Francisco
- 3) Certificate of Registry (no. 2)  
Owners same  
16 Sept 1889 - 17 Feb 1890  
George G. Lovdall, Master (at time of registry)  
William Ternstrom, Master, 17 Feb 1890SD  
Change of trade  
Port of Eureka, CA
- 4) Certificate of Enrollment (no. 6)  
Owners same  
17 Feb 1890 - 9 May 1895  
William Ternstrom, Master (at time of enrollment)  
H.P. Hallbeck, Master, 13 Dec 1893 SP  
William Ternstrom, Master, 16 Feb 1894SP  
Change of trade  
Port of San Diego
- 5) Certificate of Registry (no. 30)  
Owners same  
9 May 1895 - 11 June 1895  
William Ternstrom, Master  
Change of trade  
Port Angeles, Washington

- 6) Certificate of Enrollment (no. 16)  
 Owners same  
 11 June 1895 - 23 Feb 1905  
 William Ternstrom, Master (at time of enrollment)  
 James McVicar, Master, 13 Feb 1896 SP  
 L. Larsen, Master, 20 Dec 1896 PT  
 William Ternstrom, Master, 6 Jan 1897 SP  
 [information missing]  
 F.E. Rensch, Master, 9 June 1904 LA  
 John W. Manka, Master, 16 July 1904  
 Change of trade  
 Port of Los Angeles
- 7) Certificate of Enrollment (no. 151)  
 John A. Hooper (1/3), F.A. Hooper (1/3), C.F.S. Lass (4/15), and  
 John W. Manka (1/15).  
 23 Feb 1905 - 5 March 1907  
 Otto Lembke, Master  
 Change of owners in part and change of home port  
 Port of San Francisco
- 8) Certificate of Enrollment (no. 258)  
 John A. Hooper (8/15), Isabel Norwood (1/15), C.A. Hooper &  
 Co.(1/15), C.F.S. Lass (4/15), Otto Lembke (1/15) of Aberdeen,  
 Wash.  
 5 March 1907 - 1 March 1910  
 Otto Lembke, Master (at time of enrollment)  
 Nicolas Borgensen, Master, 28 Feb 1910SD  
 Change of owners in part  
 Port of San Francisco  
 Liscence renewed: 5 Feb 1908, Port Townsend 5 Feb 1909,  
 Port Townsend 23 Feb 1910, San Diego
- 9) Certificate of Enrollment (no. 6)  
 Nicolas Borgensen (1/15), others same.  
 1 March 1910 - 27 May 1910  
 Nicolas Borgensen, Master  
 Change of owner in part  
 Port of San Diego

- 10) Certificate of Enrollment (no. 261)  
Owners same  
27 May 1910 - 30 Aug 1911  
Nicolas Borgensen, Master  
Change of home port  
Port of San Francisco

Documents Surrendered: San Francisco, 11 Sept 1911

Cause of Surrender: Vessel Lost, Stranded on San Miguel Island, CA, 30 Aug 1911.

## **APPENDIX C**

### **Enrollment and Registration Data: Schooner *J. M. Colman***

Registry: 76717

Built: Port Blakely, Washington, 1888

Shipbuilder: Hall Brothers Shipyard

Ownership:

- 1) Certificate of Enrollment (no. 43)  
 J.J. McKinnon of San Francisco, sole owner.  
 3 May 1888 - 16 June 1888  
 C.H. Atwood, Master  
 First Enrollment  
 Port Townsend, Washington
- 2) Certificate of Enrollment (no. 43)  
 J.J. McKinnon (1/2), Preston and McKinnon (7/16), and John  
 Simpson of Sacramento (1/16).  
 16 June 1888 - 4 March 1892  
 C.H. Atwood, Master (at time of enrollment)  
 William Treanor(?), Master, 10 Nov 1890 - SF  
 Change of owners in part and change of home port  
 Port of San Francisco
- 3) Certificate of Registry (no. 84)  
 Owners same  
 4 March 1892 - 26 April 1892  
 William Treanor, Master  
 Change of papers  
 Port of San Francisco
- 4) Certificate of Enrollment (no. 233)  
 Preston and Mckinnon (5/16), William Treanor (1/8), others same.  
 26 April 1892 - 23 Feb 1894  
 William Treanor, Master  
 Change of owners in part and change of papers  
 Port of San Francisco
- 5) Certificate of Registry (no. 84)  
 Owners same  
 23 Feb 1894 - 11 Sept 1894  
 William Treanor, Master  
 Change of papers  
 Port of San Francisco



- 6) Certificate of Enrollment (no. 14)  
 Owners same  
 11 Sept 1894 - 26 Dec 1894  
 William Treanor, Master  
 Change of trade  
 Port Townsend, Washington
- 7) Certificate of Enrollment (no. 115)  
 Owners same  
 26 Dec 1894 - 28 April 1896  
 William Treanor, Master  
 Change of home port  
 Port of San Francisco
- 8) Certificate of Registry (no. 102)  
 Owners same  
 28 April 1896 - 31 Aug 1896  
 William Treanor, Master  
 Change of papers  
 Port of San Francisco
- 9) Certificate of Enrollment (no. 8-temp.)  
 Owners same  
 1 Sept 1896 - 26 Sept 1896  
 William Treanor, Master  
 Change of trade  
 Port Townsend, Washington
- 10) Certificate of Enrollment (no. 60)  
 Owners same  
 26 Sept 1896 - 15 Jan 1897  
 William Treanor, Master  
 Change of home port  
 Port of San Francisco
- 11) Certificate of Enrollment (no. 120)  
 J.J. McKinnon (1/4), W.J. Tibbets (1/8), C.A. Hooper (1/8), Puget  
 Sound Commercial Co. (Inc.) of Port Gamble (3/16), A.C.  
 Freese (1/8), Preston and McKinnon dropped, others same.  
 15 Jan 1897 - 1 Feb 1897  
 William Treanor, Master  
 Change of owners in part  
 Port of San Francisco

- 12) Certificate of Registry (no. 7)  
Owners same  
1 Feb 1897 - 27 April 1897  
William Treanor, Master  
Change of trade  
Port of Portland, Oregon
- 13) Certificate of Enrollment (no. 50)  
Owners same  
27 April 1897 - 5 June 1897  
William Treanor, Master  
Change of trade  
Port Townsend, Washington
- 14) Certificate of Enrollment (no. 267)  
Owners same  
5 June 1897 - 2 Dec 1897  
William Treanor, Master  
Change of home port  
Port of San Francisco
- 15) Certificate of Registry (no. 44)  
Owners same  
2 Dec 1897 - 8 Feb 1898  
William Treanor, Master  
Change of papers  
Port of San Francisco
- 16) Certificate of Enrollment (no. 164)  
Owners same  
8 Feb 1898 - 2 May 1899  
William Treanor, Master  
Change of papers  
Port of San Francisco
- 17) Certificate of Registry (no. 184)  
Owners same  
2 May 1899 - 22 Aug 1899  
William Treanor, Master (at time of registry)  
Murchison (first initial unknown), Master, 15 May 1899 at New  
Whatcam, Puget Sound  
Change of trade  
Port Angeles, Washington

- 18) Certificate of Enrollment (no. 30)  
Owners same  
22 Aug 1899 - 26 Sept 1899  
Murchison (?), Master  
Change of trade and tonnage  
Port Townsend, Washington
- 19) Certificate of Registry (no. 16)  
Mrs. Julia Simpson (1/16), James M. Coleman (1/4),  
J.J. McKinnon and John Simpson dropped, others same.  
26 Sept 1899 - 3 April 1900  
Murchison (?), Master  
Change of owners in part and change of home port  
Port of San Francisco
- 20) Certificate of Enrollment (no. 62B)  
Owners same  
7 April 1900 - 13 May 1900  
Murchison, Master (at time of enrollment)  
O. Lindholm, Master, 11 April 1900 at Seattle  
Change of trade  
Port of Seattle
- 21) Certificate of Enrollment (no. 313)  
Owners same  
16 May 1900 - 23 Oct 1900  
Lindholm, Master (at time of enrollment)  
Peter Johnson, Master, 21 August 1900 at Tacoma  
Charles Peterson, Master 31 August 1900 at Tacoma  
Change of home port  
Port of San Francisco
- 22) Certificate of Registry (no. 5)  
Owners same  
23 Oct 1900 - 27 June 1901  
Charles Peterson, Master  
Change of trade  
Port of Eureka, California

- 23) Certificate of Registry (no. 96)  
Pacific Shipping Co. of San Francisco,  
E.H. Burnell of Alameda, Secretary  
27 June 1901 - 28 Sept 1901  
Charles Peterson, Master  
Change of owners and home port  
Port of San Francisco
  
- 24) Certificate of Enrollment (no. 60)  
Owners same  
28 Sept 1901 - 20 Jan 1902  
Charles Peterson, Master  
Change of trade  
Port Townsend, Washington
  
- 25) Certificate of Enrollment (no. 189)  
Owners same  
20 Jan 1902 - 24 March 1903  
Charles Peterson, Master  
Change of home port  
Port of San Francisco
  
- 26) Certificate of Enrollment (no. 219)  
Pacific Shipping Co. of San Francisco,  
H.O. Beatty of San Francisco, Secretary  
24 March 1903 - 4 Oct 1905  
Charles Peterson, Master  
Change of officer  
Port of San Francisco

Documents Surrendered: Los Angeles, CA, 4 Oct 1905

Cause of Surrender: Vessel Wrecked - Total Loss

# **SUBMERGED RESOURCES CENTER REPORT AND PUBLICATION SERIES**

---

The Submerged Cultural Resources Unit was established in 1980 to conduct research on submerged cultural resources throughout the National Park System with an emphasis on historic shipwrecks. One of the unit's primary responsibilities is to disseminate the results of research to National Park Service managers, as well as the professional community. A report series has been initiated in order to fulfill this responsibility. It has been incorporated into an umbrella series entitled Southwest Cultural Resources Center and Intermountain Cultural Resource Centers Professional Papers. The following are the categories:

## **SUBMERGED CULTURAL RESOURCES ASSESSMENT**

First line document that consists of a brief literature search, an overview of the maritime history and the known or potential underwater sites in the park, and preliminary recommendations for long-term management. It is designed to have immediate application to protection and interpretation needs and to become a source document for a park's Submerged Cultural Resources Management Plan.

## **SUBMERGED CULTURAL RESOURCES SURVEY**

Comprehensive examination of blocks of park lands for the purpose of locating and identifying as much of the submerged cultural resources base as possible. A comprehensive literature

search would most likely be a part of the Phase I report but, in some cases, may be postponed until Phase II.

Phase I — Reconnaissance of target areas with remote sensing and visual survey techniques to establish location of any archeological sites or anomalous features that may suggest the presence of archeological sites.

Phase II — Evaluation of archeological sites or anomalous features derived from remote-sensing instruments to confirm their nature, and if possible, their significance. This may involve exploratory removal of overburden.

## **SUBMERGED CULTURAL RESOURCES STUDY**

A document that discusses, in detail, all known underwater archeological sites in a given park. This may involve test excavations. The intended audience is managerial and professional, not the general public.

## **SUBMERGED CULTURAL RESOURCES SITE REPORT**

Exhaustive documentation of one archeological site which may involve a partial or complete site excavation. The intended audience is primarily professional and incidentally managerial. Although the document may be useful to a park's interpretive specialists because of its information content, it would probably not be suitable for general distribution to park visitors.

## SUBMERGED CULTURAL RESOURCES SPECIAL REPORT

These may be in published or photocopy format. Included are special commentaries, papers on methodological or technical issues pertinent to underwater archeology, or any miscellaneous report that does not appropriately fit into one of the other categories.

## SUBMERGED RESOURCES CENTER PROFESSIONAL REPORTS

1. Daniel J. Lenihan, Toni L. Carrell, Stephen Fosberg, Larry Murphy, Sandra L. Rayl and John A. Ware. *Final Report of the National Reservoir Inundation Study*. Two volumes. Submerged Cultural Resources Unit, 1981.
2. Larry E. Murphy, Editor. *Submerged Cultural Resources Survey: Portions of Point Reyes National Seashore and Point Reyes-Farallon Islands National Marine Sanctuary*. Submerged Cultural Resources Unit, 1984. Originally published as Southwest Cultural Resources Center Professional Papers #1.
3. Toni Carrell. *Submerged Cultural Resources Inventory: Portions of Point Reyes National Seashore and Point Reyes-Farallon Islands National Marine Sanctuary*. Submerged Cultural Resources Unit, 1984. Originally published as Southwest Cultural Resources Center Professional Papers #2.
4. Toni Carrell. *Submerged Cultural Resources Site Report: NOQUEBAY, Apostle Islands National Lakeshore*. Submerged Cultural Resources Unit, 1985. Originally published as Southwest Cultural Resources Center Professional Papers #7.
5. Daniel J. Lenihan, Editor. *Submerged Cultural Resources Study: Isle Royale National Park*. Submerged Cultural Resources Unit, 1987. Originally published as Southwest Cultural Resources Center Professional Papers #8.
6. Toni Carrell, Editor. *Submerged Cultural Resources Site Report: Charles H. Spencer Mining Operation and Paddle Wheel Steamboat, Glen Canyon National Recreation Area*. Submerged Cultural Resources Unit, 1987. Originally published as Southwest Cultural Resources Center Professional Papers #13.
7. James P. Delgado and Stephen A. Haller. *Submerged Cultural Resources Assessment: Golden Gate National Recreation Area, Gulf of the Farallones National Marine Sanctuary and Point Reyes National Seashore*. Submerged Cultural Resources Unit, 1989. Originally published as Southwest Cultural Resources Center Professional Papers #18.
8. C. Patrick Labadie. *Submerged Cultural Resources Study: Pictured Rocks National Lakeshore*. Submerged Cultural Resources Unit, 1989. Originally published as Southwest Cultural Resources Center Professional Papers #22.
9. Daniel J. Lenihan, Editor. *Submerged Cultural Resources Study: USS Arizona Memorial and Pearl Harbor National Historic Landmark*. Submerged Cultural Resources Unit, 1989. Originally published as Southwest Cultural Resources Center Professional Papers #23.
10. Toni L. Carrell, Editor. *Submerged Cultural Resources Assessment of Micronesia*. Submerged Cultural Resources Unit, 1991. Originally published as Southwest Cultural Resources Center Professional Papers #36.

11. James P. Delgado, Daniel J. Lenihan and Larry Murphy. *The Archeology of the Atomic Bomb: A Submerged Cultural Resources Assessment of the Sunken Fleet of Operation Crossroads at Bikini and Kwajalein Atoll Lagoons, Republic of the Marshall Islands*. Submerged Cultural Resources Unit, 1991. Originally published as Southwest Cultural Resources Center Professional Papers #37.
12. Larry E. Murphy. *8SL17: Natural Site-Formation Processes of a Multiple-Component Underwater Site in Florida*. Submerged Cultural Resources Unit, 1990. Originally published as Southwest Cultural Resources Center Professional Papers #39.
13. Larry Murphy, Editor. *Dry Tortugas National Park, Submerged Cultural Resources Assessment*. Submerged Cultural Resources Unit, 1993. Originally published as Southwest Cultural Resources Center Professional Papers #45.
14. Don Morris and James Lima. *Channel Islands National Park and Channel Islands National Marine Sanctuary, Submerged Cultural Resources Assessment*. Submerged Cultural Resources Unit, 1996. Originally published as Intermountain Cultural Resource Centers Professional Papers #56.
15. Larry E. Murphy, Editor. *H.L. Hunley Site Assessment*. Submerged Cultural Resources Unit, 1998. Originally published as Cultural Resources Management Professional Papers #62.
16. James E. Bradford, Matthew A. Russell, Larry E. Murphy and Timothy G. Smith. *Yellowstone National Park Submerged Resources Survey*. Submerged Resources Center, 2003. Cultural Resources Management Professional Papers #65.
17. Matthew A. Russell. *Comet Submerged Cultural Resources Site Report*. Submerged Resources Center, 2004.
18. Matthew A. Russell. *Beached Shipwreck Archeology: Case Studies from Channel Islands National Park*. Submerged Resources Center, 2005.

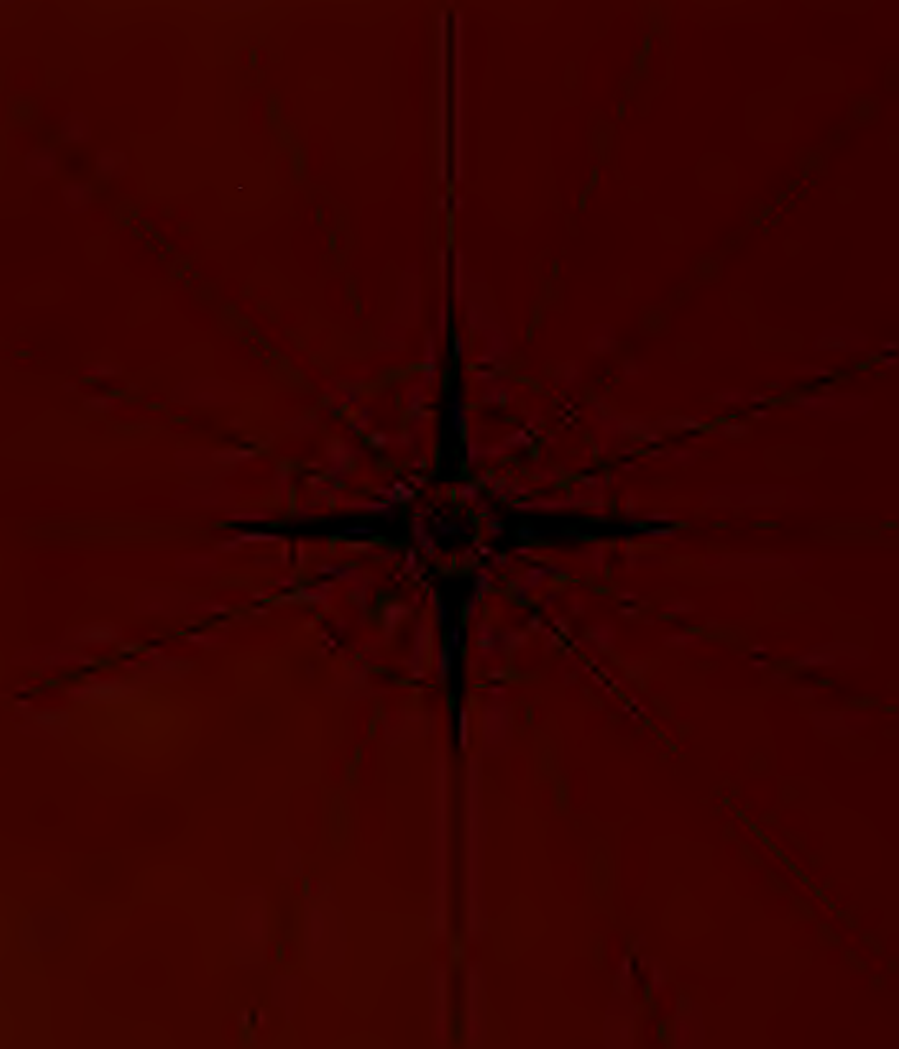
Mission: As the Nation's principal conservation agency, the Department of the Interior has responsibility for most of our nationally-owned public lands and natural and cultural resources. This includes fostering wise use of our land and water resources, protecting our fish and wildlife, preserving the environmental and cultural values of our national parks and historical places, and providing for the enjoyment of life through outdoor recreation. The Department assesses our energy and mineral resources and work to assure that their development is in the best interests of all our people. The Department also promotes the goals of the Take Pride in America campaign by encouraging stewardship and citizen responsibility for the public lands and promoting citizen participation in their care. The Department also has a major responsibility for American Indian reservation communities and for people who live in Island Territories under US Administration.





National Park Service  
U.S. Department of the Interior

Submerged Resources Center



The National Park Service cares for special places saved by the American people so that all may experience our heritage.