









Digitized by the Internet Archive  
in 2013

<http://archive.org/details/researchnote15inte>







# Research Note

UNITED STATES DEPARTMENT OF AGRICULTURE  
FOREST SERVICE

INTERMOUNTAIN FOREST & RANGE EXPERIMENT STATION  
OGDEN UTAH

U.S. Forest Service  
Research Note INT-1

1963

## EFFECT OF SEVERE RAINSTORMS ON INSLOPED AND OUTSLOPED ROADS

H. F. Haupt, H. C. Rickard, and L. E. Finn<sup>1</sup>

### ABSTRACT

Three heavy rainstorms that produced from about 7.5 to 10.0 inches of rain in central Idaho in a 10-day period in October 1962, caused considerable damage to newly constructed logging roads. Insloping a roadbed under the time, topographic, soil, and storm conditions described is more desirable than outsloping as a measure for preventing erosion and damage to the roads.

### INTRODUCTION

In central Idaho forests of the Intermountain Region, secondary or infrequently used logging roads are "put-to-bed" after completion of timber harvest operations as prescribed by Forest Service policy. This treatment usually involves (a) removing all temporary culverts, (b) outsloping the road surface and removing berms, (c) installing earthen cross drains at proper intervals, and (d) seeding the road surface, cut banks, and fill slopes. An empirical guide for proper spacing of cross drains has been developed and published.<sup>2</sup> Soil stability has been improved by using these erosion control measures on roads constructed on moderate to steeply sloping terrain.<sup>3</sup>

<sup>1</sup> Project leader, watershed management research, Intermountain Forest and Range Experiment Station, Boise, Idaho; resident engineer and resident forester, respectively, Zena Creek logging study, Payette National Forest, McCall, Idaho.

<sup>2</sup> Haupt, H. F. A method for controlling sediment from logging roads. U.S. Forest Serv. Intermountain Forest and Range Expt. Sta. Misc. Pub. 22, 22 pp. 1959.

<sup>3</sup> Haupt, H. F., and W. J. Kidd, Jr. Effects of logging disturbance on sediment production from a virgin ponderosa pine forest. 1963. (In preparation, Intermountain Forest and Range Experiment Station.)

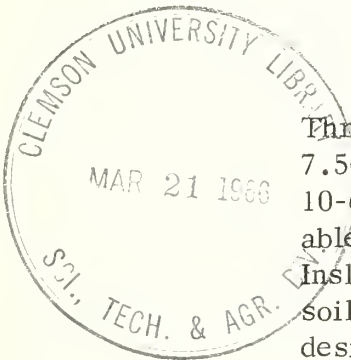

Preventing erosion on soils derived from granite becomes more critical and difficult as logging is extended from moderate slopes to more rugged terrain where slope gradients often exceed 60 percent. Here, roadbeds must be partially or entirely "benched" on rock that requires deep cuts and consequently produces a surplus of road material. This material is usually castover and comes to rest in long unstable fills that may extend for 100 feet or more down a ravine on the "incurve" section of a road. These fills are generally shorter on the side slope below the "outcurve" section.

In recent years, land managers have questioned the erosion-prevention practice of draining these precariously situated roads by outsloping and removing berms, and then installing earthen cross drains on incurves, particularly at intersections with swales. An alternative--that the roadbed be insloped and water prevented from flowing onto the fill except at selected points--has been advocated.

### THE STUDY

Both concepts of road drainage were evaluated on a newly built, secondary logging road on the Zena Creek logging study, Payette National Forest. The road, constructed in June 1962, traverses a steep mountain slope with gradients generally exceeding 60 percent. The slope is broken by numerous ravines and swales, and its general aspects are west and southwest.

The shallow, very coarse sandy soils above the road were categorized into three major soil units, Nos. 2, 8, and 3.<sup>4</sup> Soil unit No. 2 varies in depth to bedrock from 6 to 20 inches and occupies the ridges and side slopes; unit No. 8 may be as deep as 48 inches and characteristically occupies the swales; unit No. 3 contains granite rock outcropping amounting to 10 to 25 percent areawise. The soil of the latter unit, usually less than 12 inches deep, overlies relatively hard granite bedrock and usually occurs on slopes greater than 70 percent. Vegetation consists mainly of sparsely stocked ponderosa pine with little or no understory.

The postlogging treatment applied to portions of the road included outsloping with frequent earthen cross drains spaced from 30 to 90 feet apart. The angle of outsloping was staked to a minimum of 5 percent or equal to the road gradient if greater than 5 percent, but not exceeding the maximum road gradient measured, which was 7 percent. The same treatment was applied to the insloped sections of road, except that on the insloped road some earthen cross drains were eliminated on incurves opposite swales. Insloping refers to uniform sloping of the road from outside to inside with no inside ditch.

---

<sup>4</sup>Olson, O. C. Soils of the Zena Creek Logging Study, Payette National Forest, Region 4. 1960. (Unpublished soils report on file at Intermountain Region, U.S. Forest Service, Ogden, Utah.)



Culverts were installed "on original water grade" in major ravines and the road-bed for about 300 feet immediately above was insloped to drain water to the culvert. This practice of installing culverts was applied to both the outsloped and insloped sections of the road.

Finally, the road shoulders and fill slopes were seeded with a grass mixture in September and covered with chopped hay and asphalt binder (fig. 1-A). A short section of fill slope along the insloped road was reserved for plots on which to study methods of establishing plant cover.



Figure 1.--Outsloped section of study road, cross ditched and mulched: A, prior to the October 1962 rainstorms; B, following the October 1962 storms.

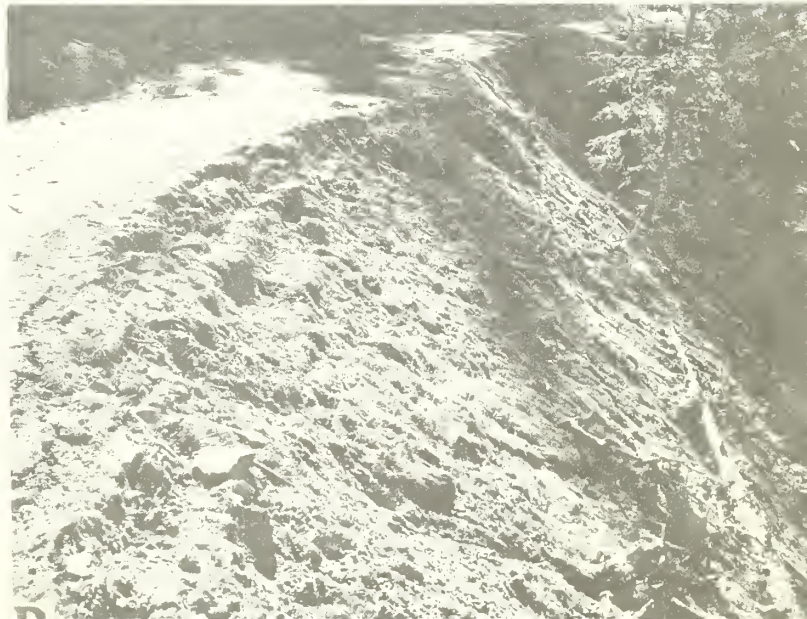

## RAINSTORM HISTORY

September 1 to October 5.--From September 1 to October 5, 1962, rainfall in the vicinity of the study road, situated approximately one-half mile between the Deep Creek and Secesh Camp rain gage stations, was estimated at 1.25 inches. Most of it fell sporadically and evaporated shortly after falling. Therefore, at the advent of the October 6 to 15 rainstorms the soil mantle was essentially dry.

October 6 to 15.--Three low intensity rainstorms of 8-, 38-, and 87-hour duration, occurred in rapid succession within a period of 10 days in the Zena Creek logging study area. Rainfall produced by these storms was measured in four recording gages. Total rainfall varied from 7.60 inches to 9.99 inches (table 1). Intensity of the rainfall did not exceed 0.48 inch per hour for any 10-minute period nor 0.20 inch for any given hour.

Table 1.--Rainfall at five rain gage stations in central Idaho for  
October 6 to 15, 1962

Date	Zena Creek area rain gage stations <sup>1</sup>				
	Circle End Creek	Oompaul Creek	Deep Creek	Secesh Camp	McCall station <sup>2</sup>
	Elev. 4, 100'	Elev. 5, 000'	Elev. 5, 060'	Elev. 4, 220'	Elev. 5, 020'
	----- Inches -----				
6	0.03	0.00	0.02	0.00	0.00
7	.58	.63	.37	.64	.06
8	.28	.34	.33	.30	.38
9	1.67	1.66	1.20	1.29	.58
10	1.45	1.30	1.45	1.51	1.03
11	1.27	1.40	1.19	1.07	.30
12	1.33	1.32	1.10	1.14	1.83
13	1.40	1.36	.86	1.05	<sup>3</sup> .70
14	.43	1.83	1.01	1.04	<sup>3</sup> 1.25
15	.02	.15	.07	.05	.32
Total	8.46	9.99	7.60	8.09	6.45

<sup>1</sup> Recording gages.

<sup>2</sup> Nonrecording gage.

<sup>3</sup> Included a trace of snowfall.

To determine whether this rainfall established a record high, storm characteristics for the same period were examined at the nearest U.S. Weather Bureau station in McCall, Idaho, located 21 miles southwest of the study area (table 1). This station started in 1905 and has been operated continuously except from 1910 to 1916. Records indicated that the 8 consecutive days of rain in October 1962 were the wettest in the history of record.<sup>5</sup> By inference, the storms which struck the study area road were unprecedented relative to total rainfall.

Precipitation from the October storms produced in a few days a condition that normally develops over a period of several months on watersheds having shallow soils. During a usual autumn, rains partially recharge the soil mantle; this process continues through late winter as the snowpack melts. By early spring, seepage flow commences and streams begin to rise slowly. Unlike the usual spring runoff, a tremendous surge of seepage flow that caused high peaks in local streams was generated by the steady rainfall that occurred during the third storm, whose duration was 87 hours.

The most recent storm period in central Idaho having similar characteristics was December 18 to 23, 1955.<sup>6</sup> The record-breaking rain-on-snow floods of that period were more widespread but were generated by less rainfall than that during the period October 6 to 15, 1962; however, the McCall weather data show that the 1955 event was preceded by considerable antecedent rain and snow. As a result, streamflow peaks reached higher levels than in October 1962.

#### SEEPAGE FLOW, CHANNEL FLOW, SLOUGH, AND EROSION ON THE SECONDARY LOGGING ROAD

The thin, porous soil mantle above the road being studied was saturated early in the storm period. Because these soils have rapid internal drainage,<sup>7</sup> undoubtedly a substantial portion of the 7 to 9 inches or more of rainfall moved through the soil and over the bedrock as subsurface flow. No evidence was found of overland flow having originated on the surface of the forest floor. Swales, heretofore dry, produced channel flow or emitted subsurface flow directly at the face of the road cut bank. Two days after the last storm, water was observed dripping from beneath the very shallow mantle in contact with unfractured bedrock. A few swales continued to produce seepage flow for 3 rainless weeks following the storms.

---

<sup>5</sup>U.S. Weather Bureau. McCall, Idaho weather station original field forms (archives), Municipal Airport, Boise, Idaho. 1906. (Data on file at the State Archives, Municipal Airport, Boise, Idaho, U.S. Weather Bureau.)

<sup>6</sup>U.S. Weather Bureau. Climatological data, Idaho 58(12): 156-157. 1955.

<sup>7</sup>See footnote 4, page 2.

The road profile, having been subjected to almost steady rainfall for about 10 days and to channel-derived and subsurface flows, became saturated, and large expanses of the fill portion of the road prism slumped and eroded, irrespective of the mechanical systems of drainage applied. Surprisingly, culverts functioned without plugging. Vertical displacement of soil was generally confined to the fill slope, which at some places inclined 90 percent. Laboratory analyses revealed that the clay or aggregating constituent of fill material was less than 4 percent by weight.<sup>8</sup>

### DAMAGE TO OUTSLOPED ROAD

Where the road was outsloped, damage from erosion and slough decreased the usable width of roadbeds. Greatest damage occurred at the mouth of swales on the incurve (fig. 2). This was caused by the concentration of subsurface flow as well as by surface flow at these points along the road. An incurve usually has a higher proportion of fill material to solid bench; therefore it is inherently more unstable when saturated.

All outlets of earthen cross drains were deeply eroded. Observations along the road where surface water spilled over the edge, other than at a cross drain, indicated that further wetting caused slough and erosion on the fill slope proper (fig. 1-B). Particularly on an incurve, surface and seepage flows were literally funneled onto the fill material and caused severe damage. Mud-rock flows, set in motion on the fill, moved several hundred feet further down the ravine. One flow moved 850 feet downslope to a lower road.

---

<sup>8</sup>U.S. Forest Service. Soil stabilization project, Intermountain Forest and Range Experiment Station. 1962. (Data on file at the Boise, Idaho field office of the Intermountain Forest and Range Experiment Station, U.S. Forest Service.)



Figure 2.--Outsloped section of study road opposite slight swales. Note wet dark soil on cut bank caused by seepage.

## DAMAGE TO INSLOPED ROAD

Damage to the bed of the insloped road from erosive cutting was slight. The lateral flow of water confined to the inside of the roadway was incapable of cutting into the solid bench of the road. Although slough from the cut bank above could have blocked the flow of water, it was negligible on this road because of the predominance of exposed rock and shallowness of soils (fig. 3). Blocking of inside drainage by accumulated slough has often been postulated as a disadvantage of insloping.

Surface water overtopped the angle of the inslope only where it was diverted from the roadbed by an earthen cross drain. At those points erosion damage to the fill even on an outcurve was severe because of the large volume of storm runoff. However, the undisturbed side slope below an outcurve tended to absorb the storm runoff and slowed the movement of sediment flows before they reached a ravine or stream. Past observations on similar soils on the Boise National Forest showed that side slope obstructions such as brush, logging slash, rocks, standing trees, and stumps effectively retarded sediment flows.<sup>9</sup>

Damage to the fill of the insloped road, other than at an earthen cross drain, although fairly widespread, was less serious than on the outsloped road. Considerable slumping below the edge of the roadbed resulted from the intercepted rainfall and subsurface flow. The effect of subsurface flow in causing slumping was very pronounced where the road crossed a swale. Quite by accident, it was possible to isolate and observe this relative effect on the section of road set aside for plot studies. Steel plot frames located on the fill slope on the incurves were displaced downhill or obliterated

---

<sup>9</sup> Haupt, H. F. Road and slope characteristics affecting sediment movement from logging roads. Jour. Forestry 57: 329-332, illus. 1959.

Figure 3.--Insloped section of road with low berm, following the October 1962 storms. The inside of the road is relatively free of slough.



by intensive slumping; those installed on the outcurves were displaced only slightly because of minor slumping (fig. 4). These observations further point up the vulnerability of the fill portion of incurves.

### IMPLICATIONS

Two erosion prevention practices, insloping and outsloping, were evaluated on a secondary logging road that (a) had been in existence less than 6 months, (b) traversed a steep mountain with slopes generally exceeding 60-percent gradient, and (c) left exposed, in most instances, an 8- to 14-foot cut bank of granite rock overlain by a shallow soil, generally less than 20 inches deep.

Observations indicate that insloping a roadbed of the type described above, before this severe long-duration rainstorm, is more desirable than outsloping as a measure for preventing erosion. Specifically, the inslope should be designed to lead as much storm runoff as possible away from the long fill on the incurve of the road. Where culverts are to be used in major ravines, they should be located on the original water grade so that they do not discharge on the fill of the incurve but drain into the original channel. Where earthen cross drains are to be used, they should be located to discharge their flows on the outcurve of the road. Below the outcurve the undisturbed side slope will tend to absorb road drainage and retard sediment flows before they reach a ravine or stream.

Even with the best design of road drainage, erosion damage may be expected following as heavy rainfall as occurred between October 6 and 15, 1962.



Figure 4.--Appearance of an insloped section of road set aside for plot studies following the October 1962 storms. Arrows locate plot frames displaced from original position on incurves. Other plot frames remain nearly intact on outcurves.



# Research Note

UNITED STATES DEPARTMENT OF AGRICULTURE  
FOREST SERVICE

INTERMOUNTAIN FOREST & RANGE EXPERIMENT STATION  
OGDEN UTAH

U.S. Forest Service  
Research Note INT-2

1963

LABORATORY METHODS FOR DETERMINING THE  
DOWNWARD MOVEMENT OF SEED ON ROAD FILLS

H. F. Haupt and W. J. Kidd, Jr.<sup>1</sup>

ABSTRACT

Attempts to seed fill slopes of newly constructed roads often fail because seed is not retained on the hardened, compacted, crusted surfaces of the fills. Model "road fill slopes" were set up in the laboratory to test several soil surface treatments for arresting downward movement of broadcast seed. Results of this study suggest that seeding upon a mulch already in place, "pockmarking" the soil surface, wetting the soil surface, and spreading wetted seed, reduce seed dispersion.

INTRODUCTION

Road construction on soils derived from the granite batholith in central Idaho usually commences as soon as snow melts in the spring and continues until the following late fall or early winter, when snow stops the operation. After road construction, raw exposed road fill of granitic origin undergoes numerous physical changes. For instance, its surface usually crusts over and becomes hard and compacted. By September or October, when the weather becomes favorable for seeding for erosion control, seed broadcast on the fill literally bounce off the crusted surface and onto the undisturbed forest floor below. Consequently, very few seed may be left on the road fill to germinate and produce the desired protective cover.

---

<sup>1</sup>Research foresters, watershed management research, Intermountain Forest and Range Experiment Station, Boise, Idaho.

This phenomenon of seed displacement may be one cause for the erratic establishment of grass and other vegetation on mountain road fill slopes. To study this particular facet of the problem, model road fill slopes were set up in the laboratory for testing various methods for arresting the downward movement of broadcast seed.

## METHODS

Four wooden boxes, each 2 by 2 feet in size, were filled with thoroughly mixed, fresh road fill of granitic origin and moved to the laboratory. Each box was then elevated at one end to simulate a road fill having a 70-percent slope. A uniform crusted surface was obtained by smoothing and spraying the fill material with water, and then air-drying for several days prior to each treatment.

Five different soil conditions were tested for ability to retain seed: the soil surface crusted and dry (control), the surface moistened, the surface "pockmarked" with holes at a density of four per square foot (fig. 1), and the surface covered with two kinds of mulch--unchopped timothy hay and narrow-mesh paper netting.<sup>2</sup> Additional combinations and variations of these treatments were also tested; e.g., the soil surface was moistened after being covered with paper netting (fig. 2A); and moistening the seed instead of the soil prior to seeding. The test of seed retention was replicated twice on the four boxes, for a total of eight observations per simulated fill slope condition.



Figure 1.--Fill slope treatment of surface holes on dry, crusted surfaces.

---

<sup>2</sup> The authors are indebted to Bemis Bros. Bag Co., St. Louis, Mo., for furnishing the material for experimental testing.



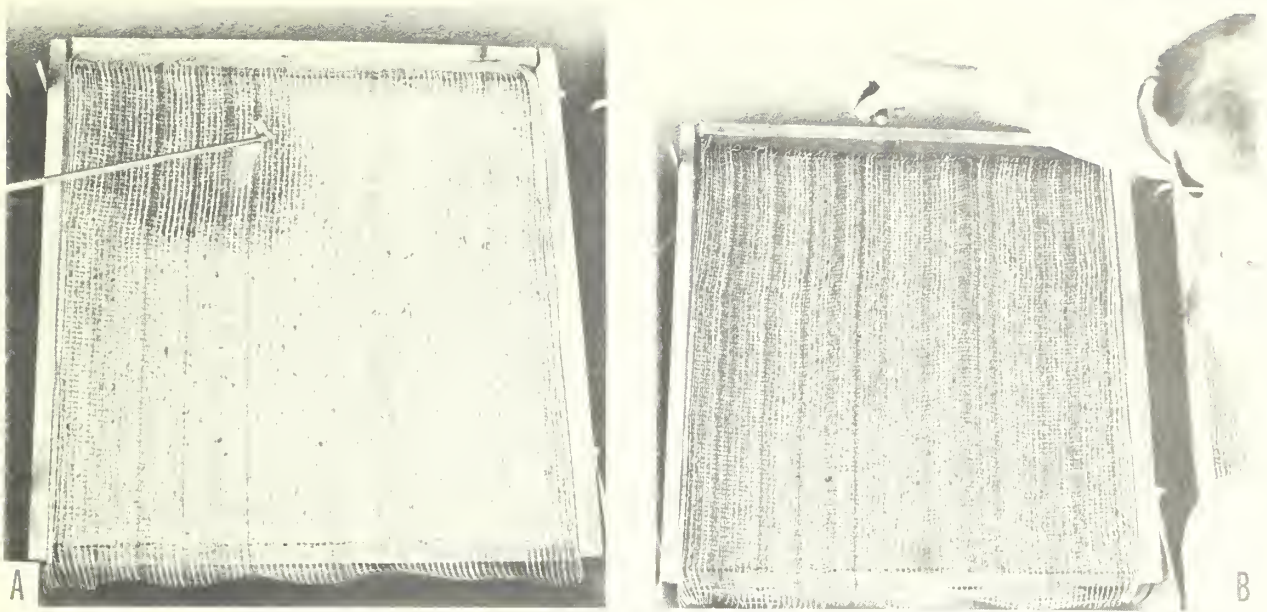

Figure 2.--Fill slope treatment of mulching with paper netting: A, sprayed with water; B, applying dry seed.

For each test of seed retention on the simulated fill slopes, a mixture of 100 seeds of each of four adaptable species--cereal rye (Secale cereale), yellow sweet-clover (Melilotus officinalis), intermediate wheatgrass (Agropyron intermedium), and smooth bromegrass (Bromus inermis)--was broadcast on each box. To maintain uniformity, the seeds were dropped by hand across the top of the box, 6 inches above the treated surface and 2 to 3 inches below the top edge of the box (fig. 2B).

Displaced or nonretained seeds (those that fell over the bottom lip of the box) were trapped in kraft paper troughs tacked below the lip. Seeds of each species caught in the trough were subtracted from 100 to give the number of seeds retained on the fill slope surface in a box. Seeds retained then became the index for judging the relative efficiency of fill slope surface treatments.

As a sidelight, counts were made of seeds applied on unchopped timothy hay and chopped hay with asphalt binder to determine the initial number of seeds trapped within the hay mulch. These results are discussed later under effect of mulching.

The data on seed retention were examined statistically by an analysis of variance with the inclusion of Duncan's multiple range test<sup>3</sup> for discriminating between means.

<sup>3</sup>Duncan, D. B. Multiple range and multiple F tests. Biometrics 11: 1-42. 1955.

## VARIATIONS IN SEED RETENTION

Analysis of the data confirmed the observation that fewer cereal rye and yellow sweetclover seeds were retained on the simulated road fills than were seeds of intermediate wheatgrass and smooth brome grass, irrespective of soil surface treatment.

The physical characteristics of both types of seed account for these differences. Cereal rye and yellow sweetclover seed are very firm, generally rounded in shape, free of lemma or pod, and relatively short, as shown in the tabulation below. These streamlined, hard seeds readily bounce off steep, compacted surfaces. On the other hand, the seeds of intermediate wheatgrass and smooth brome grass have greater overall length because they usually remain attached to a lemma (see tabulation below). The lemma has flat surfaces and irregular edges that reduce bouncing or sliding.

<u>Seed</u>	<u>Length</u> <sup>1</sup> (mm)
Cereal rye . . . . .	5.8
Yellow sweetclover . . . . .	2.0
Intermediate wheatgrass . . . . .	8.5
Smooth brome grass . . . . .	7.7

---

<sup>1</sup> Average of 10 seeds or seed-filled lemmas of each species.

On the basis of these results, the seed retention data were separated and analyzed as two distinct statistical populations.

### SEED RETENTION ON DRY, CRUSTED SOIL SURFACES

Hard, rounded seed.--Less than one-fourth of the hard, rounded seed of cereal rye and yellow sweetclover were retained in soil boxes under the control surface condition of dry, crusted soil (table 1). Seed moved with great ease either by bouncing, sliding, or rolling on the crusted surfaces that were relatively free of small rock protrusions and miniature depressions.

Elongated, flat seed.--Almost  $3\frac{1}{2}$  times as many elongated, flat seed of intermediate wheatgrass and smooth brome grass were retained as were the rounded seed.

Table 1.--Effect of different fill slope surface conditions and seed treatments on the downward movement of hard, rounded seed and elongated, flat seed

Fill slope and seed treatments	Seed retained--mean <sup>1</sup>		Statistical significance <sup>2</sup>	
	Hard, rounded	Elongated, flat	Hard, rounded	Elongated, flat
	-----Percent-----			
Dry soil, unchopped timothy hay, dry seed	99.9	100.0	a	a
Wet soil surface holes, wet paper netting, dry seed	96.8	99.4	ab	ab
Wet soil, wet paper netting, dry seed	96.6	99.4	ab	ab
Dry soil, dry paper netting, dry seed	92.8	98.4	bc	abc
Dry soil, surface holes, dry seed	91.5	99.4	c	ab
Wet soil, surface holes, dry seed	74.2	97.1	d	bc
Dry soil, wet seed	72.9	93.1	d	d
Wet soil, dry seed	43.0	96.3	e	c
Dry soil, dry seed (control)	23.6	80.9	f	e

<sup>1</sup> Out of a possible 200 seeds, replicated eight times.

<sup>2</sup> Means followed by letter "a" are significantly different from those means not having "a"; those followed by "b" are significantly different from those not having "b," etc.

### SEED RETENTION AFTER MODIFYING SOIL AND SEED SURFACES

Hard, rounded seed.--By softening the crusted fill slope surfaces with water, the number of seeds retained over the control increased almost twofold; or by applying wet seed (similar to a Hydro-seeder operation), the advantage was nearly threefold (table 1).

Pockmarking the fill slope surfaces with the end of a shovel handle further improved the retention capabilities by creating small depressions or seed traps. Interestingly, the dry soil condition with surface holes, which resulted in 91.5 percent seed retention, was significantly better than wet soil with surface holes, which retained only 74.2 percent. This unexpected increase under dry soil conditions is attributed to the shattering effect of the holes in the surrounding soil which left cracks in the crust and raised lumps of soil that caused seed to lodge (fig. 1). On the wet, softened soil surfaces, the holes were smooth punctures that did not create rough interspaces for trapping additional seed.

Elongated, flat seed.--An increase was observed in the number of seeds retained in nearly the same order of the superimposed treatments (table 1). Each modification of the soil surface increased seed retention to well over 90 percent.

## EFFECTS OF MULCHING ON RETENTION

Hard, rounded seed.--A single covering of paper netting on the dry soil (control) surfaces increased retention almost fourfold, denoting the pronounced effect that single strands of woven paper have in trapping falling seed. The additional slope treatments of surface holes and wetting further improved the mean percentages of seed retention, but the differences are not significant (table 1).

A slope surface covering of unchopped timothy hay mulch was the most effective method of checking seed displacement. Only two of the 1,600 hard, rounded seed broadcast on the mulch were displaced; movement of seed downslope under this surface treatment is negligible.

Tests conducted separately from the main study showed that broadcast seeds do not initially penetrate the unchopped hay mulch 100 percent. As expected, the amount of penetration varies to some degree with species. Seeds of smooth brome grass, cereal rye, and intermediate wheatgrass had fall-through percentages of 41.3, 45.3, and 46.7 percent, respectively. Seeds of yellow sweetclover had the highest fall-through percentage, 63.6 percent, which is significantly greater than that for the other species (table 2).

A similar relation existed for broadcast seeds on chopped hay mulch with asphalt binder, except that the overall percentages were considerably less (table 2). Seeds readily sifted through the asphalt-free hay; contrariwise, they easily adhered to the tacky asphalt binder in the chopped hay.

Table 2.--Initial penetration of broadcast seeds, by species, on unchopped timothy hay mulch and chopped timothy hay mulch-asphalt binder

Species	Seed penetration--mean <sup>1</sup>		Statistical significance <sup>2</sup>
	Unchopped hay	Chopped hay--asphalt binder	
	-----Percent-----		
Yellow sweetclover	63.6	52.6	a
Intermediate wheatgrass	46.7	16.1	b
Cereal rye	45.3	23.1	b
Smooth brome grass	41.3	18.1	b

<sup>1</sup> Out of a possible 100 seeds, replicated eight times.

<sup>2</sup> Mean followed by letter "a" is significantly different from those means not having "a"; and those followed by "b" are significantly different from the mean not having "b."

Elongated, flat seed.--The unchopped timothy hay and paper mulches, including surface holes and wetting, were highly effective in retaining seed. A small, non-significant percentage of 1.6 separated the lowest and the highest retention by treatments of this group (table 1). The treatment with the highest retention percentage was unchopped hay on dry soil.

## APPLICATION OF LABORATORY RESULTS TO FIELD CONDITIONS

Several treatments tested under laboratory conditions were found to reduce the downward movement of broadcast seeds on the surface of a simulated road fill. The laboratory data, expressed in relative numbers of seeds retained, should not be interpreted literally as to what might happen on the surface of a road fill under field conditions. However, they are probably fair indices for judging the merits of each treatment.

Some general comments and recommendations follow:

1. Because of inherent physical characteristics, hard, rounded seed of cereal rye and yellow sweetclover are more apt to roll and slide downhill on road fills than the elongated, flat seed of intermediate wheatgrass and smooth brome grass.

2. Applying seed to a road fill pockmarked with shallow holes or to a wet road fill or applying wet seeds on a dry surface will enhance their retention after they fall. Treatment of holes on dry, crusted surfaces is superior to that on wet, soft road fills. The relative importance of these three treatments is more significant if hard, rounded seed are included in the mixture.

Added benefit to surface holes as seed traps comes from the natural covering of seed with slough material, thus protecting the seed from wind, promoting faster germination, and perhaps improving the chances for survival.

3. Seeding upon a paper mulch or after an unchopped hay mulch is applied proved to be the best methods tested for reducing the downhill movement of seed. However, substantial numbers of seeds will be trapped on the leaves and stems of the hay before they reach the soil surface. How many of these seeds will remain suspended in the mulch under the influence of wind, rain, and snow is problematical.

If the hay is chopped and mixed with asphalt binder, considerably more seeds are trapped and readily held by the tacky binder. Under these circumstances the standard procedure of applying wet seed with a Hydro-seeder machine prior to mulching with chopped hay-asphalt binder is more desirable. As the results of the study imply, the Hydro-seeder more effectively places seed in contact with the ground surface than the application of dry seed after this form of mulch is in place.





# Research Note

UNITED STATES DEPARTMENT OF AGRICULTURE  
FOREST SERVICE

**INTERMOUNTAIN FOREST & RANGE EXPERIMENT STATION**  
OGDEN UTAH

U.S. Forest Service  
Research Note INT-3

1963

## CULTURAL TREATMENTS STIMULATE GROWTH OF

### WESTERN WHITE PINE SEEDLINGS

Burton V. Barnes and R. T. Bingham<sup>1</sup>

#### ABSTRACT

An experiment was conducted to determine the effectiveness of cultural treatments (cultivating, fertilizing, and watering in all possible combinations) in stimulating growth rate and inducing strobilus formation in western white pine seedlings in northern Idaho. Although strobilus production was negligible, striking differences in total height and diameter at 12 inches above the ground were attributed to the cultural treatments. The combined three-factor treatment was most effective in stimulating height and diameter growth. Cultivation was the most effective single treatment and the most effective component of double treatments, particularly in stimulating diameter growth. The use of these cultural treatments is a promising method of developing seed orchard trees of sufficient size and vigor to bear large cone crops.

---

<sup>1</sup> Barnes and Bingham are research forester and plant pathologist, respectively, Intermountain Forest and Range Experiment Station, Moscow, Idaho.

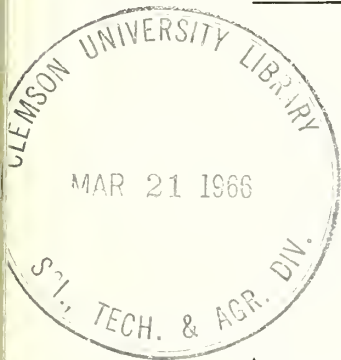

## INTRODUCTION

Foresters recognize that the growth of seedlings receiving some kind of cultural treatment typically would be greater than that of untreated seedlings. Only in gardens, arboreta, small private tracts, seed orchards, or seed production areas, however, can intensive care ordinarily be given to individual trees. Within a few years approximately 100 acres of western white pine seed orchards will be established to produce seed for planting stock resistant to the blister rust fungus, Cronartium ribicola Fischer. Thus, research was initiated to determine what kinds and levels of cultural treatments are most efficient in promoting growth and strobilus production. In seed orchards it is not only important that trees bear flowers at an early age, but that they attain a size and degree of branching complexity adequate for production of large quantities of cones.

## LITERATURE REVIEW

From the vast amount of experience and literature in agriculture, we know that cultural treatments (fertilizing, watering, and cultivating) generally improve growth and productivity of crop plants. Since we also assume this to be true with trees, the question becomes primarily one of kind and level of treatment which will maximize growth and stimulate strobilus production.

The effects of fertilizer upon forest tree seedlings have been investigated from many standpoints and no attempt is made to summarize this literature. Major contributions to fertilization literature were cited by Barnes and Bingham (1963). Forest fertilization has shown both positive and negative results in experiments with various tree species to stimulate growth and/or seed production (Leyton 1958; Austin and Strand 1960; Laurie 1960; Stoate et al. 1961; Swan 1961; Walters, Soos, and Haddock 1961), and generalizations about its effectiveness must always be qualified.

Irrigation and cultivation are also important cultural practices in agriculture and horticulture. They are known to stimulate vegetative growth and fruitfulness, but as yet little information is available of their effects on grafts or seedlings in tree seed orchards. Smith (1961) reported excellent growth of loblolly and slash pines which had been cultivated and fertilized. Though differences between fertilized and unfertilized trees were not significant, the rapid growth was attributed largely to annual machine and hand cultivation. Hughes and Jackson (1962) studied the effects of various fertilizer regimes upon growth of young slash pines in a plantation in south Georgia. Most fertilizer treatments failed to stimulate growth significantly in comparison to the controls. However, a comparison was made with an adjoining uncultivated plantation. Uncultivated trees took 4 years to reach a height of 61 inches which was attained by cultivated, unfertilized seedlings in 2 years. Aird (1962) found that growth of poplar cuttings was two to three times greater with cultivation than without.

Mosher (1960) studied irrigation and fertilization of 90-year-old ponderosa pine in northeastern Washington. After 2 years of irrigation and one season of



fertilization, radial growth of trees in irrigated plots was over 100 percent faster, while radial growth on fertilized but nonirrigated plots was only 29 percent faster than trees receiving no treatment.

MATERIALS AND METHODS

Four randomized blocks each with 10 planting spots (20-foot×20-foot spacing) were installed in 1955 on a cleared plot along Emerald Creek near Clarkia, Idaho, St. Joe National Forest, (NE $\frac{1}{4}$ NW $\frac{1}{4}$ , sec. 4, T. 42 N., R. 1 E., Latah County, Idaho). The elevation is approximately 2,800 feet. The original stand of young pole-size trees (western white pine, larch, and lodgepole pine) was cleared with a bulldozer in the fall of 1953. Debris was windrowed and the flash fuels burned in the fall of 1954. The site is level, moderately dry, and the soil is generally a deep sandy loam, relatively free of rock.

At each spot two 6-year-old seedlings were planted on either side of a stake marking the planting spot. Eight of the planting spots were used to test the following treatments:

- |                    |                                  |
|--------------------|----------------------------------|
| 1. Cultivating (C) | 5. Cultivating and Watering (CW) |
| 2. Fertilizing (F) | 6. Fertilizing and Watering (FW) |
| 3. Watering (W)    | 7. Cultivating, Fertilizing,     |
| 4. Cultivating and | and Watering (CFW)               |
| Fertilizing (CF)   | 8. No Treatment (NT)             |

Grafts of local intraspecific western white pine crosses on eastern × western white pine hybrid root stocks were planted at the two remaining spots in each block.

A 14.3:14.3:14.3 formula fertilizer was applied annually in the spring during the period 1956-1960 (table 1). Fertilizer was spread evenly in a circle around the base of each tree. Soil around each tree was cultivated at the time of fertilization and again at each watering in the summer. Trees were watered one to three times during the summer, depending on weather and soil moisture conditions. Each tree received about 24 gallons of water at each application.

Table 1.--Rate of application of a 14.3:14.3:14.3 fertilizer, 1956-1960,  
Emerald Creek Plot, St. Joe National Forest

Year	: Actual	: Radius	: Fertilizer per acre				
	: fertilizer	: of	: Elemental	: P <sub>2</sub> O <sub>5</sub>	: Elemental	: K <sub>2</sub> O	: Elemental
	: applied	: circle	: N	:	: P	:	: K
	<u>Pounds</u>	<u>Inches</u>	- - - - -	- - - - -	<u>Pounds</u>	- - - - -	- - - - -
1956-57	$\frac{1}{2}$	18	441	441	192	441	366
1958-59	1	18	882	882	385	882	732
1960	3	24	1,487	1,487	648	1,487	1,234

## RESULTS

Only 52 of the 80 trees planted were living in 1960. Nearly all mortality was attributable to pocket gophers, although heavy mortality at the fertilizer-only spots (five trees of eight died) probably was due indirectly to the treatment itself. Fertilizer greatly increased grass and weed competition around these trees.

Only two trees flowered during the 6-year treatment period. One tree receiving CFW treatment produced a single female strobilus in 1958 (tree age 9 years). This tree was later severed at the root collar by gophers and died in 1959. The other tree at the same planting spot produced two male strobili clusters in 1958, 14 male clusters in 1959, and three clusters in 1961.

Highly significant differences in total height and stem diameter at 12 inches above the ground were attributable to cultural treatments (figs. 1, 2, and 3). Duncan's multiple range test (Duncan 1955) was used to determine significant ( $P < 0.05$ ) differences between treatments (figs. 1 and 2).

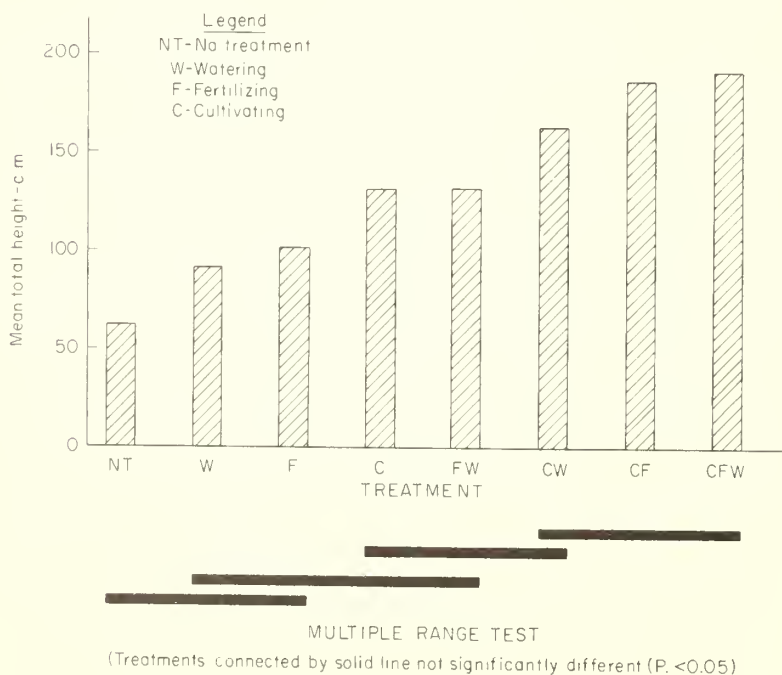

Figure 1. -- Effect of cultural treatment upon total height growth of western white pine seedlings.

Triple treatment (CFW) was most effective in stimulating height growth, but was not significantly different from two double treatments each including cultivation (CW, CF). Cultivation was the most effective single treatment. No significant differences were found in total height between untreated trees and trees receiving either water or fertilizer treatment alone.

Response to treatments was greater for diameter than for height (figs. 1 and 2). Again, CFW treatment was most effective and not significantly different from the CW treatment. Cultivation was the most potent single treatment. Each of the four more effective treatments included cultivation.

Because of the inconvenience and expense of irrigation, the frequency of applications was held to a minimum. With more liberal application, the effects of this treatment might have been greater.

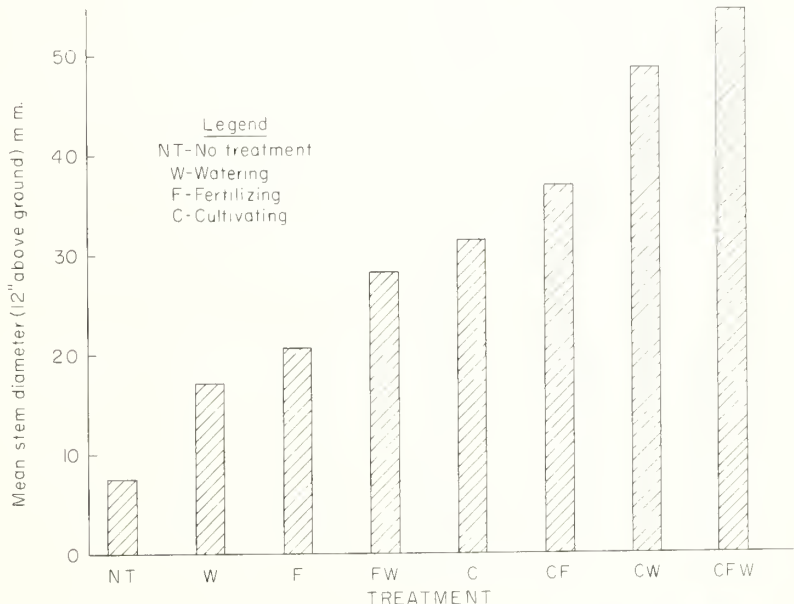

Figure 2. -- Effect of cultural treatment upon diameter growth of western white pine seedlings.

MULTIPLE RANGE TEST  
 (Treatments connected by solid line not significantly different ( $P < 0.05$ ))



Figure 3.--The trees in the background (average height, 6.8 feet) were cultivated and fertilized five consecutive growing seasons. The one in the foreground (average height, 1.8 feet) received no treatment.

## DISCUSSION

Previous experiments employing top grafting and fertilization, cultivation, and watering failed to markedly induce or stimulate flowering of western white pine trees (Barnes and Bingham 1963). Although flowering has not been induced by any cultural treatment employed in this experiment, the excellent vigor and form exhibited by trees receiving the CFW treatment is encouraging. In seed orchards, once flowering begins, the major emphasis probably will be upon the size and shape of the tree. Ultimately we anticipate greater success in stimulating strobilus production through use of cultural treatments rather than by strangulation, girdling, or other treatments which would injure the graft or seedling.

Experience with a breeding arboretum, composed of twice-transplanted seedlings of proven blister rust resistance, has given further encouragement in the use of cultural treatments. Of 764 6-year-old seedlings transplanted from field plots to the arboretum near Moscow, Idaho, in 1957, 16.4 percent had flowered (nearly all female) through the 1962 growing season (Bingham).<sup>2</sup> Most abundant flowering occurred in 1961 when seedlings were in their tenth growing season. We recognize, however, that although these trees received annual cultivation, watering, and fertilization, other environmental factors such as transplanting, soil, and climatic conditions, etc. may have been instrumental in hastening strobilus production.

---

<sup>2</sup> Bingham, R. T. (In preparation for publication). Precocious flowering in western white pine. Intermountain Forest & Range Experiment Station Research Note.

Wareing (1959) found that the attainment of a certain absolute size was a primary factor in determining the transition to the adult (physiologically mature) condition. If size is an important determinant of the adult condition in western white pine, appropriate cultural treatments should indirectly hasten flowering. In addition, the trees would have sufficient size and strength to bear relatively large cone crops.

Though fertilizing and watering were effective in this experiment, cultivation is apparently the simplest and most effective way of increasing the size of western white pine seedlings. Whether it is the most practical and effective single treatment in seed orchards having thousands of individuals remains to be seen.

#### LITERATURE CITED

Aird, Paul L.

1962. Fertilization, weed control and the growth of poplar. *Forest Sci.* 8: 413-428.

Austin, R. C., and R. F. Strand.

1960. The use of slowly soluble fertilizers in forest planting in the Pacific Northwest. *Jour. Forestry* 58: 619-627.

Barnes, Burton V., and R. T. Bingham.

1963. Flower induction and stimulation in western white pine. U.S. Forest Serv. Res. Paper INT-2, 10 pp. Intermountain Forest & Range Expt. Sta., Ogden, Utah.

Duncan, David B.

1955. Multiple range and multiple F tests. *Biometrics* 11: 1-42.

Hughes, Ralph H., and James E. Jackson.

1962. Fertilization of young slash pine in a cultivated plantation. U.S. Forest Serv. Southeastern Forest & Range Expt. Sta., Station Paper 148, 14 pp.

Laurie, M. V.

1960. The place of fertilizers in forestry. *The Empire Forestry Review* 39: 286-293.

Leyton, Leonard.

1958. Forest fertilizing in Britain. *Jour. Forestry* 56: 104-106.

Mosher, Milton M.

1960. Preliminary report of irrigation and fertilization of ponderosa pine. Washington Agr. Expt. Sta., Station Cir. 365, 5 pp.

Smith, Lloyd F.

1961. Rapid growth of slash and loblolly pines on cultivated plots. Tree Planters' Notes 46: 9-10.

Stoate, T. N., I. Mahood, and E. C. Crossin.

1961. Cone production in Douglas-fir (Pseudotsuga menziesii). Empire Forest Rev. 40: 105-110.

Swan, H. S. D.

1961. The mineral nutrition of Canadian pulpwood species. II. Fertilizer pellet field trials progress report No. 2. Pulp and Paper Res. Inst. of Canada, Res. Note 16, 6 pp.

Walters, J., J. Soos, and P. G. Haddock.

1961. The influence of fertilizers on the growth of Douglas-fir seedlings on the University of British Columbia Research Forest, Haney, B. C. Faculty of Forestry Univ. B. C. Res. Notes 31, 6 pp.

Wareing, P. F.

1959. Problems of juvenility and flowering in trees. Jour. Linnean Soc. London 56: 282-289.



# Research Note

UNITED STATES DEPARTMENT OF AGRICULTURE  
FOREST SERVICE

INTERMOUNTAIN FOREST & RANGE EXPERIMENT STATION  
OGDEN UTAH

U.S. Forest Service  
Research Note INT-4

1963

## WHY NOT USE BLUEPRINTS?

Karl E. Moessner<sup>1</sup>

Division of Forest Economics and Recreation Research

### ABSTRACT

Aerial photos and mosaics made from them are used as map substitutes on many field jobs. Blueprints from photographic negatives have been found to be equally useful and are far cheaper than the familiar photographic prints now in use.

Aerial photos and the photo maps or mosaics prepared from them have become working tools on many field jobs such as timber sales, road location, and firefighting. They make excellent map substitutes for orientation, annotations, and progress records. Although good quality contact prints are needed for office interpretation and direct measurement, they may not be required for fieldwork where the photo or mosaic is used merely as a map.

Research by numerous photographic supply firms has produced superior quality materials for reproducing mosaics and contact prints, both as negatives and as positives. But these top quality materials, though designed for stability and excellent detail, are not always necessary or even desirable. For example, they usually do not stand folding, some do not take pencil or ink, and they are often too expensive even when reproduced in quantity.

What the forester or other fieldman really needs is a reproduction comparable in cost and utility to the common blueline map he uses in such quantity, and he would prefer prints capable of being used stereoscopically.

Then, why not use blueprints?

Although blueprints produced from photographic negatives lack some definition found in the best photographic prints, they have been found to be quite satisfactory for many field uses.

They have distinct advantages:

---

<sup>1</sup> Research forester, Intermountain Forest and Range Experiment Station, Ogden, Utah.

- They are cheap. The cost is no more than for any blueline map.
- They can be used stereoscopically (fig. 1) with the overlapping contact photo print. This allows the interpreter to make pencil annotations on cheap and readily reproduced blueprint copy.
- Their definition is better than that of halftones, and stereovision has not been reduced because of a dot-screen process.
- Large mosaics reproduced as blueprints can be rolled, folded, cloth backed, and generally handled as any other map.



Figure 1.--This stereopair was copied from a blueprint (left) and a photographic print (right). The original stereopair was entirely suitable for use under stereo.

They have some limitations:

- They lack stability and surface found in the best photo materials, but are no worse than any commonly used blueline map.
- Reproduction must be at contact size; therefore, if enlargements are needed, a copy negative must be made first at the desired scale.

Even these limitations can be avoided. For example, where area measurements are to be made, a positive can be printed on continuous tone film and a dry print process such as ozalid used to produce identical paper prints.

In summary, for many field jobs blueprint reproductions are not only cheaper, but more usable than the familiar aerial photos and mosaics.





# Research Note

UNITED STATES DEPARTMENT OF AGRICULTURE  
FOREST SERVICE

**INTERMOUNTAIN FOREST & RANGE EXPERIMENT STATION**  
OGDEN UTAH

U.S. Forest Service  
Research Note INT-5

1963

## ACCURACY OF GROUND POINT LOCATION FROM AERIAL PHOTOGRAPHS

Karl E. Moessner, Research Forester  
Division of Forest Economics and Recreation Research

### ABSTRACT

The error of ground point location using aerial photos is commonly believed to be quite small. A recent study considering 84 points located with 1:16,000-scale aerial photos indicated the average error in ground location to be about 30 feet on lines averaging 500 feet in length. Errors averaged 17 feet in distance and 19 feet in direction, or slightly more than the width of a dull pencil line on the scale photos used.

Selected points were carefully located on the ground and marked on the aerial photos.



Aerial photos are commonly used in the ground location of previously selected points. The 2-power pocket stereoscope, photo-scale protractor, and the procedures described in "Aerial Photo Scale Protractors for Mountainous Areas" (Research Note 40) are used for this point location. Fieldwork also requires the use of staff compass and 100-foot steel tape.

Since base lines are selected near to and in the same datum as the point to be located, and since the lines run from these base lines to the selected points rarely exceed 1,000 feet in length, the error of location on the ground is commonly supposed to be quite small. However, this rather optimistic assumption is rarely checked; therefore, the question arises: How accurately can one actually locate points on the ground by using aerial photos?

### THE STUDY

This paper reports results from study of the 84 point locations made by 15 two-man field parties during a recent Forest Survey training school at Fraser Experimental Forest, Colorado.

Eighteen points in groups of three were pinpointed and circled on two 1:16,000-scale aerial photos. Although these points were located in an area generally considered to be rugged mountainous terrain, the test areas were near the valley floor and in no case did the slope of the lines to be run exceed 25 percent. These points were located on the ground by the most precise method available and a small, easily disguised stake was driven at each. The supervisors who located these points ran a line to a central point in each cluster and then short lines to the individual plot centers. These locations were then checked.

All men were given 16 hours of photo training, including three office problems. During this time they determined scale of photos, bearing, and distance from base lines to previously selected points in the manner to be used during the test. Each two-man crew was equipped with stereo pairs of photos with plot locations marked, pocket stereoscope, photo-scale protractor, needle point, pencil, tatum, staff compass, and 100-foot tape. Crews were briefed on which points to locate and told to lay out one base line on each pair of photos and to complete as many plots as possible in 8 hours.

One member of the permanent Forest Survey staff was assigned to each three-point group as referee. As each crew completed a line, the referee recorded length of line run and its direction, and the distance and bearing from the accepted location to the location made by the crew.

These records were plotted, checked for bias, and analyzed.

## RESULTS AND DISCUSSION

Averages obtained from these records are tabulated below:

Length of lines run from base lines	500±59 feet
Number of points located	5 per crew
Error in location	29.4±3.9 feet
Directional error	19.4±2.6 feet or 2° 13'
Distance error	16.8±2.8 feet
Proportion of lines to the right	54 percent
Proportion of lines too long	64 percent

These errors seem rather large for such short lines, yet the study indicates that such errors are probably normal for this technique.

Let us examine the procedure and tools used. To recover a ground location pinpointed on the aerial photo, the forester selects and pinpoints trees or other landmarks defining a base line that can be located both on the photos and on the ground. From this line he determines local photo scale and bearing. He also pinpoints a landmark on or near the line to be used as a reference or starting point. On his photos he measures the length of the base line, the distance from reference point to the point he is locating, and the bearing angle between this line and the base line, using a scale graduated to 25 feet and a protractor graduated in degrees. On the ground he measures the bearing and length of the base line, and then runs a compass line with the indicated bearing and distance from the reference point to the point to be located. To do this he used a standard steel tape and Forest Service staff compass graduated in one-half degrees.

This procedure, when used with 1:16,000-scale aerial photos, could hardly be expected to result in average errors much less than those obtained in this study.

What does a 17-foot average error in distance or a 19-foot average error in direction really mean on a 1:16,000-scale aerial photo? These distances measure about 0.012 to 0.015 inch or slightly more than the width of a line or dot made with a dull pencil on the photo.

Since these are total errors they include errors of measurement on photos as well as errors in fieldwork. Analysis of more than 200 photo measurements made under office conditions by foresters attending aerial photo training schools showed average errors of:

±41 minutes (about 6 feet in 500 feet) in direction  
±13.2 feet in 500 feet in distance.

This means that as much as one-third of the average error in direction and two-thirds of the average error in distance experienced in locating points on the ground can be due to the limitations of photo scales and techniques now in use.

These data strongly indicate that any significant improvement in the accuracy of point location must come through using larger scale photos rather than longer time in intensive field training.

To recover point 7 on the ground, the fieldman selects and pinpoints on his photo landmarks A and B defining the base line, and landmark RP as a starting point. He orients his photo-scale protractor over the intersection of the base line and compass line extended, by means of the bearing of base line AB (S. 32° W.) and reads bearing of compass line RP to 7 (N. 80° W.). Using the relationship of ground distance to photo distance determined by measurements of A-B he selects the correct scale and measures the distance RP to 7. His average error in recovering points on the ground can be expected to be about 30 feet.

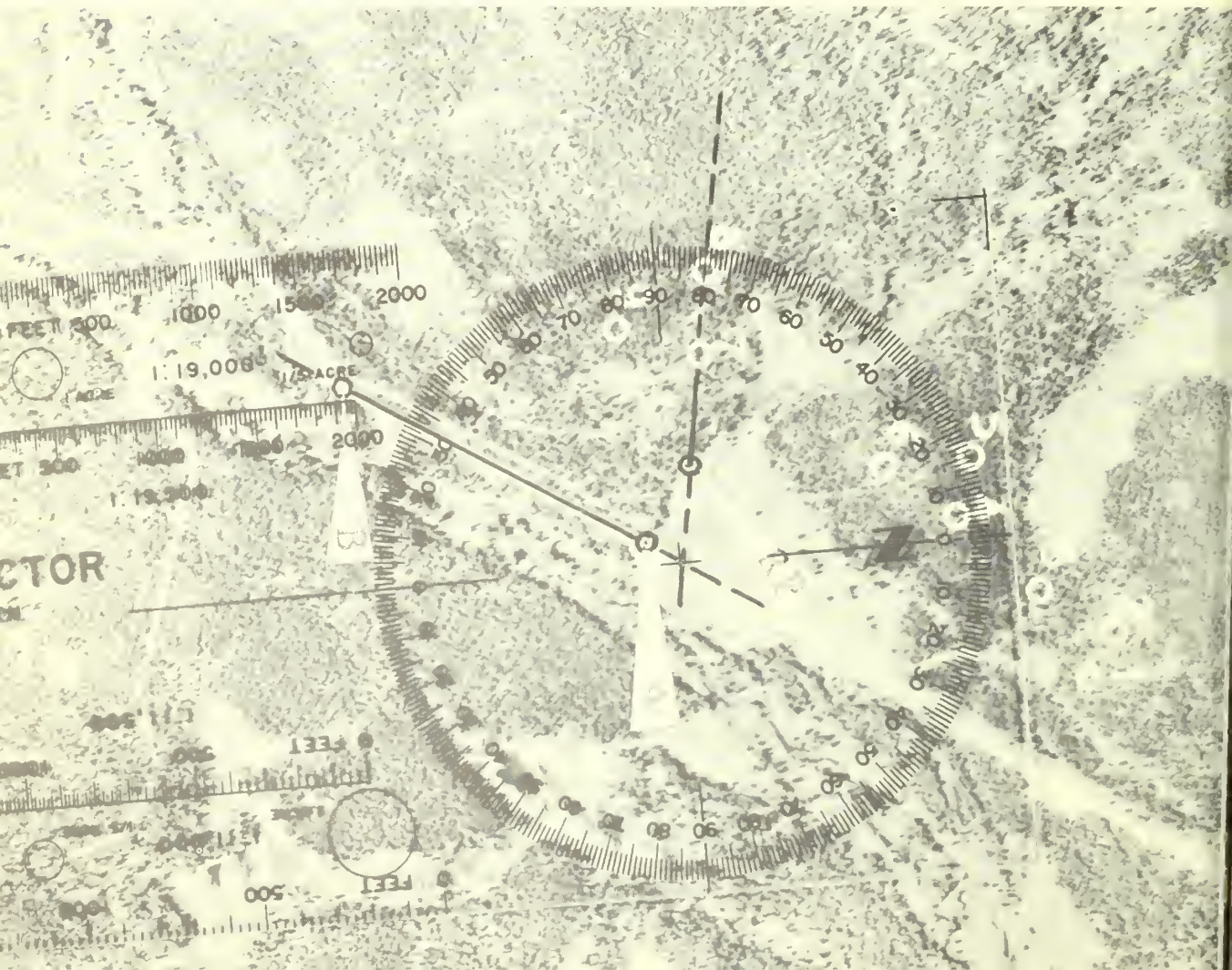



# Research Note

UNITED STATES DEPARTMENT OF AGRICULTURE  
FOREST SERVICE

INTERMOUNTAIN FOREST & RANGE EXPERIMENT STATION  
OGDEN UTAH

U.S. Forest Service  
Research Note INT-6

1963

## COMPOSITE AERIAL VOLUME TABLES FOR CONIFER STANDS IN THE MOUNTAIN STATES<sup>1</sup>

Karl E. Moessner, Research Forester  
Division of Forest Economics and Recreation Research

### ABSTRACT

This note presents new composite aerial volume tables for conifer stands based on data from 460 Forest Survey field plots. The two tables list average board-foot and cubic-foot volumes per acre by total height and crown cover class, and are usable for stratification by photo volume class. Regression formulae and measures of accuracy for the tables are shown.

### INTRODUCTION

The two composite tables published here were compiled for use in forest surveys performed by a combination of photo and ground sampling, as well as in volume estimates made from photo measurement alone. Aerial volume tables such as these are essential in making combined management-volume inventories where field sampling is based on stratification by photo volume class.<sup>2</sup>

### WHY COMPOSITE TABLES?

Few interpreters in the Mountain States can identify species with assurance on the conventional 1:15,000 or 1:20,000 scale panchromatic aerial photos. At least ten commercially important species are found commonly within these Mountain States, and in the northern part of the area at least six species may occur on a single acre. Forest Survey now classifies mixed stands into timber types named for the species having a plurality of the number of dominant trees.<sup>3</sup> In many mixed stands the predominant species cannot be determined by photo interpretation. Some idea of the difficulty of this problem of interpretation may be gathered from the following tabulation of timber types on 460 Forest Survey field plots. Measurements from these plots provided the raw data for the two tables published here. For the tabulation below, plots having 80 percent or more of their volume in the key species were considered pure.

Key species	Percent of plots classified as pure	Key species	Percent of plots classified as pure	Key species	Percent of plots classified as pure
Douglas-fir	66	Whitebark and		Western hemlock	33
Ponderosa pine	88	limber pine	33	Western redcedar	45
Western white pine	14	Grand fir	12	Western larch	42
Lodgepole pine	67	Spruce--alpine fir	35	All plots	58

<sup>1</sup> Including Montana, Idaho, eastern Oregon and Washington, South Dakota, Wyoming, Colorado, Utah, Nevada, Arizona, and New Mexico.

<sup>2</sup> Moessner, Karl E. A test of aerial photo classifications in forest management-volume inventories. U.S. Forest Serv. Intermountain Forest and Range Expt. Sta. Res. Paper INT-3, 16 pp. 1963.

<sup>3</sup> Until recently this was a plurality of merchantable volume.

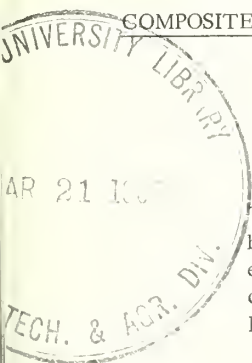

COMPOSITE AERIAL VOLUME TABLE FOR CONIFER STANDS IN THE MOUNTAIN STATES

Gross cubic-volume<sup>1</sup> per acre by average stand height and crown cover

Stand height <sup>2</sup> (feet)	Crown cover <sup>3</sup> (percent)									
	5	15	25	35	45	55	65	75	85	95
	<u>Ten cubic feet</u>									
30	--	8	25	38	48	55	59	60	57	52
35	4	24	42	56	67	74	79	81	79	74
40	20	41	60	75	87	96	102	104	103	100
45	36	59	79	96	109	120	127	130	131	128
50	53	78	100	118	133	145	154	159	161	160
55	70	97	121	142	159	173	183	191	195	195
60	88	118	144	167	186	202	215	225	231	234
65	107	139	168	193	215	234	249	261	270	275
70	126	161	193	221	246	268	286	301	312	320
75	146	184	219	251	279	303	325	342	357	368
80	166	208	246	281	313	341	366	387	405	419
85	187	232	275	314	349	381	409	434	455	473
90	208	258	304	347	387	423	455	484	509	531
95	230	284	335	382	426	466	503	536	566	592
100	252	311	367	419	467	512	554	591	625	656
105	275	339	400	457	510	560	606	649	688	723
110	299	368	434	496	555	610	661	709	753	794
115	323	398	469	537	602	662	719	772	822	867
120	347	428	506	580	650	716	779	838	893	944
125	372	460	543	623	700	772	841	906	967	1024
130	398	492	582	669	751	830	905	976	1044	1108
135	424	525	622	715	805	890	972	1050	1124	1194
140	451	559	663	763	860	952	1041	1126	1207	1284
145	478	594	705	813	916	1016	1112	1205	1293	1377
150	506	629	748	864	975	1083	1186	1286	1382	1473
155	535	666	793	916	1035	1151	1262	1370	1473	1573
160	563	703	838	970	1097	1221	1341	1456	1568	1676
165	593	741	885	1025	1161	1293	1421	1545	1665	1781
170	623	780	933	1082	1227	1367	1504	1637	1766	1890

<sup>1</sup> Gross volume, in all trees 5.0 inches d.b.h. and larger, from stump to 4.0-inch top. Volume from Forest Survey-total height-d.b.h. tables.

<sup>2</sup> Average height of dominant stand, photo measurement field checked.

<sup>3</sup> Crown cover of dominant stand, photo measurement.

Based on 460 1/5-acre plots taken in Montana, Idaho, South Dakota, Wyoming, Colorado, Arizona, and Utah.

Volume Equation

$$V_C = 0.2444H + 0.0007969H^2 + 0.2329C - 0.001468C^2 - 0.001986HC + 0.00005933H^2C - 0.000003223HC^2 - 10.2863.$$

Where  $V_C$  = Volume per acre in 10 cubic feet; H = stand height in feet; and C = crown closure in percent.

Multiple correlation coefficient (R) = 0.860. Aggregate deviation: Table 0.12 percent high.

Standard error of estimate = ± 1370 cubic feet per acre, or 49.5 percent of the mean plot volume.

Forest Survey, Intermountain Forest and Range Experiment Station, Ogden, Utah, 1963.

COMPOSITE AERIAL VOLUME TABLE FOR CONIFER STANDS IN THE MOUNTAIN STATES

Gross sawtimber volume<sup>1</sup> by average stand height and crown cover

Stand height <sup>2</sup> (feet)	Crown cover <sup>3</sup> (percent)									
	5	15	25	35	45	55	65	75	85	95
	Hundred board feet									
40	5	8	9	10	11	11	10	8	6	3
45	13	17	20	22	23	23	22	20	17	12
50	22	28	32	35	37	37	36	33	30	24
55	31	38	44	49	52	53	52	49	45	39
60	40	50	58	64	68	70	70	68	63	57
65	49	62	72	81	86	89	90	88	84	78
70	59	75	88	98	105	110	112	111	107	101
75	70	88	104	117	126	133	136	136	133	127
80	80	102	121	137	149	157	162	164	162	156
85	91	117	139	158	172	183	190	193	193	188
90	102	133	158	180	198	211	220	225	226	223
95	114	149	178	204	224	241	252	259	262	260
100	126	165	199	228	253	272	286	296	301	301
105	139	183	221	254	282	305	323	335	342	344
110	152	200	244	281	313	340	361	376	386	390
115	165	219	267	310	346	376	401	419	432	439
120	179	238	292	339	380	415	443	465	481	490
125	193	258	317	370	415	455	487	513	532	545
130	207	279	344	401	452	496	533	563	586	602
135	222	300	371	434	491	540	581	616	643	662
140	237	322	399	469	531	585	632	670	702	725
145	252	344	428	504	572	632	684	728	763	791
150	268	367	458	540	615	680	738	787	828	860
155	284	391	489	578	659	731	794	849	894	931
160	300	415	521	617	705	783	852	912	964	1006
165	317	440	553	657	752	837	912	979	1035	1083
170	334	466	587	699	800	892	975	1047	1110	1163

<sup>1</sup>Gross volume, International 1/4-inch trees 11.0 inches and larger to a variable 5.5-inch minimum top diameter. Volume from Forest Survey-total height-d.b.h. tables.

<sup>2</sup>Average height of dominant stand, photo measurement field checked.

<sup>3</sup>Crown cover of dominant stand, photo measurement.

Based on 460 1/5-acre plots taken in Montana, Idaho, South Dakota, Wyoming, Colorado, Arizona, and Utah.

Volume Equation

$$V_B = 1.0455H + 0.004599H^2 - 0.2100C + 0.01068C^2 - 0.008925HC + 0.0005473H^2C - 0.0003504HC^2 - 45.38.$$

Where  $V_B$  = Volume in hundred board feet per acre; H = stand height in feet; and C = crown closure percent.

Multiple correlation coefficient (R) = 0.859. Aggregate deviation: Table 1.35 percent high.

Standard error of estimate = ±7747 board feet per acre, or 60.69 percent of the mean plot volume.

Forest Survey, Intermountain Forest and Range Experiment Station, Ogden, Utah, 1963.

Even if we could have located enough pure plots so that we could prepare an individual table for each species in this array, the mixture of species found on many sample locations would prevent effective application of the tables over much of the area.

The use of composite tables together with adjustment factors for differences in species and location has been well established in ground cruising. Composite aerial volume tables also have been published by several Forest Experiment Stations.<sup>4</sup> Adjustment factors computed from a subsample of the photo plots measured on the ground have been used to obtain a very satisfactory estimate of net scaled volume.<sup>5</sup> Such a procedure can also be used to calculate proration factors when volume is required by species or other breakdown.

### CONSTRUCTION OF TABLES

The two composite aerial photo volume tables published here were prepared from data compiled from 460 Forest Survey field plots measured in Montana, Idaho, South Dakota, Wyoming, Colorado, Arizona, and Utah. The tables relate gross board-foot and cubic-foot volumes from field measurements on 1/5-acre plots to photo measurements of:

1. Average total height of the dominant stand. This measurement, though made on photos, was checked by comparing it with the average height obtained from ground measurement of dominant and codominant trees. Sample plots with height differences which exceeded the expected error and could not be reconciled were not used in the table.

2. Crown coverage of the dominant stand. This measurement was made on photos only since readings of comparable accuracy could not be obtained on the ground.

Average crown diameter of the dominant stand was also measured on photos and tested as a variable, but it was not included in the final tables.

Gross volumes,<sup>6</sup> computed from field data using Forest Survey total height d.b.h. tables, were:

1. Gross cubic-foot volume in all trees 5.0 inches d.b.h. and larger to a 4.0-inch top diameter.
2. Gross board-foot volume (International  $\frac{1}{4}$ -inch rule) in all trees 11.0 inches and larger to a variable top diameter not less than 5.5 inches.

The tables were constructed by machine compilation using a multiple regression analysis. The basic independent variables tested included three stand characteristics commonly measured on aerial photos: average total height (H), average crown diameter (D), and crown cover (C). Stepwise regression of some 45 possible combinations of these basic variables and their cross products indicated that each photo variable was significant, but crown diameter was of only minor importance. This analysis also indicated that each degree up to the fifth added to the efficiency of the equation. However, because of inadequate distribution of the basic data, the higher power equations appeared to produce unrealistic curves. For this reason the tables published here were prepared from equations that included only total height and crown cover and their squares and cross products.

The volume equation and the standard measures of accuracy accompany each table. The standard error of estimate shown for each table is based on data from the 1/5-acre plots used in preparing the tables. However, these tables present estimates of volume per acre; therefore, when field data are obtained by means of the Forest Survey 10-point location or any other method that provides a good estimate of the acre, these standard errors should be substantially reduced.

### TESTS OF THE TABLES

These tables now are being tested empirically against others that were prepared from the same data but that include crown diameter as a variable. Comparisons also are being made between these tables and those prepared previously for individual species to determine whether species adjustment factors are required. These empirical tests should indicate whether a single composite aerial table can be used for all conifer species and locations in the Mountain States.

<sup>4</sup>Including the Central States, Intermountain, Southern, Lake States, and Northeastern Stations.

<sup>5</sup>Moessner, Karl E. Estimating timber volume by direct photogrammetric methods. Soc. of American Foresters Proc., 1959. Pp. 148-151.

<sup>6</sup>These included both cull trees and cull portions of sound trees since neither can be recognized on photos.





# Research Note

UNITED STATES DEPARTMENT OF AGRICULTURE  
FOREST SERVICE

**INTERMOUNTAIN FOREST & RANGE EXPERIMENT STATION**  
OGDEN UTAH

U.S. Forest Service  
Research Note INT-7

1963

## MONTANA CHRISTMAS TREE EXPORTS DECLINE FOR THIRD STRAIGHT YEAR

Thomas O. Farrenkopf  
Division of Forest Economics and Recreation Research

### ABSTRACT

Authoritative data on shipments by rail and truck of Montana Christmas trees show a consistent decline for the past 3 years. This is largely the result of severe attacks by disease and insects, which damaged the appearance of harvestable trees. Shipments in 1962 are compared with those for 1961. Rail and truck shipments for the past 20 years are summarized.

Christmas tree shipments from Montana<sup>1</sup> have fluctuated widely since 1942, the year of the first survey, from varied causes--weather, markets, transportation, and damage by insects and diseases. Shipments generally increased from 1942 until 1956 but declined in 1957, when insect attacks severely damaged the appearance of harvestable trees. In 1958 this damage was compounded when epidemic diseases spread through part of the range of Douglas-fir, the principal Christmas tree species. As a result of all these factors, Christmas tree shipments in 1962 fell to the lowest number in 19 years.

The 2.2 million trees shipped in 1962 represent a 6-percent decrease from 1961 shipments<sup>2</sup> and a 46-percent decrease from 1956,<sup>3</sup> the peak year. Comments gathered

<sup>1</sup> This report deals only with shipments of trees to markets outside Montana rather than total Christmas tree production for the State. Each of the transstate railway lines supplied data for trees shipped by rail; the State Forester, the University of Montana, and the National Forests supplied figures on truck shipments.

<sup>2</sup> Wilson, Alvin K. Severe decline in Montana Christmas tree shipments. Intermountain Forest and Range Experiment Station Research Note 98, 4 pp. 1962.

<sup>3</sup> Wilson, Alvin K. A new high in Montana Christmas tree shipments. Intermountain Forest and Range Experiment Station Research Note 44, 4 pp. 1957.

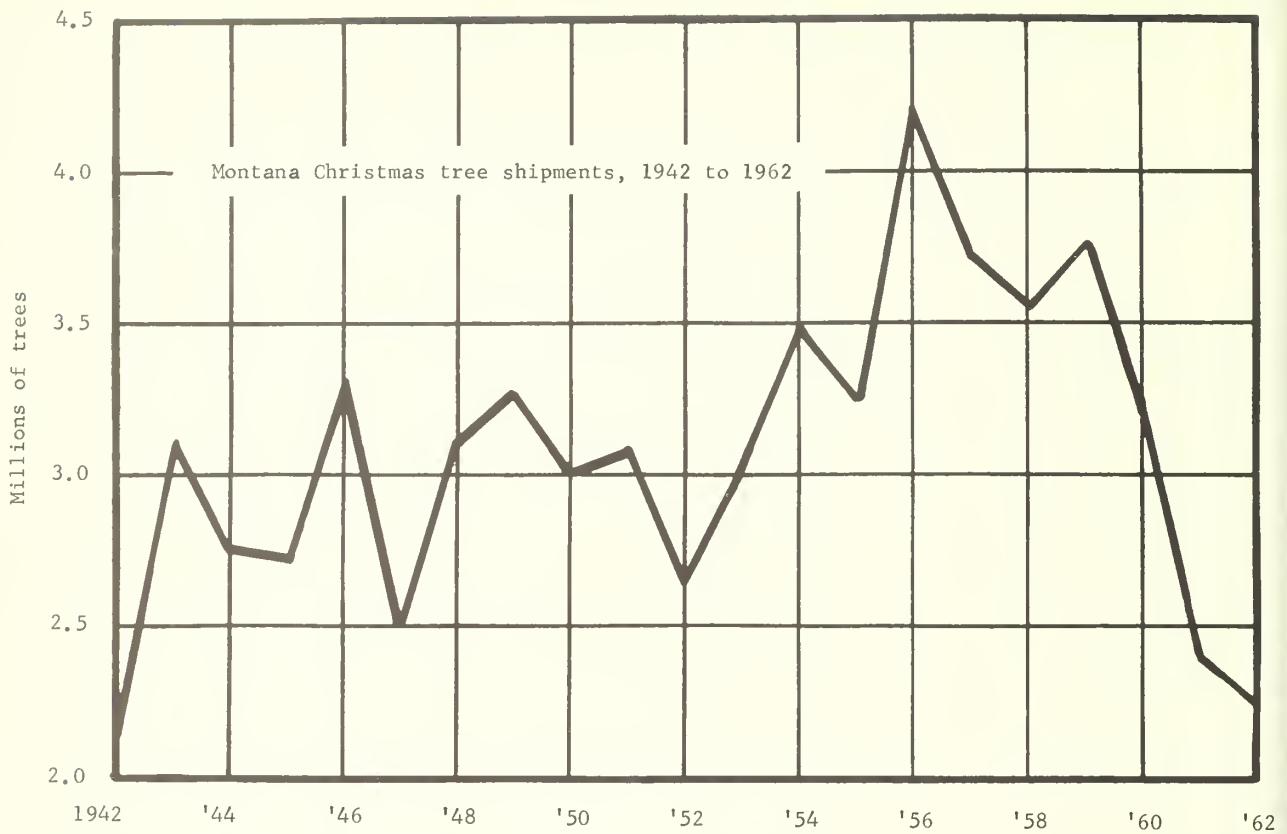

from several official sources in Montana indicate that demand for Christmas trees in 1962 exceeded the supply. Damage by insects and disease in Lincoln County alone, as reported by the Kootenai National Forest, kept an estimated 70,000 trees from being harvested in 1962. Reports from other National Forests indicate that similar losses occurred in all Christmas tree producing areas of western Montana.<sup>4</sup>

Most of the losses reported by the National Forests were due to insect damage. As in previous years, Douglas-fir needle midge, spruce budworm, and in some instances the Cooley spruce gall aphid, were responsible for reduction in quality of Douglas-fir. Douglas-fir needle midge, present throughout the range of Douglas-fir, is epidemic in the principal harvest areas (in and around the Kootenai National Forest) and causes the major losses to the industry. Spruce budworm is a destructive factor in the Lolo and Bitterroot National Forests and the Garnet Range, east of Missoula, where Christmas tree harvest has been less than in the northern counties. It appears to be spreading northward. This insect has practically eliminated the small commercial Christmas tree operations east of the Continental Divide. For the second consecutive year the School of Forestry at Montana State University was unable to harvest trees from University lands near Missoula because of spruce budworm infestation, which was more severe this year than in 1961. Forest entomologists see no immediate indication of decline in populations of these insects.

<sup>4</sup> West of the Continental Divide.

Table 1.--Shipments of Christmas trees by rail and truck from Montana, by counties, 1962

County	Thousands of trees		Total	Percent
	Rail shipments	Truck shipments		
Lincoln	727	195	922	41
Flathead	622	272	894	40
Lake	90	76	166	8
Sanders	100	21	121	5
Missoula	57	61	118	5
Others	0	28	28	1
Total	1,596	653	2,249	100

Table 2.--Rail and truck Christmas tree shipments from Montana, 1942-1962

Year	Rail shipments		Truck shipments		Total shipments
	Thousands of trees	Percent	Thousands of trees	Percent	
1942	2,139	97	65	3	2,204
1943	2,931	94	172	6	3,103
1944	2,636	96	120	4	2,756
1945	2,556	94	168	6	2,724
1946	2,867	87	432	13	3,299
1947	2,210	88	306	12	2,516
1948	2,731	87	392	13	3,123
1949	2,817	86	440	14	3,257
1950	2,693	89	325	11	3,018
1951	2,784	90	301	10	3,085
1952	2,375	90	270	10	2,645
1953	2,389	79	631	21	3,020
1954	2,760	79	723	21	3,483
1955	2,855	88	380	12	3,235
1956	3,349	80	847	20	4,196
1957	2,631	71	1,089	29	3,720
1958	2,470	69	1,098	31	3,568
1959	2,741	73	1,010	27	3,751
1960	2,237	70	963	30	3,200
1961	1,662	69	730	31	2,392
1962	1,596	71	653	29	2,249

The disease attacks on Christmas tree stock have diminished. Although losses due to Rhabdocline and Rhabdogloeum needlecasts ("Christmas tree blight") were reported, these chronic diseases have been declining for the past 3 years. Since needle dropoff occurs within 2 years after infection, much of the reported damage to the current harvest has resulted from past infestation. Research studies are attempting to discover antibiotics to control these diseases.

Production in the two principal counties, Lincoln and Flathead, increased over 1961 (5 percent and 10 percent, respectively), despite the heavy insect damage. However, these increases were more than offset by a marked decline in all other counties --especially in Missoula County, which produced only 48 percent of its 1961 production.

Table 3.--Rail shipments of Montana Christmas trees to leading markets, 1962 and 1961

State	1962		:	State	1961	
	Thousands of trees	Percent			Thousands of trees	Percent
Texas	361	23	:	Texas	394	24
Oklahoma	218	14	:	California	238	14
California	166	10	:	Oklahoma	218	13
Iowa	157	10	:	Iowa	166	10
Missouri	157	10	:	Kansas	152	9
Kansas	138	9	:	Missouri	147	9
Nebraska	76	5	:	Nebraska	81	5
Oregon	52	3	:	Illinois	71	4
Illinois	48	3	:	Louisiana	33	2
Others <sup>1</sup>	223	13	:	Others	162	10
Total	1,596	100		Total	1,662	100

<sup>1</sup>Includes 5,000 trees exported to Mexico.

Rail shipments in 1962 were the lowest of the 20-year period of record. These shipments were about 4 percent (66,000 trees) less than in 1961. Truck shipments declined 10.5 percent (77,000 trees) below 1961 figures.

In addition to rail shipments to 24 States in 1962, one carload of trees was exported to Mexico. The leading market States--Texas, Oklahoma, California, Iowa, and Missouri--accounted for 67 percent of all rail shipments.



# Research Note

UNITED STATES DEPARTMENT OF AGRICULTURE  
FOREST SERVICE

INTERMOUNTAIN FOREST & RANGE EXPERIMENT STATION  
OGDEN UTAH

U.S. Forest Service  
Research Note INT-8

1963

## INSECT DAMAGE IN GRAND FIR CONES

Robert D. Pfister and Phil C. Woolwine<sup>1</sup>  
Division of Forest Management and Disease Research



### ABSTRACT

In this 1961 northern Idaho study, depredation by six genera of cone and seed insects on grand fir caused loss estimated at more than 15 percent of the seed crop. Dissection verified exterior signs of attack in nearly all cones examined after mid-August.

### INTRODUCTION

Cone and seed insects are recognized as important agents of seed destruction in grand fir (*Abies grandis* (Dougl.) Lindl.). Observations of insect losses were made in 1961, a good seed year for grand fir, in a northern Idaho area in conjunction with a study of techniques for ripening cones artificially.

### METHODS

Grand fir cones for this study were collected on the Coeur d'Alene National Forest in a 100- to 200-year-old mixed conifer stand on a northerly slope at about 3,200 feet elevation. Two or three trees were felled and cones collected on each of five dates separated by 10-day intervals. Those cones with external evidence of

<sup>1</sup> Research forester, and research assistant (during the summer of 1961), respectively. Authors headquartered at Intermountain Station's Forestry Sciences Laboratory, Moscow, Idaho, maintained in cooperation with the University of Idaho.

insect infestation, such as entrance holes, frass, discoloration, and deformation, were segregated and 10 to 20 from each date were dissected to determine (1) the kinds and numbers of insect larvae, (2) the amount of seed destroyed, and (3) the dependability of exterior signs of infestation.

These larvae were tentatively identified by comparing their appearance with characteristics described by Keen:<sup>2</sup>

Fir seed maggots	-	<u>Earomyia</u> spp.
White-fir cone moth	-	<u>Barbara</u> sp. (true fir form)
Fir coneworm	-	<u>Dioryctria abietella</u>
Fir seed moth	-	<u>Laspeyresia bracteata</u>
Fir-seed gall midges	-	<u>Dasyneura abiesemia</u>
Seed chalcids	-	<u>Megastigmus</u> spp.

Specimens were preserved for verification, but inadequacy of keys for immature stages prevented definite identification of all but Dioryctria abietella. Because attempts to rear adult specimens were unsuccessful, there is some question about the true identities of species reported.

## RESULTS

Of the 1,633 cones examined, about one-fourth had exterior indications of insect attack (table 1). This ratio did not vary greatly with the date of collection. Although dissection failed to verify suspected infestation in about half of the suspected cones from the two earliest collections, insects were found in nearly all the dissected samples from later dates.

Table 1. Apparent and actual cone infestation on five collection dates

Collection date	Trees sampled	Total cones	Apparent infestation <sup>1</sup>	Actual infestation <sup>2</sup>
			Percent	Percent
7/25	3	291	37	26
8/ 4	2	433	25	10
8/15	3	284	22	20
8/24	2	393	26	26
9/ 3	2	232	24	24

<sup>1</sup> Based on exterior indications of insect attack.

<sup>2</sup> Based on results of dissection.

<sup>2</sup> Keen, F. P. Cone and seed insects of western forest trees. U.S. Dept. Agr. Tech. Bull. 1169, 168 pp., illus. 1958.

Five genera of insects caused significant cone damage. Maggots, present in about 7 percent of the cones, caused the most conspicuous damage. Maggot infestation ultimately destroys the entire cone; most of these cones had disintegrated by the August 24th collection.

An average of 14 percent of all cones were infested by cone moths or cone-worms. This combined infestation caused an estimated 5-percent seed loss.

Because midges were very difficult to detect, their presence went largely unnoticed in the early stages. But, by the last collection date they were detected in 24 percent of the cones, causing an estimated seed loss of at least 3 percent.

### DISCUSSION

Midge and chalcid infestations are not revealed by outward appearance of cones. Estimates of damage by midges are therefore undoubtedly low. No estimate of chalcid damage was made because only one chalcid was discovered during cone dissection. Many seeds would have to be dissected to reliably estimate the total loss caused by these species.

It appears probable that total losses of grand fir seed to insects in 1961 exceeded 15 percent in the observed area. While of limited scope, this study points out the need to learn more about the influence of environmental conditions, including size of cone crops, on infestations by cone and seed insects, and to determine the possibilities for control.







# Research Note

UNITED STATES DEPARTMENT OF AGRICULTURE  
FOREST SERVICE

INTERMOUNTAIN FOREST & RANGE EXPERIMENT STATION  
OGDEN UTAH

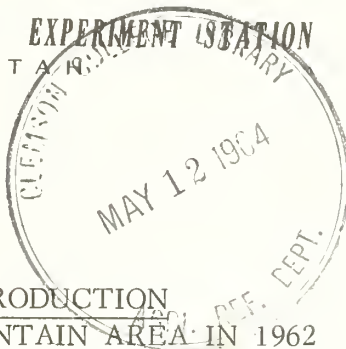

U.S. Forest Service  
Research Note INT-9

1963

## COMMERCIAL POLE PRODUCTION IN THE NORTHERN ROCKY MOUNTAIN AREA IN 1962

Alvin K. Wilson, Research Forester  
Division of Forest Economics and Recreation Research

### ABSTRACT

The latest survey of commercial pole production in Idaho, Montana, and northeastern Washington showed that nearly 310,000 poles were produced in 1962. This figure is 29 percent below the output for 1960 (the latest year for which comparable data are available). Production declined considerably between 1947 and 1962; most of this decline occurred prior to 1955.

Commercial pole production in Idaho, Montana, and northeastern Washington totaled 309,889 poles in 1962, according to results of the latest survey.<sup>1</sup> Compared to production in 1960--the most recent year for which fully comparable data are available--this reflects a decline of 29 percent (127,273 poles). Production for 1962 was estimated to have been 16 percent (60,535 poles) below the output of 1961.<sup>2</sup>

<sup>1</sup> Sponsored in northern Idaho (north of the Salmon River), Montana, and northeastern Washington by the Rocky Mountain Pole and Treating Association, Spokane, Washington. The Association contacted all pole companies known to operate in this area. The Intermountain Forest and Range Experiment Station made additional contacts to obtain reports for operations in southern Idaho and compiled data from the reports furnished by all companies that participated in the survey.

<sup>2</sup> Several companies did not furnish reports in the survey for 1961 production but reported in the surveys of 1960 and 1962 production. To obtain estimates for 1961, interpolations were made between the 1960 and 1962 quantities reported by these companies and are included in the statistics shown here. Data for both 1960 and 1962 are based on reports from all known pole companies that operated within the northern Rocky Mountain area or received poles from this area.

Table 1.--Poles produced in Montana, Idaho, and northeastern Washington,  
by species, 1962

Species	Montana	Idaho	Northeastern: Washington	Total	Percent of total
-----Number-----					
Western redcedar	4,962	131,068	23,852	159,882	52
Lodgepole pine	105,328	9,245	0	114,573	37
Western larch	11,795	9,286	14,209	35,290	11
Douglas-fir	144	0	0	144	( <sup>1</sup> )
Total	122,229	149,599	38,061	309,889	
Percent	40	48	12		100

<sup>1</sup> Less than 0.5 percent.

Table 2.--Pole production in Montana, Idaho,<sup>1</sup> and northeastern Washington,  
by species, 1947-1962

Year	Species					Total
	Western redcedar	Lodgepole pine	Western larch	Douglas- fir	Other <sup>2</sup>	
-----Number-----						
1947	230,872	351,310	221,990	6,473	6,557	817,202
1948	212,785	138,099	90,879	5,419	804	447,986
1949	286,116	186,262	121,214	5,720	0	599,312
1950	217,049	92,338	71,651	9,070	0	390,108
1951	192,271	136,628	126,332	10,116	0	465,347
1952	217,721	110,621	152,761	19,049	0	500,152
1953	191,551	128,523	90,245	3,516	0	413,835
1954	138,624	101,842	36,938	768	0	278,172
1955	131,860	95,027	61,688	5,941	0	294,516
1956	193,393	246,947	111,268	36,334	0	587,942
1957	280,764	142,361	82,209	13,559	0	518,893
1958	127,039	173,331	37,152	2,709	0	340,231
1959	140,410	244,015	42,796	1,360	0	428,581
1960	204,894	177,200	50,727	4,341	0	437,162
1961 <sup>3</sup>	188,922	135,983	41,567	3,952	0	370,424
1962	159,882	114,573	35,290	144	0	309,889
Average, last 5 years	164,229	169,021	41,506	2,501	0	377,257

<sup>1</sup> Data for 1952, and 1956 through 1962, are for the entire State; data for other years are for northern Idaho only. For the years of record, southern Idaho's annual output (all from lodgepole pine) did not exceed 6.2 percent of the State's total in any year; output ranged from 6,000 poles (1952) to a high of 10,292 poles (1956).

<sup>2</sup> Mainly ponderosa pine.

<sup>3</sup> Based in part on interpolations from 1960 and 1962 reports. See text footnote 2, page 1.

Table 3. -- Pole production in Montana, Idaho, and northeastern Washington, and imported poles, 1947-1962

Year	Poles grown and cut in			Poles imported : from Canada and : the west coast
	Montana	Idaho <sup>1</sup>	Northeastern : Washington	
	Number			
1947	324,734	316,764	175,704	356,643
1948	166,856	205,035	76,095	227,069
1949	221,815	300,808	76,689	311,291
1950	148,473	180,410	61,225	226,159
1951	216,188	193,341	55,818	132,966
1952	181,985	229,777	88,390	379,686
1953	177,130	206,915	29,790	262,017
1954	137,531	131,110	9,531	229,119
1955	138,260	131,281	24,975	77,071
1956	303,635	211,451	72,856	125,569
1957	177,979	252,941	87,973	181,584
1958	181,627	132,054	26,550	126,971
1959	255,264	135,400	37,917	99,821
1960	190,487	188,719	57,956	96,980
1961 <sup>2</sup>	147,205	177,638	45,581	58,018
1962	122,229	149,599	38,061	12,592
Average, last 5 years	179,362	156,682	41,213	78,876

<sup>1</sup>Data for 1952, and 1956 through 1962, are for the entire State; data for other years are for northern Idaho only. For the years of record, southern Idaho's annual output (all from lodgepole pine) did not exceed 6.2 percent of the State's total in any year; output ranged from 6,000 poles (1952) to a high of 10,292 poles (1956).

<sup>2</sup>Based in part on interpolations from 1960 and 1962 reports. See text footnote 2, page 1.

These marked declines occurred in all the principal pole species; western red-cedar output for 1962 was down 22 percent from 1960, lodgepole pine was down 35 percent, and western larch was down 30 percent.

Severe declines likewise occurred in each of the northern Rocky Mountain pole-producing areas. Montana's production (principally from lodgepole pine) declined 36 percent from 1960; Idaho's output was down 21 percent, and northeastern Washington's production was 34 percent below 1960. In the same period, imports of poles from Canada and the west coast to yards in the area fell off 87 percent.

Table 4.--Distribution of 1962 pole production in Montana, Idaho, and northeastern Washington, by species, length, and American Standards Association classes

Pole length (feet)	A. S. A. Class										All
	1	2	3	4	5	6	7	8	9	10	
----- Percent of total -----											
<u>WESTERN REDCEDAR</u>											
25	0.5	0.3	0.4	0.8	1.7	2.6	1.6	0.3	0.6	<sup>1</sup> --	8.8
30	.3	.3	.6	1.3	3.1	3.5	2.2	.2	.1	--	11.6
35	.5	.5	1.7	4.6	9.9	5.8	2.2	--	<sup>2</sup> 0	0	25.2
40	.6	1.1	3.6	6.3	6.0	2.5	.1	0	0	0	20.2
45	.7	1.4	4.0	4.0	2.2	--	0	0	0	0	12.3
50	.7	1.6	2.8	1.8	.2	0	0	0	0	0	7.1
55	3.2	4.8	5.1	1.7	--	0	0	0	0	0	14.8
All	6.5	10.0	18.2	20.5	23.1	14.4	6.1	.5	.7	--	100.0
<u>LODGEPOLE PINE</u>											
25	--	--	.1	.2	.9	2.1	5.4	1.0	26.6	7.7	44.0
30	--	--	.1	.5	1.7	3.8	4.2	1.1	4.4	--	15.8
35	--	.1	2.7	3.1	6.0	7.5	2.9	--	--	0	22.3
40	--	.1	3.8	2.8	4.0	2.1	0	0	0	0	12.8
45	--	.1	1.0	2.7	.8	--	--	0	0	0	4.6
50	--	.1	.2	.1	--	--	0	0	0	0	.4
55	--	--	--	--	0	0	0	0	0	0	.1
All	.1	.4	7.9	9.4	13.4	15.5	12.5	2.1	31.0	7.7	100.0
<u>WESTERN LARCH</u>											
25	--	--	.1	.1	.1	.1	--	0	--	0	.4
30	--	.1	.2	.6	2.4	2.5	1.0	0	.5	0	7.3
35	.4	.6	1.2	5.3	14.1	8.5	2.7	0	--	0	32.8
40	.9	1.6	5.0	14.6	11.7	2.8	--	0	0	0	36.6
45	.2	.7	3.5	5.2	1.1	--	0	0	0	0	10.7
50	.1	.6	2.1	1.1	--	0	0	0	0	0	4.0
55	1.0	2.8	4.2	.2	--	--	0	0	0	0	8.2
All	2.6	6.4	16.3	27.1	29.4	13.9	3.8	0	.5	0	100.0
<u>ALL SPECIES</u>											
25	.3	.1	.3	.5	1.2	2.1	2.8	.5	10.3	2.9	21.0
30	.2	.2	.4	.9	2.5	3.5	2.8	.5	1.7	--	12.7
35	.3	.4	2.1	4.1	8.9	6.7	2.5	--	--	0	25.0
40	.4	.8	3.8	6.0	5.9	2.4	--	0	0	0	19.3
45	.4	.8	2.8	3.6	1.5	--	--	0	0	0	9.2
50	.4	.9	1.7	1.1	.1	--	0	0	0	0	4.3
55	1.7	2.8	3.1	.9	--	--	0	0	0	0	8.5
All	3.7	6.0	14.2	17.1	20.1	14.8	8.2	1.0	12.0	2.9	100.0

<sup>1</sup> Dash (--) indicates production less than 0.05 percent.

<sup>2</sup> Zero (0) indicates no production.

Over the 16 years of record, production has declined appreciably from the high point in 1947, when pent-up demand from the war years was pushing power and telephone line construction. However, this decline has not been at a uniform rate. An analysis of the trend in output from northern Rocky Mountain forests showed that (1) nearly 89 percent of the overall decline for the 16-year period occurred before 1955, and (2) the tendency in the late 1950's has been for production to level off at an annual output of about 375,000 poles.

A similar production trend--a rapid decline from 1947 to about 1955, followed by a much less rapid decline or a tendency to level off--was found in the analysis of data from each of the three areas.

Prior to 1955, except for a single year, pole imports to northern Rocky Mountain yards exceeded the output from any one of the three areas, but later fell behind both Idaho and Montana. Since 1957, imports have declined steadily and, in 1962, fell below the output of each of the three areas. The continuing and rapid downward trend for imports is in marked contrast to the "leveling-off" tendency found in the production figures of the northern Rocky Mountain area.

### TRENDS IN POLE PRODUCTION AND IMPORTS NORTHERN ROCKY MOUNTAIN AREA 1947 - 1962

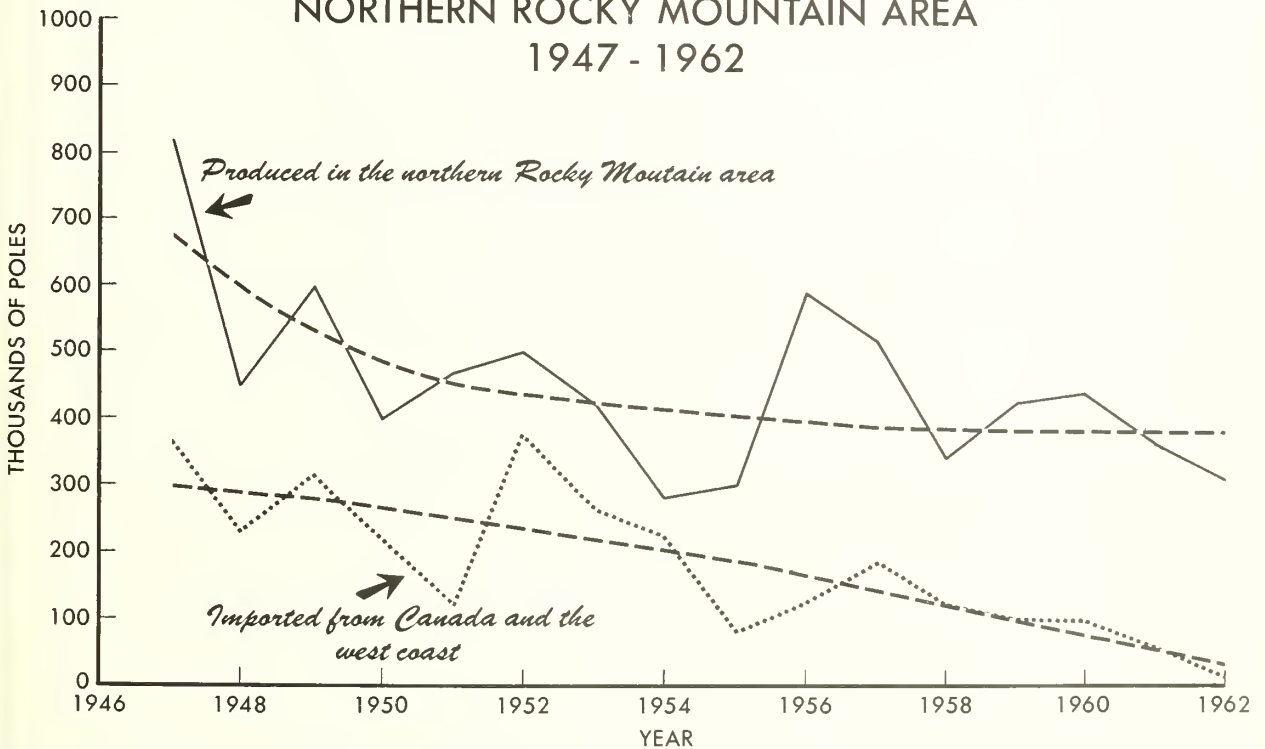

Figure 1

Average annual production was about the same for Idaho and Montana from 1947 through 1962. Idaho is estimated to have produced between 196,000 and 200,000 poles per year<sup>3</sup> in comparison to Montana's 193,000. Prior to 1955, production in Idaho was somewhat higher than in Montana. However, for most of the years since 1955, Montana's output has exceeded that of Idaho.

Western redcedar has been the leading species for all but 4 years of the 16-year period. Since 1955, however, lodgepole pine has occupied top place three times (in 1956, 1958, and 1959), and will probably challenge western redcedar with increasing frequency as a source of poles.

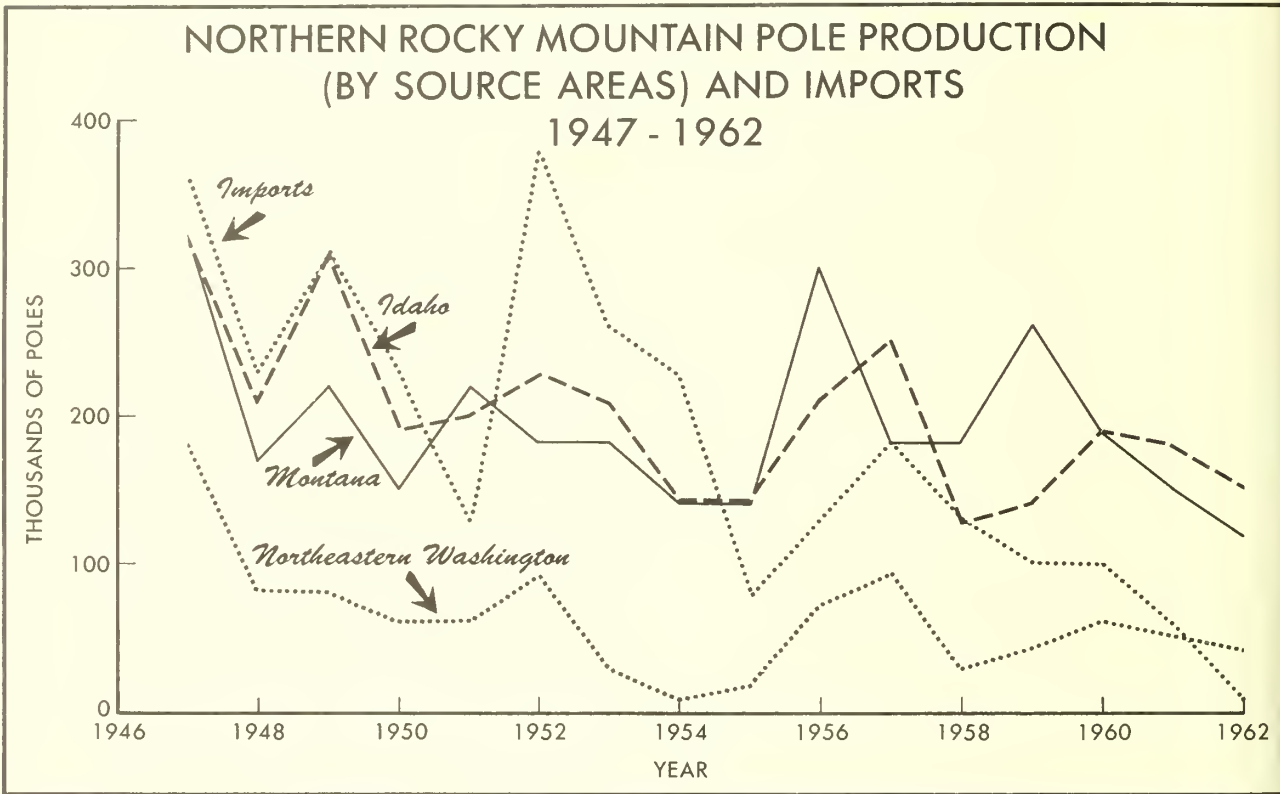

Figure 2

<sup>3</sup>Data are missing for all but one of the years from 1947 to 1955 for southern Idaho. Estimates based on 1952 and 1956 figures for southern Idaho indicate the actual production probably did not exceed the higher figure shown here.









# Research Note

UNITED STATES DEPARTMENT OF AGRICULTURE  
FOREST SERVICE

**INTERMOUNTAIN FOREST & RANGE EXPERIMENT STATION**  
OGDEN UTAH

U.S. Forest Service  
Research Note INT-10

1964

## COLORADO'S FOREST AREA AND TIMBER VOLUME

A. P. Nardi, Research Forester  
Division of Forest Economics and Recreation Research

### ABSTRACT

Completion of the first comprehensive forest inventory in 1959 revealed that Colorado had 12.3 million acres of commercial forest land, which supported 17.3 billion cubic feet of wood in sound live trees. The National Forests administer 68 percent of the commercial forest land and 82 percent of the State's sawtimber volume. Engelmann spruce is the leading species in timber volume with about 36 percent of the cubic-foot volume and 49 percent of the board-foot (sawtimber) volume.

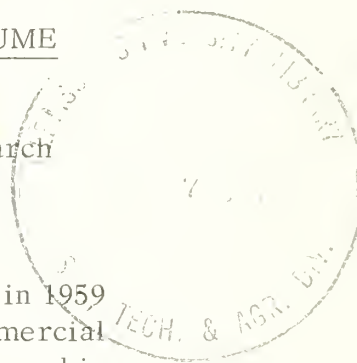

Colorado has 22.6 million acres of forest land--about one-third of the area of the State. More than one-half of this forest land, or 12.3 million acres, is commercially important for timber production. The remainder (10.3 million acres) consists of 9.8 million acres that is incapable of yielding trees of commercial size and quality, and 0.5 million acres that is productive, but is reserved from timber cuttings because it is in wilderness and primitive areas or in National Parks.

Fir-spruce, the largest commercial timber type, covers 28 percent or 3.4 million acres of commercial forest land. The aspen type is second in area with 23 percent and 2.8 million acres. Ponderosa pine, lodgepole pine, Douglas-fir, and minor types make up the remainder of the forest area with 19, 17, 12, and 1 percent, respectively.

Sawtimber stands support a volume of 46.5 billion board feet,<sup>1</sup> occupy more than one-half the commercial forest land, and average 7,317 board feet per acre. Together the sawtimber and poletimber stands cover 92 percent, or 11.3 million acres of commercial forest, and support a volume of 17.2 billion cubic feet in sound live trees 5 inches d.b.h. and larger.

<sup>1</sup> International  $\frac{1}{4}$ -inch rule.

Engelmann spruce leads in timber volume, having about 36 percent of the cubic-foot volume and 49 percent of the board-foot (sawtimber) volume.

The public owns 9.1 million acres, or almost three-quarters of the commercial forest area. The largest holdings are in the National Forests, which have 68 percent of the area and 82 percent of the sawtimber volume. Other public forest lands are principally under the administration of the Bureau of Land Management, other Federal agencies, and the State. About 85 percent of the 3.1 million acres under private ownership is in farms and ranches.

Of the 434,000 acres that is nonstocked, 61 percent is in private ownership as compared to 37 percent in National Forests and 2 percent in other public ownership.

Statistics reported here summarize some of the data collected in the first comprehensive inventory of Colorado's forests. The survey was done by the U.S. Forest Service on a cooperative basis. Participating in the survey were the Intermountain Forest and Range Experiment Station, Ogden, Utah; the Rocky Mountain Forest and Range Experiment Station, Fort Collins, Colorado; and the Rocky Mountain Region, Denver, Colorado. Fieldwork began in 1956 and was completed in 1959.

Table 1. -- Area by land classes,  
Colorado, 1959

Land class	Thousand acres
Commercial forest land <sup>1</sup>	12,275
Unproductive forest land <sup>2</sup>	9,843
Productive-reserved forest land <sup>3</sup>	465
Total forest land	22,583
Nonforest land	43,927
All land	<sup>4</sup> 66,510

<sup>1</sup> Commercial forest land. Forest land that is producing or is capable of producing crops of industrial wood and not withdrawn from timber utilization.

<sup>2</sup> Unproductive forest land. Forest land incapable of growing crops of industrial wood because of adverse site conditions.

<sup>3</sup> Productive-reserved forest land. Productive forest land withdrawn from timber utilization through statute or administrative regulation.

<sup>4</sup> From U.S. Bureau of the Census, land and water areas of the United States, 1950.

Table 2. -- Area of commercial forest land  
by ownership classes, Colorado, 1959

Ownership class	Thousand acres
National Forest	8,384
Other Federal:	
Bureau of Land Management	415
Indian	103
Miscellaneous Federal	5
Total other Federal	523
State	190
County and municipal	45
Farmer-owned	2,649
Other private	484
All ownerships	12,275

The forest inventory of Colorado was designed to give sampling errors at the one standard error level of not more than  $\pm 3$  percent per million acres of commercial forest land,  $\pm 10$  percent per million acres of noncommercial forest land, and  $\pm 10$  percent per billion cubic feet of growing stock on commercial forest land.

A more comprehensive analytical report for the State will be published later this year.

Table 3.--Area of commercial forest land by stand-size and ownership classes, Colorado, 1959

Stand-size class	All ownerships	National Forest	Other public	Farmer and other private
----- Thousand acres -----				
Sawtimber stands <sup>1</sup>	6,352	4,640	431	1,281
Poletimber stands <sup>2</sup>	4,990	3,240	300	1,450
Sapling and seedling stands <sup>3</sup>	499	342	20	137
Nonstocked areas <sup>4</sup>	434	162	7	265
All classes	12,275	8,384	758	3,133

<sup>1</sup> Sawtimber stands. Stands at least 10 percent stocked with growing stock trees with a minimum net volume per acre of 1,500 board feet (International  $\frac{1}{4}$ -inch rule) in sawtimber trees (11.0 inches d.b.h. and larger).

<sup>2</sup> Poletimber stands. Stands failing to meet the sawtimber stand specifications, but at least 10 percent stocked with poletimber and larger (5.0 inches d.b.h. and larger) trees and with at least half the minimum stocking in poletimber trees.

<sup>3</sup> Sapling and seedling stands. A stand not qualifying as either a sawtimber or poletimber stand, but having at least 10 percent stocking of trees of commercial species and with at least half the stocking in sapling and seedling trees (less than 5.0 inches d.b.h.).

<sup>4</sup> Nonstocked area. An area not qualifying as a sawtimber, poletimber, or a sapling-seedling stand; i.e., normally an area less than 10 percent stocked.

Table 4.--Area of commercial forest land, by forest types and ownership classes, Colorado, 1959

Forest type	All ownerships	Public ownerships	Private ownerships
----- Thousand acres -----			
Douglas-fir	1,451	1,056	395
Ponderosa pine	2,347	1,180	1,167
Lodgepole pine	2,068	1,693	375
Whitebark and limber pine	139	98	41
Fir-spruce	3,393	3,067	326
Aspen	2,794	2,025	769
Cottonwood	83	23	60
All types	12,275	9,142	3,133

Table 5. -- Volume of growing stock and sawtimber on commercial forest land by species, Colorado, 1959

Species	:	Growing stock <sup>1</sup>	:	Sawtimber
		Thousand cubic feet		Thousand board feet <sup>2</sup>
Softwoods:				
Douglas-fir		1,590,020		5,410,917
Ponderosa pine		1,017,582		3,782,679
Lodgepole pine		3,285,955		6,024,361
Whitebark and limber pine		188,708		472,091
True firs <sup>3</sup>		2,408,661		6,796,548
Engelmann spruce		6,201,299		25,592,261
Blue spruce		202,489		871,002
Other softwoods		2,233		--
Total		14,896,947		48,949,859
Hardwoods:				
Aspen		2,358,146		3,482,444
Cottonwood		75,701		287,447
Other hardwoods		5,812		11,306
Total		2,439,659		3,781,197
All species		17,336,606		52,731,056

<sup>1</sup> Growing-stock volume. Net volume in cubic feet of live merchantable sawtimber trees and poletimber trees from stump to a minimum 4.0-inch top inside bark.

<sup>2</sup> International  $\frac{1}{4}$ -inch rule.

<sup>3</sup> Subalpine and white fir.

Table 6. -- Volume of growing stock and sawtimber on commercial forest land by ownership classes, Colorado, 1959

Ownership class	:	Growing stock	:	Sawtimber
		Thousand cubic feet		Thousand board feet <sup>1</sup>
National Forest		13,795,802		43,231,074
Other public		781,646		2,171,947
Private		2,759,158		7,328,035
All classes		17,336,606		52,731,056

<sup>1</sup> International  $\frac{1}{4}$ -inch rule.

Table 7. -- Volume of growing stock and sawtimber on commercial forest land by stand-size classes, Colorado, 1959

Stand-size class	:	Growing stock	:	Sawtimber
		Thousand cubic feet		Thousand board feet <sup>1</sup>
Sawtimber stands		12,562,473		46,477,416
Poletimber stands		4,634,772		6,052,071
Sapling and seedling stands		106,759		82,707
Nonstocked areas		32,602		118,862
All classes		17,336,606		52,731,056

<sup>1</sup> International  $\frac{1}{4}$ -inch rule.



# Research Note

UNITED STATES DEPARTMENT OF AGRICULTURE  
FOREST SERVICE

**INTERMOUNTAIN FOREST & RANGE EXPERIMENT STATION**  
OGDEN UTAH

J.S. Forest Service  
Research Note INT-11

1964

## FLOW METER FOR MEASURING GROUND WATER SEEPAGE FROM ROAD CUTS

Edward R. Burroughs, Jr., Hydraulic Engineer  
Watershed Management Research

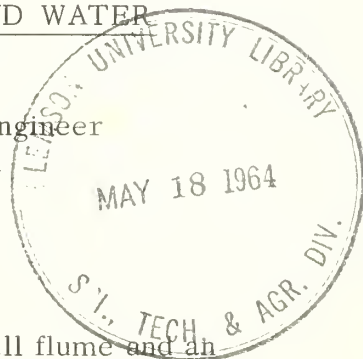

### ABSTRACT

A flow meter, consisting of a small Parshall flume and an attached water level recorder, has been developed to continuously record ground water seepage from road cut banks. For low flow rates, inserts in the flume throat convert the Parshall flume to an orifice-type flow meter. The flow meter can easily register changes in ground water discharge caused by evapotranspiration.

### INTRODUCTION

Roads constructed in steep mountainous terrain necessarily expose large areas of cut banks. If located in a high-precipitation zone, such as the Engelmann spruce-alpine fir forest in Idaho, the exposed cut banks may drain a considerable volume of ground water.<sup>1</sup>

<sup>1</sup> Burroughs, E. R., Jr., and P. E. Packer. The effects of logging roads and timber cutting on the soil mantle hydrology of a spruce-fir forest. 1961. (Unpublished study plan on file at the Intermountain Forest and Range Experiment Station.)

In the systematic study of soil mantle hydrology, a metering device was needed to record cut bank seepage flow. The flow meter had to satisfy the following specifications:

1. Accurate over a wide range of flow rates.
2. Able to handle debris-laden water.
3. Able to operate for periods up to 1 week without maintenance.
4. Compact in design, allowing installation on the inside of the road, without interfering with vehicular traffic.

A small Parshall flume appeared to best fulfill the specifications. Plans developed by Robinson<sup>2</sup> at Colorado State University give dimensions for Parshall flumes with throat widths of 1, 2, and 3 inches. Both 1- and 2-inch flumes were installed for this study.

### INSTALLATION

A typical installation, located at the lower end of a galvanized sheet metal trough, collects seepage from 100 feet of road cut bank (figs. 1 and 2). Between the collection trough and the flume is an 8- by 10- by 48-inch metal stilling section with wooden baffles in the bottom to trap sediment from earthslides and to reduce the approach velocity of water from the trough. For accurate measurements, the flume floor in the converging section must be level. This is best accomplished by inserting shims between the horizontal angle irons and the top of the flume walls (fig. 1). A short piece of  $\frac{1}{2}$ -inch copper tubing is soldered into the flume wall, and another into the stilling well; the flume and well are then connected by plastic hose one-half inch in inside diameter.

A section of culvert pipe 2 feet in diameter and 3 feet long forms the stilling well. Its concrete bottom, sealed against leakage, is bolted to a 24- by 15- by 10-inch concrete base with two 9- by  $\frac{3}{8}$ -inch bolts. A 1- by 1- by  $\frac{1}{8}$ -inch angle iron superstructure is mounted in the concrete base, to which a  $\frac{3}{4}$ -inch exterior grade plywood deck is bolted. The water level recorder is positioned on the deck with the float pulley directly over the stilling well (fig. 2). The recorder clock weight operates in a length of capped galvanized stovepipe that prevents earthslides from interfering with the fall of the weight.

---

<sup>2</sup> Robinson, A. R. Parshall measuring flumes of small sizes. Colorado State Univ. Tech. Bull. 61, 12 pp. 1957.

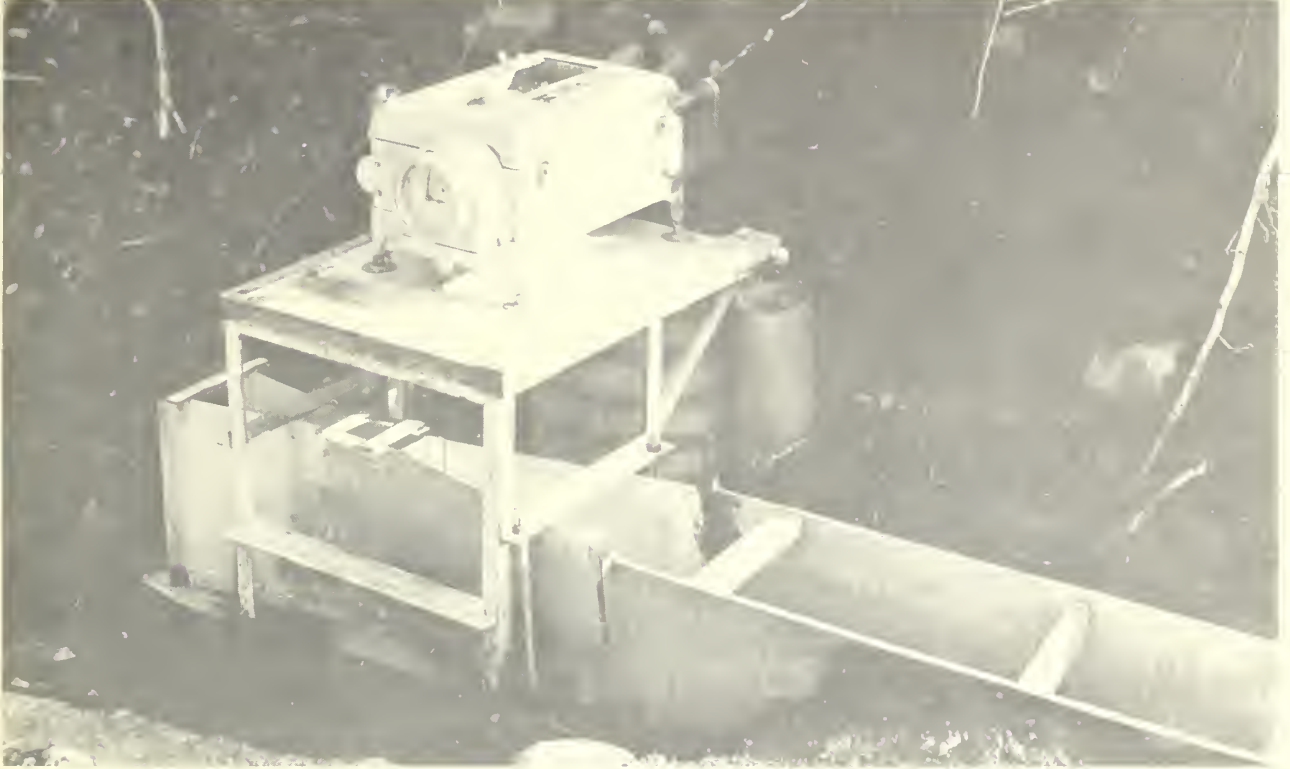
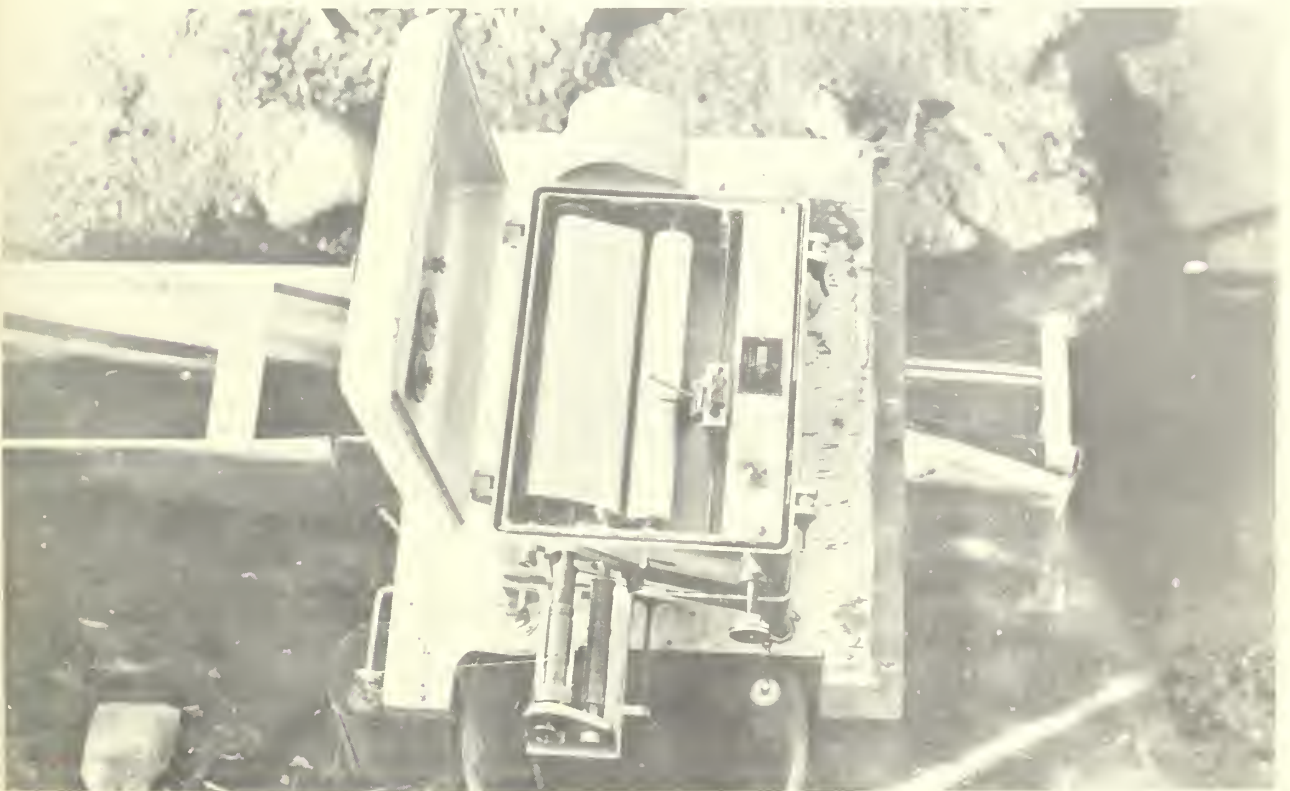

Figure 1.--General view of flow meter installation.  
Note metal stilling section preceding the flume.  
Figure 2.--Vertical view of flow meter installation.



## OPERATION AND CALIBRATION

Two seasons' experience with this installation has demonstrated that when the head on the Parshall flume drops to 1 inch, its throat must be modified to permit continued accurate measurement of seepage flow. To modify the flume, its throat is reduced by using a graduated series of orifices, made in sheet aluminum inserts. The center of each orifice must be at least 1 inch above the bottom of the flume. An 8- by 8-inch piece of aluminum window screen in the flume's conveying section prevents submerged debris from plugging the orifice.

Head-discharge tables are given in Robinson's Technical Bulletin 61; however, small changes in dimensions, unavoidable during manufacture, make it advisable to field calibrate the flume. Careful field calibration of each orifice insert is an absolute necessity for accurate measurements. A series of volumetric flow measurements, taken as ground water discharge decreases, and corresponding head readings for each orifice will serve to define the head-discharge curve. Once head-discharge relations are known, templates can be made that, when laid on the recorder roll chart, will permit direct reading of discharge rates.

## MAINTENANCE

Periodic maintenance on the installation is quickly and easily performed. The wooden baffles in the stilling section may be removed as required and accumulated sediment flushed through the flume. The hose connecting the stilling well and flume is large enough to pass silt and sand without causing erroneous readings. As a precaution, the float can be raised and lowered in the well to surge water through the hose and flush out sediment. This is done routinely whenever the recorder clock is rewound. Moreover, the head recorded on the roll chart can be checked at that time against head measured at the flume end of the hose connection.

A galvanized metal cover protects the recorder from weather. Plywood covers are placed over the stilling well and clock well openings when the installation is closed for the winter. The recorder can be sealed and left in place under its metal cover over winter, if logs are placed alongside the metal cover to bear the weight of snow. The roll chart should always be removed during the winter to prevent damage by condensation. The winterized installation can quickly be made operable for measurements of spring snowmelt.

## CONCLUSION

This flow meter for measuring ground water seepage from road cut banks is easily built, operated, calibrated, and maintained. It measures small seepage flows continuously and accurately. For example, the flow meter records (1) slight increases in discharge caused by rainfall in the collecting trough and (2) definite diurnal fluctuations in seepage flow, from which a researcher can estimate evapotranspiration for the tributary area.





# Research Note

UNITED STATES DEPARTMENT OF AGRICULTURE  
FOREST SERVICE

**INTERMOUNTAIN FOREST & RANGE EXPERIMENT STATION**  
OGDEN UTAH

U.S. Forest Service  
Research Note INT-12

1964

## CONVERSION TABLES FOR USE WITH THE NATIONAL FIRE-DANGER RATING SYSTEM IN THE INTERMOUNTAIN AREA

Dwight S. Stockstad and Richard J. Barney, Research Foresters  
Division of Forest Fire Research

### ABSTRACT

Two tables prepared for use with the National Fire-Danger Rating System replace 10 tables previously used with the Model-8 Fire-Danger Rating System. They provide for the conversion of Spread Index values at various altitudes, aspects, and times of day. A rate of spread table facilitates converting Spread Index values to chains per hour of perimeter increase for various fuel types and slope steepness.



J. S. Barrows' publication on fire behavior in Northern Rocky Mountain forests<sup>1</sup> was a major contribution to better understanding of forest fire behavior. It included tables for predicting spread rate of fires and for conversion of Burning Index values at various altitudes, aspects, and times of day. The text and accompanying tables (A-8

---

<sup>1</sup> Fire behavior in northern Rocky Mountain forests. Northern Rocky Mountain Forest and Range Expt. Sta. Paper 29, 103 pp., illus. 1951. (Out of print)

through A-16) were designed to be used with the Model-6 Fire-Danger Rating System and were subsequently used with the Intermountain Model-8 Fire-Danger Rating System. George Fahnestock prepared instructions for use of these tables and added tables A-17 through A-19 for conversion of Burning Indexes.<sup>2</sup>

Adoption of the National Fire-Danger Rating System in Forest Service Regions 1 and 4 and discontinuance of the Model-8 System necessitated the preparation and adoption of new tables. The three tables printed here provide conversions for altitude, aspect, and time of day as well as relative rate of spread for various fuel types and classes of slope steepness.

Tables 1 and 2 provide conversion factors for the calculated Spread Index to adjust for different altitudes, aspects, and times of day. These two tables replace Barrows' tables A-8 through A-15 and Fahnestock's tables A-17 through A-19, respectively. Table 1 lists conversion factors for Spread Indexes obtained at "valley bottom" stations when projected to locations in the "lower 1/3 slope," the "thermal belt or middle 1/3 slope," and the "upper 1/3 slope." Table 2 lists conversions for Spread Indexes obtained at "mountaintop" stations when projected downward to locations in the "upper 1/3 slope," the "thermal belt," and the "lower 1/3 slope."

The provision in Barrows' and Fahnestock's tables for projecting conversions for longer than an 8-hour period each hour of the day has been discontinued. Spread Index calculations revealed differences in hourly changes to be insignificant and that conversions based on a 4-hour period extended for a 12-hour span would be adequate. This 12-hour projection was selected as being the maximum necessary to assist in fire control planning. For periods longer than 12 hours, the daily fire-weather forecast or a current fire-weather observation can be the basis for a revised, up-to-date conversion. The revised tables were also limited to the 0800, 1000, 1200, 1400, 1600, and 1800 observation times. Spread Index calculations indicated the conversions made at more frequent or additional observation times were insignificant and served only to complicate the tables. All calculations for Spread Index conversions were made from the original data of G. Lloyd Hayes<sup>3</sup> as Barrows and Fahnestock had done for the Burning Index conversions.

---

<sup>2</sup> Correction of Burning Index for the effects of altitude, aspect, and time of day. Northern Rocky Mountain Forest and Range Expt. Sta. Res. Note 100, 4 pp. 1951. (Out of print)

<sup>3</sup> Influence of altitude and aspect on daily variations in factors of forest-fire danger. U.S. Dept. Agr. Cir. 591, 39 pp., illus. 1941.

Table 1. --Spread Index conversions from valley bottom station to other altitudes, aspects, and times of day

Slope position	Time of observation	Conversion factor for projected time and aspect <sup>1</sup>							
		0 hrs.		4 hrs.		8 hrs.		12 hrs.	
		N	S	N	S	N	S	N	S
Lower 1/3 slope	0800	-5	+5	+10	+21	+8	+23	+4	+10
	1000	-5	+7	-1	+9	-6	+2	-11	-5
	1200	-7	+4	-9	+6	-13	-7	-19	-13
	1400	-5	+5	-10	-2	-15	-9	-18	-13
	1600	-8	+7	-12	-6	-18	-13	-21	-16
	1800	-2	+6	-7	-1	-10	-5	-13	-8
Thermal belt	0800	+1	+9	+7	+21	+8	+17	+7	+7
	1000	-8	+7	-4	+9	-5	0	-8	-5
	1200	-10	+4	-9	0	-10	-10	-13	-10
	1400	-8	+5	-9	-4	-12	-9	-12	-9
	1600	-8	+1	-9	-9	-12	-9	-12	-12
	1800	-1	+4	-4	-1	-4	-1	-7	-1
Upper 1/3 slope	0800	+7	+9	+11	+14	+15	+15	+7	+9
	1000	-3	-1	+3	+7	0	0	-5	-3
	1200	-6	-3	-2	-2	-10	-8	-10	-8
	1400	-1	+3	-4	-4	-9	-7	-9	-7
	1600	-1	-1	-9	-7	-9	-7	-12	-7
	1800	+4	+4	-1	+1	-1	+1	-5	-3

<sup>1</sup>Spread Index will vary as indicated 0, 4, 8, and 12 hours after observation time. For East aspect conversions use North column and for West aspects use South column.

Instructions:

1. Select time of Spread Index measurement in valley bottom.
2. To estimate Spread Index at another location at the same time measurement is taken, read conversion for proper aspect in 0 hour column.

Example: At 0800, Spread Index in valley bottom is 38. At the same time the estimated Spread Index on the upper 1/3 south slope is 38+9 or 47.

3. To estimate Spread Index for a given number of hours at another location, read conversion for proper aspect in column showing length of estimate in hours.

Example: At 1200, Spread Index in valley bottom is 49. Spread Index 8 hours later on the lower 1/3 south slope is 49-7 or 42.

Table 2.--Spread Index conversions from mountaintop station to other altitudes, aspects, and times of day

Slope position	Time of observation	Conversion factor for projected time and aspect <sup>1</sup>							
		0 hrs.		4 hrs.		8 hrs.		12 hrs.	
		N	S	N	S	N	S	N	S
Upper 1/3 slope	0800	0	+2	+4	+7	+8	+8	0	+2
	1000	0	+2	+6	+10	+3	+3	-2	0
	1200	0	+3	+4	+4	-4	-2	-4	-2
	1400	0	+4	-3	-3	-8	-6	-8	-6
	1600	0	0	-8	-6	-8	-6	-11	-6
	1800	0	0	-5	-3	-5	-3	-9	-7
Thermal belt	0800	-6	+2	0	+14	+1	+10	0	0
	1000	-5	+10	-1	+12	-2	+3	-5	-2
	1200	-4	+10	-3	+6	-4	-4	-7	-4
	1400	-7	+6	-8	-3	-11	-8	-11	-8
	1600	-7	+2	-8	-8	-11	-8	-11	-11
	1800	-5	0	-8	-5	-8	-5	-11	-5
Lower 1/3 slope	0800	-12	-2	+3	+14	+1	+16	-3	+3
	1000	-2	+10	+2	+12	-3	+5	-8	-2
	1200	-1	+10	-3	+12	-7	-1	-13	-7
	1400	-4	+6	-9	-1	-14	-8	-17	-12
	1600	-7	+8	-11	-5	-17	-11	-20	-15
	1800	-6	+2	-11	-5	-14	-9	-17	-12

<sup>1</sup> Spread Index will vary as indicated 0, 4, 8, and 12 hours after observation time. For East aspect conversions use North column and for West aspects use South column.

Instructions:

1. Select time of Spread Index measurement on mountaintop.
2. To estimate Spread Index at another location at same time measurement is taken, read conversion for proper aspect in 0 hour column.

Example: At 0800, Spread Index at mountaintop is 24. At the same time the estimated Spread Index on the lower south slope is 24-2 or 22.

3. To estimate Spread Index for a given number of hours later at another location, read conversion for proper aspect in column showing length of estimate in hours.

Example: At 1200, Spread Index at mountaintop is 38. The Spread Index 8 hours later on the south thermal belt aspect will be 38-4 or 34.

A revised spread table (table 3) for converting Spread Index values to perimeter increase in chains per hour by fuel type and slope steepness was also prepared. The basic data for Barrows' table A-16 are still the only available data on rate of spread for this area. The entry into table A-16 was partially controlled by the current, projected, or predicted Burning Index; therefore, the entry values had to be shifted to agree with the relations of the National Spread Index to the Model-8 Burning Index. The National Spread Index was divided into 10 classes to correspond to the Burning Index groupings, e.g., 1-10, 11-20, ... 91-100. The midpoints of these groups were then used to obtain the adjusted numbers for entry in table 3. This kind of transformation made it possible to continue using the existing rate of spread data in terms of the National System. Additional studies are needed to verify Spread Index conversions and rates of fire spread.

The three tables in this paper should provide the working tools necessary for altitude and aspect conversions as well as for predictions for rates of fire spread. The values given in the tables should be interpreted as being relative rather than absolute. These tables can be a valuable guide for consistent dispatching, intelligent planning, and other fire control operations.

Table 3.--Average initial rate of spread<sup>1</sup> according to fuel type, slope steepness, and spread index at site of fire<sup>2</sup>

Fuel rate of spread type	Slope steepness <sup>3</sup>	Spread Index									
		1-10	11-20	21-30	31-40	41-50	51-60	61-70	71-80	81-90	91-100
	Percent	----- Perimeter increase (chains per hour) -----									
Low	0-10	0	1	1	1	2	2	2	3	3	4
	11-25	1	1	1	2	2	3	3	4	5	6
	26-50	1	2	2	3	3	4	4	5	6	9
	51-75	2	3	3	4	5	6	6	8	10	14
	Over 75	3	4	5	6	7	8	9	12	16	21
Medium	0-10	1	1	1	2	2	2	3	3	4	5
	11-25	1	1	2	2	3	3	4	5	6	7
	26-50	2	2	3	3	4	5	6	7	8	11
	51-75	3	3	4	5	6	7	8	11	13	17
	Over 75	4	5	6	8	9	11	14	17	21	27
High	0-10	1	2	3	4	5	6	7	8	10	13
	11-25	1	3	4	6	7	8	10	12	14	18
	26-50	2	4	6	8	9	11	14	16	20	25
	51-75	3	6	9	12	15	18	22	26	30	40
	Over 75	6	10	15	19	24	28	35	42	49	63
Extreme	0-10	3	4	5	6	7	9	12	14	17	20
	11-25	4	6	7	9	10	13	17	20	23	28
	26-50	6	8	10	12	15	19	23	28	33	40
	51-75	9	11	16	19	23	30	36	44	53	62
	Over 75	16	20	25	30	37	46	58	71	84	97
Flash	0-10	6	12	15	18	23	28	33	40	50	61
	11-25	8	18	21	26	32	39	48	58	69	84
	26-50	11	25	30	37	45	55	67	81	97	119
	51-75	18	39	48	58	71	88	106	128	155	188
	Over 75	29	62	75	92	113	138	168	202	244	300

<sup>1</sup>Average initial rate of spread refers to perimeter increase between discovery of fire and first attack. This rate of spread may be anticipated during the first 4 to 5 hours.

<sup>2</sup>This table was based on table A-16, NRM Station Paper No. 29, "Fire Behavior," by J. S. Barrows.

<sup>3</sup>General designations used in classifying slope descriptions (column 2) are: Level, 0-10 percent; Gentle, 11-25 percent; Moderate, 26-50 percent; Steep, 51-75 percent; Very Steep, over 75 percent.









# Research Note

UNITED STATES DEPARTMENT OF AGRICULTURE  
FOREST SERVICE

**INTERMOUNTAIN FOREST & RANGE EXPERIMENT STATION**  
OGDEN UTAH

U.S. Forest Service  
Research Note INT-13

1964

## FUEL MOISTURE--A GUIDE FOR EVALUATING SEVERITY OF FIRE SEASONS

Richard J. Barney, Research Forester  
Division of Forest Fire Research

### ABSTRACT

Field personnel in all forest fire protection agencies need some simple but reasonably accurate method for evaluating severity of the fire season as it progresses and of comparing severity of the current season with that of preceding fire seasons. This paper proposes use of records of average fuel moisture percentages cumulated continuously for 5-day periods throughout successive fire seasons. Records for all seasons must start on the same calendar day. Beginning and closing dates should be selected so as to enable complete recording of buildup to and recovery from the peak of each season's severity.

The paper describes two systems for graphing cumulated fuel moisture percents so as to facilitate comparison. It also tells how to interpret the resulting curves--the relation of segments within a curve, and the relation of the current season's curve to earlier records--and points out unavoidable limitations of the proposed systems.

### INTRODUCTION

For many years fire control personnel have been attempting to devise methods for comparing severity of successive fire seasons. As values of forest and range lands increase, fire control becomes correspondingly more important. As any fire season advances, some measure of its development and increase of severity becomes extremely important in anticipating problems and preparing to solve them. Also, some measure of seasonal severity is useful in evaluating the efficiency of the fire control organization. For several years, Intermountain area fire protection agencies have used the Model-8 Burning Index Meter to predict and evaluate daily burning conditions and a component of this meter, Severity Index, to arrive at a measure of relative buildup.<sup>1</sup> Other regions have danger rating systems that perform similar functions. In using any danger rating system, judgment must be exercised in making many decisions related to fire presuppression and suppression activities.

<sup>1</sup>Buildup: Cumulative effects of drying (during preceding period) on current fire danger.

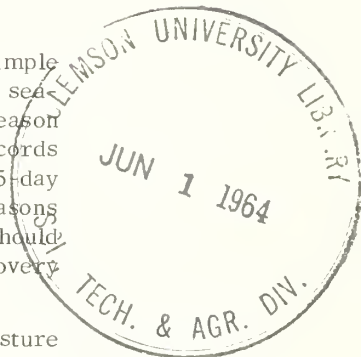

## OBJECTIVES

This paper outlines and explains a system for evaluating fire season development and for rating severity. The system was originally designed to supplement the Intermountain Fire-Danger Rating System; however, the principles and methods discussed can be applied to most existing danger rating systems. The system described here can be used in conjunction with the National Fire-Danger Rating System when it is adopted locally. The specific capabilities and intent of this system are:

1. To provide a simple, practical guide that may be used by field personnel to:
  - a. Assist in tempering judgment.
  - b. Aid in accurately comparing one fire season to another.
  - c. Aid in evaluating fire season buildup and potential.
2. To provide a longer and more nearly adequate period of season rating coverage.
3. To utilize available records with the minimum of conversion and calculation.

## METHOD

Fuel moisture percents, as obtained from the  $\frac{1}{2}$ -inch fuel-moisture-indicator sticks,<sup>2</sup> are the basic component. Fuel moisture percents determined by other methods may also be used. The basic assumption of this system is that the drier the fuel condition and the more fuel that is available to burn, the greater is the potential severity of a given season. A potentially severe season becomes a reality only if natural or human agents start fires.

Fuel moisture percents, as recorded from daily measurements throughout the fire season, are cumulated by 5-day groups. Then, using measurements from as many years as possible, an average<sup>3</sup> 5-day cumulated fuel moisture can be computed. Increments of 5 days are used in cumulating fuel moisture percents to reduce the total number of figures. Larger increments could be used; however, doing so decreases sensitivity. Ideally the period of May 1 through October 31 would cover the fire season in the Intermountain area, showing both buildup and recovery. For this presentation, fuel moisture percents for the period of June 1 through September 30 are used.

A graph of the computed average 5-day cumulative fuel moisture percent shows a climbing curve; this is to be expected when plotting successive cumulated totals. Each fire-weather station would have its own characteristic curve. Figure 1 shows these curves for four selected fire-weather stations in Forest Service Region 1. An easy method of comparing the severity of any season to that of the computed average season would be to draw curves for both seasons on the same graph; this would show whether the cumulated moisture for the year in question was above, below, or about the average. The chief drawback to this method is that it requires a comparatively large graphic scale to show changes for each 5-day period.

An alternate method of graphing, which seems better suited for general administrative use, requires that the average 5-day cumulative fuel moisture percent be plotted as a straight horizontal line and that the average be considered as 100 percent. The period being compared is then related as a percent of the

---

<sup>2</sup> Specially prepared sticks or sets of sticks of known dry weight continuously exposed to the weather and periodically weighed to determine changes in moisture content as an indication of changes in moisture in forest fuels.

<sup>3</sup> The term "average" as used in this paper is the arithmetic mean. The arithmetic mean was chosen because it is the most commonly used average, the most easily understood, the easiest to compute, and requires only total values and numbers. The disadvantage of this method is that its value may be greatly distorted by extreme values; therefore, it may not be typical. This is why it is extremely important to use as many years' data as are available to help avoid overinfluence by unusually wet or dry years. Including more years' data in the average tends to reduce the effect of any extremes.

average. To represent the computed relationship graphically, the horizontal axis of the graph represents calendar date; the vertical axis represents percent. The curve immediately tells whether the current cumulated fuel moisture for the present season is above or below average, whether the season is getting wetter or drier, and at what rate changes are occurring. In figure 2, the curves for percent of average are shown for 1960, 1961, and 1962 for the same four fire-weather stations shown in figure 1.

### INTERPRETATION AND APPLICATION

Once the 5-day cumulated fuel moisture as a percent of average has been calculated, what can be done with it, and how can it be used?

Some interpretation is necessary before any application can be made. The percent-of-average curve has three basic characteristics that are tempered by curve position. The curve for any year being compared to the average is either climbing, falling, or parallel to the average line; and is either above, below, or on this line. Each of these conditions has a definite meaning and can be interpreted. The position of the curve at any point in relation to the average line is determined by antecedent conditions of fuel moisture. If the curve is above the average line, the cumulated fuel moisture has been greater than is usually expected under average conditions. Thus, when the curve falls below the average line, the cumulated fuel moisture has been less than average.

Generally, in any fire season anywhere in the Intermountain West, high fuel moistures in the spring are followed by a drying period during the summer. In the fall, rain and snow cause a wetting or recovery from the summer drying. Figure 3 shows the relation of fuel moisture to season that usually exists in the area represented by the four stations shown in figures 1 and 2.

Local relations of season to fuel moisture must be considered when evaluating the percent-of-average curve for any year. Such relations necessarily vary by locations. The percent-of-average curve indicates not only the difference in cumulated fuel moisture but also the rate at which this difference occurs.

A climbing curve, regardless of whether it is above or below the average line, indicates that fuel moisture is cumulating at a rate faster than normal (see fig. 4, left). This tells us that the location being observed is going through a wetting period or a period when the fuel is drying at a slower rate than is usually expected for that period. Steepness of the slope of the curve must also be considered; the steeper the climb the more rapid the wetting or the slower the drying as related to average.

A falling curve indicates the opposite of a climbing curve (see fig. 4, right). The greater the drop the greater the drying; or, depending on the general season, the slower the wetting as compared to the average. Here again, steepness of slope of the curve is important. The steeper the slope, the faster the change as related to normal.

A parallel curve shows that the recording location is experiencing a period when the rate of fuel moisture cumulation is the same as the average rate. Either the loss or gain of moisture during the period when the curve parallels the average line is the same as the rate normally experienced for that same time

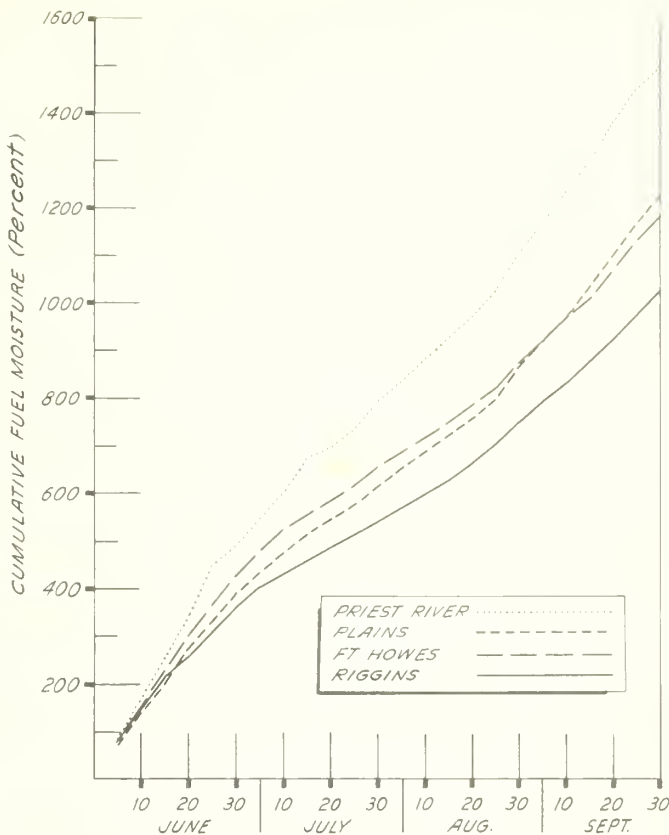
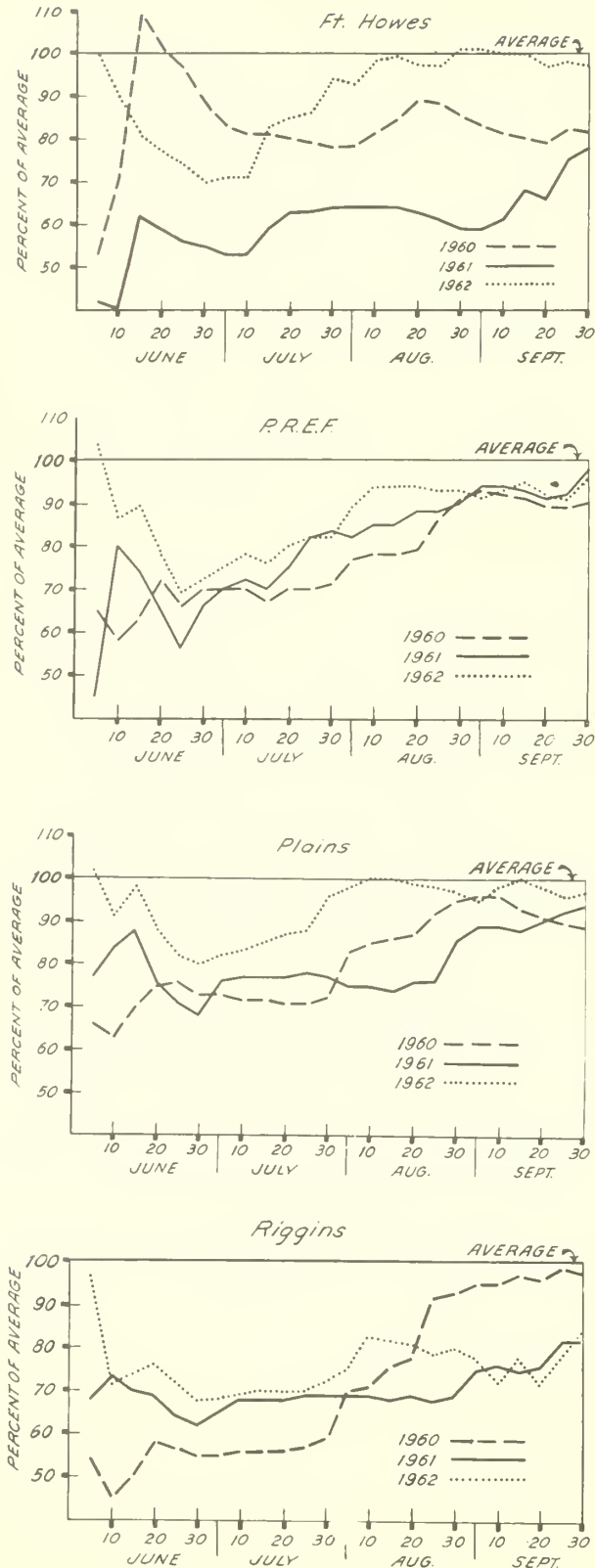

Figure 1.--Average 5-day cumulative fuel moisture curves for four fire-weather stations in Forest Service Region 1.



of year. Whether the parallel portion of the curve is above or below the average line is determined by the moisture situation preceding the period being compared.

The position of the curve at the beginning of the season is important because it indicates whether the season started above, below, or at normal (average) fuel moisture conditions. The trend of succeeding readings is also important because it indicates how the season is progressing, whether the potential fire danger is increasing, and how severity of the present season compares with the average severity for the given location.

This type of information about severity trends can be very useful to fire control agencies. If the current season's curve starts at a point below average and continues to drop, an early and a long fire season is indicated unless something happens to reverse the trend. On the other hand, if the curve for the current season starts at a point above average and continues to rise, it indicates a shorter or less severe season. Some unusual weather condition is necessary to bring the cumulative moisture curve back to normal once it has been established above or below the average line. When any segment of the current season's curve falls or rises markedly or closely parallels the "average" line, the preceding section of curve must be evaluated to aid in weighting the effect of the latest trend. For example, if the curve during July dips downward sharply and the preceding portion of the curve was climbing above the average line, the present situation is less critical than if that same dip were occurring following a downward trend below average.

Figure 2.--Five-day cumulative fuel moisture as a percentage of average for four fire-weather stations in Forest Service Region 1.

Figure 3.--Relation of season to fuel moisture in Forest Service Region 1.

The period being compared to the average may be any length desired--10 days, 2 weeks, 1 month, or 3 months. Figure 5 shows a comparison on a monthly basis. A word of caution: the seasonal trend should be evaluated in order to temper the results of this type of comparison.

SUMMARY

As stated above in "Objectives," this system is intended merely to aid in situations where personal judgment must be exercised in making fire-control decisions. The system is based on the assumption that potential severity of any fire season is related directly to cumulated moisture; the corollary assumption is that the drier the season the greater is its potential severity. We cannot now prescribe limits to show when a certain percentage of average is "critical" or "easy." However, the curves point out buildups, recoveries, and their rates, all of which might be unnoticed in using other methods. When fuel moisture percents are below average at the beginning of a season and continue to drop, a potentially bad season is imminent. The season becomes severe only if high natural and human risks are in evidence. It is also easy to tell how far above or below average a season is on any given date. Also, the curve for a season might start below average and parallel the average line, indicating that the trend is similar to normal but that the season started in drier condition. This suggests that the area of the recording station will have a longer than usual dry period if no rain falls before the latter part of the fire season.

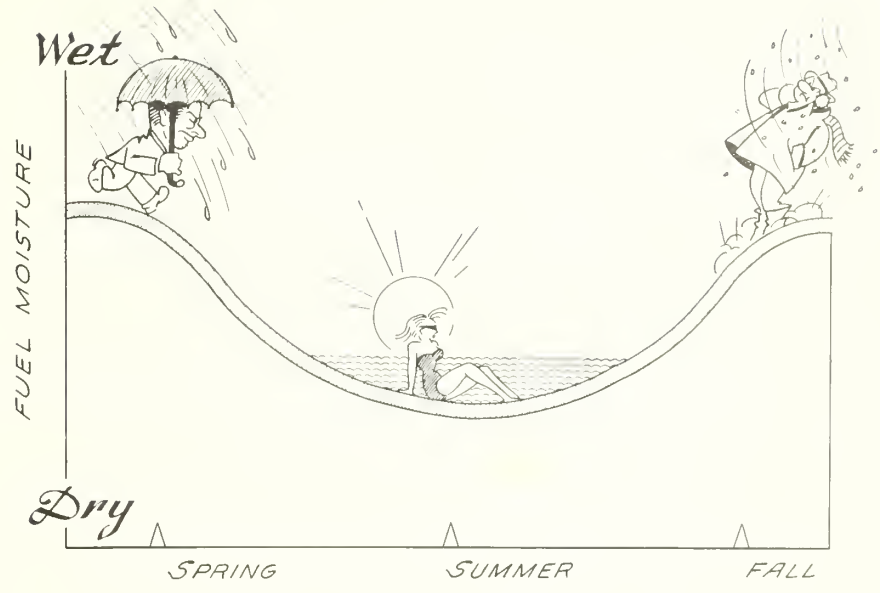

This system should be used only as a means for evaluating severity of the current season as basis for making decisions. Spread index alone does not necessarily show early or late buildup or the drying of forest

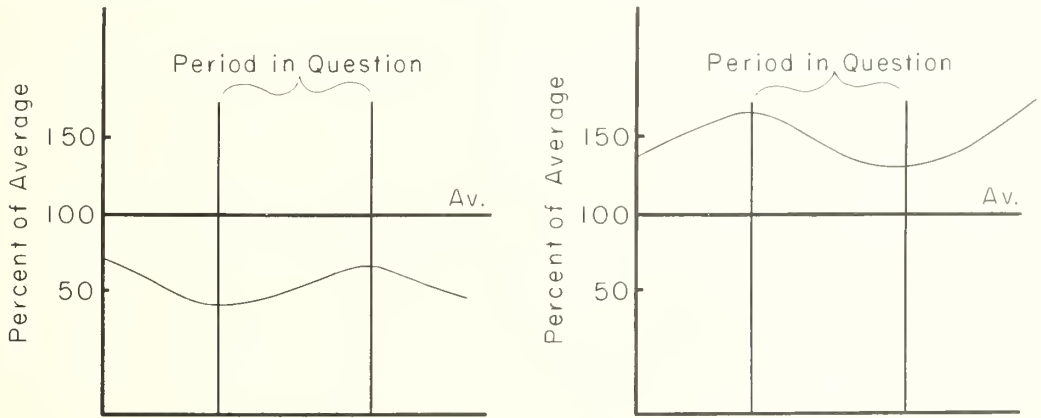
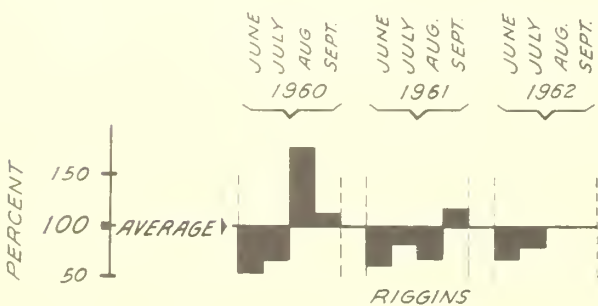
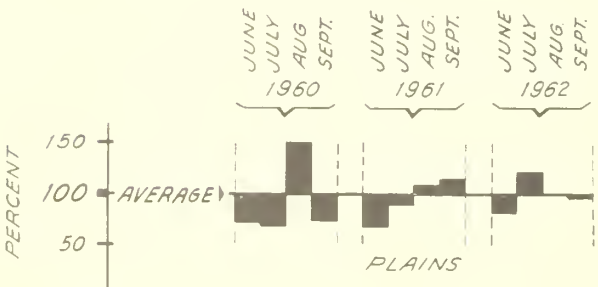
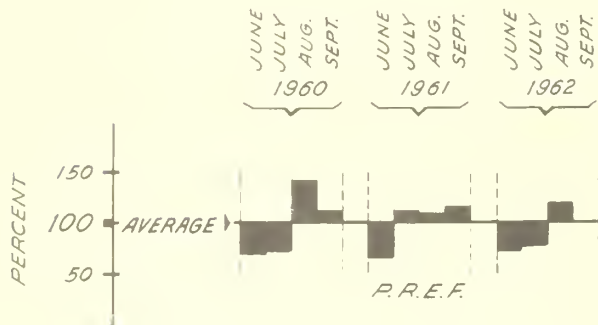
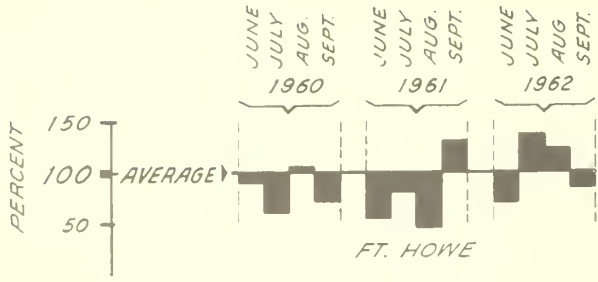

Figure 4.--Comparison of an individual time period to the cumulated fuel moisture as a percent-of-average curve: Left, Drier than average year with wetter than average period; right, wetter than average year with drier than average period.



and range fuels. An early buildup indicates that all fuels are drying. The additional drying of larger fuels increases the amount of total fuel readily available for burning. No quantitative measure of the exact amount of fuel increase is now available. However, a graphic presentation similar to figure 2, showing that the small fuels are drier than average and by how much, indicates that the larger fuels are also relatively drier. This concept is often overlooked.

### PROCEDURES FOR CALCULATIONS

For those who desire to make their own comparisons to a computed average on a 5-day seasonal or other periodic basis, the following explanation covers the necessary procedures.

Average 5-day cumulated fuel moisture percent.--To determine the long-term average, 5-day cumulated fuel moisture percents for identical periods must be computed for as many years as complete data are available. Measurements must begin on the same date of each year. (For this paper, June 1 was selected.) Ideally, the starting date should be early enough in the year to include the entire buildup period. Sufficient length of coverage should be allowed in order to avoid terminating ratings before any fire season is over. If a given year's set of data ends before the end of the fire season, it can be used; however, if a station does not begin recording cumulated moisture until after the predetermined common starting date, the data for that entire year cannot be used. Missing fuel moisture percents for 1 or 2 days can be estimated as outlined in regular observational procedures.

Figure 5. -- Monthly cumulated fuel moisture as a percentage of average for four fire-weather stations.

The following table illustrates the procedure for computing the average. It illustrates recording and computing procedure for only the month of June, but the procedure would be the same for all other months in a fire season. Notice that the 1959 data had to be discarded because observations did not start on the common date, June 1. The 1960 and 1962 data in the example could be used for the entire period. Data for the first 20 days of June 1961 can be used. As long as records of fuel moisture percents begin on the proper date and are continuous, they can be used even though they do not cover the entire fire season. Using even these incomplete data strengthens the earlier part of the season's average.

Determining average percents of 5-day cumulations of fuel moisture

June	Daily fuel moisture percents				5-day cumulated fuel moisture percents				Average 5-day cumulated fuel moisture percents
	1959	1960	1961	1962	1959 <sup>1</sup>	1960	1961	1962	
1	--	13	9	12					
2	--	11	10	14					
3	--	25	14	25					
4	--	25	21	12					
5	--	26	23	12	*	100	77	75	84
6	--	16	14	11					
7	--	13	12	10					
8	--	9	9	8					
9	--	14	9	10					
10	--	12	10	25	*	164	131	139	145
11	--	9	8	14					
12	--	10	10	21					
13	17	17	20	50					
14	19	24	17	33					
15	15	28	8	20	*	252	194	277	241
16	17	18	8	15					
17	13	11	8	12					
18	10	9	7	9					
19	9	8	6	10					
20	8	8	7	8	*	306	230	331	289
21	8	8	6	8					
22	7	8	6	7					
23	8	7	7	7					
24	6	6	--	7					
25	5	7	<sup>2</sup> --	7	*	342	--	367	<sup>3</sup> 355
26	7	7	--	7					
27	8	9	--	7					
28	7	8	--	7					
29	6	7	--	10					
30	7	7	--	11	*	380	--	409	<sup>3</sup> 395

<sup>1</sup> Data for 1959 could not be used because starting date was not common to other years in the series.

<sup>2</sup> Only June 1-20 can be used for 1961.

<sup>3</sup> The 5-day cumulated fuel moisture percent is averaged from only 2 years' data.

It must be remembered, however, that when computing the average one must divide by the number of years used. For example, in this table the average fuel moisture percents (last column) for the periods June 1-5, 6-10, 11-15, and 16-20 are computed from 3 years' data, but the averages for June 21-25 and 26-30 are based on only 2 years' data. In months that have 31 days, the last period is 6 days instead of 5.

This extra day does not upset calculations when it is used throughout the computations and is plotted in the same manner each time. The figures in the right-hand column are long-term averages and should be recomputed about every 5 years. Continuity of records is essential because any year that does not have complete records must be disregarded when computing the long-term averages.

Percent of average. --Once a long-term 5-day cumulated fuel moisture average has been established, comparison to any desired year is made by using the following formula:

$$\text{Percent of average} = \frac{\text{Current 5-day cumulated fuel moisture percent}}{\text{Average 5-day cumulated fuel moisture percent}} \times 100.$$

The percent of average must be computed for each successive 5-day period throughout the period of coverage (e.g., June 5, 10, 15; September 20, 25, 30). When this is completed, calculated values are plotted graphically on a convenient scale (as in fig. 2).

Comparison by period. --To arrive at a fuel moisture comparison for any given period, the procedure is similar to that for computing the cumulated percent of average shown above. First, using the average cumulated fuel moisture percents previously computed, find what the average cumulated fuel moisture is for the period of time desired. The following tabulation shows how to compute this average on a monthly basis.

<u>Date</u>	<u>Average 5-day cumulated fuel moisture (Percent)</u>	<u>Calculation</u>	<u>Average cumulated fuel moisture by month (Percent)</u>
June 30	395		395
July 31	607	607-395	= 212
Aug. 31	872	872-607	= 265
Sept. 30	1,350	1,350-872	= 478

The procedure is the same for computing the current period's cumulated fuel moisture percent. To arrive at a percent-of-average figure for comparison, the following formula is used:

$$\text{Percent of average (by period)} = \frac{\text{Cumulated fuel moisture percent of current period}}{\text{Cumulated fuel moisture percent of average period}} \times 100.$$

This information can then be represented graphically as desired. Figure 5 shows one method of presentation, but other methods are equally suitable.





# Research Note

UNITED STATES DEPARTMENT OF AGRICULTURE  
FOREST SERVICE

INTERMOUNTAIN FOREST & RANGE EXPERIMENT STATION  
OGDEN UTAH

U.S. Forest Service  
Research Note INT-14

1964

## DWARFMISTLETOE SURVEY IN WESTERN MONTANA

Donald P. Graham <sup>1</sup>

### ABSTRACT

The distribution and frequency of infection by dwarfmistletoes in a portion of western Montana was determined by a survey of 2,090 sample plots in the Clark Fork Unit, which includes some 3,400,000 acres of commercial timberland. Dwarfmistletoes were present in 23 percent of the plots. Ten percent of the 22,863 trees on all plots were infected, but 38 percent of the trees on the 474 infected plots had dwarfmistletoes. Data on frequency of infection are compiled and classified by county, timber type, and tree-size class.

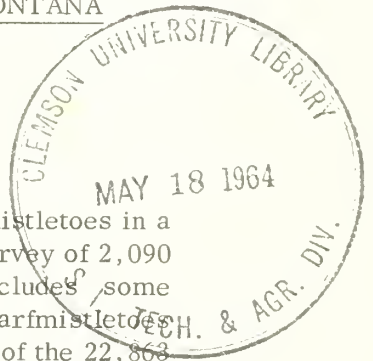

### INTRODUCTION

Dwarfmistletoes (*Arceuthobium* spp.) are recognized as one of the worst enemies of coniferous tree species and are widely distributed in western North America. They can drastically reduce both the growth potential and yield of timber stands. The distribution and severity of infection must be known before the full effect of dwarfmistletoes on growth and yield can be determined. As the harvesting of timber has increased during recent years, the need for quantitative information about dwarfmistletoes has also increased.

To meet this need, a portion of western Montana called the Clark Fork Unit was surveyed in 1958. The Clark Fork area includes most of the Clark Fork River drainage between the Continental Divide and the Montana-Idaho line (fig. 1). This dwarfmistletoe survey was made in cooperation with the Division of Forest Economics Research of the Intermountain Forest and Range Experiment Station and Region 1 of the Forest Service as part of an economic study to evaluate the timber management needs and industrial potential of the Clark Fork River drainage.<sup>2</sup>

<sup>1</sup> Now with the Division of Timber Management, Region 6, U.S. Forest Service, Portland, Oregon.

<sup>2</sup> Hutchison, S. Blair, and Arthur L. Roe. Management for commercial timber--Clark Fork Unit, Montana. Intermountain Forest and Range Expt. Sta. Res. Paper 65, 32 pp., illus. 1962.

## SURVEY METHOD

The general survey plan required an extensive sample of individual townships. Each township in the commercial forest zone was assigned a number. All townships that were inaccessible or that contained less than 50 percent commercial forest land were eliminated from the survey. Two hundred and nine townships, about 80 percent of those remaining, were then selected on a random scheme for the survey.

Each township was sampled at 10 locations, which were spaced at 10-chain intervals along a line. The start of each survey line was predetermined on maps from a point on the road nearest to the center of the township. The cardinal compass direction--north, south, east, or west--from this point to the township center was chosen as the bearing of the line.

At each of the 2,090 plots, we recorded detailed information from three concentric circular areas: a 1/5-acre area for sawtimber trees, a 1/50-acre area for pole-sized trees, and a 1/500-acre area for saplings. Trees were tallied on each plot by species, size class, and severity of dwarfmistletoe infection. Three tree-size classes and five classes of dwarfmistletoe



Figure 1.--Clark Fork Unit of western Montana, with county boundaries.

infection severity were used (see Appendix). In addition to the tree tally, the timber type within the sample plot boundary was determined.

## RESULTS

On the 2,090 plots, we recorded data from 22,863 trees, of which 48 percent were mature, 31 percent were pole-sized, and 21 percent saplings. Sixty percent of the plots were located in sawtimber, 35 percent in pole, and 5 percent in sapling stands. All plots were classified according to timber type so that results of this survey could complement forest inventory data compiled for the whole Clark Fork Unit. Forty-one percent of the plots were classified as Douglas-fir timber type, 10 percent as larch, 28 percent as lodgepole pine, and 21 percent as other timber types.

### EXTENT AND ABUNDANCE OF DWARFMISTLETOES

Dwarf-mistletoes were common on Douglas-fir (*Pseudotsuga menziesii*), western larch (*Larix occidentalis*), and lodgepole pine (*Pinus contorta*). Douglas-fir dwarf-mistletoe (*Arceuthobium douglasii*) was found only in the western part of the Clark Fork Unit, mostly west of the Mission and Sapphire mountain ranges. Infection in western larch and lodgepole pine trees was

found wherever these host species occurred except in a few local areas. Most of the larch dwarfmistletoe (*A. campylopodum* forma *laricis*) was in the extreme western part of the Unit, but most of the lodgepole pine dwarfmistletoe (*A. americanum*) was in the eastern part, where lodgepole pine stands are extensive. The other tree species, including ponderosa pine (*Pinus ponderosa*), were free of infection except for an occasional single tree or groups of several trees. Infected trees of these other species were found in heavily infected stands of Douglas-fir, western larch, or lodgepole pine. The dwarfmistletoes that infect trees in the Clark Fork area were previously described by Kimmey and Graham.<sup>3</sup>

Nearly one-fourth of the 2,090 plots had some infection. It was most prevalent in Missoula County, where 27 percent of the plots had infected trees, and was least prevalent in Mineral County, where only 15 percent of the plots contained infection (table 1). Dwarfmistletoes were found in 36 percent of the 208 plots in the larch timber type. Corresponding values in the Douglas-fir and lodgepole pine types were 25 percent of 858 plots and 21 percent of 576 plots, respectively. Fourteen percent of the plots in other timber types had infected trees, but the infection was usually light.

Table 1. --Number of plots examined and percentage of plots infected, by county and timber type

County	Timber type									
	Douglas-fir		Western larch		Lodgepole pine		Other		All types	
	Number	Percent	Number	Percent	Number	Percent	Number	Percent	Number	Percent
Deerlodge-Silverbow <sup>1</sup>	24	12	0	<sup>2</sup> --	60	18	6	17	90	17
Lewis & Clark-Powell <sup>1</sup>	128	11	11	27	106	28	35	14	280	19
Granite	78	10	0	--	125	29	22	9	225	20
Lake	24	0	37	32	4	25	25	16	90	19
Mineral	87	18	18	44	61	5	44	11	210	15
Missoula	227	33	67	31	82	23	104	12	480	27
Ravalli	135	36	0	--	44	34	106	8	285	25
Sanders	155	32	75	43	94	6	106	22	430	26
All counties	858	25	208	36	576	21	448	14	2,090	23

<sup>1</sup> Because of similar forest and dwarfmistletoe conditions, results from these counties were combined.

<sup>2</sup> Timber type was not represented on plots in this county.

### FREQUENCY OF INFECTION BY DWARFMISTLETOES

Data collected from individual trees on the plots furnished a detailed appraisal of frequency of dwarfmistletoe infection. Ten percent of all 22,863 trees on the 2,090 plots had infection (table 2). By comparison, dwarfmistletoes were present on 38 percent of 5,903 trees in the 474 infected plots (table 3).

<sup>3</sup> Kimmey, James W., and Donald P. Graham. Dwarfmistletoes of the Intermountain and Northern Rocky Mountain Regions and suggestions for control. Intermountain Forest and Range Expt. Sta. Res. Paper 60, 19 pp., illus. 1960.

Table 2. - Percentage of trees infected on all plots by county, timber type, and severity of infection

County and timber type	Total trees	Severity			Total
		Light to moderate	Heavy to very heavy	Percent	
<u>Deerlodge-Silverbow</u>					
Douglas-fir	178	0	1		1
Lodgepole pine	536	13	7		20
Other types	39	0	0		0
All types	753	<sup>1</sup> 10	5		15
<u>Lewis &amp; Clark-Powell</u>					
Douglas-fir	1,605	<sup>2</sup> T	1		1
Western larch	130	5	5		10
Lodgepole pine	1,246	11	7		18
Other types	443	T	2		2
All types	3,424	5	3		8
<u>Granite</u>					
Douglas-fir	1,064	1	T		1
Lodgepole pine	1,520	10	8		18
Other types	309	1	0		1
All types	2,893	5	5		10
<u>Lake</u>					
Douglas-fir	332	0	0		0
Western larch	513	7	1		8
Lodgepole pine	36	8	6		14
Other types	348	2	1		3
All types	1,229	4	1		5
<u>Mineral</u>					
Douglas-fir	877	3	4		7
Western larch	224	2	9		11
Lodgepole pine	555	1	T		1
Other types	443	1	1		2
All types	2,099	2	3		5
<u>Missoula</u>					
Douglas-fir	2,566	7	9		16
Western larch	906	7	6		13
Lodgepole pine	864	5	3		8
Other types	920	3	2		5
All types	5,256	6	6		12
<u>Ravalli</u>					
Douglas-fir	1,297	9	9		18
Lodgepole pine	378	7	10		17
Other types	689	1	1		2
All types	2,364	6	7		13
<u>Sanders</u>					
Douglas-fir	1,711	6	5		11
Western larch	893	10	7		17
Lodgepole pine	896	2	2		4
Other types	1,345	3	2		5
All types	4,845	5	4		9
<u>All counties</u>					
Douglas-fir	9,630	5	5		10
Western larch	2,671	8	5		13
Lodgepole pine	6,031	8	5		13
Other types	4,531	2	2		4
All types	22,863	5	5		10

<sup>1</sup> Percentages for "All types" are weighted averages. <sup>2</sup> "T" means less than one-half of 1 percent.

Table 3. --Numbers of plots infected, total trees on plots, and percent of trees infected, by timber type

Timber type	Infected plots	Total trees	Percent infected
Douglas-fir	216	2,361	39
Western larch	76	1,150	30
Lodgepole pine	121	1,545	51
Other types	61	847	20
All timber types	474	5,903	<sup>1</sup> 38

<sup>1</sup> Weighted average.

The number of trees infected was low in all counties--from only 5 percent in Lake and Mineral Counties to 15 percent in the Deerlodge-Silverbow area (table 2). Infection was found in 11 percent of the sawtimber trees, 9 percent of the pole-sized trees, and 7 percent of the saplings (table 4).

Table 4. --Percentage of trees infected on all plots, by timber type and tree-size class

Timber type and tree-size class	Total trees	Percent infected
<u>Douglas-fir</u>		
Sawtimber	5,666	11
Pole	2,276	8
Sapling	1,688	8
	<u>9,630</u>	
<u>Western larch</u>		
Sawtimber	1,282	19
Pole	657	12
Sapling	732	3
	<u>2,671</u>	
<u>Lodgepole pine</u>		
Sawtimber	1,498	18
Pole	2,974	12
Sapling	1,559	11
	<u>6,031</u>	
<u>Other timber types</u>		
Sawtimber	2,553	4
Pole	1,144	3
Sapling	834	3
	<u>4,531</u>	
<u>All timber types</u>		
Sawtimber	10,999	11
Pole	7,051	9
Sapling	4,813	7
	<u>22,863</u>	

Infected trees accounted for 13 percent of all trees in the larch and lodgepole pine types, respectively (table 2), but 30 percent of the trees in infected larch plots and 51 percent of the trees in infected lodgepole pine plots had dwarfmistletoes (table 3). Ten percent of all trees in the Douglas-fir type had infection, but dwarfmistletoes were found in 39 percent of the trees in infected plots in this type.

## DISCUSSION

This survey showed that dwarfmistletoes pose a problem in management of only three tree species in the Clark Fork drainage of western Montana. But the parasites are not uniformly distributed throughout the drainage. This lack of uniform distribution should serve as a warning to forest managers. Whenever forest inventories are made for management purposes, distribution of dwarfmistletoes should be carefully mapped by host species, intensity of infection, and stand characteristics.

Douglas-fir dwarfmistletoe was most abundant in Ravalli and Missoula Counties, larch dwarfmistletoe in Mineral and Sanders Counties, and lodgepole pine dwarfmistletoe in Deerlodge, Silverbow, Lewis and Clark, and Powell Counties. Dwarfmistletoes were most frequent in the larch timber type, intermediate in the Douglas-fir and lodgepole pine types, and lowest in other timber types. In the Douglas-fir, larch, and lodgepole pine timber types, the species that determined the type usually was most frequently and severely infected.

The lower frequency and lighter intensity of infection in timber types other than Douglas-fir, larch, or lodgepole pine had been expected and was confirmed (table 1). The primary host species (Douglas-fir, larch, and lodgepole pine) were often scattered through the other timber types, but were a minor component of them. Most of the infection in these types is attributed to presence of infected Douglas-fir trees in the ponderosa pine type, infected lodgepole pine trees in the Engelmann spruce and subalpine fir types, and infected larch trees in the grand fir, western hemlock, western redcedar, and western white pine types.

The lowest frequency and lowest intensity of dwarfmistletoes were found in the sapling class. Small trees expose less target area for reception of seeds than large trees and are often screened from sources of infection by intervening trees. Also, small trees are usually rather young and consequently have been exposed to infection for less time than large trees.

Since the survey was extensive but not designed to determine growth impact losses, the results can be assessed only in general terms for large areas. For purposes of starting control projects, more intensive surveys will be required. However, general knowledge about impact on growth, spread, and intensification of dwarfmistletoes suggests that stands in the Clark Fork Unit have more infection than can be tolerated if future needs for timber products are to be filled.

## APPENDIX

### EXPLANATION OF TERMS USED WITH RECORDED DATA

#### Tree-size class:

- Sawtimber = trees 11.0 inches d.b.h. or larger
- Poletimber = trees 5.0 to 10.9 inches d.b.h.
- Saplings = trees 2.0 feet high to 4.9 inches d.b.h.

#### Dwarfmistletoe severity:

Severity of infection in each tree was determined by dividing live crown into two equal parts. Each half was rated as:

- 0 = no infection
- 1 = less than one-third of the branches infected
- 2 = more than one-third of the branches infected

These numbers were added to give an overall rating for the tree:

- 0 = dwarfmistletoe free
- 1 = lightly infected
- 2 = moderately infected
- 3 = heavily infected
- 4 = very heavily infected

#### Timber type:

Based on the tree species predominant on the plot using cubic-foot volume of sawtimber-sized trees on plots classified as sawtimber, cubic-foot volume of pole-sized trees on plots classified as poletimber, and number of stems on plots classified as saplings.







# Research Note

UNITED STATES DEPARTMENT OF AGRICULTURE  
FOREST SERVICE

**INTERMOUNTAIN FOREST & RANGE EXPERIMENT STATION**  
OGDEN UTAH

U.S. Forest Service  
Research Note INT-15 (rev.)

1964

## WHAT DO YOU MEAN, "SITE PREPARATION"?

James D. Curtis, Research Forester  
Division of Forest Disease and Timber Management Research

### ABSTRACT

Successful regeneration of many forest tree species requires planned treatment of the site, commonly called "site preparation." Such treatment can be accomplished by mechanical means, by use of chemicals, or by burning. The amount and kind of site treatment needed depend on local conditions, silvical requirements, and costs. Because there are many ways in which a forest area can be treated and because the forester must strive to prevent loss of soil from the site, an understanding of site preparation terms is important. An attempt is made to set forth and describe the methods frequently used by foresters in the course of preparing ground for regeneration.

Site preparation is brought about by reducing or eliminating unwanted vegetation, by disturbing the soil to loosen it, or by rearranging it. Site preparation is now employed in some regions and types of ownership, especially where soil moisture in the growing season reaches critically low levels. It probably will be practiced even more generally in the years ahead. Because site preparation involves such an important and indispensable medium, it would appear appropriate to designate, with explanation, the operations which produce this soil rearrangement. Definitions of site preparation terms are now either unavailable or vague. They would be useful for those engaged in either research or operational aspects of forest site preparation for purposes of clarity in common understanding.

The intensiveness of silvicultural practice has probably progressed more in the last 10 years than it did in the previous 50. Many factors are responsible but there is no gainsaying the fact that sustained yield, as applied to forest crops, has become more

than an obscure goal, a hackneyed textbook phrase, or a magic term bandied about enthusiastically in the secluded atmosphere of professional meetings. One of the facets of silviculture that has been appreciated and practiced during this same period is the indispensable role of forest regeneration. Problems of tree regeneration always have claimed and always will claim the attention and exertions of silviculturists; yet, often this logical and sometimes difficult task of mature crop replacement was left to hope. Hoping was not enough.

Some degree of site preparation is usually needed to start a new crop of most forest tree species, especially conifers; this is an integral and important part of silviculture (8). Site preparation should achieve two main objectives: exposure of mineral soil in desirable amount with acceptable distribution, and reduction or elimination of live competition. Mineral soil is the most suitable growing medium for tree seedlings because of its abundance, its moisture-holding capacity, and the ease with which roots can penetrate it. Where site preparation loosens the soil, water percolation rate may be increased and the opportunity for initial seedlings root penetration enhanced. It should be noted that making mineral soil available and eliminating vegetative competition do not, per se, guarantee natural regeneration.

In regions where summer rainfall is usually ample, as in New England, tree seedlings can establish themselves in competition with other vegetation; nevertheless, they would grow better if they had no competition. When moisture becomes critical during the growing season, as it does in some of the forest regions that support high volumes per acre, it may become necessary within the bounds of reasonable cost to eliminate all competing vegetation. This operation requires much soil cultivation, or at least that the soil be laid bare. Subsequently, on level ground, soil erosion is no great problem because it results chiefly from wind action; but on sloping ground soil movement may be serious because of overland flow of surface water.

A large area of forest ground is treated each year, perhaps 1,000,000 acres;<sup>1</sup> this area is increasing annually. Any manipulation of the forester's basic asset, forest soil, requires knowledge and skill if it is to serve its purpose. Furthermore, land that supports a specific type of growth for a long period of time reaches a degree of ecological balance. When site preparation is carried out, this balance is suddenly and drastically disturbed. Unless the silviculturist is aware of the possible results of his planned disturbance, he can bring about a vegetational change that may be as severe (i. e., as competitive) as the very one he is attempting to eliminate. This disturbance can also start or increase erosion. Thus, timing and degree of site disturbance are linked and of great importance.

---

<sup>1</sup>No precise figures on area of site preparation are available. Meyer (13) cites 200,000 acres as a conservative estimate of annual area of site treatment by 21 industrial organizations in the Southeast.

The disturbance of the forest floor caused by logging may be insufficient in amount or in location to result in seedling establishment, and there is often slash to hinder germination, seedling growth, and accessibility. Planned site preparation is invariably needed.

Forest site preparation is accomplished by mechanical means, by use of fire, and by chemical treatment, or by a combination of two or all three. These three methods of site preparation have been greatly developed and even refined in recent years.

Heretofore, hand scalping, disking, and plowing have been the common ways of preparing ground for natural regeneration or for seeding and planting. These methods resulted in partial elimination of competition and limited exposure of mineral soil. Forest land from which mature timber has been removed or land that is to be reclaimed is now treated more efficiently and economically by tractors of all sizes with various attachments, some of which are specially designed for site preparation. The amount of mineral soil exposed in these operations varies from perhaps 20 to as much as 100 percent, depending on the terrain, the cover, and the requirements of the tree species being established. At present, use of machinery is confined to slopes less than 35 percent whereon the ground or the vegetation on it can be disked, furrowed, stripped, ripped, punched, slitted, dragged, chopped, tilled, churned, hogged, or crushed (5, 10, 1, 15, 9, 2, 14, 19, 20, 3, 12, 11).

Animal power, though limited in scope, is used occasionally. Also, the planned and unplanned herding of different domestic animals has resulted in ground preparation, with varying degrees of success. This latter type of site preparation is difficult to control.

Fire has been used for many years in silvicultural work on a technically planned basis to rid areas of logging slash and of accumulated litter. The various methods of slash disposal and use of fire adapted to specific silvicultural needs are well known and are described adequately elsewhere (7, 16). Successful use of fire as a means of site preparation requires unusual skill and a generous measure of luck. If carried off as planned it can be economically worthwhile in ridding areas of debris and exposing mineral soil; but fire can also be ineffective when overcaution is exercised and occasionally becomes destructive and expensive when calculated risks are taken, as they must be. Nevertheless, fire is, and probably will remain, a cheap and a satisfactory means of site preparation, especially in coniferous forests where slash disposal and hazard abatement are required.

During the last decade tremendous strides have been made in the use of chemicals to dispose of unwanted vegetation. The well-known formulations of 2,4,5-T and 2,4-D have been and are being widely used in all parts of the continent (4). They are applied commonly by ground-pumping units (18), but they are also applied by aircraft at reasonable cost and with satisfactory results. It is sometimes necessary to spray the same area more than once to achieve a complete kill of the vegetation (6). After the undesirable vegetation is killed by phytocides it is commonly burned (17). Sometimes

it can be windrowed by machine or perhaps crushed to facilitate and make safer its subsequent disposal by burning and the mechanical treatment of the soil (17). Shallow-soiled sites where mechanical treatment would be too harsh can be more safely and satisfactorily treated by chemicals to reduce or eliminate competition; such areas should not be clear cut. On such sites, spraying by use of ground-based machines has proved feasible (18).

All treatments of site have a common objective: to bring about germination of sufficient seed per acre and/or survival and acceptable growth of enough of these or planted seedlings per acre to form a new stand of desired species. The achievement of this objective depends on the usual requirements for plant growth and also on the amount of seed, numbers of predators, and the competition from weed seeds and sprouts on the site during the first and subsequent growing seasons. The time when sites are prepared will depend on the soil, the climate, and the silvical requirements of the tree species being established. In the West, the summer or fall prior to the year of stand establishment is preferable for site preparation because most of the soil settling occurs before the following spring. Seed that has fallen on freshly and uniformly scarified ground is covered with soil by the action of rain, gravity, and wind. For most tree species, seed that is covered by soil is more likely to germinate and grow than if it remained on the soil surface.

Forest site preparation can be defined as the treatment of soil and ground cover or slash on it, by hand, machinery, applied chemicals, or fire, or a combination of them, to prepare the soil surface for favorable reception to either naturally disseminated or artificially sown seed, or to planted seedlings.

Site preparation can take many forms and can be achieved in many ways. The entire site, or only parts of it, can be treated. The following site treatments are believed to be those most likely to be used now and in the foreseeable future to prepare ground primarily for the regeneration of forests.

- A. COMPLETE SITE PREPARATION. The entire area is treated preparatory to regeneration by either artificial or natural means.
  1. Machinery. The site may or may not be scarified (16), but the entire area (except ground occupied by stumps, large boulders, and collected debris) is scalped. Scarification can be done on level ground and on slopes up to 35 percent with a variety of equipment. On sloping ground, areas are worked from the uphill side and along the contours to keep later soil movement to the minimum. Usually, all vegetation and debris are removed and pushed to the perimeter of the area or into windrows or into ravines.
  2. Fire. Usually fire is employed to dispose of (a) logging slash and (b) vegetation already killed by either mechanical or chemical means. This amounts to controlled burning over the entire area.
  3. Chemicals. Phytocides are used to eliminate or to reduce greatly the vegetative competition on the area. Initial treatment may be followed by an additional application of chemicals, use of fire, or mechanical treatment.

B. PARTIAL SITE PREPARATION. Only a part of the area to be regenerated is treated. Usually, but not always (or entirely), treatment is for the purpose of promoting artificial regeneration.

1. Machinery

- a. Scarification. Commonly done by rakes, rippers, or discs. Most of the area is scarified, but not all live vegetation is removed. It is a purely mechanical operation over the entire area, and some vegetation escapes the scarifying device. Scarifying can be done in the process of machine piling and burning of logging slash. Sloping ground should be scarified along contours.
- b. Strips, furrows, trenches. Plows throw the turned soil to one side; trenchers throw it to both sides. Commonly done by dozer blades, front- or rear-mounted plows and discs, or trenchers on tractors working along contours. Stripping removes the top layer of soil together with the seeds in it and the plants on it. There is less competition immediately following stripping than after furrowing or trenching. The deeper the stripping, the more enduring the effect.

The precise arrangement of the treated parts of the site will vary; some parts are left untreated because they are either not needed for acceptable stocking of forest trees or, on steep ground and erosible soil, they serve as barriers to movement of water and soil. In preparing sites above stream bottoms, untreated ground should always be left as a buffer to soil movement.

For greatest usefulness, furrows should be made along the contours to minimize horizontal and downhill movement of water. On sloping ground, contour furrows<sup>2</sup> are made, and for machine planting the furrow slice (side cast) is thrown downhill so that the planting unit will ride level. This lessens the competition against the sown seed or planted seedling and guides moisture to the tree's roots.

- c. Terraces. Contour terraces,<sup>3</sup> commonly the width of the tractor that is doing the work, are constructed along contours where it is

---

<sup>2</sup>See "Furrows" and "Terraces" (16, pp. 35, 87). Both contour furrows and contour terraces are defined as being constructed to check runoff and soil loss. Their purpose as described here is to provide a stable structure in which to grow trees, an entirely different function. Actually furrows and terraces can be dual-purpose structures.

<sup>3</sup>Ibid., p. 87.

desirable to reforest steep (35 percent and over) sidehills. Seeding or planting is done directly on the newly created surface. Terraces slope slightly inward to hold moisture and keep soil movement to the minimum. They are expensive and hazardous to construct and require unusually skilled operators.

2. Fire. Fire is used to dispose of slash or live or dead vegetation over part of the area either because it is a fire hazard or because it interferes with the establishment of reproduction.
3. Chemicals. Phytocides are applied only to that part of the area where reproduction is intended or to certain plants that are to be eradicated from the area.
4. Manual labor. Part of the site is prepared by individually made scalps (16, p. 35) and pits. For scalps, live and dead vegetation is removed from a small (usually about 30 by 30 inches) spot to facilitate the sowing of seed or planting of a seedling and to reduce or eliminate vegetative competition with the seedling; for pits, shallow depressions or basins are made, in which planting is done manually.

A pit is free of debris and vegetation; in its deepest part, moisture is guided towards the planted tree. On steep ground these pits are made level to avoid soil washing and also to prevent water from moving soil away from the planted tree. Soil directly uphill from the pit must necessarily be removed to prevent its sloughing, filling the pit, and burying the tree. This soil removal should leave a convex rather than a concave surface directly above the tree; otherwise water and soil from heavy storms will collect and channel into the pit.

## LITERATURE CITED

1. Anonymous.  
1955. Forest and water research project. Dept. Forests and Water, Commonwealth of Pennsylvania, Harrisburg. Report 3, 44 pp., illus.
2. Buck, J. M.  
1959. Site preparation for forest regeneration in California. U.S. Forest Serv. Calif. Region, 26 pp., illus.
3. Crossley, D. I.  
1952. White spruce reproduction resulting from various methods of forest soil scarification. Canada Dept. Resources and Development, Silviculture Res. Note 102, 18 pp., illus.
4. Dahms, Walter G., and George A. James.  
1955. Brush control on forest lands. U.S. Forest Serv. Pacific Northwest Forest and Range Expt. Sta. Res. Paper 13, 81 pp., illus.
5. Gordon, Donald T.  
1956. Slash disposal and seedbed preparation by tractor. Jour. Forestry 54: 771-773.
6. Gratkowski, H.  
1959. Effects of herbicides on some important brush species in southwest Oregon. U.S. Forest Serv. Pacific Northwest Forest and Range Expt. Sta. Res. Paper 31, 33 pp., illus.
7. Hawley, Ralph C.  
1937. Forest protection. 262 pp. New York: John Wiley and Sons.
8. \_\_\_\_\_, and David M. Smith.  
1954. The practice of silviculture. Ed. 6, 525 pp., illus. New York: John Wiley and Sons.
9. Holt, L., H. S. D. Swan, and G. F. Weetman.  
1956. Forest soil scarification. Pulp and Paper Res. Institute of Canada, 49 pp., illus.
10. Little, S., C. B. Cranmer, and H. A. Somes.  
1958. Direct seeding of pitch pine in southern New Jersey. U.S. Forest Serv. Northeastern Forest Expt. Sta. Station Paper 111, 14 pp., illus.

11. Little, S., and J. J. Mohr.  
1954. Reproducing pine stands on the eastern shore of Maryland. U.S. Forest Serv. Northeastern Forest Expt. Sta. Station Paper 67, 11 pp.
12. Merz, Robert W., and Raymond F. Finn.  
1955. Yellow-poplar responds to preplanting ground treatment. U.S. Forest Serv. Central States Forest Expt. Sta. Tech. Paper 150, 18 pp., illus.
13. Meyer, Walter H.  
1960. Impressions of industrial forestry in southeastern United States. Jour. Forestry 58: 179-187.
14. Rudolf, Paul O.  
1950. Forest plantations in the Lake States. U.S. Dept. Agr. Tech. Bull. 1010, 171 pp., illus.
15. Scheer, R. L., and F. W. Woods.  
1959. Intensity of preplanting site preparation required for Florida's sandhills. U.S. Forest Serv. Southern Forest Expt. Sta. Occas. Paper 168, 12 pp., illus.
16. Society of American Foresters.  
1958. Forestry terminology, a glossary of technical terms used in forestry. 3d ed. rev., 97 pp. Washington: Society of Amer. Foresters.
17. U.S. Forest Service.  
1957. Annual report. Calif. Forest and Range Expt. Sta. 82 pp., illus.
18. \_\_\_\_\_.  
1959. Annual report. Pacific Northwest Forest and Range Expt. Sta. 90 pp., illus.
19. Wenger, Karl F., and Kenneth B. Trousdell.  
1957. Natural regeneration of loblolly pine. U.S. Dept. Agr. Prod. Res. Rpt. 13, 78 pp., illus.
20. Woods, Frank W., John T. Cassady, and Harry Rossoll.  
1958. How to prepare Gulfcoast sandhills for planting pines. U.S. Forest Serv. Southern Forest Expt. Sta. Occas. Paper 161, 11 pp., illus.





# Research Note

UNITED STATES DEPARTMENT OF AGRICULTURE  
FOREST SERVICE

**INTERMOUNTAIN FOREST & RANGE EXPERIMENT STATION**  
OGDEN

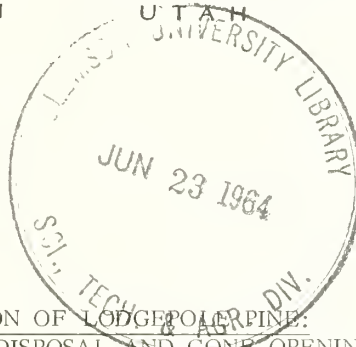

1964

U.S. Forest Service  
Research Note INT-16

REGENERATION OF LODGEPOLE PINE:  
A STUDY OF SLASH DISPOSAL AND CONE OPENING<sup>1</sup>

James E. Lotan, Research Forester  
Division of Forest Disease and Timber Management Research

ABSTRACT

In central Montana, two to three times as many lodgepole pine seedlings per acre were established when logging slash was piled green than when it was piled after drying for a summer. On the Lewis and Clark National Forest 22,175 seedlings per acre were established when slash was piled fresh and 10,475 when it was piled dry; the treatments yielded 7,067 and 1,967 seedlings, respectively, on the Gallatin National Forest.

Serotinous cones placed 1 foot or more above the ground did not open, whereas 40 and 83 percent of the cones placed directly on the ground opened on north and south slopes, respectively.

Studies<sup>2</sup> have shown that methods used to regenerate lodgepole pine (*Pinus contorta* Dougl.) in central Montana produce a superabundance of seedlings. As a result, noncommercial thinnings are needed to prevent the newly regenerated stands from becoming stagnated. Current regeneration practices rely primarily upon the presence of seed stored in serotinous cones in the slash following logging operations. This slash remains in place during one growing season before disposal, and thus permits cones to dry, open, and release the stored seed. Refined methods of slash disposal are needed that will provide optimum density and maintain adequate stocking.

<sup>1</sup> Research reported in this paper was done at the Forestry Sciences Laboratory at Bozeman, Montana, maintained in cooperation with Montana State College.

<sup>2</sup> Boe, K. N. Regeneration and slash disposal in lodgepole pine clear cuttings. Northwest Sci. 30: 1-11, illus. 1956. The present study was installed by Mr. Boe, formerly forester with Intermountain Forest and Range Experiment Station, now with Pacific Southwest Forest and Range Experiment Station.

Our hypothesis was that if the slash were piled while still green, immediately after logging, fewer cones would open, fewer seed would be released, and the potential for overstocking would therefore be lessened. This report compares density and stocking of lodgepole pine seedlings in clear-cut areas where slash was piled while green, with density and stocking in areas where slash was piled after drying for one summer. The relation of height above ground and aspect (north and south) to cone opening and release of seed is also reported.

## METHODS

We tested two methods of slash disposal using a randomized block design on the Langhor drainage (elevation 7,000 feet) of the Gallatin National Forest and the Deadhorse drainage (elevation 6,500 feet) of the Lewis and Clark National Forest. The treatments consisted of: (1) piling green slash before it had been subjected to summer temperatures and (2) piling slash that had dried for one summer. The slash was burned in the fall in each treatment. Using the stocked-quadrat method we counted seedlings on milacre plots after the first, second, third, and seventh growing seasons.

In another phase of this study, branches bearing serotinous cones of three age classes (1 to 2, 3 to 9, and 10+ years old) were placed on the ground and at 1-, 2-, and 3-foot heights above the ground on north and on south aspects (fig. 1). In the two study areas six branches were placed at each height on both aspects; seed released from cones were caught in small wire screen baskets. To determine the effect of wire baskets on cone opening, 12 cones were placed 6 inches above square-foot seed traps on each study area--six cones in screen baskets and six without screens.

## RESULTS

### SLASH DISPOSAL METHODS AND SEEDLING ESTABLISHMENT

Contrary to expectations, two to three times as many seedlings per acre were established when logging slash was piled green as when it was piled after drying for a summer (table 1). On the Lewis and Clark National Forest the difference between treatments expressed in numbers of seedlings was significant at the 95-percent level of probability; the difference on the Gallatin National Forest was significant at the 93-percent level.

Table 1.--Density, stocking, and height of lodgepole pine seedlings  
7 years after slash treatments

Slash condition	: Langhor Creek, Gallatin N.F.			: Deadhorse Creek, Lewis and Clark N.F.		
	: Seedlings :	: Stocking :	: Height at :	: Seedlings :	: Stocking :	: Height at :
	per acre	Percent	age 7	per acre	Percent	age 7
	<u>Number</u>	<u>Percent</u>	<u>Feet</u>	<u>Number</u>	<u>Percent</u>	<u>Feet</u>
Green	7,067	78.3	1.6	22,175	97.5	1.6
Dry	1,967	53.3	1.1	10,475	98.8	2.0

Analysis of stocking showed no significant difference between treatments. Nor was there significant difference between treatments in average height of the tallest seedling on each stocked quadrat at age 7.

Figure 1. - - Branches bearing serotinous cones placed on the ground and at 1-foot intervals above it.



3 ft.  
2 ft.  
1 ft.  
Ground level

### SEROTINOUS CONE OPENING

Only those cones placed directly on the ground opened. No cones opened that were 1 foot or more above the ground. Of cones on the ground, 83.3 percent on the south aspect released seed, compared with only 40.5 percent on the north aspect.

Although the same percentage (17 percent) of the caged and uncaged cones placed above seedtraps opened fully, the writer believes that the wire screen baskets may have had an undetermined inhibitory effect on cone opening for the following reasons:

1. Sampling was not adequate to determine a real effect of the wire screens.
2. Cone opening is directly related to temperatures needed to melt the resin bond between the cone scales and undoubtedly the wire screens shaded the cones inside.
3. The percentages of cones that opened on both aspects appeared to be low, although soil surface temperatures in the summer commonly exceed those necessary to break cone serotiny at these elevations.<sup>3</sup>

No significant differences were found among three age classes of cones (1 to 2, 3 to 9, and 10+ years old) in either number of seed released or percentage of sound seed. An average of  $12.3 \pm 3.0$  seed per cone (at 95-percent level of probability) was released, of which 50.3 percent of the seed were sound.

<sup>3</sup> Data filed at Intermountain Forest and Range Experiment Station, Bozeman, Montana.

In lodgepole pine, the number of fully developed seed per cone varies widely--from one or two to 50.<sup>4</sup> Apparently, in central Montana a low average number of sound seed per cone can result in the establishment of a superabundance of seedlings on clear cuts--probably because of the large number of serotinous cones and the favorable environment for germination.

## DISCUSSION

### SLASH DISPOSAL METHODS AND SEEDLING ESTABLISHMENT

We had anticipated that piling the slash green would result in fewer cones opening to release seed. But, apparently slash in both treatments remained in place long enough for the resin bonds to melt on cones that were close to the ground. Most cones begin to open when subjected to temperatures above 113° F.<sup>5 6</sup> The writer has observed cones on or near the ground beginning to open within 15 minutes after trees had been felled on a hot summer day.

Although not thoroughly tested, the following are possible explanations for anomalous results from piling slash:

1. Piling slash after it has dried for a summer destroys some seedlings that germinate from seed released either from nonserotinous cones prior to cutting or from serotinous cones that open early enough in the season to permit germination the same year. When this is done, machinery used in piling is on the area after these seedlings have germinated with the result that many are trampled. Piling slash green, however, distributes some cones on the ground without a covering of slash. Thus, exposed to high soil surface temperatures, they are more likely to open than are cones buried in dry slash. When the green slash method is used, most germination occurs the spring after piling and therefore seedlings are not subjected to destruction by machinery used in piling. The same is true for seedlings originating from nonserotinous cones.

2. It is probable that fewer seeds germinate during the first year in the dry slash treatment because scattered dry slash inhibits germination. Exposure of these seed to destructive agents (rodents, insects, fungi) for an additional year decreases the likelihood of germination the second year.

## CONCLUSIONS

### SLASH DISPOSAL

Neither method of slash disposal resulted in desirable seedling intensity. However, results of the dry slash treatment on Langhor Creek were nearly satisfactory. An abundant seed source in serotinous cones and favorable environmental conditions in central Montana combined to produce a superabundance of seedlings in both treatments. When this occurs, thinning is necessary to prevent stagnation and loss of growth.

### SEROTINOUS CONE OPENING

The cone opening phase of this study clearly demonstrated that for serotinous cones to open they must be on or near the ground, where soil surface temperatures in summer usually exceed those required to break serotiny. If weather conditions are right, only a few days are needed to break the resin bond on a large percentage of cones.

---

<sup>4</sup> Tackle, David. *Silvics of lodgepole pine*. U.S. Forest Serv. Intermountain Forest and Range Expt. Sta. Misc. Pub. 19, 24 pp., illus., rev. 1961.

<sup>5</sup> Clements, F. E. *The life history of lodgepole pine burn forests*. U.S. Forest Service Bull. 79, 56 pp., illus. 1910.

<sup>6</sup> Cameron, Hugh. *Melting point of the bonding material in lodgepole pine and jack pine cones*. Canada Dept. Resources and Devlpmt. Forestry Branch, Forest Res. Div., Silv. Lflt. 86, 3 pp. 1953.



# Research Note

UNITED STATES DEPARTMENT OF AGRICULTURE  
FOREST SERVICE

INTERMOUNTAIN FOREST & RANGE EXPERIMENT STATION  
OGDEN UTAH

U.S. Forest Service  
Research Note INT-17

1964

## REGENERATING LODGEPOLE PINE IN CENTRAL MONTANA FOLLOWING CLEAR CUTTING

David Tackle<sup>1</sup>  
Division of Forest Disease and Timber Management Research

### ABSTRACT

Reports a 10-year study in central Montana of stocking and density of regeneration on different kinds of seedbeds and on seed dispersal from standing timber. In each of 7 years, seed did not disseminate beyond 3 chains (about 200 feet) into clear cuttings in quantities sufficient for reproducing a stand. Usually about two-thirds of the total number of seeds released in a year fell during the period October to June.

After 10 years, no significant changes in density or stocking were apparent except on burned seedbeds, which were adequately stocked but not overstocked; other seedbeds were overstocked. Discusses new recommendations for slash disposal to meet different management objectives.

### INTRODUCTION

Careful treatment of cone-bearing logging slash is necessary to assure prompt and complete natural restocking of clear-cut blocks of lodgepole pine (*Pinus contorta* Dougl.) in central Montana. Boe reached this conclusion after evaluating results of a 5-year study on relations of seedling density and stocking to seedbed conditions.<sup>2</sup> He

<sup>1</sup> Research forester, Intermountain Forest and Range Experiment Station, Forest Service, U.S. Department of Agriculture; stationed at Forestry Sciences Laboratory, Bozeman, Montana, maintained in cooperation with Montana State College.

<sup>2</sup> Boe, Kenneth N. Regeneration and slash disposal in lodgepole pine clear cuttings. Northwest Sci. 30: 1-11, illus. 1956.

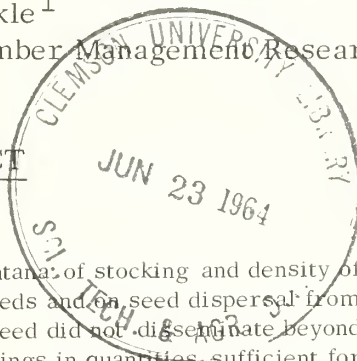

also analyzed patterns of seed dispersal from bordering uncut timber into a clear cutting and the adequacy of seed from this source for the regeneration of clear-cut blocks. Observations on his study plots were continued for a second 5-year period. This paper reports the status of regeneration in the study areas 10 years after their establishment.

## METHODS

A summary of experimental methods described by Boe is presented here for convenience.

The study was located in pure, even-aged, overmature stands on the Lewis and Clark National Forest at elevations of 6,500 to 7,100 feet. Slash treatments were carried out in the fall of 1949 on block clear cuttings of from 30 to 50 acres each made in the previous winter and spring. The randomized block design included four methods of slash disposal replicated six times. Three replications were on north-facing and three on south-facing slopes.

Slash treatments were:

1. Burning slash windrows and concentrations
2. Burning scattered slash piles made by bulldozer
3. Lopping and scattering slash, and
4. No treatment, as a check.

Logging and the slash treatments listed above created the following seven kinds of seedbeds which were named for their principal distinguishing characteristics:<sup>3</sup>

1. Burned, piled slash
2. Burned, slash windrows and concentrations
3. Slash, windrows and concentrations
4. Forest floor
5. Skidroads
6. Scarified, bulldozer
7. Slash, lopped and scattered.

Randomly located milacre plots sampled reproduction on each type of seedbed.

Seed dispersal was studied by placing  $\frac{1}{4}$ -milacre seedtraps at 1-chain intervals within the timber at either side of and across one clear cutting (Adams Creek). Seed was collected from the traps and examined at several intervals during each year. The first period of seedfall study was 1950-1953.<sup>4</sup>

---

<sup>3</sup> "Seedbed" as used in this paper means the mineral soil and any covering materials that were present.

<sup>4</sup> Boe, op. cit., p. 2.

Seed dispersal was observed for 2 more years on Adams Creek. In addition, data on seed dispersal were recorded from 1955 to 1957 on Wolsey Creek. Here the elevation was lower and the seedtraps were oriented on a north-south line in contrast to the east-west orientation on Adams Creek to see whether the dispersal pattern would be different.

RESULTS

SEED DISPERSAL

The first 3 seed years of record (1950 through 1952) showed that only small quantities of seed, insufficient for reproducing a stand, are dispersed beyond 3 chains from a timber edge. This pattern of dispersal was verified during 1953 and 1954 at Adams Creek as well as at Wolsey Creek in 1955 and 1956 (fig. 1).

Figure 1.--Dispersal of sound lodgepole pine seed into clear cuttings from adjacent mature timber during 4 seed years (Adams Creek, 1953 and 1954; Wolsey Creek, 1955 and 1956, Lewis and Clark National Forest, Montana).

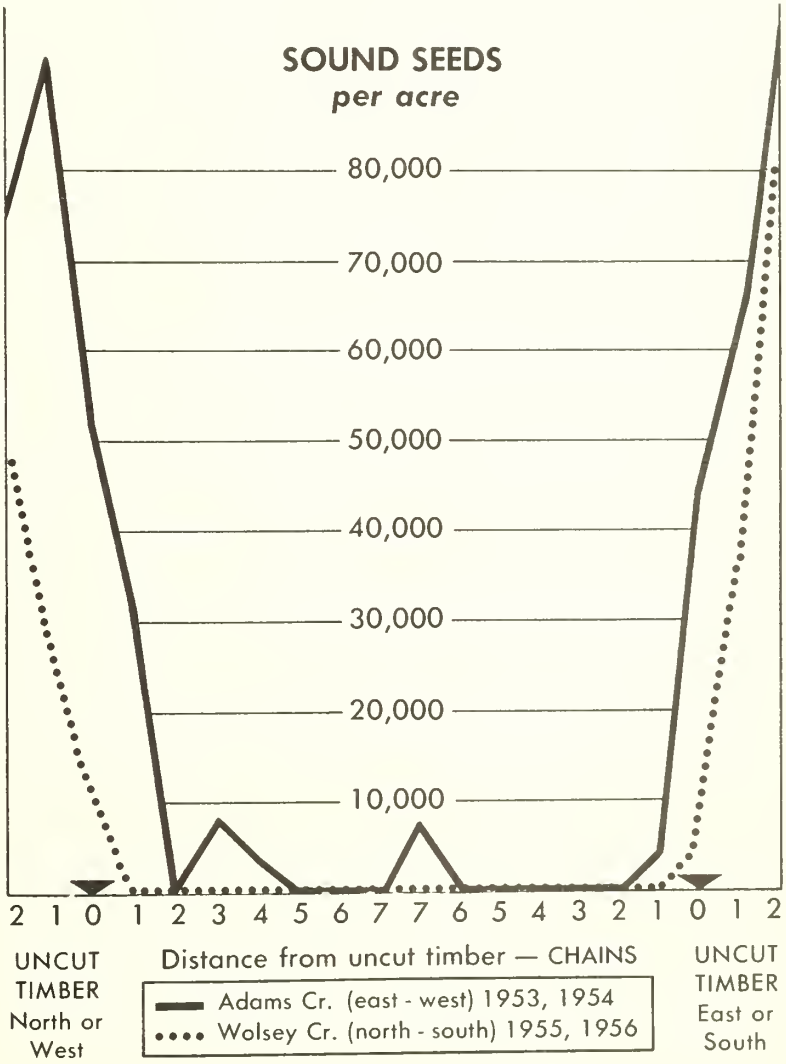

The annual distribution of seedfall during the first 3 years of study was also confirmed by further sampling. The pooled percentage dispersal throughout the year for both the Adams Creek and Wolsey Creek areas during 4 seed years (1953-1956) is compared with earlier findings (table 1). The combined dispersal percentages for the entire period of study were computed by weighting dispersal figures for each area by the number of years of observation of the area. The final percentages are based on observations for 7 seed years. Generally, about two-thirds of the annual seed crop that is released is dispersed during the period of October through May.

Table 1. -- Percentage of lodgepole pine seed released from uncut stands in central Montana by periods

Period of year	Adams Creek	Adams Creek and Wolsey Creek	
	1950-1952 <sup>1</sup>	1953-1956 <sup>1</sup>	1950-1956 <sup>1</sup>
----- Percent -----			
August-September	20	18	19
October-May	62	70	66
June-July	18	12	15

<sup>1</sup> Seed years.

Although most of the seed dispersed probably came from nonserotinous cones, Clements<sup>5</sup> long ago reported evidence to indicate that some could have come from older serotinous cones that opened several years after maturity.

#### STOCKING AND DENSITY

Stocking and density of lodgepole pine trees in the 10th year following cutting and slash treatment are shown in table 2, together with similar previously published data for the first, second, and fifth years. After 10 years, differences in stocking are still highly significantly related to differences in type of seedbed. Also, the difference in stocking between aspects and the treatment-aspect interaction proved to be non-significant.

<sup>5</sup> Clements, F. E. The life history of lodgepole burn forests. U.S. Dept. Agr. Forest Serv. Bull. 79, 56 pp., illus. 1910.



Table 2.--Percent of stocking and numbers of trees per acre by type of seedbed

Seedbed	Distribution: stocked milacre quadrats				Density: trees per acre	
	1950	1951	1954	1960	1954	1960
	Percent				Number	
Burned, piled slash	15	15	28	38	860	1,067
Burned, windrows and concentrations	24	18	28	40	720	900
Slash, windrows and concentrations	38	28	45	47	1,880	1,867
Forest floor	78	74	80	84	7,010	7,433
Skidroad	95	88	96	94	10,380	10,067
Scarified, bulldozer	83	81	88	93	10,730	10,733
Slash, lopped and scattered	83	76	82	82	9,910	8,800

By 1954 stocking increased notably on the two burned seedbeds. One question asked then was whether further improvement would occur on the burns. Between the fifth and tenth years the number of trees per acre increased significantly to an acceptable level on both of the burned seedbeds. Stocking also increased, and the rate of stocking, although not optimum under earlier standards, is now considered adequate.<sup>6</sup> On other seedbeds no real changes in stocking or density took place during this period.

<sup>6</sup> Optimum stocking in 1952 was assumed to be between 65 to 75 percent of milacre quadrats; 40 percent is now considered adequate.

## DISCUSSION AND CONCLUSIONS

Boe's recommendations for disposing of logging slash and rapidly obtaining lodgepole pine regeneration were based on results of the first 5 years of this study. Results of the additional 5 years of study reported here support his original findings related to quick establishment and survival of regeneration.

On most seedbeds where regeneration was established quickly and survival was good, the stands are now too dense. Conversely, burned seedbeds that had been declared understocked during the first 5 years following cutting improved during the second 5-year period. Three seed sources probably contributed to this improvement:

1. Serotinous cones (in the slash) that escaped the damaging effects of fire.
2. Cones that opened on standing overmature timber surrounding the clear cuttings.
3. Nonserotinous cones on reproduction from 5 to 10 years old.

The early variations in stocking and density on the different seedbeds and their status after 10 years have definite practical implications. They suggest a need for some changes in application of slash disposal methods.

In areas where timber production is the highest use, obtaining early regeneration at adequate density should be the primary goal. Results from this study show that this goal can be achieved on burned seedbeds, provided they are adequately supplied with seed. However, extremely careful burning of slash is required to avoid destruction of all seed-bearing cones. Moreover, at least a few well-distributed trees must become established on the burned seedbeds very soon after logging and supply seed to fill in areas not supplied by adjacent timber. At least 75 percent of the area should have a burned surface after slash treatment. Such a seedbed has a better chance of creating optimum-stocked stands than most seedbeds produced by current practice, but it will require a longer regeneration period.

In areas where it seems imperative to restore tree cover rather soon after logging, no changes from present practices are proposed. Dozer bunching of slash either in small, well-distributed piles or short windrows reduces fire hazards to acceptable levels and provides conditions suitable for the immediate establishment of reproduction. All seedbeds except burned ones and those where heavy slash concentrations remain are naturally supplied with adequate quantities of seed and become restocked promptly. The original recommendation to keep burned seedbeds small (1/20 acre or smaller) and well distributed and to be sure that they occupy no more than 25 percent of the total area should be followed. This type of slash treatment can be recommended for areas subjected to heavy recreational use and for soils having high erosion potentials.

These suggested practices have resulted frequently in overly dense stands of reproduction, which pose a threat against attainment of optimum usable growth. The need for precommercial thinning in these stands is obvious. As more lodgepole pine timber is cut, overstocked stands are fast becoming the most serious challenge to the technical knowledge and skill of practicing foresters in this type. New techniques in slash disposal must be considered for general use in timber management if natural regeneration is the aim.

Forest managers in central Montana must be alert to alternatives in slash disposal when they plan cuttings in lodgepole pine. Piling dry slash with a bulldozer usually results in prompt overdense regeneration, which requires early thinning to control density. Prompt regeneration well spaced may also be obtained by planting, but at a greater cost than natural regeneration. Greater use of fire in slash disposal may result in a uniform seedling stand of acceptable density, but it would require a longer time than the other methods mentioned. Because refinements in methods of disposing of lodgepole pine slash offer promise in obtaining acceptable stands as less cost, further research on seed supplies and on disposal methods is needed.





# Research Note

UNITED STATES DEPARTMENT OF AGRICULTURE  
FOREST SERVICE

**INTERMOUNTAIN FOREST & RANGE EXPERIMENT STATION**  
OGDEN UTAH

U.S. Forest Service  
Research Note INT-18

1964

## DEVELOPMENT OF YOUNG WESTERN WHITE PINE PLANTATIONS

Raymond J. Boyd and Glenn H. Deitschman<sup>1</sup>  
Division of Forest Disease and Timber Management Research

### ABSTRACT

Study of two young western white pine plantations reveals their growth to be much faster than that of natural stands of comparable age. Data from a third plantation provide additional information on effects of site and density.

### INTRODUCTION

Among the many advantages claimed for the establishment of stands by planting are a shorter regeneration period, better spacing, control of composition, and faster growth rates. Advantages and disadvantages vary with species, economics, and site capabilities.

What claims can be made for western white pine plantations? Measurements made on three young white pine plantations in Montana and Idaho provide some quantitative information on growth, stand structure, and effects of density and site that should be useful in planning regeneration and management.

<sup>1</sup> Research foresters. Authors headquartered at Forestry Sciences Laboratory, Moscow, Idaho, maintained by Intermountain Forest and Range Experiment Station in cooperation with the University of Idaho.

## LOCATION AND PLOT ESTABLISHMENT

Two of the plantation areas studied had been denuded by the disastrous forest fire of 1910. One, located on the Lolo National Forest near the head of the St. Regis River in Montana, was planted in 1918 and contains a small natural component of western larch, lodgepole pine, and Engelmann spruce. Planting of the other area, near Cathedral Peak on the Coeur d'Alene National Forest in Idaho, was accomplished in 1924 following a second fire in 1919. Because of the double burn, this plantation remains virtually pure white pine.

In 1947, four 1/10-acre permanent sample plots were established in the 29-year-old St. Regis plantation and five in the 23-year-old plantation near Cathedral Peak.<sup>2</sup> Measurements taken at that time, and again in 1952 and 1957, included crown class, diameter, and total height. Site quality on both sets of plots ranged from fair to excellent.

The third plantation was established at the Deception Creek Experimental Forest in Idaho in 1936 following harvest of an old-growth white pine stand and controlled broadcast burning as a site preparation measure. Originally the planting was designed as a comparison of 4-, 6-, and 8-foot spacings, but variations in survival plus the entry of natural reproduction of white pine and associated species modified the planned spacings. Measurements of diameter, total height, and height to live crown were taken in 1958 on five temporary 1/10-acre plots to determine effects of differing densities on growth and natural pruning. Site quality as measured by 8-year height growth intercept was uniform among these plots.

## RESULTS FROM ST. REGIS AND CATHEDRAL PEAK PLANTATIONS

Growth rates during the 10-year period of measurement were similar on both areas (table 1). Annual increases averaged about 200 cubic feet per acre in volume and slightly less than 0.2 inch in tree diameter. Mortality was higher in the older stand because of heavier densities, but was limited to small subordinate trees.

The effect of site differences among these plots almost entirely obscured the effect of stocking variations. Average periodic volume increment, ranging from 175 to 264 cubic feet per year, generally corresponded to the range of site classes (SI 50 to SI 70).

The freedom of young planted western white pine from intense competition contrasts with early conditions in fully stocked natural stands. The benefits of uniform stocking include less skewed diameter distribution and faster growth (fig. 1). During the 10-year measurement period, the St. Regis plantation maintained a growth margin over comparable natural stands of about 50 percent in average stem diameter, 30 percent in diameter of dominant and codominant trees, 20 percent in basal area per acre, and 35 percent in volume per acre (table 2). At the Cathedral Peak plantation, concentration of growth on fewer trees resulted in even better performance.

---

<sup>2</sup> Plots were established by C. A. Wellner and A. E. Helmers.

Table 1. -- Stand and stocking changes in the Cathedral Peak and St. Regis plantations over a 10-year period

Plantation and stand age (years)	Trees	Average	Basal area	Volume
	per acre	diameter	per acre	per acre
	<u>Number</u>	<u>Inches</u>	<u>Sq. ft.</u>	<u>Cu. ft.</u>
Cathedral Peak:				
23	900	4.2	85	1,000
28	880	5.1	125	2,020
33	860	6.0	167	3,150
Average annual change	-4	0.18	8	215
St. Regis:				
29	1,135	4.7	133	2,280
34	1,060	5.4	168	3,260
39	870	6.4	192	4,290
Average annual change	-27	0.17	6	201

Table 2. -- Plantation growth expressed as percentage of values for natural stands<sup>1/</sup> at equivalent ages

Plantation and stand age (years)	Trees per acre	Mean d.b.h.		Basal area per acre	Cu. vol. per acre
		All trees	D & CD <sup>2/</sup>		
----- <u>Percent</u> -----					
Cathedral Peak:					
23	21	221	181	105	131
28	25	222	144	119	155
33	30	214	131	127	164
St. Regis:					
29	48	157	131	113	136
34	53	150	135	119	136
39	51	152	130	119	134

<sup>1/</sup> Haig, I. T. Second-growth yield, stand, and volume tables for the western white pine type. U.S. Dept. Agr. Tech. Bull. 323, 67 pp. 1932.

<sup>2/</sup> Dominant and codominant trees only.

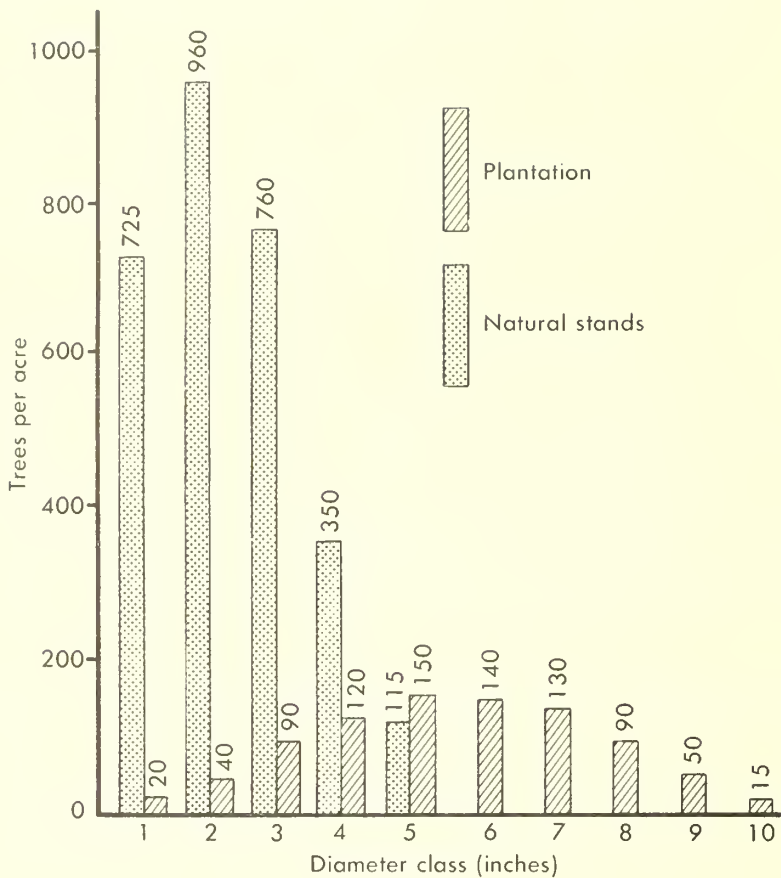

Figure 1.--Number of trees per acre by diameter class in a 33-year-old western white pine plantation (Cathedral Peak) as compared to the number in natural stands of similar age.



## RESULTS FROM DECEPTION CREEK PLANTATION

Evidence of how much growth reduction can be caused by increased plantation density is provided by temporary plot data from essentially uniform sites at the Deception Creek Experimental Forest (fig. 2).

When the plantation was 23 years old, the diameter of the average white pine was 20 percent greater at a basal area stocking of 73 square feet per acre (1,370 trees) than at 113 square feet (2,500 trees) per acre. But, thus far, density of this range has not affected growth of the 200 largest white pine trees per acre. Diameters of these potential crop trees average about 5 inches on all plots; their height growth since establishment has averaged nearly 2 feet per year.

Conditions of heavier stocking have hastened the shading out of lower limbs, but not to any important degree (fig. 3). At 23 years, trees in the most densely stocked areas differed from those in the least densely stocked areas by only about 2 feet in height to live crown.

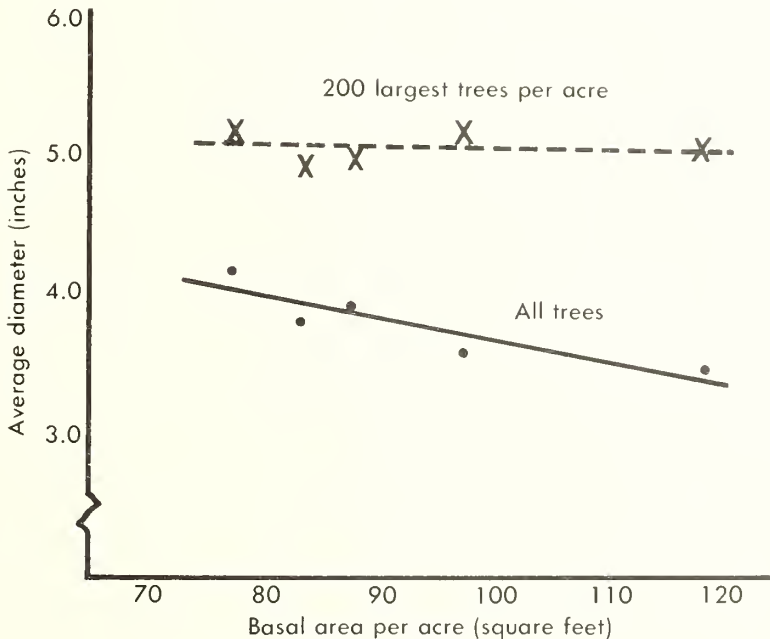

Figure 2. --Effect of stocking on average diameter of 23-year-old planted western white pine, Deception Creek Experimental Forest.

## DISCUSSION

Performance of western white pine in young plantations was markedly superior to that of natural stands. One reason for this superiority is that plantations become quickly established, whereas natural regeneration of western white pine stands may take many years. Second, the growth capabilities of the site are utilized by fewer, well-distributed trees. Other obvious advantages of plantations include easier application of cultural treatments and much greater control over species composition than can be achieved in natural stands.

The last periodic annual increment measurements differed by 50 percent between fair and excellent sites. This divergence demonstrates the importance of properly evaluating site quality before assigning area priorities for planting. Close spacing and consequent early stand closure quickly retard the diameter growth of the average plantation tree. However, time for starting needed thinnings is provided by the apparent delay of adverse effects on the larger potential crop trees.

Higher stand densities resulted in slightly earlier mortality of lower crown portions. Since dead branches persist on western white pine for 50 years or more,<sup>3</sup> early shading out of lower limbs probably would not improve wood quality significantly at harvest.

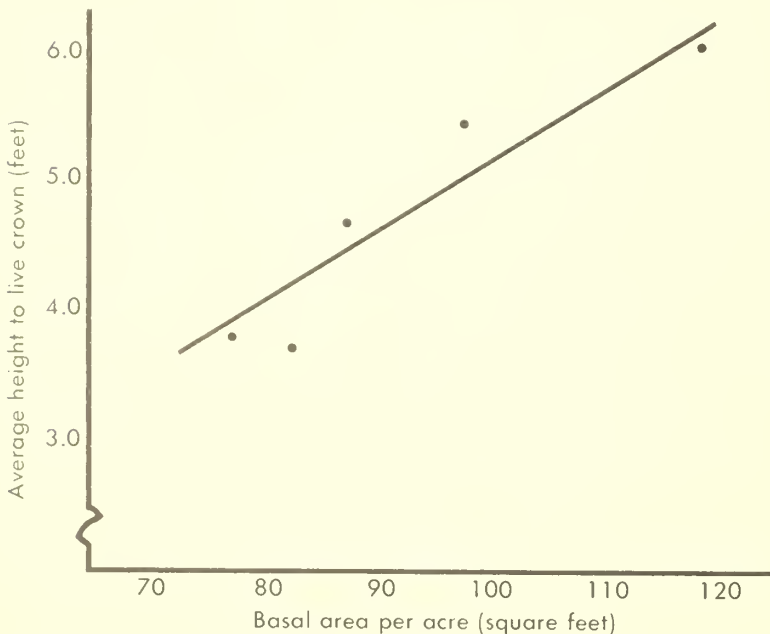

Figure 3.--Effect of stocking on height to live crown of 23-year-old planted western white pine, Deception Creek Experimental Forest.

<sup>3</sup> Rapraeger, E. F. Development of branches and knots in western white pine. Jour. Forestry 37: 239-245. 1939.







# Research Note

UNITED STATES DEPARTMENT OF AGRICULTURE  
FOREST SERVICE

**INTERMOUNTAIN FOREST & RANGE EXPERIMENT STATION**  
OGDEN UTAH

U.S. Forest Service  
Research Note INT-19

1964

CALCULATING THE NATIONAL FIRE-DANGER RATING  
SPREAD INDEX BY COMPUTER

Richard J. Barney, Research Forester  
Division of Forest Fire Research

ABSTRACT

Changeover from use of the Intermountain Model-8 Burning Index Meter to use of the Spread Index of the National Fire-Danger Rating System required a comparative analysis of both systems. This note describes a program written in SPS to calculate various indexes of both systems on an IBM 1620 computer.

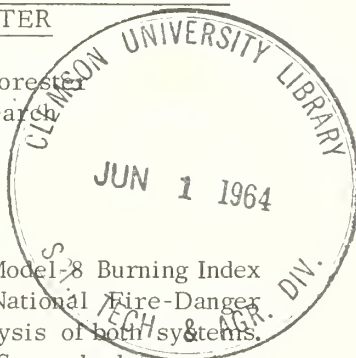

Throughout the United States many forest fire protection agencies are now or soon will be using the Spread Index of the National Fire-Danger Rating System. Changing from one danger rating system to another is not a simple matter of substituting the new for the old. Some type of analysis must be used to aid in establishing the relation between the old system of danger rating and the new system. Information gained from such an analysis is essential in revising existing fire plans and manning and action guides or in designing new ones. Field personnel can use the new system more readily when they understand how it functions in comparison to the system they have been familiar with. Through analysis and conversion, relative indexes begin to take on real meaning and are no longer just numbers but something tangible to the user.

The Northern and Intermountain Regions of the U.S. Forest Service were confronted by the problem of changing from the Intermountain Model-8 Burning Index Meter to the Spread Index of the National System. Since all presuppression and suppression activities in these two Regions were geared to the 9 years of experience with the Model-8 Meter, a simple substitution of systems was not desirable. The experience and knowledge gained while using the Model-8 System could not be ignored. Comparing elements of past fire seasons, rated under the old system, to the National System ratings would provide a basis and background for converting. Automatic processing would facilitate rapid and accurate calculations from data collected by fire-weather stations over many years. With these conditions in mind, a computer program was written to calculate the National Fire-Danger Rating System Spread Index.

The computer program was originally written to calculate both the National and Model-8 Indexes simultaneously. However, this program can be modified to calculate only the National System Spread Index. The program was designed to utilize the readily available U.S. Weather Bureau Fire-Weather Record punchcards, Form 612-17 (formerly 1009-E). The information needed to compute the indexes for the National System with the possible exception of Herbaceous Stage is on these Weather Bureau punchcards.

Input data necessary for computing the National Spread Index are:

1. Dry Bulb Temperature
2. Wet Bulb Temperature
3. Wind Speed
4. 24-Hour Precipitation

One remaining item of input necessary to compute the Spread Index is the Herbaceous Stage. Most of the fire-weather stations in the Intermountain area did not observe and record information about condition of vegetation. Therefore, the program was written with provisions for calculating the indexes by using preselected dates to show changes in the various stages of curing. The program can also be run using the same vegetative stage throughout the season.

Program output includes all of the input information for each day plus the following:

1. Fine Fuel Moisture
2. Adjusted Fuel Moisture
3. Buildup Index
4. Fine Fuel Spread Index
5. Spread Index (timber)

Once the output information is available on cards, numerous methods of analysis are possible. Individual factors or combinations of several factors can be compared and correlated to the causes, sizes, number, and growth of fires, and difficulty of suppression. Results from these comparisons can be used to revise plans for manning and action and also to provide field personnel with the essential relations between the old and new rating systems.

The program has been written in the Symbolic Programming System (SPS). Table look-up is the basic method of determining the various indexes. Machine results are identical to those determined by using the U.S.D.A., Forest Service, National Fire-Danger Rating System, Spread Phase 5100-26 (5-63) Forest Fire-Danger Tables 1 to 6. The program was written specifically for an IBM 1620 computer with a 40 K storage capacity, indirect addressing, and hardware divide.

This computer program was written under a contract with the University of Idaho Computer Center by Dr. H. Ward Crowley. A copy of the program titled, "Program to Compute Model-8 Burning Index and National Spread Index," a writeup of operating instructions, a program card deck, or more detailed information may be obtained on request to Dr. H. Ward Crowley, Computer Center, University of Idaho, Moscow, Idaho. General information concerning this program may also be obtained from the Northern Forest Fire Laboratory, Missoula, Montana.



# Research Note

UNITED STATES DEPARTMENT OF AGRICULTURE  
FOREST SERVICE

**INTERMOUNTAIN FOREST & RANGE EXPERIMENT STATION**  
OGDEN UTAH

U.S. Forest Service  
Research Note INT-20

1964

## FOREST AREA AND TIMBER VOLUME IN WESTERN SOUTH DAKOTA<sup>1</sup>

A. P. Caporaso, Research Forester  
Division of Forest Economics and Recreation Research

### ABSTRACT

Inventory of forests in Western South Dakota completed in 1960 reveals that this portion of the State has 1.3 million acres of commercial forest land with about 996 million cubic feet of merchantable wood. Ponderosa pine is the principal species on all but 23,000 acres of this commercial forest, and it makes up 95 percent of the total cubic volume. Eighty-three percent of the timber is publicly owned.

In 1960, the forests of Western South Dakota covered 1,399,000 acres, which is about 2.9 percent of the State's total land area.<sup>2</sup> Ninety-four percent of the Western South Dakota forest, or 1,311,000 acres (table 1), is commercially important for timber production and contains 3.4 billion board feet of sawtimber. The other 6 percent includes 20,000 acres of productive forest land reserved from

commercial timber cutting and 68,000 acres that are incapable of producing trees of the size and quality that can be profitably used by forest industry.

About 957,000 acres (or 73 percent) of commercial forest land is National Forest, approximately 99 percent of which is in the Black Hills National Forest (table 2), with the remainder in the Custer

<sup>1</sup>Includes all of Harding, Butte, Lawrence, and Fall River Counties and all lands west of the 103d meridian in Meade, Pennington, and Custer Counties. See map, p. 2.

<sup>2</sup>Information on forest area and volume reported in this Note are part of the results of the first comprehensive forest inventory of Western South Dakota. The 1960 timber survey was completed through the combined efforts of the Intermountain Forest and Range Experiment Station, the Rocky Mountain Forest and Range Experiment Station, and Region 2 (the Rocky Mountain Region) of the Forest Service, U.S. Department of Agriculture.



National Forest in Harding County. Collectively, farmers are the second largest ownership group. Altogether they own 224,000 acres of commercial forest.

There is relatively little nonstocked commercial forest land in these seven counties (only 16,000 acres) and only 45,000 acres of seedling and sapling stands (table 3). Sawtimber covers 708,000 acres and pole-size timber 542,000 acres.

The commercial forest land is dominated by softwood timber (table 4). Ponderosa pine, the principal species in the locality, predominates on 98 percent of the total area, or 1,288,000 acres. White spruce, the only other commercially important tree in this area, is the most important species on 23,000 acres.

The total cubic volume in merchantable live trees 5 inches in diameter and

larger is nearly 996 million cubic feet (table 5). Although sawtimber stands occupy more than half of the commercial forest area, a rather high proportion of the total volume is in smaller size stems. Seventy-six percent of the total cubic-foot volume is in trees smaller than 15.0 inches, and 46 percent is in trees smaller than 11.0 inches.

About 95 percent of the cubic-foot volume is ponderosa pine. White spruce and hardwoods make up the remaining 5 percent. Publicly owned forests account for 83 percent of this volume or 829 million cubic feet.

The estimate of 1,098,000 acres of commercial forest land within the boundary of the Black Hills National Forest (all ownerships inclusive) was determined by a 100-percent type mapping from aerea photos. Therefore, 84 percent of the commercial forest area estimate for Western



South Dakota has no sampling error. The remaining portion, 213,000 acres, was determined from a sampling procedure on aerial photos and has a sampling error of  $\pm 3.45$  percent. The sampling error for the estimate of total cubic-foot volume of

growing stock is 5.6 percent. These errors are on the basis of odds of two out of three that values which would result from a 100-percent inventory would lie within the range indicated by the error.

Table 1.--Area of forest land by land classes, Western South Dakota, 1960

Land class	Thousand acres
Commercial forest land <sup>1</sup>	1,311
Unproductive forest land <sup>2</sup>	68
Productive--reserved forest land <sup>3</sup>	20
Total forest land	1,399
Nonforest land	5,493
All land	6,892

<sup>1</sup> Forest land that is producing or is capable of producing crops of industrial wood and is not withdrawn from timber utilization.

<sup>2</sup> Forest land incapable of growing crops of industrial wood because site conditions are adverse.

<sup>3</sup> Productive public forest land withdrawn from timber utilization through statute or administrative regulation.

Table 2.--Area of commercial forest land by ownership classes, Western South Dakota, 1960

Ownership class	Thousand acres
National Forest	957
Other Federal:	
Bureau of Land Management	9
Indian <sup>1</sup>	--
Miscellaneous Federal	1
Total other Federal	10
State	62
County and municipal	--
Farmer-owned	224
Miscellaneous private	58
All ownerships	1,311

<sup>1</sup> Indian tribal lands and trust allotments, that is lands held in fee by the Federal Government but administered and managed for Indian tribal groups or allotted in trust to individual Indians.

Table 3.--Area of commercial forest land by stand-size and ownership classes for Western South Dakota, 1960

Stand-size class	All ownerships	Public	Private
Sawtimber stands <sup>1</sup>	708	609	99
Poletimber stands <sup>2</sup>	542	373	169
Sapling and seedling stands <sup>3</sup>	45	34	11
Nonstocked area <sup>4</sup>	16	13	3
All classes	1,311	1,029	282

<sup>1</sup> Stands at least 10 percent stocked with growing stock trees with a minimum net volume per acre of 1,500 board feet (International  $\frac{1}{4}$ -inch rule) in sawtimber trees (9.0 inches d.b.h. and larger).

<sup>2</sup> Stands failing to meet the sawtimber stand specifications, but at least 10 percent stocked with poletimber and larger (5.0 inches d.b.h. and larger) trees and with at least half the minimum stocking in poletimber trees.

<sup>3</sup> A stand not qualifying as either a sawtimber or poletimber stand, but having at least 10 percent stocking of trees of commercial species and with at least half the stocking in sapling and seedling trees (less than 5.0 inches d.b.h.).

<sup>4</sup> An area not qualifying as a sawtimber, poletimber, or a sapling seedling stand; i.e., normally an area less than 10 percent stocked.

Table 4. --Area of commercial forest land, by forest types and ownership classes for Western South Dakota, 1960

Forest type	All ownerships	Public ownerships	Private ownerships
Ponderosa pine	1,288	1,008	280
White spruce	23	21	2
All types	1,311	1,029	282

Table 5--Volume of growing stock and sawtimber on commercial forest land by species for Western South Dakota, 1960

Species	Growing stock <sup>1</sup>	Sawtimber
Ponderosa pine	945,330	3,221,492
White spruce	45,726	201,207
Hardwoods	4,679	7,228
Total	995,735	3,429,927

<sup>1</sup> Growing stock volume: Net volume in cubic feet of live merchantable sawtimber trees and pole-timber trees from a 1-foot stump to a minimum 4.0-inch top inside bark.

<sup>2</sup> International  $\frac{1}{4}$ -inch rule.

Table 6. --Volume of growing stock and sawtimber on commercial forest land by ownership classes, Western South Dakota, 1960

Ownership class	Growing stock <sup>1</sup>	Sawtimber
National Forest	781,506	2,687,276
Other Public	47,615	177,911
Private	166,614	564,740
Total	995,735	3,429,927

<sup>1</sup> International  $\frac{1}{4}$ -inch rule.

Table 7. --Volume of growing stock and sawtimber on commercial forest land, by stand-size classes, Western South Dakota, 1960

Stand-size class	Growing stock	Sawtimber
Sawtimber stands	721,522	2,886,038
Poletimber stands	271,054	531,889
Sapling and seedling stands	2,204	7,961
Nonstocked areas	955	4,039
All classes	995,735	3,429,927

<sup>1</sup> International  $\frac{1}{4}$ -inch rule.



# Research Note

UNITED STATES DEPARTMENT OF AGRICULTURE  
FOREST SERVICE

**INTERMOUNTAIN FOREST & RANGE EXPERIMENT STATION**  
OGDEN UTAH

U.S. Forest Service  
Research Note INT-21

1964

## FIELD CORRELATION OF TWO NEUTRON-SCATTERING SOIL MOISTURE METERS

John D. Schultz<sup>1</sup>

### ABSTRACT

Operation of two neutron soil moisture probes of different design was compared under identical conditions. Reports development of a method for depth referencing one probe with respect to the other for obtaining moisture measurements at comparable depths. Correlation curves for data obtained with both probes indicate the best relative positioning of these two probes when one is employed in lieu of the other.

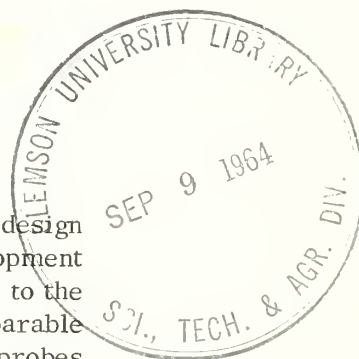

### INTRODUCTION

Measuring soil moisture by the neutron-scattering method has become increasingly common in recent years. As this method gains wider acceptance and usage among scientists, many of the attendant problems will be investigated more thoroughly. One such problem is the substitution of one moisture-measuring instrument for another when a malfunction develops in the instrument used initially in an investigation. The problem is not restricted only to situations of malfunctioning; it may also arise when the original instrument is unavailable for use at a time when measurements must be made to detect changes in soil moisture over short periods of time.

Recent publications have emphasized field calibration of instruments used in the neutron-scattering method (Sartz and Curtis 1961; Van Bavel, Nixon, and Hauser 1963), but such calibrations refer principally to individual instruments for the particular soils in which they are used. What calibration is necessary when two different instruments are used to measure soil moisture in the zone surrounding the same access tube? This paper suggests a solution to the problem of translating data obtained by a substitute instrument into a set of data comparable to what might have been obtained with the original instrument.

---

<sup>1</sup> Formerly research forester, Intermountain Forest and Range Experiment Station, Forestry Sciences Laboratory, Logan, Utah, maintained in cooperation with Utah State University; now on staff of Utah State University.

## PROBE CORRELATION

A calibration curve is provided by the manufacturer for each neutron soil moisture meter. Laboratory calibrations are presented as curves which show the count rate as a percentage of the reference standard (relative count) versus moisture content (volume percent moisture) of the medium or as moisture percent of the soil versus count rate in counts per minute. Some authors (Merriam 1959; Van Bavel 1958) have reported that manufacturers' laboratory calibration curves may be valid for many soils, but Sartz and Curtis (1961) stated that one curve may not apply for all soils. In this investigation, it was assumed, for the sake of simplicity, that curves supplied by the manufacturer are adequate.

Actually, substituting one moisture meter for another should simply be a matter of taking readings with the substitute instrument and converting them to moisture values that the other meter might have yielded. This procedure uses the calibration curves referred to above, but the relation between the two meters is a correlation rather than a calibration in the usual sense. The correlation curve developed is between the soil moisture readings obtained with both probes.

Van Bavel, Nixon, and Hauser (1963, p. 24) pointed out that a direct comparison between field readings obtained with a calibrated and an uncalibrated meter can yield a calibration curve for the latter. This requires, however, that both meters be of the same manufacture and have identical design.

Soil moisture depth probes have a radioactive source attached either to the side of the detector tube at its approximate midlength or to the end of the tube. Both types are in wide use. Our problem hinges on the correlation that may exist between two such differently designed probes that are individually calibrated already.

### PROBES AND ACCESS TUBES USED

A Nuclear-Chicago<sup>2</sup> Model P-19 soil moisture depth probe with a Model 2800 scaler has been used regularly for 2 years to measure soil moisture changes on the same fairly uniform site. This probe is 1.50 inches in diameter, and its radioactive source is near the midlength of the detector tube. It is used in seamless steel access tubing. The instrument was calibrated by the manufacturer specifically for the type of tube used, which is 1.555 inches inside diameter and 1.625 inches outside diameter.

Early in 1963, a Troxler Model 105 moisture probe and Model 200B scaler were purchased. The manufacturer calibrated this probe for the same access tubing. The Model 105 probe is 1.50 inches in diameter and the radioactive source is located at the end of the detector tube. Thus, for purposes of comparing the two probes, site and tube conditions under which comparable readings were obtained were the same.

---

<sup>2</sup>No endorsement or preferential treatment by the U.S. Department of Agriculture is intended by reference to trade names and company names.

## DEPTH REFERENCING OF PROBES

Each measurement of soil moisture by the neutron-scattering method is made at a specific distance below the soil surface. This implies a reference point in the probe to which the depth measurement is made. Its position can be determined in several different ways: (1) by passing a survey meter (Geiger tube) up and down the probe until the highest reading is obtained, (2) by taking 1-minute counts by 1-inch increments as the probe is lowered through an access tube positioned in a container holding a 2- to 4-inch layer of water, (3) by following the field method of curve adjustment described by Stewart and Taylor (1957), or (4) by accepting the manufacturers' statements concerning the location of the effective center of measurement.

In the P-19 probe, this reference point is considered to be where the radioactive source is located. For the Troxler Model 105 probe, all methods except the first listed above can be used. Because the radioactive source is encapsulated immediately below the detector tube, a survey meter would easily locate the source position but it would not detect the effective center of measurement. This point in the Troxler probe is less definable than in the P-19 probe because the neutron cloud may be altered by the presence of a moist or dry stratum that lies between the plane of the source and the assumed effective center. When this occurs, readings may be inconsistent with the average moisture content for that depth. This situation is alluded to by several authors (Van Bavel, Nixon, and Hauser 1963; Lawless, MacGillivray, and Nixon 1963).

Because the P-19 probe was the instrument used initially to obtain data for the soil moisture depletion study under consideration, it is desirable to determine what placement of the substitute probe (in this instance, the Troxler Model 105) yields the highest correlation with soil moisture data obtained with the P-19 probe. Thus, although the manufacturer of the Model 105 probe may state that the effective center is located 4 inches above the bottom of the detector tube, field experience might indicate that a higher correlation with another probe would result from a different point of reference.

Lawless, MacGillivray, and Nixon (1963, p. 506) recognize that the effective center of the Troxler Model 104 probe (1.865 inches diameter) varies with soil moisture content and is not actually a fixed point. So little information is available for the Troxler Model 105 probe that it is probably reasonable to apply the same conclusion to this 1.50-inch diameter probe. As Merriam and Copeland (1963) pointed out, "It is apparent that all the problems involved in obtaining the 'best' neutron probe design are not yet solved."

## ACQUISITION AND EVALUATION OF DATA

Access tubing was installed on the study site to depths ranging from 6 to 10 feet in the summer of 1961. During the 1963 field season, comparative readings were taken with both probes on four dates. The radioactive source in the Model P-19 probe was used as the reference point to which depth readings were taken. For a given moisture reading, the Model 105 probe was referenced so that the source was at one of four positions with respect to the source of the P-19 probe. These positions were: (1) at the same depth, (2) 3 inches lower than the P-19 source, (3) 4 inches lower, and (4) 5 inches lower. In the second, third, and fourth positions, the so-called effective center of the Troxler probe was near the same position as that of the Nuclear-Chicago probe. Only one of these four positions was used on any given date of measurement.

The data presented herein were obtained from 10 access holes and from nine vertical positions in those holes. Depth below soil surface in inches and numbers of observations for each vertical position, in that order, were as follow: 18-10, 30-10, 42-10, 54-10, 66-10, 78-9, 90-7, 102-7, 114-7.

Readings obtained with each probe on the same day were first converted to percent soil moisture (by volume) using the calibration curve provided for each instrument. Data were then paired according to position depth in each access hole and assembled as shown in table 1.

Table 1.--Paired soil moisture readings, Troxler Model 105 probe and Nuclear-Chicago Model P-19 probe <sup>1</sup>

Depth (inches)	Volume percent soil moisture					
	Hole 1		Hole 2		Hole 3	
	105	P-19	105	P-19	105	P-19
	:	:	:	:	:	:
18	37.7	31.5	35.8	30.7	25.0	20.5
30	40.0	29.8	34.4	29.8	27.8	22.4
42	41.4	35.6	37.8	27.4	24.3	19.4
54	44.2	38.4	43.9	37.2	16.4	13.6
66	39.3	34.9	41.0	35.3	24.2	22.0
78	29.7	26.1	27.6	24.6	21.4	15.7
90	36.2	30.3	38.8	33.1	30.4	25.4
102	42.0	37.5	44.7	39.8	33.8	30.1
114	43.4	36.1	43.1	38.9	36.8	32.8

<sup>1</sup> Taken at Davis County Experimental Watershed, Utah, on August 7, 1963.

The assembled data were plotted in figure 1. Because the form of the data so nearly represented straight lines, simple linear correlations were run. The correlation coefficients show that exceptionally high linear correlation exists between the data obtained with the two probes for any of the four relative radioactive source positions. At each relative position for 80 observations, all four coefficients are very highly significant.

Visual consideration of the four graphs indicates that the 4-inch displacement of sources (curve C) would yield the most satisfactory set of substitute data if the Troxler probe were used in lieu of the Nuclear-Chicago instrument. The scatter of data is least for the 4-inch source difference; it is greatest for the placement where both sources are at the same depth (curve A), although the variation of data is not great in any of the four situations.

Plotting of the  $R^2$  or variances of the data reinforces the conclusion drawn above. Figure 2 shows that the highest accounting of variance is obtained when the Model 105 probe is positioned within an access tube so that its radioactive source is 4 inches lower than the P-19 source for a comparable measurement at a specific depth. If the Troxler probe source were positioned 1 inch higher or 6 inches lower than the Nuclear-Chicago probe source, it is reasonable to expect that even greater variation in data would be obtained.

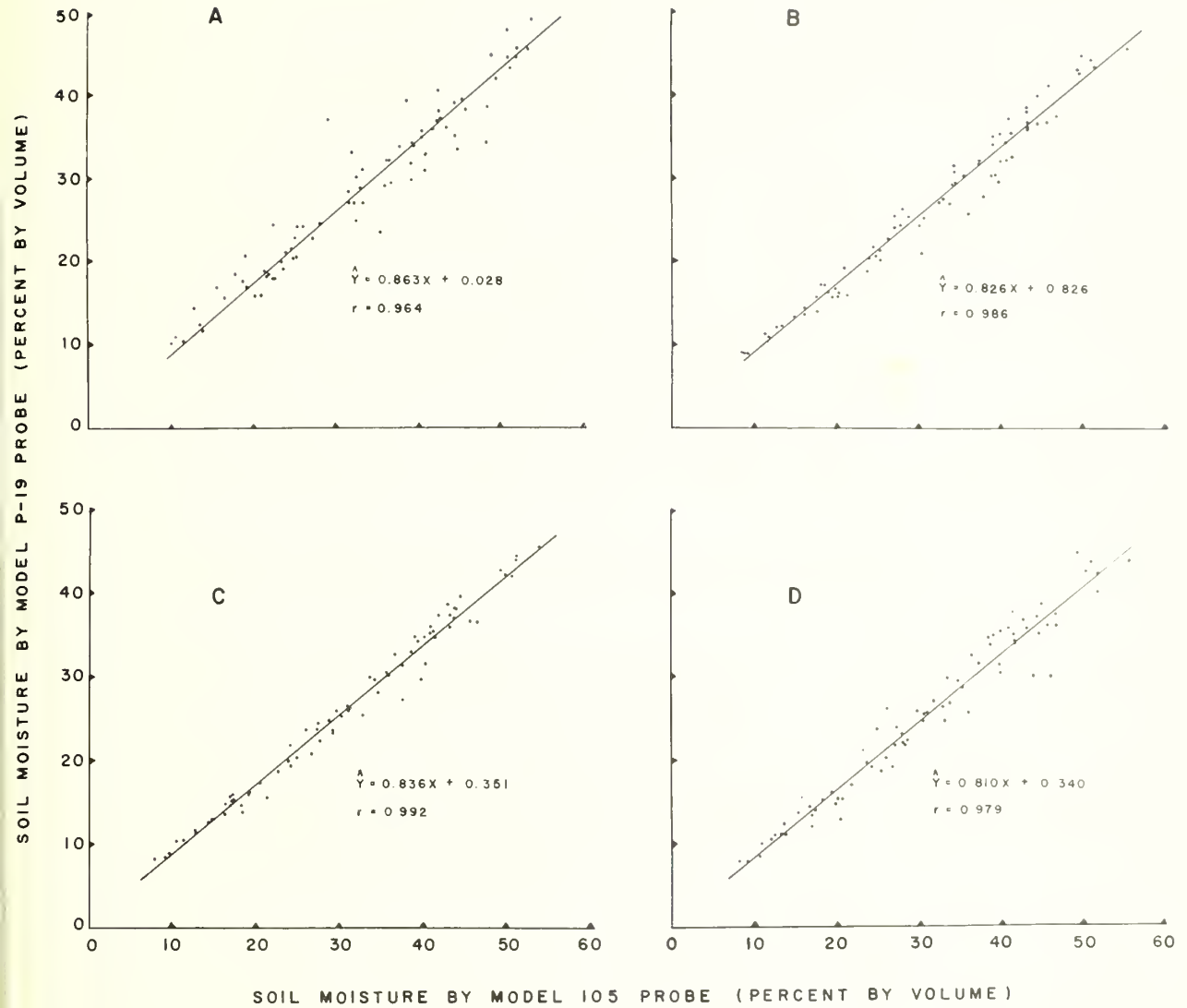

Figure 1.--Relation between soil moisture readings obtained with Nuclear-Chicago Model P-19 moisture probe and Troxler Model 105 moisture probe: A, Radioactive sources at same depth; B, Model 105 source 3 inches lower than source in P-19 probe; C, Model 105 source 4 inches lower; D, Model 105 source 5 inches lower.

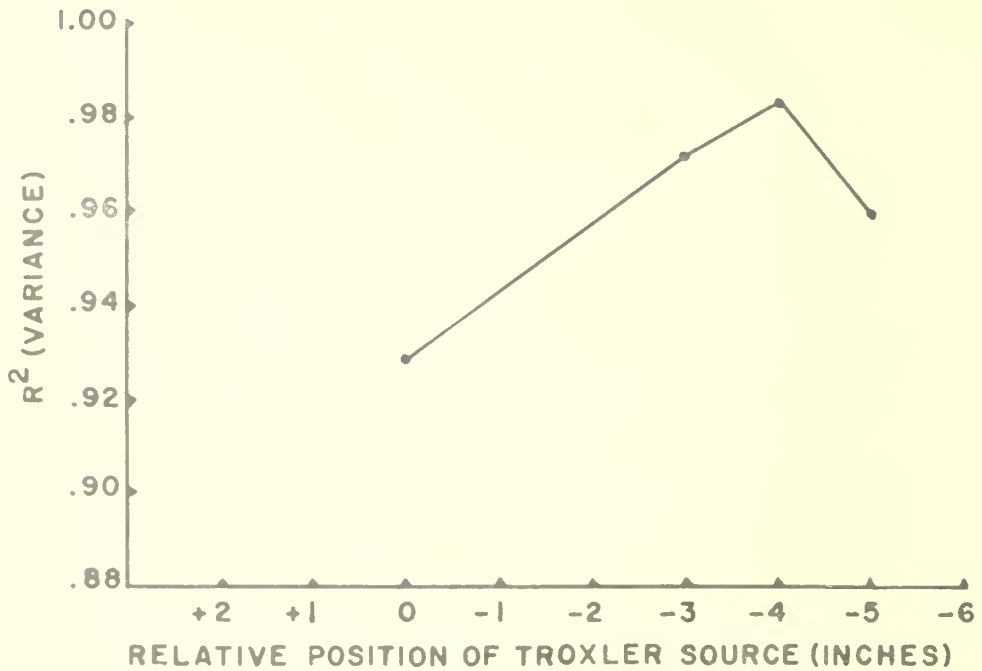

Figure 2.--Variance of soil moisture correlation data with respect to positioning of the Troxler Model 105 probe.

### DISCUSSION

One purpose of this presentation is to point out reasons for field correlation of different neutron probes. Although the method employed here is probably one of the most satisfactory methods available, it is not the only, or necessarily the best, one to use in a particular instance. It must be emphasized that the correlations developed were for two different instruments used on only one study site. Extrapolation of the results to other sites or different conditions is unwarranted.

As was stated earlier, data can be correlated quite easily if two probes have identical dimensions and geometry of construction. Other situations require different handling. Manufacturers of neutron meters and probes have now developed connectors that permit the interchange of probes and scalers. Thus, two entirely different probes might be used with the same scaler, or two different scalers might be used with the same probe. It seems obvious that the correlations discussed herein need to be obtained for instruments that may be used interchangeably on the same site.



## LITERATURE CITED

- Lawless, G. Paul, Norman A. MacGillivray, and Paul R. Nixon.  
1963. Soil moisture interface effects upon readings of neutron moisture probes. *Soil Sci. Soc. Amer. Proc.* 27: 502-507.
- Merriam, Robert A.  
1959. Nuclear probe compared with other soil moisture measurement methods. U.S. Forest Serv. Calif. Forest and Range Expt. Sta. Forest Res. Notes 146, 5 pp.
- \_\_\_\_\_, and Otis L. Copeland, Jr.  
1963. Brief concluding comments about neutron probe sensitivity. *Soil Sci. Soc. Amer. Proc.* 27: 604.
- Sartz, Richard S., and Willie R. Curtis.  
1961. Field calibration of a neutron-scattering soil moisture meter. U.S. Forest Serv. Lake States Forest Expt. Sta. Station Paper 91, 15 pp.
- Stewart, Gordon L., and Sterling A. Taylor.  
1957. Field experience with the neutron-scattering method of measuring soil moisture. *Soil Sci.* 83: 151-158.
- Van Bavel, C. H. M.  
1958. Measurement of soil moisture content by the neutron method. U.S. Dept. Agr., Agr. Res. Serv. ARS-41-24, 29 pp.
- \_\_\_\_\_, D. R. Nielsen, and J. M. Davidson.  
1961. Calibration and characteristics of two neutron moisture probes. *Soil Sci. Soc. Amer. Proc.* 25: 329-334.
- \_\_\_\_\_, P. R. Nixon, and V. L. Hauser.  
1963. Soil moisture measurement with the neutron method. U.S. Dept. Agr., Agr. Res. Serv. ARS-41-70, 39 pp.





# Research Note

UNITED STATES DEPARTMENT OF AGRICULTURE  
FOREST SERVICE

INTERMOUNTAIN FOREST & RANGE EXPERIMENT STATION  
OGDEN UTAH

U.S. Forest Service  
Research Note INT-22

1964

SELF- AND CROSS-POLLINATION OF WESTERN WHITE PINE:  
A COMPARISON OF HEIGHT GROWTH OF PROGENY

Burton V. Barnes<sup>1</sup>

ABSTRACT

Height growth of 9- to 12-year-old western white pine seedlings from self-pollinated parents was compared with that of seedlings from cross-pollinated parents. Data indicate that growth depression from selfing, previously observed in the nursery, continues undiminished after inbred seedlings are outplanted.

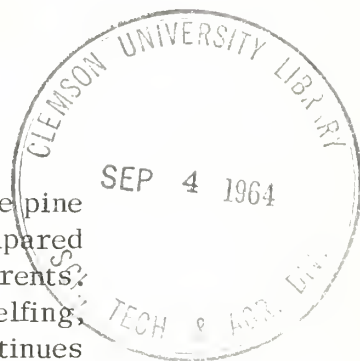

Western white pine seedlings resulting from self-pollination are typically slower growing than seedlings from cross-pollination. Combined data from Squillace and Bingham (1958)<sup>2</sup> and Barnes et al. (1962),<sup>3</sup> indicate the magnitude of this growth depression (measured by epicotyl length adjusted for seed weight) is about 28 percent (table 1). The selfed offspring from completely self-fertile trees show less growth depression (15 percent) than selfed offspring from partially self-fertile trees (40 percent).

<sup>1</sup>Formerly research forester, Forestry Sciences Laboratory, Moscow, Idaho, maintained by Intermountain Forest and Range Experiment Station, in cooperation with the University of Idaho.

<sup>2</sup>Squillace, A. E., and R. T. Bingham. Selection fertilization in Pinus monticola Dougl. I. Preliminary results. *Silvae Genetica* 7: 188-196, illus. 1958.

<sup>3</sup>Barnes, Burton V., R. T. Bingham, and A. E. Squillace. Selective fertilization in Pinus monticola Dougl. II. Results of additional tests. *Silvae Genetica* 11: 103-11, illus. 1962.

Table 1. -- Comparison of height growth of 1-year-old western white pine seedlings: progeny from self-pollination compared with progeny from cross-pollination

Mating (tree number)	Length of epicotyl <sup>1</sup>	Growth of self compared to growth of outcross
	<u>mm.</u>	<u>Percent</u>
<u>Progeny of completely self-fertile trees</u>		
58 X 58	22.0	
58 X 18	<sup>2</sup> 32.0	-31
58 X 58	17.3	
58 X 18	24.6	-30
58 X 58	22.0	
58 X 19	21.0	+5
69 X 69	14.9	
69 X 64	15.2	-2
69 X mm <sup>3</sup>	17.8	-16
<u>Progeny of partially self-fertile trees</u>		
19 X 19	13.0	
19 X 58	21.0	-38
54 X 54	9.1	
54 X 69	14.8	-39
54 X mm	16.7	-46
64 X 64	11.7	
64 X 18	19.0	-38
64 X 58	17.7	-34
64 X mm	20.1	-42

<sup>1</sup> Epicotyl length adjusted for seed weight.

<sup>2</sup> Discrepancy noted in the published 1958 value and changed here according to the 1962 findings.

<sup>3</sup> Mm (multiple mix) was a mixture of an equal volume of pollen from eight trees.

The field performance of 9- to 12-year-old seedlings resulting from self-pollination was compared with that of seedlings from cross-pollinations at three sites in northern Idaho (table 2). The seedlings compared have the same female parent. Parent trees were similar in class; some grew on low-elevation sites (3,000 feet) and others on high-elevation sites (4,800 feet).

These comparisons indicate that growth depression observed in the nursery continued undiminished after the inbred seedlings were outplanted. Selfed progeny from high-elevation female parents showed greater growth depression than progeny from low-elevation female parents. Growth depression of low-elevation selfs and high-elevation selfs was greater at site 1 than at other sites.

At all three sites, survival of progeny from self-pollination was less than that of progeny from cross-pollination (site 1: 58 percent versus 78 percent; site 2: 45 percent versus 58 percent; site 3: 61 percent versus 77 percent).

These observations indicate the importance of using seed collection techniques and nursery practices that decrease the possibility of planting inbred seedlings. Seed should be collected from trees within stands, not from isolated individuals. Seed should not be collected from trees along roads, streams, and meadows where large-crowned, isolated trees are often found. In the nursery, seedlings should be culled on the basis of slow height growth as well as poor root development. Such practices should measurably improve the quality of nursery stock.

Table 2.--Comparison of height growth of 9- to 12-year-old western white pine seedlings: selfs compared with crosses

Site <sup>1</sup>	Female parent--low elevation				Female parent--high elevation			
	Lots	Seedlings		Height growth depression of selfed progeny	Lots	Seedlings		Height growth depression of selfed progeny
		Self	Outcross			Self	Outcross	
		Number		Percent			Number	Percent
1	5	37	149	30	4	16	175	43
2	5	25	111	22	2	7	61	36
3	21	88	807	27	5	24	165	28

<sup>1</sup> Site 1--elevation 3,650 feet, Snyder Creek Drainage, Deception Creek Experimental Forest, Coeur d'Alene National Forest, Kootenai County, Idaho.

Site 2--elevation 2,500 feet, Benton Creek Drainage, Priest River Experimental Forest, Kaniksu National Forest, Bonner County, Idaho.

Site 3--elevation 2,650 feet, Forestry Sciences Laboratory, Blister Rust Resistant White Pine Arboretum, Moscow, Latah County, Idaho.





# Research Note

UNITED STATES DEPARTMENT OF AGRICULTURE  
FOREST SERVICE

**INTERMOUNTAIN FOREST & RANGE EXPERIMENT STATION**  
OGDEN UTAH

U.S. Forest Service  
Research Note INT-23

1964

## TWO AERIAL PHOTO BASAL AREA TABLES

Karl E. Moessner, Research Forester  
Division of Forest Economics and Recreation Research

### ABSTRACT

The two aerial photo basal area tables printed here are based on data from Forest Survey field plots. The tables list average square feet of basal area by total height and crown cover class. Regression formulae and measures of accuracy for the tables are included. Limited tests indicate that estimates based on these tables and direct photo measurements should not differ significantly from estimates of stand basal area obtained by customary ground sampling.

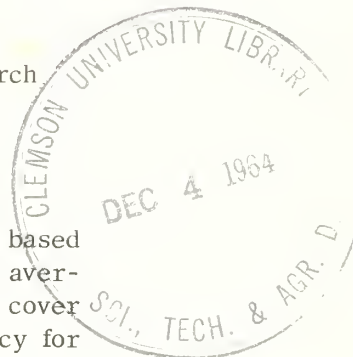

### APPLICATIONS

The two basal area tables published here are initial results of efforts to develop practical methods for estimating stand basal area from measurements on aerial photos.

Basal area, long considered the simplest and most stable indicator of stand stocking, is widely accepted by timber managers as the best measure of levels of growing stock. Few forest management inventories fail to estimate basal area, particularly in younger stands, and many compute it as one step in volume estimating.

Since 100-percent measurement of all trees in the stand is rarely justified, most estimates of basal area are obtained by sampling. The high cost of ground sampling in all forest measurements limits the number of plots that can be used and consequently limits precision of estimates. Aerial photographs, however, provide opportunity to reduce costs greatly and at the same time to produce estimates of stand basal area reliable enough for most management inventories.

The two tables published here use photo measurements of average stand height and crown cover to estimate basal area of a stand. Techniques of measurement have been described previously.<sup>1</sup>

The literatures of photo interpretation and forest mensuration contain some discussion of photo measurements that might be useful in estimating basal area, but they contain no usable tables. For example, Spurr<sup>2</sup> wrote that "basal area is, theoretically, roughly proportional to percent crown closure for a given species and height class." He admitted, however, that "previous efforts to quantify this relationship have yielded poor results."

The Society of American Foresters Committee on Forest Mensuration Problems,<sup>3</sup> discussing photogrammetry under forest surveys, says "we must develop methods of precisely measuring crown density on aerial photos, and these should be more closely related to total basal area or the volume of forest stands." Apparently the committee feels that the widely used crown coverage scales are too subjective for this purpose.

There is, however, support for the use of crown coverage as a photo measure of basal area. In a paper on aerial volume tables,<sup>4</sup> limited analysis showed relatively good correlation (0.810 on 20 sample plots) between percent crown cover measured on aerial photos and the percentage that field basal area is of the yield table basal area for fully stocked stands. In this study the yield table was entered with a site estimated from aerial photos and a stand age estimated from the photo measurement of stand height. Other photo interpreters have noted the relation between crown cover measured on photos and basal area and have used crown cover as an independent variable in aerial photo volume tables for this reason; but few seem to have tried predicting basal area itself from the photo measurements.

Reliability of estimates made with the two following tables is indicated by the standard measures of accuracy included with the equations, and by the results of several tests described later that were made independently of the basic tabular data.

### CONSTRUCTION OF THESE TABLES

The photo basal area tables published here were compiled from:

1. A total of 145 samples obtained from 16-point multiple plot grids measured on the St. Regis unit of the Coeur d'Alene National Forest, Montana. These plots are typical of the white pine and other mixtures found in the northern Rocky Mountains.
2. A total of 85 samples from 10-point multiple plot grids measured on the Coconino National Forest in Arizona, and typical of the ponderosa pine stands found in the Southwest.

---

<sup>1</sup> Moessner, Karl E. Training handbook: basic techniques in forest photo interpretation. U.S. Forest Serv. Intermountain Forest and Range Expt. Sta. 73 pp., illus. 1960.

<sup>2</sup> Spurr, Stephen H. Photogrammetry and photo-interpretation. Ed. 2, 472 pp., illus. New York: Ronald Press. 1960.

<sup>3</sup> Honer, T. G., and L. Sayn-Wittgenstein. Report of the committee on forest mensuration problems. Jour. Forestry 61: 663-667. 1963.

<sup>4</sup> Moessner, Karl E. Aerial volume tables for conifer stands. (Unpublished paper presented at Western Forestry Conference, Victoria, B.C., 1956.)



AERIAL PHOTO BASAL AREA TABLES FOR MIXED SPECIES, NORTHERN ROCKY MOUNTAINS <sup>1</sup>

Gross basal area<sup>2</sup> per acre by average stand height and crown cover

Stand height <sup>3</sup> (feet)	Crown cover <sup>4</sup> (percent)									
	5	15	25	35	45	55	65	75	85	95
	----- Square feet -----									
15	18	14	10	7	4	2	--	--	--	--
20	20	17	14	12	11	9	9	9	9	9
25	22	20	18	17	17	17	17	18	19	21
30	24	23	22	22	23	24	25	27	29	32
35	26	26	26	27	29	31	33	36	40	44
40	28	29	30	33	35	38	42	46	50	55
45	30	32	35	38	41	46	50	55	61	67
50	31	35	39	43	48	53	58	65	71	78
55	33	38	43	48	54	60	67	74	82	90
60	35	41	47	53	60	67	75	83	92	101
65	37	44	51	58	66	75	83	93	102	113
70	39	47	55	63	72	82	92	102	113	124
75	41	50	59	69	79	89	100	111	123	136
80	43	53	63	74	85	96	108	121	134	147
85	45	56	67	79	91	104	117	130	144	159
90	47	59	72	84	97	111	125	140	155	170
95	49	62	76	89	104	118	134	149	165	182
100	52	65	80	95	110	126	142	159	176	193
105	54	69	84	100	116	133	150	168	186	205
110	56	72	88	105	123	140	159	178	197	217
115	58	75	92	110	129	148	167	187	207	228
120	60	78	96	116	135	155	176	196	218	240
125	62	81	101	121	141	162	184	206	228	251
130	64	84	105	126	148	170	192	215	239	263
135	66	87	109	131	154	177	201	225	249	274
140	68	90	113	137	160	185	209	234	260	286
145	70	94	117	142	167	192	218	244	271	298
150	72	97	122	147	173	199	226	253	281	309
155	74	100	126	152	179	207	235	263	292	321
160	76	103	130	158	186	214	243	272	302	333
165	79	106	134	163	192	222	252	282	313	344
170	81	109	139	168	198	229	260	292	324	356

<sup>1</sup> Based on 145 sample locations measured on Coeur d'Alene National Forest, Montana.

<sup>2</sup> Basal area of all trees 5.0 inches d.b.h. and larger, computed from Forest Survey multiple point sample locations.

<sup>3</sup> Average height of the stand, photo measurement checked in the field.

<sup>4</sup> Crown cover of the stand, photo measurement.

Basal Area Equation

$$BA = 0.24701H - 0.77068C + 0.02116HC + 0.00014H^2 + 0.00231C^2 + 15.92380$$

Where BA = basal area per acre in square feet; H = stand height in feet; and C = crown closure in percent.

Multiple correlation coefficient (R) = 0.710. Aggregate deviation. Table 0.0003 percent high.

Standard error of estimate = ±31 square feet or ±52 percent of the mean plot basal area.

Forest Survey, Intermountain Forest and Range Experiment Station, Ogden, Utah, 1964.

AERIAL PHOTO BASAL AREA TABLES FOR PONDEROSA PINE IN THE SOUTHWEST<sup>1</sup>

Gross basal area<sup>2</sup> per acre by average stand height and crown cover

Stand height <sup>3</sup> (feet)	Crown cover <sup>4</sup> (percent)									
	5	15	25	35	45	55	65	75	85	95
	----- Square feet -----									
20	23	32	40	48	58	71	89	110	135	163
25	23	32	41	48	59	74	92	114	140	169
30	24	33	41	49	61	76	96	119	145	176
35	24	33	41	50	63	79	100	124	151	182
40	24	33	41	51	65	83	104	129	157	189
45	25	34	42	53	68	86	108	134	163	197
50	25	34	42	55	70	90	113	140	170	204
55	25	34	44	57	73	94	118	146	177	212
60	26	35	45	59	77	98	123	152	184	220
65	26	35	47	62	80	103	129	159	191	228
70	27	36	49	65	84	107	134	165	199	237
75	28	38	51	68	88	113	140	172	207	246
80	29	39	53	71	93	118	147	179	215	255
85	30	41	56	75	97	124	153	187	224	265
90	31	43	59	79	102	129	160	195	233	274
95	32	46	63	83	108	136	167	203	242	284
100	34	48	66	88	113	142	175	211	251	295
105	39	51	70	93	119	149	182	220	261	305

<sup>1</sup> Based on 85 sample locations measured on the Coconino National Forest, Arizona.

<sup>2</sup> Basal area of all trees 5.0 inches d.b.h. and larger, computed from Forest Survey multiple point sample locations.

<sup>3</sup> Average height of the stand, photo measurement checked in the field.

<sup>4</sup> Crown cover of the stand, photo measurement.

Basal Area Equation

$$BA = -0.81620H - 0.83765C + 0.01902HC + 0.00545H^2 + 0.01831C^2 + 55.32472$$

Where BA = basal area per acre in square feet; H = stand height in feet; and C = crown closure in percent.

Multiple correlation coefficient (R) = 0.840. Aggregate deviation: Table 0.0002 percent high.

Standard error of estimate = ±20 square feet or ±38 percent of the mean plot basal area.

Forest Survey, Intermountain Forest and Range Experiment Station, Ogden, Utah.

These tables relate stand basal area per acre obtained from field measurements to aerial photo measurements of:

1. Average total height of the dominant stand.--This measurement, although made on photos, was checked by comparing it with the average height of the dominants and codominants measured on the ground. Plots with unreconcilable differences between photo and ground measurements were eliminated.

2. Crown coverage of the stand.--This measurement was made only on photos since readings of what the interpreter sees cannot be obtained as precisely on the ground.

Average crown diameter was also measured on photos and tested as a variable, but was not used in constructing these tables.

Basal areas were computed for all live trees 5.0 inches d.b.h. and larger using measurements from the multiple field plots. For the St. Regis data, the per-acre estimate of basal area was obtained from measurements on sixteen 1/256-acre fixed plots for all trees up to 10.9 inches d.b.h., and on 16 variable-radius plots for all trees 11.0 inches and larger. Basal area was measured with a 75-factor prism. For the Coconino National Forest data, the multiple grid included 10 locations, and all trees 5.0 inches d.b.h. and larger were measured on variable plots using a 40-factor prism.

Those plots interpreted on aerial photos as two-storied were treated somewhat differently. Photo and field measurements for each story were used as independent samples. In using the table, the total basal area for a stand classified on photos as two-storied is the sum of the basal areas for both stories.

The tables were constructed by machine compilation using multiple regression analysis. The basic independent variables tested were the stand variables commonly measured on aerial photos: average total height (H), crown cover (C), and average crown diameter (D). Stepwise regression analysis indicated best results were obtained from the first equation (total height and crown cover) and that powers higher than squares were of little advantage. For this reason, the tables produced were prepared from total height and crown cover and their squares and cross products.

The basal area equation and the standard measures of accuracy accompany each table. The standard error of estimate for each table is based on the field plot data used in preparing the table. For each sample, the dependent variable (BA) is an average based upon either 10 or 16 subsamples. Hence, the residual error (standard error of estimate) includes both the error of the mean of the subplots measured on the ground and the error introduced by the regression of basal area to the photo measurements of total height and crown cover. In short, the table may provide estimates closer to the true basal area per acre than is indicated by the published residual error.

## TESTS OF THE TABLES

Several empirical tests were made of the tables using field plot data that were not used in preparing the tables. These data came primarily from the files of Forest Survey. Per-acre estimates from ground measurements of 1/5-acre, 1/4-acre, variable radius, and 10-point locations were used in the comparisons. These tests indicate the comparative precision and accuracy of basal area estimates made wholly through photo measurement. Tests based on the means of 5-plot random groups indicate the relative accuracy of stand estimates made with few plots. Five-plot means were used because available data were limited, and because field estimates are often based on this small a number.

Results of the tests of the northern Rocky Mountain table are shown in the following tabulation.

Test	N	Basal area per acre (means and their standard errors)		Individual estimates			Coefficient correlation
		Photo	Field	Standard error of estimate			
		- - <u>Square feet</u> - -	- - <u>Sq. ft.</u> - -	Percent			
<u>Individual plots</u>							
<u>North Idaho Forest Survey</u>							
1/5-acre field plots	51	101± 8	<sup>1</sup> 119±13	±63	or	±53	0.785
<u>Gravy Creek Timber Sale</u>							
Variable plots (sawtimber only)	26	85± 5	89± 9	±33	or	±37	0.681
<u>5-plot random groups</u>							
North Idaho plots	10	99±11	<sup>1</sup> 118±15	±32	or	±27	0.838
Gravy Creek Sale	5	88± 7	92± 8	±14	or	±16	0.584

<sup>1</sup> Difference between field and photo estimates of basal area significant at 95-percent level.

Although the photo and field estimates from the 51 fixed 1/5-acre plots in northern Idaho are significantly different (see tabulation above), the correlation is high and adjustment of differences could be made easily by means of a few field plots.

In the second test, photo and field estimates of sawtimber basal area from the 26 variable-radius plots on the timber sale cruise are very close, and the standard error of estimate of the individual plots is only one-half that of the fixed 1/5-acre plots.

In both tests, computations based on the mean of 5-plot groups cut this standard error of estimate in half and indicate the table should work well in estimating average basal area per acre for stands.

Several tests were also made of the basal area table for ponderosa pine in the Southwest. These tests were based on standard 1/4-acre plots as well as on the new 10-point multiple locations. The following tabulation summarizes results of these tests.

Test	N	Basal area per acre (means and their standard errors)		Individual estimates			
		Photo	Field	Standard error of estimate		Coefficient correlation	
		- - Square feet - -		Sq. ft.	Percent		
<u>Individual plots</u>							
Coconino National Forest (10-point locations)	52	78±5	70±5	±32	or	±46	0.673
Forest Survey, Arizona (10-point locations)	45	75±5	73±6	±37	or	±51	0.505
Coconino National Forest (1/4-acre plots)	52	78±5	70±6	±39	or	±55	0.567
Navaho Indian Reservation (1/4-acre plots)	26	48±5	<sup>1</sup> 58±5	±23	or	±39	0.637
<u>5-plot random groups</u>							
Coconino National Forest (10-point locations)	10	78±6	<sup>1</sup> 69±6	±15	or	±22	0.802
Forest Survey, Arizona (10-point locations)	9	75±3	73±5	±9	or	±12	0.851
Coconino National Forest (1/4-acre plots)	10	78±6	70±5	±14	or	±20	0.796
Navaho Indian Reservation (1/4-acre plots)	5	48±6	<sup>1</sup> 58±6	±13	or	±13	0.933

<sup>1</sup> Difference between field and photo estimates of basal area is significant at 95-percent level.

Most of these photo and field estimates of basal area are not significantly different even though fieldwork was performed under supervision of three different agencies, namely, the Navaho Indian Reservation, the Coconino National Forest, and the Forest Survey, Intermountain Forest and Range Experiment Station. Results from use of the 10-point locations and 1/4-acre plots were comparable.

Significant improvement in standard error of estimates and in simple correlation was again obtained by using the means of randomly selected 5-plot groups.

In summary, we feel these various tests strongly indicate that basal area of stands can be satisfactorily estimated from photo measurement, and that the photo basal area tables published here will work well on many management inventories.





# Research Note

UNITED STATES DEPARTMENT OF AGRICULTURE  
FOREST SERVICE

*INTERMOUNTAIN FOREST & RANGE EXPERIMENT STATION*  
OGDEN UTAH

U.S. Forest Service  
Research Note INT-24

1964

## MONTANA CHRISTMAS TREE EXPORTS REACH LOWEST LEVEL SINCE SURVEY WAS BEGUN IN 1942

John S. Spencer, Jr., Research Forester  
Division of Forest Economics and Recreation Research

### ABSTRACT

Authoritative data on 1963 exports of Montana Christmas trees by rail and truck show a continuous decline in shipments during the last 4 years to 2.1 million trees, the lowest recorded level. Foliage damage to potential Christmas trees by insects and diseases is considered a principal cause. Compares shipments in 1963 with those of 1962, and summarizes volumes of rail and truck shipments for the past 21 years.

Shipments of Christmas trees from Montana in 1963<sup>1</sup> dropped to 2.1 million trees, the lowest level recorded since the survey was begun in 1942. Shipments in 1963 represent a 6-percent decrease from 1962 numbers<sup>2</sup> and a 50-percent decrease from the peak year, 1956.<sup>3</sup>

<sup>1</sup> This report deals only with shipments of trees to markets outside Montana rather than total Christmas tree production for the State. Each of the transstate railway lines supplied data for trees shipped by rail; the State Forester, the University of Montana, and the National Forests supplied figures on truck shipments.

<sup>2</sup> Farrenkopf, Thomas O. Montana Christmas tree exports decline for third straight year. U.S. Forest Serv. Intermountain Forest and Range Expt. Sta. Res. Note INT-7, 4 pp., illus. 1963.

<sup>3</sup> Wilson, Alvin K. A new high in Montana Christmas tree shipments. U.S. Forest Serv. Intermountain Forest and Range Expt. Sta. Res. Note 44, 4 pp., illus. 1957.

Exports of Christmas trees from Montana have fluctuated widely over the years. In general, shipments increased from 1942 until 1956, but have been in a rapid, general decline since that time. Large-scale foliage damage by insects in 1957 to stands of Douglas-fir--the major Christmas tree species--accompanied the beginning of this decline. Tree diseases of epidemic proportions in subsequent years over part of the range of Douglas-fir rendered additional trees unsalable.

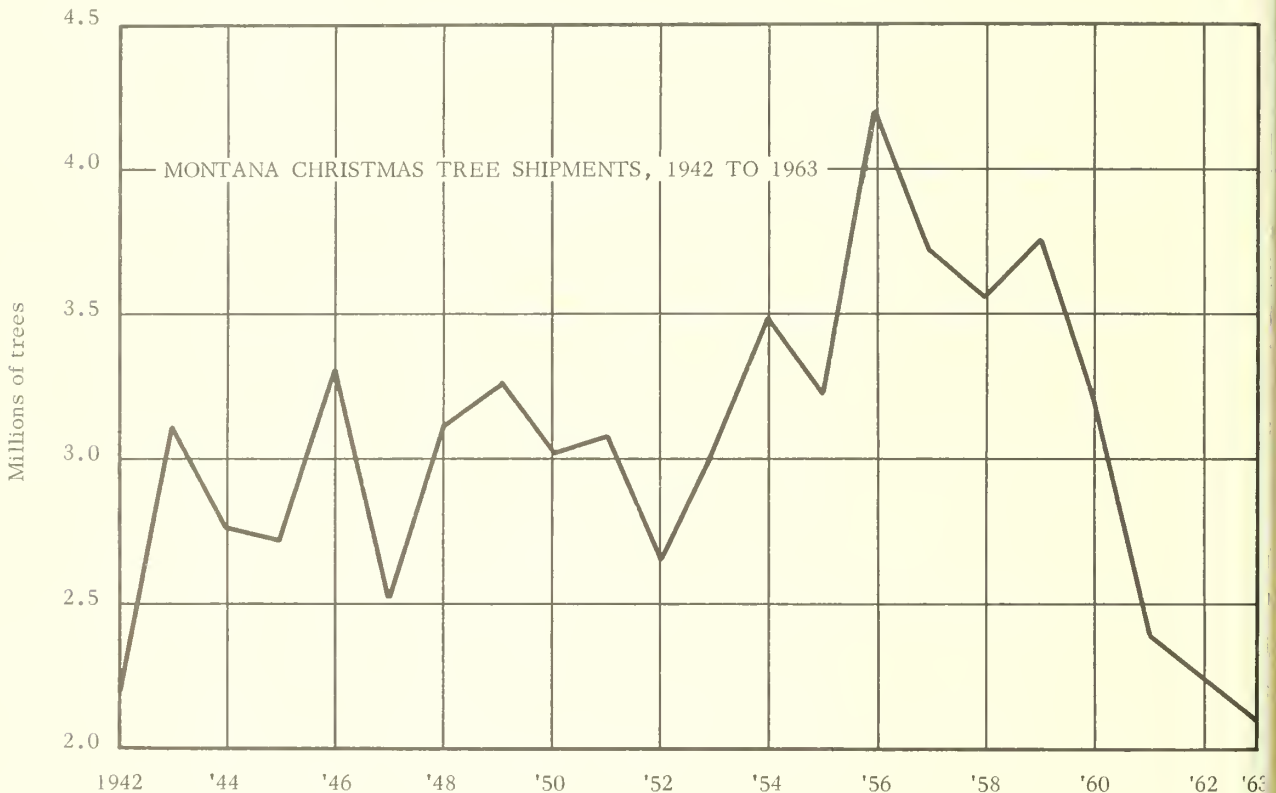

Northern Rocky Mountain Region foresters in the principal Christmas tree producing areas feel that the persistent slump in exports results from continuing insect and disease attacks on Douglas-fir as well as from residual damage from past attacks. However, the increasing capacity of other states to produce trees in plantations for local consumption and export, in addition to sales of artificial trees, probably have made inroads in the markets for Montana trees. That this may be the trend in the future is suggested by the situation on the Kootenai National Forest. This Forest, which is one of the major Christmas tree producing areas in the State and provided 38 percent of the trees shipped by truck in 1963, reports that for that year supply exceeded demand. In the past, demand has almost always been greater than supply in that area.

Forest insects caused greater losses to Christmas tree stock on Montana's National Forests in 1963 than any of the other destructive agents. The Douglas-fir needle midge, spruce budworm, and, to a lesser extent, the Cooley spruce gall aphid continue



to reduce salability of Douglas-fir Christmas trees and to lower the quality of salable trees. The Douglas-fir needle midge remains epidemic in and around the Kootenai and Lolo National Forests, the principal harvest areas. This insect causes discoloration and disfiguration of needles, thereby making the tree unacceptable or unattractive as a Christmas tree. Spruce budworm, which, despite its name, is more widespread on Douglas-fir than spruce, is most serious on the Lolo and Bitterroot National Forests and in the Garnet Range east of Missoula. The larvae of the budworm feed inside the buds and new needles of trees. The resultant defoliation may damage the appearance of the tree sufficiently to prevent its use as a Christmas tree or to lower the grade of a salable tree.

Forest entomologists report no change from 1962 in the status of any of these insects and they see no areas where the insect threat is significantly lessening.

Damage by diseases to Christmas tree stock is usually secondary to that of insects. The most important disease--Rhabdocline needlecast (Christmas tree blight)--has been on the decline for the last 4 years. This disease causes the infected tree to lose the previous year's needles. Foresters found only scattered, light infections near Big Fork, Libby, Fortine, Rexford, and Troy, the areas where the disease is most severe. Forest pathologists point out, however, that the disease is probably cyclic in nature with periods of high and low infection, and that under the proper conditions infections of epidemic proportions may occur again.

Flathead County became the leading producer of Christmas trees in 1963, while Lincoln County dropped to second place. These two counties produced 84 percent of the trees exported from Montana, although their combined total production dropped 2 percent (42,000 trees) from their 1962 total.

Rail shipments of trees continued to decline, reaching the lowest level on record. These shipments were about 19 percent (309,000 trees) less than in 1962. Texas, Oklahoma, California, Missouri, and Kansas, the leading market states, accounted for 70 percent of all rail shipments. Truck shipments increased 25 percent (165,000 trees) over 1962 figures.

Table 1.--Shipments of Christmas trees by rail and truck from Montana, by counties, 1963

County	Rail shipments	Truck shipments	Total	Percent
Thousands of trees				
Flathead	465	437	902	43
Lincoln	556	316	872	41
Lake	147	6	153	7
Sanders	76	30	106	5
Missoula	38	15	53	3
Other	5	14	19	1
<b>Total</b>	<b>1,287</b>	<b>818</b>	<b>2,105</b>	<b>100</b>

Table 2.--Rail and truck Christmas tree shipments from Montana, 1942-1963

Year	Rail shipments		Truck shipments		Total shipments
	Thousands of trees	Percent	Thousands of trees	Percent	Thousands of trees
1942	2,139	97	65	3	2,204
1943	2,931	94	172	6	3,103
1944	2,636	96	120	4	2,756
1945	2,556	94	168	6	2,724
1946	2,867	87	432	13	3,299
1947	2,210	88	306	12	2,516
1948	2,731	87	392	13	3,123
1949	2,817	86	440	14	3,257
1950	2,693	89	325	11	3,018
1951	2,784	90	301	10	3,085
1952	2,375	90	270	10	2,645
1953	2,389	79	631	21	3,020
1954	2,760	79	723	21	3,483
1955	2,855	88	380	12	3,235
1956	3,349	80	847	20	4,196
1957	2,631	71	1,089	29	3,720
1958	2,470	69	1,098	31	3,568
1959	2,741	73	1,010	27	3,751
1960	2,237	70	963	30	3,200
1961	1,662	69	730	31	2,392
1962	1,596	71	653	29	2,249
1963	1,287	61	818	39	2,105

Table 3.--Rail shipments of Montana Christmas trees to leading markets, 1963 and 1962

State	1963		State	1962	
	Thousands of trees	Percent		Thousands of trees	Percent
Texas	328	25	Texas	361	23
Oklahoma	171	13	Oklahoma	218	14
California	161	13	California	166	10
Missouri	128	10	Iowa	157	10
Kansas	114	9	Missouri	157	10
Iowa	109	8	Kansas	138	9
Nebraska	62	5	Nebraska	76	5
Louisiana	47	4	Oregon	52	3
Oregon	38	3	Illinois	48	3
Others	129	10	Others <sup>1</sup>	223	13
Total	1,287	100		1,596	100

<sup>1</sup>Includes 5,000 trees exported to Mexico.



# Research Note

UNITED STATES DEPARTMENT OF AGRICULTURE  
FOREST SERVICE

**INTERMOUNTAIN FOREST & RANGE EXPERIMENT STATION**  
OGDEN UTAH

U.S. Forest Service  
Research Note INT-25

1964

## LEARNING TO ESTIMATE STAND VOLUME FROM AERIAL PHOTOS

Karl E. Moessner, Research Forester  
Division of Forest Economics and Recreation Research

### ABSTRACT

Initial estimates of timber volume made by trainees in photo interpretation were compared with first estimates made by college students in forest mensuration classes. The experiment showed that estimating volume from aerial photographs can be taught as effectively as ground estimating, and in no more time.

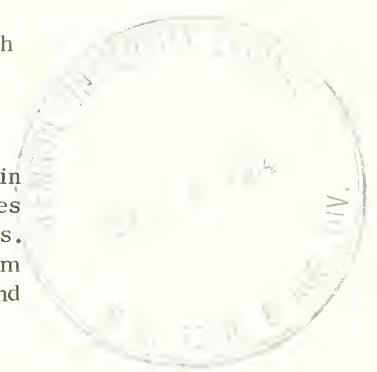

"How long would it take me to learn aerial photo estimating?"

Young foresters often ask this question, and it is a fair question deserving a straightforward answer-- which is seldom given because it is not generally known.

Why do these young men ask it? Some may be idly curious, but many would like to learn an additional useful skill if given the opportunity. All have had classroom training and many have had some field experience in mensuration and volume estimating on the ground. But only a few have learned to make measurements directly on aerial photos, and still fewer have tried the technique of aerial estimating.

A further question is now being asked by many timber managers: Why aren't young foresters trained in photo estimating techniques as well as in traditional ones?

Two answers are readily apparent. First, the lack of skilled aerial photo interpreters makes few available either for forest employment or for giving training. And this very lack may create the impression that the necessary training is excessively long or difficult. Second, timber managers have accentuated the problem by not being willing to accept estimates of volume based on an optimum combination of photo and ground methods. This attitude prevails in spite of the increased efficiency possible in combined aerial photo-ground surveys, particularly when photo volume strata are used,<sup>1</sup> and in spite of the fact that double sampling techniques, which can result in substantial savings in survey costs, have been well documented.<sup>2</sup>

<sup>1</sup> Society of American Foresters. Aerial photography. IN: Forestry Handbook 19: 25. 1955.

<sup>2</sup> Wilson, Richard C. Photo interpretation in forestry. IN: Manual of Photographic Interpretation. Pp. 484-489, illus. 1960.

The idea is widely held that a long training period is necessary for teaching a man to make adequately accurate estimates of timber volume from aerial photographs. However, so far as we could ascertain, no actual study had ever been made to determine any relation between length of time required for training and proficiency in estimating volumes from aerial photos. Accordingly, Intermountain Station set up and carried out a rather informal study, necessarily limited in scope, designed to compare the amount of training necessary to make comparably accurate photo and ground estimates of gross volume.

### THE STUDY

Essentially this study compared 100 photo estimates made by trainees in short courses in photo interpretation with 300 ground estimates made by student foresters. Both groups were presumed to have had no training in estimating at the beginning of the study. The information to be gained from such small groups was admittedly limited but was adequate to permit study with these two objectives:

- To compare the variability of the mean average volume per acre from repeated aerial photo estimates with the variability of the mean average volume per acre from repeated ground estimates when both sets of estimates are made by beginners.

- To compare the variabilities described above with those obtained from first estimates by foresters who had learned to measure stand height and density from photos with acceptable precision, but who had received no previous training in estimating volume from aerial photos.

### PROCEDURE

Photo estimates.--Two groups were given an identical training problem based on panchromatic photos, at 1:12,000-scale, of a 71-acre compartment in the Boise Basin Experimental Forest. One group was trainees taking 5-day short courses in photo interpretation. They had learned how to use their instruments but had had no previous training or experience in photo estimating. The second group was eight foresters who had achieved controlled precision in photo interpretation and measurement after about 2 months of on-the-job training.<sup>3</sup> All estimates by both groups were first attempts at volume estimating. No one in either group had ever visited the area estimated.

Each trainee received a stereogram with an overprinted dot grid having 51 regularly spaced dots within the compartment. Every fifth dot (11 in all) was marked for photo measurement. Trainees were instructed to classify the circular 1/5-acre surrounding each dot into one of four strata based upon height of dominant trees within the sample plot. At each of these 11 points the trainees measured and recorded average total height, crown diameter, and crown coverage of the dominant stand. From these measurements they read average per-acre volume from an aerial volume table and recorded it for each plot. Finally the mean volume for each classification was weighted by the number of plots so classified to compute a mean per-acre volume for the whole compartment. Admittedly the standard error of a mean from so few samples would be high; but since these trainees were expected to complete their estimates in about 4 hours, the number of measured plots had to be kept small.<sup>4</sup>

The volume estimated by each trainee was compared with the accepted gross board-foot volume for the compartment calculated from a 100-percent cruise of all trees 11 inches and larger d.b.h. The difference was used in computing the variability of repeated photo estimates.

Ground estimates.--We were unable to obtain ground estimates by students for the same tract for comparison. However, through the courtesy of forestry schools at four universities<sup>5</sup> we obtained 300 estimates by students from ground cruises made by classes in mensuration. These estimates, by 2- or 3-man

---

<sup>3</sup> Moessner, Karl E. Graphic control charts--a possible aid in photogrammetric training. *Photogrammetric Engin.* 24: 643-650, illus. 1958.

<sup>4</sup> A skilled photo estimator probably would measure all 51 locations on this 71-acre tract and complete his estimate in less than 1 day.

<sup>5</sup> University of Washington, Montana State University, University of Michigan, and Purdue University.

crews, were made on 40- to 80-acre tracts and were predominantly 10-percent estimates based on 20 to 40 circular 1/5-acre plots. Species, d.b.h., merchantable height, and occasionally other features were measured or estimated. In a few cases, noncircular plots or strips or 20-percent cruises were used. Presumably, usual ground cruising procedures and volume tables were used by the students in converting field measurements to estimates of per-acre volume. Each student estimate listed the gross board-foot volume, which we compared with the accepted volume for the tract. Thus, the information was comparable to that submitted by the trainees in photo interpretation.

Analysis. --The first step in the analyses of the photo and ground estimates was to compute the difference between the accepted volume for each tract and the students' or trainees' estimates. These differences were then reduced to percentages of the accepted volumes. This approach was necessary because the reported mean volumes ranged from 3,000 board feet per acre for eastern hardwoods to 100,000 board feet per acre for some west coast conifers. The variation of these percentages was fairly constant for all ground surveys regardless of their location or intensity. The proportion of the total number of estimates within a given percent of the accepted volume was then computed and used in comparing the results of photo estimating with those of ground estimating (table 1). The slight reduction in variability of estimates based on ground surveys might be attributed to the fact that the mean of the estimates was considered to be the true volume instead of volume estimated from a 100-percent cruise.

### RESULTS AND DISCUSSION

This comparison of first attempts at volume estimation indicates that repeated photo estimates of total volume are nearly as precise as repeated ground estimates when both are made by inexperienced or only partially trained personnel. It also indicates that students can learn to estimate volume from aerial photos virtually as accurately as they now learn to estimate volume by ground measurements, and they can learn both in about the same length of training time. The study also shows that foresters who have acquired controlled precision in stereo measurement techniques can markedly improve the accuracy of their estimates with comparatively little increase in experience.

The typical student forester receives considerable training in use of the compass, tape, Abney level, and other ground mensurational tools before he tries to cruise timber. Rarely does he receive equal instruction in making basic photo measurements. This may account for some of the feeling that a long training period is necessary for teaching a forester to estimate volume accurately from photos. The usual graduate fresh from forestry school is not a proficient ground cruiser. Expert timber cruisers, whether they use ground measurements or photo techniques, have developed their superior skill through intensive training and experience. Added practice in photo measurement appears to produce as much increased skill in estimating as added experience in ground measurement.

Table 1. --Proportion of the total number of estimates within given percent of accepted true volume

Percentage difference from accepted volume	Photo estimates by 100 trainees taking 5-day short courses	Ground estimates by 300 students in mensuration classes	Photo estimates by 8 foresters with on-job training
----- <u>Percent of total number</u> -----			
Within 5	14.1	15.8	37.5
Within 10	31.3	34.2	50.0
Within 15	46.5	50.5	90.0
Within 25	64.6	72.9	
Within 50	92.0	94.3	
Within 75	99.0	98.2	
Within 100	100.0	100.0	

PERCENT  
of CRUISES

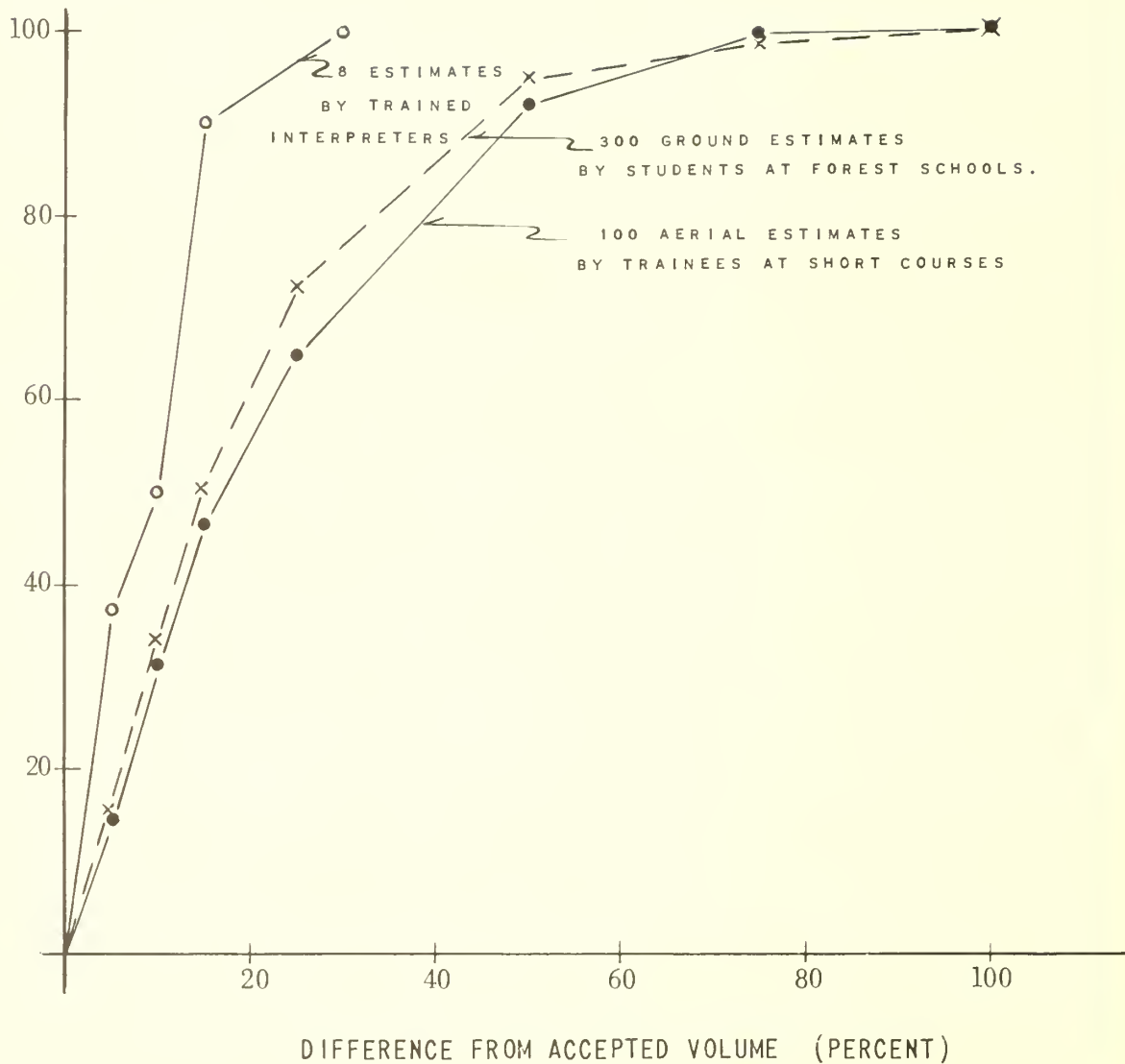

Figure 1.--Comparative precision of initial aerial and ground estimates of gross volume.



# Research Note

UNITED STATES DEPARTMENT OF AGRICULTURE  
FOREST SERVICE

INTERMOUNTAIN FOREST & RANGE EXPERIMENT STATION  
OGDEN UTAH

U.S. Forest Service  
Research Note INT-26

1964

## ESTIMATING SLOPE PERCENT FOR LAND MANAGEMENT FROM AERIAL PHOTOS

Karl E. Moessner and Grover A. Choate  
Research Foresters  
Division of Forest Economics and Recreation Research

### ABSTRACT

Describes and discusses a simple method of measuring slope on aerial photos of the type available to most land managers. Comparative data indicate photo estimates of average slope percent for an area are reliable and are far less costly than estimates made from measurements on the ground.

### INTRODUCTION

"Can I measure slope percent on aerial photos? If so, how do the measurements compare in reliability and cost with those made on the ground?"

Land managers are taking an increasing interest in answers to questions such as these. Few inventory surveys of wild lands--whether for timber, grazing, water, recreation, or wildlife--neglect measurement of slope percent, but the advantages and the ease of photo measurement are not widely known.

First, the matter of reliability of estimates. Evidence from 322 paired photo and ground measurements on the type of photos readily available to land managers indicates that for most inventory purposes photo estimates of slope do not vary significantly from those made on the ground. Photo measurements are especially close to ground measurements on areas where the ground is not obscured by trees. At 34 locations, where the ground was visible on the aerial photos and the ends of the slope line used for ground measurement could be located precisely on the photos, the two sets of measurements showed little difference.<sup>1</sup> Although the variation

<sup>1</sup> Correlation coefficient was 0.941. The mean slope percent and standard errors for photo and ground measurements were  $19.50 \pm 2.94$  and  $19.12 \pm 2.51$ , respectively.

between individual ground and photo readings is somewhat greater where tree cover obscures the ground on photos, the differences between these measurements at 187 locations still were not significant.<sup>2</sup>

These data highlight some results of research into the accuracy of slope measurements for land management purposes. The 322 paired sets of field and office measurements mentioned above were taken by several investigators working independently on different management and research projects in the Intermountain and Pacific Northwest areas. Other findings of this research, such as the close similarity of results by different photo interpreters working under different conditions, are described more fully in a companion report.<sup>3</sup>

Reliability, however, is only one factor in sampling efficiency. What is the saving in cost?

On almost all inventory surveys, estimates of slope made on the kind of photos usually available to land managers are much less expensive than ground estimates. This is indicated from a comparison of the number of measurements that can be made per man-hour. Experience indicates that photo measurements of slope can be made at a sustained rate of 5 to 10 per man-hour--a rate that is practically unaffected by ground conditions. Field measurements usually require far more time. On intensive surveys with samples only a few chains apart, a two-man survey party may make several slope measurements per hour. But on extensive surveys, based on samples several miles apart in rugged or inaccessible country, only a single slope measurement may result from a whole day's work by a two-man crew.

Photo measurement is of particular advantage on sites where several ground measurements must be averaged to obtain an estimate of general slope over a long distance. For example, when average slope is needed over one-fourth mile or more of uneven or forested terrain, lack of visibility usually means several short ground observations must be made and averaged. The time required for making such a series of observations is far longer than would be required for estimating average slope percent from the single set of photo measurements.

The necessity of going on the ground to gather additional kinds of information is often given as a reason for not using photo measurements of slope. However, the cost of ground measurement always limits and reduces the intensity of sampling and, therefore, the reliability of these estimates. When more reliable slope estimates are needed, photo measurement provides opportunity to increase the intensity of sampling at a fraction of the cost of additional fieldwork.

The following pages describe in detail the relatively simple procedures recommended for photo measuring of slope on forest and other wild land inventories. These techniques are simpler than first glance would suggest. They can be learned much easier than the measurement of tree heights on photos. Men familiar with aerial photos can learn to make acceptably precise slope measurements in five or six 2-hour training periods.

---

<sup>2</sup> Although the correlation dropped to 0.857, the mean slope percents and their standard errors remained very close-- $32.48 \pm 1.38$  and  $33.32 \pm 1.45$  for photo and ground measurements, respectively.

<sup>3</sup> Moessner, Karl E. Learning to estimate stand volume from aerial photos. U.S. Forest Serv. Intermountain Forest and Range Expt. Sta. Res. Note INT-25, 4 pp., illus. 1964.



## MEASUREMENT TECHNIQUES

Several instruments, such as the Stereo Slope Meter, the slope measuring parallax wedge, and various floating line devices, have been especially designed for measuring slope on aerial photos and have been well described.<sup>4</sup> None of these instruments, however, is easier to use on photos nor is likely to produce more precise readings than can be obtained from the simple parallax wedge or the parallax bar.

Slope percent obtained from aerial photos is a combination of two measurements: elevation difference and horizontal distance. Its formula is:

$$\text{Slope percent} = \frac{\text{elevation difference}}{\text{horizontal distance}} \times 100.$$

Since elevation difference is determined by parallax measurements, the stereopair of photos must first be set up for such measurement.<sup>5</sup> Regardless of whether parallax wedge or parallax bar is to be used, this setup consists of properly orienting and taping photos to the desk to prevent their movement during measurement. The photos are studied under stereo viewers, and a line is drawn through the location in the direction of steepest slope. Two points are selected on this line straddling the location (fig. 1, location A). These are usually 500 or more feet apart, but a shorter distance may be used on large-scale photos or where opportune photo detail facilitates measurement.

The parallax difference between the two points is measured to the nearest 0.001 inch if a parallax wedge is used, or to the nearest 0.01 millimeter when using a parallax bar. The horizontal distance between the two points is then measured on the photo by means of a rule reading in 0.001 foot. Parallax wedges designed for this work have rules of this type printed on them. Both parallax difference and horizontal distance are converted to feet on the ground at the local scale of the aerial photos. Computation of difference in elevation is simplified by use of a standard table of parallax factors (table 1).

The following example, measured on figure 1, location A, illustrates this procedure:

$$\begin{aligned} \text{Flying height (H-h)} &= 11,000 \text{ feet} \\ \text{Parallax (P)} &= 4.0 \text{ inches} \\ \text{Photo scale reciprocal (PSR)} &= 11,000 \\ \text{Parallax difference (dp)} &= 0.038 \text{ inch} \\ \text{Distance between points} &= 0.026 \text{ foot} \\ \text{Parallax factor} &= 2.7 \text{ feet per 0.001-inch dp (table 1)} \\ \text{Elevation difference is } &38 \times 2.7 = 103 \text{ feet} \\ \text{Distance between points is } &26 \times 11 = 286 \text{ feet} \\ \text{Slope percent} &= \frac{103}{286} \times 100 = 36.0. \end{aligned}$$

<sup>4</sup> American Society of Photogrammetry. Manual of photographic interpretation. Pp. 154-156, illus. 1960.

<sup>5</sup> Moessner, Karl E., and Earl J. Rogers. Parallax wedge procedures in forest surveys. U.S. Forest Serv. Intermountain Forest and Range Expt. Sta. Misc. Pub. 15, 22 pp., illus. 1957.

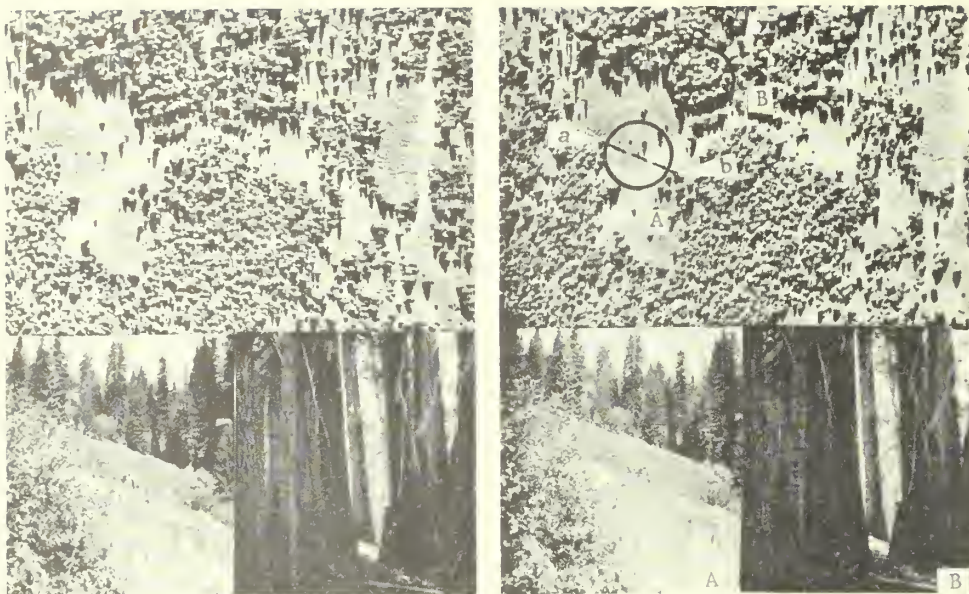

Figure 1.--Slope measurements in open (A) and in wooded area (B). Line a-b is drawn through center of location A in the direction of the steepest slope with ends marked by trees at a and b. The measured parallax difference is 0.038 inch, and the measured length of line is 0.026 foot. This results in a 36-percent slope. At location B the general slope of the ridgetop is measured at 20 percent, but the side slopes are somewhat steeper. Under these conditions field and photo measurements may disagree in direction and therefore in percent of slope.

Where parallax measurements are made for slope only, computations can be speeded up by use of specialized parallax factors (table 2) obtained by dividing the parallax factor (from table 1) by  $\frac{PSR}{1,000}$ . Using the same measurements obtained from figure 1:

$$\begin{aligned} \text{Focal length} &= 12 \text{ inches} \\ \text{Parallax (P)} &= 4 \text{ inches.} \end{aligned}$$

From table 2, the parallax factor is 0.250 foot per 0.001-inch dp:

$$\begin{aligned} \text{Elevation difference} &= 38 \times 0.25 = 9.5 \text{ feet} \\ \text{Distance between points} &= 26 \text{ feet} \\ \text{Slope percent} &= \frac{9.5}{26} \times 100 = 36.5. \end{aligned}$$

The slight difference in results of the two computations is due to rounding of tabular data; both results are very close to the 35 percent measured by Abney level on the ground.

When measurements are made in millimeters by parallax bar, the specialized parallax factors from table 2 are further converted to read in feet per 0.01 millimeter dp (table 3). Otherwise, computations remain the same.

Whenever slopes are measured on aerial photos, the ends of the slope line must be selected, and this involves a certain amount of photo interpretation. When the sample occurs in forest, the interpreter may have difficulty locating the ground. Then it is often more precise to measure points in the open outside the sample if the slope appears the same. In figure 2, location A, the slope might be measured on the cutover area above or to one side of the location (1), or the slope line might be extended from the cutting above (a) through the location to the cutting below (b). Skill in making these decisions can be acquired only through experience.

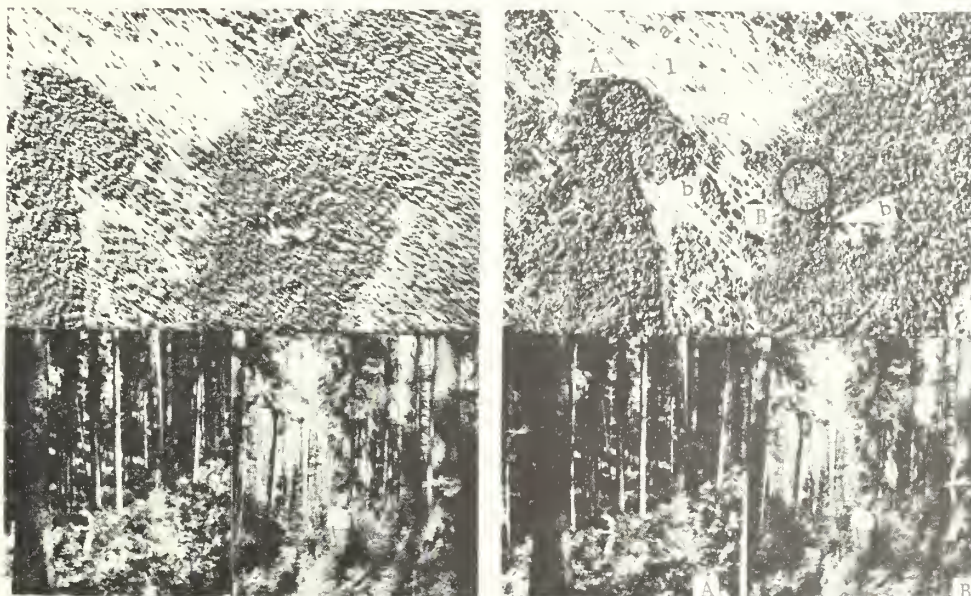

Figure 2. --Slope measurements on forested plots are made between openings wherever possible. Slope at location A, which occurs in the forest, would probably be measured either in the cutover area at point 1, or between points a and b, which lie in the cutover above and below location A, respectively. However, if the forest canopy has no openings, a close approximation of the ground slope could be obtained from measurements made on the treetops near points a and b. Location B would be measured from a to b in the same manner.

Photo data--Flying height (H-h)--11,000 feet  
 PSR--16,000; F.L.-- $8\frac{1}{4}$  inches  
 Parallax (P)--3.6 inches.

Table 1.

Parallax factors by parallax (P) and flying height (H-h)

Parallax: (P) or : (P+dp) (inches):		Flying height (H-h) in thousands of feet																				Parallax (P) or (P+dp) (inches)
		Parallax factor (ho) in feet per 0.001 inch (dp)																				
1.5	1.3	1.7	2.0	2.3	2.7	3.0	3.3	3.7	4.0	4.3	4.7	5.0	5.3	5.6	6.0	6.4	6.7	7.0	1.5			
1.6	1.3	1.6	1.9	2.2	2.5	2.8	3.1	3.4	3.7	4.0	4.3	4.7	5.0	5.3	5.6	6.0	6.3	6.6	1.6			
1.7	1.2	1.5	1.8	2.1	2.3	2.6	2.9	3.2	3.5	3.8	4.1	4.4	4.7	5.0	5.3	5.6	5.9	6.2	1.7			
1.8	1.1	1.4	1.7	2.0	2.2	2.5	2.8	3.0	3.3	3.6	3.9	4.2	4.4	4.7	5.0	5.3	5.5	5.8	1.8			
1.9	1.1	1.3	1.6	1.9	2.1	2.4	2.6	2.9	3.1	3.4	3.7	4.0	4.2	4.5	4.7	5.0	5.2	5.5	1.9			
2.0	1.0	1.2	1.5	1.8	2.0	2.3	2.5	2.7	3.0	3.2	3.5	3.8	4.0	4.2	4.5	4.7	5.0	5.2	2.0			
2.1	1.0	1.2	1.4	1.7	1.9	2.1	2.4	2.6	2.8	3.1	3.3	3.6	3.8	4.0	4.3	4.5	4.8	5.0	2.1			
2.2	0.9	1.1	1.4	1.6	1.8	2.0	2.3	2.5	2.7	2.9	3.2	3.4	3.6	3.9	4.1	4.3	4.5	4.8	2.2			
2.3	0.9	1.1	1.3	1.5	1.7	2.0	2.2	2.4	2.6	2.8	3.0	3.2	3.5	3.7	3.9	4.1	4.3	4.6	2.3			
2.4	0.8	1.0	1.3	1.4	1.7	1.9	2.1	2.3	2.5	2.7	2.9	3.1	3.3	3.5	3.7	4.1	4.4	2.4	2.4			
2.5	0.8	1.0	1.2	1.4	1.6	1.8	2.0	2.2	2.4	2.6	2.8	3.0	3.2	3.4	3.6	3.8	4.0	4.2	2.5			
2.6	0.8	1.0	1.2	1.3	1.5	1.7	1.9	2.1	2.3	2.5	2.7	2.9	3.1	3.3	3.5	3.7	3.8	4.0	2.6			
2.7	0.7	0.9	1.1	1.3	1.5	1.7	1.8	2.0	2.2	2.4	2.6	2.8	3.0	3.2	3.3	3.5	3.7	3.9	2.7			
2.8	0.7	0.9	1.1	1.3	1.4	1.6	1.8	2.0	2.1	2.3	2.5	2.7	2.9	3.0	3.2	3.4	3.6	3.7	2.8			
2.9	0.7	0.9	1.0	1.2	1.4	1.6	1.7	1.9	2.1	2.2	2.4	2.6	2.8	2.9	3.1	3.3	3.4	3.6	2.9			
3.0	0.7	0.8	1.0	1.2	1.3	1.5	1.7	1.8	2.0	2.2	2.3	2.5	2.7	2.8	3.0	3.2	3.3	3.5	3.0			
3.1	0.6	0.8	1.0	1.1	1.3	1.5	1.6	1.8	1.9	2.1	2.2	2.4	2.6	2.7	2.9	3.1	3.2	3.4	3.1			
3.2	0.6	0.8	0.9	1.1	1.2	1.4	1.6	1.7	1.8	2.0	2.2	2.3	2.5	2.7	2.8	3.0	3.1	3.3	3.2			
3.3	0.6	0.8	0.9	1.1	1.2	1.4	1.5	1.7	1.8	2.0	2.1	2.3	2.4	2.6	2.7	2.9	3.0	3.2	3.3			
3.4	0.6	0.7	0.9	1.0	1.2	1.3	1.5	1.6	1.7	1.9	2.1	2.2	2.3	2.5	2.6	2.8	2.9	3.1	3.4			
3.5	0.6	0.7	0.9	1.0	1.1	1.3	1.4	1.6	1.7	1.9	2.0	2.1	2.3	2.4	2.6	2.7	2.8	3.0	3.5			
3.6	0.6	0.7	0.8	1.0	1.1	1.3	1.4	1.5	1.6	1.8	2.0	2.1	2.2	2.4	2.5	2.6	2.8	2.9	3.6			
3.7	0.5	0.7	0.8	0.9	1.1	1.2	1.4	1.5	1.6	1.8	1.9	2.0	2.2	2.3	2.4	2.6	2.7	2.8	3.7			
3.8	0.5	0.7	0.8	0.9	1.1	1.2	1.3	1.4	1.5	1.7	1.8	2.0	2.1	2.2	2.4	2.5	2.6	2.8	3.8			
3.9	0.5	0.6	0.8	0.9	1.0	1.2	1.3	1.4	1.5	1.7	1.8	1.9	2.1	2.2	2.3	2.4	2.6	2.7	3.9			
4.0	0.5	0.6	0.8	0.9	1.0	1.1	1.3	1.4	1.5	1.6	1.7	1.9	2.0	2.1	2.3	2.4	2.5	2.6	4.0			
4.1	0.5	0.6	0.7	0.9	1.0	1.1	1.2	1.3	1.4	1.6	1.7	1.8	2.0	2.1	2.2	2.3	2.4	2.5	4.1			
4.2	0.5	0.6	0.7	0.8	1.0	1.1	1.2	1.3	1.4	1.5	1.7	1.8	1.9	2.0	2.1	2.3	2.4	2.5	4.2			
4.3	0.5	0.6	0.7	0.8	0.9	1.0	1.1	1.3	1.3	1.5	1.6	1.7	1.9	2.0	2.0	2.2	2.3	2.4	4.3			
4.4	0.5	0.6	0.7	0.8	0.9	1.0	1.1	1.2	1.3	1.5	1.6	1.7	1.8	1.9	2.0	2.2	2.3	2.4	4.4			

Flying height (H-h) in thousands of feet

Inches :	11.0 :	11.5 :	12.0 :	12.5 :	13.0 :	13.5 :	14.0 :	14.5 :	15.0 :	15.5 :	16.0 :	16.5 :	17.0 :	17.5 :	18.0 :	18.5 :	19.0 :	19.5 :	Inches
Parallax factor (ho) in feet per 0.001 inch (dp)																			
1.5	7.3	7.7	8.0	8.3	8.7	9.0	9.3	9.7	10.0	10.3	10.7	11.0	11.3	11.6	12.0	12.4	12.7	13.0	1.5
1.6	6.9	7.2	7.5	7.8	8.1	8.5	8.7	9.0	9.4	9.7	10.0	10.3	10.6	11.0	11.2	11.6	11.8	12.2	1.6
1.7	6.5	6.8	7.1	7.3	7.6	7.9	8.2	8.5	8.8	9.1	9.4	9.7	10.0	10.3	10.6	10.8	11.2	11.4	1.7
1.8	6.1	6.4	6.7	6.9	7.2	7.5	7.8	8.1	8.3	8.6	8.9	9.2	9.5	9.7	10.0	10.3	10.6	10.8	1.8
1.9	5.8	6.1	6.3	6.6	6.8	7.1	7.4	7.7	7.9	8.2	8.4	8.7	9.0	9.2	9.5	9.7	10.0	10.2	1.9
2.0	5.5	5.8	6.0	6.3	6.5	6.7	7.0	7.3	7.5	7.8	8.0	8.3	8.5	8.8	9.0	9.3	9.5	9.8	2.0
2.1	5.2	5.5	5.7	5.9	6.2	6.4	6.7	6.9	7.1	7.4	7.6	7.9	8.1	8.3	8.6	8.8	9.0	9.3	2.1
2.2	5.0	5.2	5.5	5.7	5.9	6.1	6.4	6.6	6.8	7.0	7.3	7.5	7.7	7.9	8.2	8.4	8.6	8.9	2.2
2.3	4.8	5.0	5.2	5.4	5.7	5.9	6.1	6.3	6.5	6.7	7.0	7.2	7.4	7.6	7.8	8.0	8.3	8.5	2.3
2.4	4.6	4.8	5.0	5.2	5.4	5.6	5.8	6.0	6.2	6.4	6.7	6.9	7.1	7.3	7.5	7.7	7.9	8.1	2.4
2.5	4.4	4.6	4.8	5.0	5.2	5.4	5.6	5.8	6.0	6.2	6.4	6.6	6.8	7.0	7.2	7.4	7.6	7.8	2.5
2.6	4.2	4.4	4.6	4.8	5.0	5.2	5.4	5.6	5.8	6.0	6.2	6.3	6.5	6.7	6.9	7.1	7.3	7.5	2.6
2.7	4.1	4.3	4.4	4.6	4.8	5.0	5.2	5.4	5.6	5.7	5.9	6.1	6.3	6.5	6.7	6.9	7.0	7.3	2.7
2.8	3.9	4.1	4.3	4.5	4.6	4.8	5.0	5.2	5.4	5.5	5.7	5.9	6.1	6.3	6.4	6.6	6.8	7.0	2.8
2.9	3.8	4.0	4.1	4.3	4.5	4.6	4.8	5.0	5.2	5.3	5.5	5.7	5.9	6.0	6.2	6.4	6.6	6.7	2.9
3.0	3.7	3.8	4.0	4.2	4.3	4.5	4.7	4.9	5.0	5.2	5.3	5.5	5.7	5.8	6.0	6.2	6.3	6.5	3.0
3.1	3.5	3.7	3.9	4.0	4.2	4.3	4.5	4.7	4.8	5.0	5.2	5.3	5.5	5.6	5.8	6.0	6.1	6.3	3.1
3.2	3.4	3.6	3.7	3.9	4.1	4.2	4.4	4.5	4.7	4.8	5.0	5.1	5.3	5.4	5.6	5.8	5.9	6.1	3.2
3.3	3.3	3.5	3.6	3.8	3.9	4.1	4.3	4.4	4.5	4.7	4.8	5.0	5.2	5.3	5.5	5.6	5.7	5.9	3.3
3.4	3.2	3.4	3.5	3.7	3.8	4.0	4.1	4.3	4.4	4.6	4.7	4.8	5.0	5.1	5.3	5.4	5.6	5.7	3.4
3.5	3.1	3.3	3.4	3.6	3.7	3.9	4.0	4.1	4.3	4.4	4.6	4.7	4.9	5.0	5.1	5.3	5.4	5.6	3.5
3.6	3.0	3.2	3.3	3.5	3.6	3.8	3.9	4.0	4.2	4.3	4.4	4.6	4.7	4.9	5.0	5.1	5.3	5.4	3.6
3.7	3.0	3.1	3.2	3.4	3.5	3.7	3.8	3.9	4.0	4.2	4.3	4.5	4.6	4.7	4.9	5.0	5.1	5.3	3.7
3.8	2.9	3.0	3.2	3.3	3.4	3.6	3.7	3.8	3.9	4.1	4.2	4.3	4.5	4.6	4.7	4.9	5.0	5.1	3.8
3.9	2.8	2.9	3.1	3.2	3.3	3.5	3.6	3.7	3.8	4.0	4.1	4.2	4.4	4.5	4.6	4.7	4.9	5.0	3.9
4.0	2.7	2.9	3.0	3.1	3.2	3.4	3.5	3.6	3.7	3.9	4.0	4.1	4.2	4.4	4.5	4.6	4.7	4.9	4.0
4.1	2.7	2.8	2.9	3.0	3.2	3.3	3.4	3.5	3.7	3.8	3.9	4.0	4.1	4.3	4.4	4.5	4.6	4.8	4.1
4.2	2.6	2.7	2.9	3.0	3.1	3.2	3.3	3.5	3.6	3.7	3.8	3.9	4.0	4.2	4.3	4.4	4.5	4.6	4.2
4.3	2.6	2.7	2.8	2.9	3.0	3.1	3.3	3.4	3.5	3.6	3.7	3.8	3.9	4.1	4.2	4.3	4.4	4.5	4.3
4.4	2.5	2.6	2.7	2.8	3.0	3.1	3.2	3.3	3.4	3.5	3.6	3.7	3.9	4.0	4.1	4.2	4.3	4.4	4.4

Table 2. -- Parallax factors by parallax (P) and focal length  
(when measured in inches)

Parallax (P) or (P + dp) (inches)	Focal length of camera lens (inches)			
	6	8	8 $\frac{1}{4}$	12
<u>Parallax factor (ho) in feet per 0.001 inch (dp)</u> <u>divided by PSR/1,000</u>				
2.0	0.250		0.344	0.500
.1	.238		.327	.476
.2	.227		.312	.454
.3	.217		.299	.435
.4	.208		.286	.416
.5	.200		.275	.400
.6	.192		.264	.384
.7	.185		.255	.370
.8	.179		.245	.358
.9	.172		.237	.345
3.0	.167		.229	.333
.1	.161		.222	.322
.2	.156		.215	.312
.3	.151		.208	.303
.4	.147		.202	.294
.5	.143		.196	.286
.6	.139		.191	.278
.7	.135		.186	.270
.8	.132		.181	.263
.9	.128		.176	.256
4.0	.125		.172	.250
.1	.122		.168	.244
.2	.119		.164	.238
.3	.116		.160	.233
.4	.114		.156	.227
.5	.111		.153	.222
.6	.109		.149	.217
.7	.106		.146	.213
.8	.104		.143	.208
.9	.102		.140	.204

Table 3. - -Parallax factors by parallax (P) and focal length  
(when measured in millimeters)

Parallax (P) or (P + dp) (inches)	Focal length of camera lens (inches)			
	6	8 $\frac{1}{4}$	10	12
	Parallax factor (ho) in feet per 0.01 millimeter (dp) divided by PSR/1,000			
2.0	0.098	0.135	0.171	0.197
.1	.094	.129	.167	.187
.2	.089	.123	.161	.179
.3	.085	.118	.156	.171
.4	.082	.113	.151	.164
.5	.079	.108	.146	.157
.6	.076	.104	.141	.151
.7	.073	.100	.136	.146
.8	.070	.097	.131	.141
.9	.068	.093	.126	.136
3.0	.066	.090	.117	.131
.1	.063	.087	.113	.127
.2	.061	.085	.110	.123
.3	.059	.082	.107	.119
.4	.058	.080	.104	.116
.5	.056	.077	.101	.113
.6	.055	.075	.098	.109
.7	.053	.073	.095	.106
.8	.052	.071	.092	.104
.9	.050	.069	.090	.101
4.0	.049	.068	.088	.098
.1	.048	.066	.086	.096
.2	.047	.065	.084	.094
.3	.046	.063	.082	.092
.4	.045	.061	.080	.089
.5	.044	.060	.078	.087
.6	.043	.059	.076	.085
.7	.042	.057	.074	.084
.8	.041	.056	.072	.082
.9	.040	.055	.070	.080



# Research Note

UNITED STATES DEPARTMENT OF AGRICULTURE  
FOREST SERVICE

**INTERMOUNTAIN FOREST & RANGE EXPERIMENT STATION**  
OGDEN UTAH

U.S. Forest Service  
Research Note INT-27

1964

## UTAH'S FOREST AREA AND TIMBER VOLUME

John S. Spencer, Jr., Research Forester  
Division of Forest Economics and Recreation Research

### ABSTRACT

The comprehensive forest inventory of Utah completed in 1961 reports an area of 4 million acres of commercial forest land supporting 5.8 billion cubic feet of wood in sound live trees. The public owns 83 percent of this commercial forest area--principally in National Forests. Aspen, the most extensive commercial timber type, occupies 32 percent of the commercial forest area. Engelmann spruce produces the most saw-timber volume--almost 30 percent of the total for the State.

Utah's forest lands cover 14.9 million acres--28 percent of the land area of the State. Four million acres, or slightly more than one-fourth of the forested area, is commercially important for timber production. The remainder (10.9 million acres) is made up of 10.7 million acres that are incapable of producing trees of commercial size and quality, and 0.2 million acres that are productive but reserved from timber harvesting because they lie within the High Uintas Primitive Area or in National Parks and Monuments.

The public (i.e., Federal and State Government) owns 3.3 million acres of commercial forest land--83 percent of the total. The National Forests account for 83 percent of this publicly owned commercial forest land, followed by State lands (7 percent), Indian lands (5 percent), and lands administered by the Bureau of Land Management (5 percent).

Of the 0.7 million acres of commercial forest land in private holdings, 81 percent is on farms and ranches.

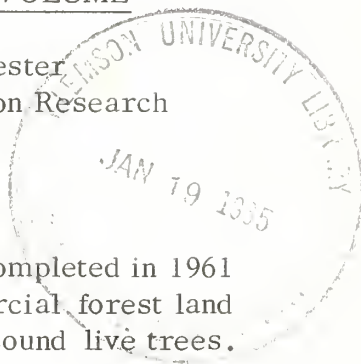

Aspen, the most extensive commercial timber type, occupies 1.3 million acres, or 32 percent of the commercial forest area. The fir-spruce type is next in area with 1.0 million acres (26 percent), followed by Douglas-fir (16 percent), lodgepole pine (14 percent), ponderosa pine (11 percent), and minor types (1 percent).

Sawtimber stands cover two-thirds of the commercial forest land. These stands support a volume of 18.1 billion board feet,<sup>1</sup> for an average volume per acre of 6,904 board feet.

Sawtimber and poletimber stands together occupy 3.8 million acres--94 percent of the commercial forest area. Their combined volumes total 5.8 billion cubic feet in sound live trees 5 inches d.b.h. and larger. Only 6 percent of the commercial forest area is in sapling-seedling stands or is nonstocked. The nonstocked area accounts for only 0.7 percent of the commercial forest land area in Utah.

Engelmann spruce leads all species in sawtimber volume, having almost 30 percent of the total. Aspen leads in growing stock volume (sawtimber and poletimber trees) with 23 percent of the total.

The National Forests grow 82 percent of all sawtimber volume on commercial forest land, while other public lands and private lands each support 9 percent.

The information about forest area and volume reported here is part of the results of the first comprehensive forest inventory of Utah. The timber survey was completed by the joint efforts of the Intermountain Forest and Range Experiment Station and the Intermountain Region of the U.S. Forest Service. Fieldwork began in 1956 and was completed in 1961.

The sampling error for the estimate of total cubic-foot volume on commercial forest land is 2.5 percent or 145,637 M cubic feet. The odds, then, are 2 to 1 that the actual volume in Utah lies in the interval 5,825,460  $\pm$  145,637 M cubic feet.

The following tables show a general preliminary analysis of data from the forest inventory of Utah completed in 1961. A comprehensive analytical report for Utah will be published within the next year.

---

<sup>1</sup> International  $\frac{1}{4}$ -inch log rule.



Table 1.--Area by land classes, Utah, 1961

Land class	Thousand acres
Commercial forest land <sup>1</sup>	3,999
Unproductive forest land <sup>2</sup>	10,701
Productive-reserved forest land <sup>3</sup>	165
Total forest land	14,865
Nonforest land	37,832
All land	<sup>4</sup> 52,697

<sup>1</sup> Forest land that is producing or is capable of producing crops of industrial wood and not withdrawn from timber utilization.

<sup>2</sup> Forest land incapable of growing crops of industrial wood because of adverse site conditions.

<sup>3</sup> Productive forest land withdrawn from timber utilization through statute or administrative regulation.

<sup>4</sup> From U.S. Bureau of the Census, Land and Water Area of the United States, 1960.

Table 2.--Area of commercial forest land, by ownership classes, Utah, 1961

Ownership class	Thousand acres
National Forest	2,783
Other Federal:	
Bureau of Land Management	155
Indian	158
Total other Federal	313
State	240
Farmer-owned	540
Other private	123
All ownerships	3,999

Table 3.--Area of commercial forest land, by stand-size and ownership classes, Utah, 1961

Stand-size class	All ownerships	National Forest	Other public	Farmer and other private
Thousand acres				
Sawtimber stands <sup>1</sup>	2,629	1,857	379	393
Poletimber stands <sup>2</sup>	1,125	840	103	182
Sapling and seedling stands <sup>3</sup>	218	80	61	77
Nonstocked areas <sup>4</sup>	27	6	10	11
All classes	3,999	2,783	553	663

<sup>1</sup> Stands at least 10-percent stocked with growing stock trees with a minimum net volume per acre of 1,500 board feet (International  $\frac{1}{4}$ -inch log rule) in sawtimber trees (11.0 inches d.b.h. and larger).

<sup>2</sup> Stands failing to meet the sawtimber stand specifications, but at least 10-percent stocked with poletimber and larger (5.0 inches d.b.h. and larger) trees and with at least half the minimum stocking in poletimber trees.

<sup>3</sup> A stand not qualifying as either a sawtimber or poletimber stand, but having at least 10-percent stocking of trees of commercial species and with at least half the stocking in sapling and seedling trees (less than 5.0 inches d.b.h.).

<sup>4</sup> An area not qualifying as a sawtimber, poletimber, or a sapling-seedling stand; i.e., normally an area less than 10-percent stocked.

Table 4.--Area of commercial forest land, by forest types and ownership classes, Utah, 1961

Forest type	All	Public	Private
	ownerships	ownerships	ownerships
-----Thousand acres-----			
Douglas-fir	646	507	139
Ponderosa pine	432	400	32
Lodgepole pine	563	531	32
Whitebark and limber pine	29	18	11
Fir-spruce	1,047	963	84
Aspen	1,280	915	365
Cottonwood	2	2	--
All types	3,999	3,336	663

Table 5.--Volume of growing stock and sawtimber on commercial forest land by species, Utah, 1961

Species	Growing stock <sup>1</sup>	Sawtimber
	M cubic feet	M board feet <sup>2</sup>
Softwoods:		
Douglas-fir	898,970	3,851,497
Ponderosa pine	433,493	1,942,891
Lodgepole pine	970,600	2,529,974
Whitebark and limber pine	57,439	220,812
White fir	313,301	1,337,666
Subalpine fir	598,927	1,709,599
Engelmann spruce	1,217,191	5,799,730
Total	4,489,921	17,392,169
Hardwoods:		
Aspen	1,333,279	2,117,183
Cottonwood	2,260	11,212
Total	1,335,539	2,128,395
All species	5,825,460	19,520,564

<sup>1</sup>Growing stock volume. Net volume in cubic feet of live merchantable sawtimber trees and poletimber trees from stump to a minimum 4.0-inch top inside bark.

<sup>2</sup>International 1/4-inch log rule.

Table 6.--Volume of growing stock and sawtimber on commercial forest land by ownership classes, Utah, 1961

Ownership class	Growing stock	Sawtimber
	M cubic feet	M board feet <sup>1</sup>
National Forest	4,634,804	15,950,561
Other public	568,365	1,843,343
Private	622,291	1,726,660
All classes	5,825,460	19,520,564

<sup>1</sup>International 1/4-inch log rule.

Table 7.--Volume of growing stock and sawtimber on commercial forest land by stand-size classes, Utah, 1961

Stand-size class	Growing stock	Sawtimber
	M cubic feet	M board feet <sup>1</sup>
Sawtimber stands	4,664,741	18,149,614
Poletimber stands	1,133,760	1,345,692
Sapling and seedling stands	26,480	23,365
Nonstocked areas	479	1,893
All classes	5,825,460	19,520,564

<sup>1</sup>International 1/4-inch log rule.



# Research Note

UNITED STATES DEPARTMENT OF AGRICULTURE  
FOREST SERVICE

INTERMOUNTAIN FOREST & RANGE EXPERIMENT STATION  
OGDEN UTAH

J.S. Forest Service  
Research Note INT-28

1964

## PROBABLE RETURN PERIODS OF RAINSTORMS IN CENTRAL IDAHO

W. Joe Kidd, Jr.<sup>1</sup>

Division of Watershed Management Research

### ABSTRACT

Analyses of data recorded for 229 rainstorms in the mountains of central Idaho yielded information from which "probable period of return" curves were developed for storms of varied volumes, durations, and intensities.

This paper presents results of detailed analyses of data recorded for 229 rainstorms<sup>2</sup> during the 5-year period 1959-1963 on the Zena Creek sale area of the Payette National Forest. The figures and tables will be useful to logging and road engineers, watershed managers, forest soil surveyors, and meteorologists working in the mountainous areas of the Payette and Boise National Forests.

The Zena Creek sale area (approximately 9,000 acres) typifies the rugged topography dissected by numerous high gradient, V-bottomed streams common in central Idaho. Elevations range from 3,800 to 7,000 feet above mean sea level. A rain gage network was started in 1959 within the sale area with three recording rain gages. The network now consists of seven rain gages: two are at an elevation of 4,200 feet, four are at 5,000 feet, and one is at 6,400 feet.

<sup>1</sup> Research forester, Intermountain Forest and Range Experiment Station, Boise, Idaho.

<sup>2</sup> A "storm" is defined as a period of rainfall separated by at least 6 hours from any other period in which rain falls.

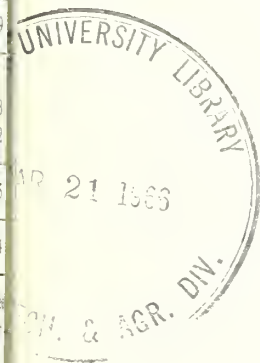

Rainstorms during the period April 1 to October 31 produce about 45 percent of the average annual precipitation of 28.74 inches. The remaining 55 percent falls mainly as snow, but at lower elevations rain may fall in March and early November.

Data recorded for each rainstorm include total amount, duration, and maximum rates of rainfall for specified periods. This information was the basis for computing the probable "period of return" for storms of various amounts, durations, and intensities. Probability computations were made by the method described by Conrad and Pollak,<sup>3</sup> and were then converted to a return period in years at the 50-percent reliability level. This level of reliability means that a described event has an even chance of occurring within the computed period of time. Higher levels of reliability are more appropriate only when considering construction of such costly structures as large bridges or dams.

Figure 1 shows the probable return period in years (at the 50-percent level of reliability) of storms yielding from 0.1 to 6.5 inches of rain. Example: there is an even chance that a 5-inch rainstorm will occur once every 23 years.

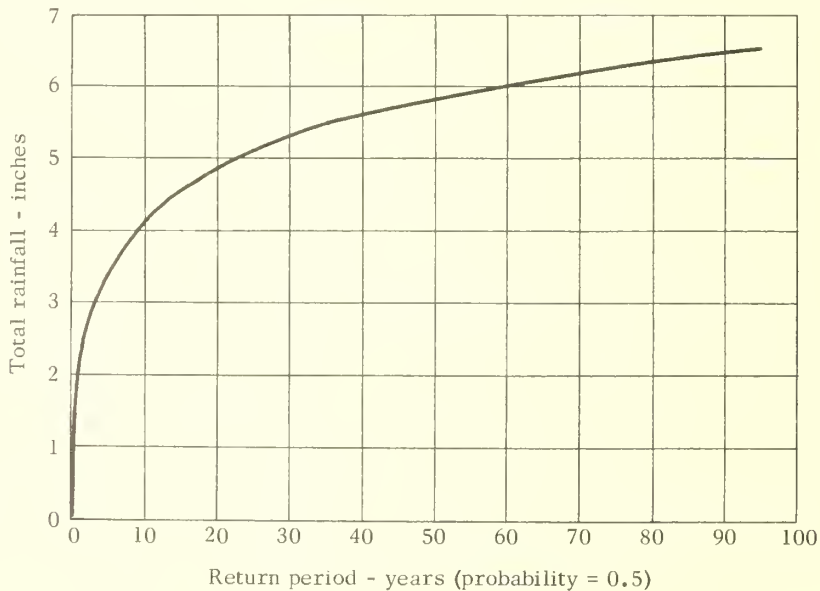

Figure 1.--Probable return period in years ( $p = 0.5$ ) for rainstorms of different magnitude.

<sup>3</sup> Conrad, V., and L. W. Pollak. Methods of climatology. Ed. 2, pp. 208-211. Cambridge: Harvard Univ. Press. 1950.

Figure 2 is the curve for the probable return period in years (at the 50-percent reliability level) of rainstorms that may continue for as long as 120 hours. The curve shows an even chance that a 72-hour rainstorm can be expected once every 5 years.

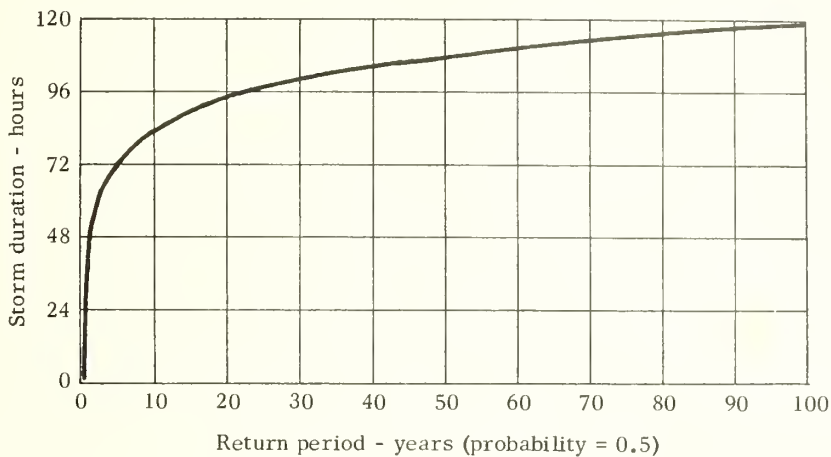

Figure 2. -- Probable return period in years ( $p = 0.5$ ) for rainstorms of different durations.

Figure 3 is based on the maximum 15-minute intensity for each recorded storm. High intensity bursts of rainfall seldom persist longer than 15 minutes in the central Idaho mountains. This curve shows a reasonable certainty that a storm of 3-inches-per-hour intensity will occur once every 4 years.

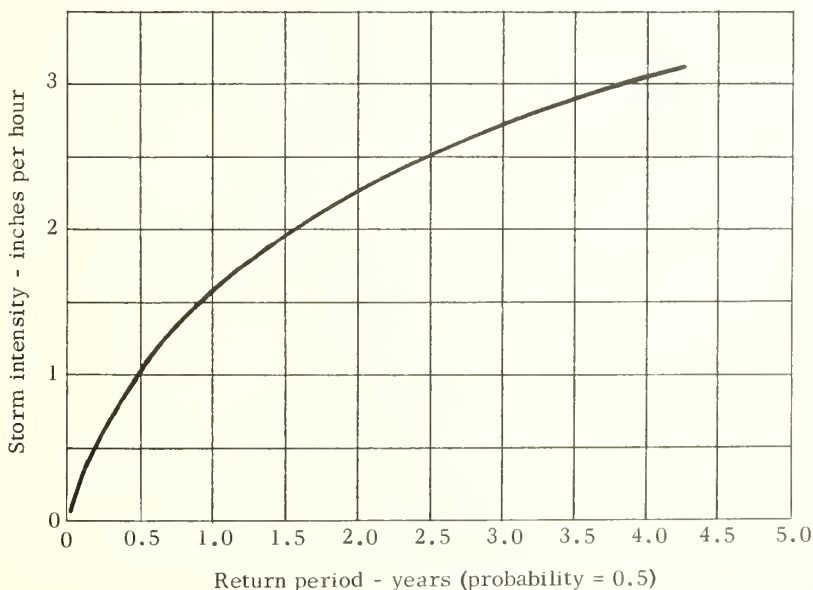

Figure 3. -- Probable return period in years ( $p = 0.5$ ) for rainstorms of different intensities. (Basis: maximum 15-minute intensity during each storm.)

Figure 4 is based on the maximum rainfall intensity for any length of time from 1 minute to 15 minutes during a storm. This curve shows an even chance that rainstorms of 6-inches-per-hour intensity may occur once every 34 years. However, the 6-inches-per-hour rate may apply only to a 5-minute burst of rainfall during an entire storm.

Figure 4.--Probable return period in years ( $p = 0.5$ ) for storms of different intensities. (Basis: maximum rainfall intensities during any time interval.)

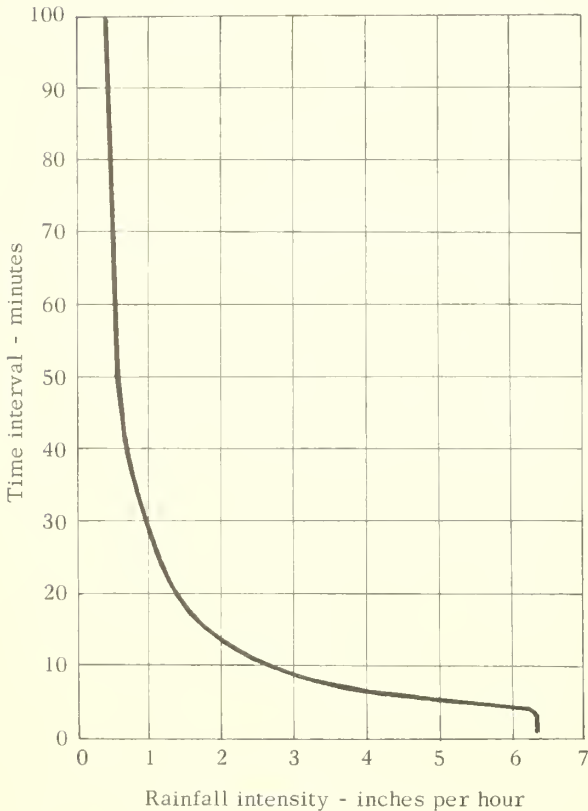
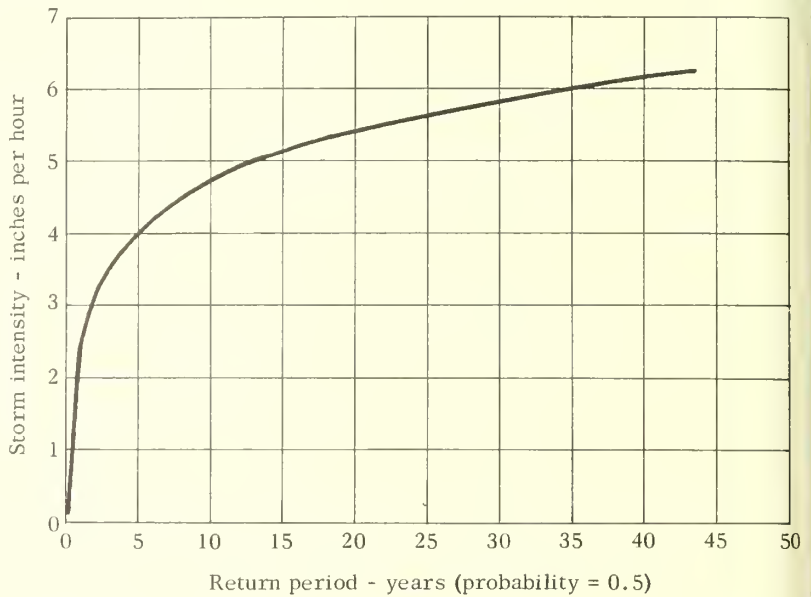
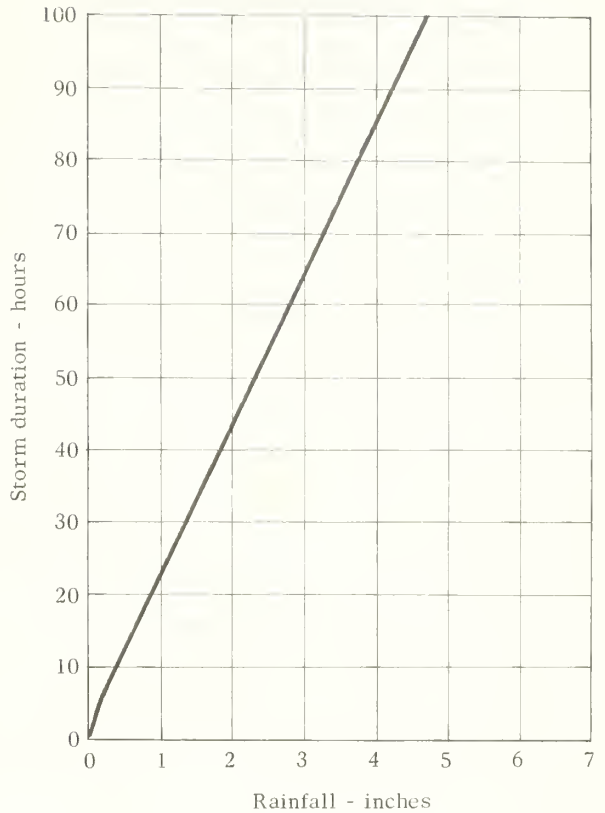

Figure 5 shows the maximum recorded rainfall intensities in inches per hour for time periods ranging from 1 to 100 minutes. For example, the maximum 10-minute intensity recorded to date is 2.67 inches per hour.

Figure 5.--Maximum recorded rainfall intensities (inches per hour) for various time intervals.

Figure 6 shows the average rainfall for storms of different durations during the period 1959-1963. For instance, the average rainfall of storms lasting 23 hours totals 1 inch; but the average yield of storms lasting 75 hours is 3.5 inches.

Figure 6.--Average rainfall per storm for storms of different durations.



Tables 1 through 4 show the number of storms recorded per month by rainfall depth, duration, and intensity classes for the 5-year period 1959-1963. The data contained in these tables formed the basis for computing the probable return periods depicted in figures 1 to 4.

Table 1.--Storms per month classed by rainfall depth (1959-1963)

Rain depth (inches)	Mar.	Apr.	May	June	July	Aug.	Sept.	Oct.	Nov.	Total
-----Number-----										
0.01-0.05	0	3	10	3	5	5	11	2	1	40
0.06-0.10	0	6	12	7	3	5	6	6	1	46
0.11-0.25	1	8	17	15	2	7	5	4	0	59
0.26-0.50	3	3	12	6	3	8	11	2	1	49
0.51-1.00	1	2	6	4	0	2	5	4	2	26
1.01+	1	1	3	2	0	0	0	2	0	9
Total	6	23	60	37	13	27	38	20	5	229

Table 2.--Storms per month classed by duration (1959-1963)

Storm duration (hrs.:min.)	Mar.	Apr.	May	June	July	Aug.	Sept.	Oct.	Nov.	Total
-----Number-----										
0:01- 0:15	0	1	2	2	1	3	5	0	0	14
0:16- 0:30	0	1	4	2	1	3	2	0	0	13
0:31- 1:00	0	1	4	4	2	1	1	0	1	14
1:01- 6:00	0	11	19	16	7	10	14	8	1	86
6:01-12:00	1	6	19	5	1	7	8	6	1	54
12:01-18:00	2	1	6	7	1	2	4	1	1	25
18:01-24:00	1	0	1	0	0	0	2	1	1	6
24:01-48:00	2	2	5	1	0	1	2	3	0	16
48:01+	0	0	0	0	0	0	0	1	0	1
Total	6	23	60	37	13	27	38	20	5	229



Table 3.--Storms per month classed by maximum 15-minute intensity (1959-1963)

Intensity (in./hr.)	Mar.	Apr.	May	June	July	Aug.	Sept.	Oct.	Nov.	Total
	----- <u>Number</u> -----									
0.01-0.25	4	19	47	26	9	16	25	18	4	168
0.26-0.50	2	1	12	7	3	4	7	0	1	37
0.51-0.75	0	0	1	1	0	2	3	0	0	7
0.76-1.00	0	1	0	1	1	1	0	0	0	4
1.01-1.25	0	0	0	0	0	3	2	0	0	5
1.26-1.50	0	0	0	1	0	0	0	0	0	1
Total	6	21	60	36	13	26	37	18	5	<sup>1</sup> 222

<sup>1</sup>Seven of the 229 storms lasted less than 15 minutes.

Table 4.--Storms per month classed by intensity (maximum for any time interval)  
1959-1963

Intensity (in./hr.)	Mar.	Apr.	May	June	July	Aug.	Sept.	Oct.	Nov.	Total
	----- <u>Number</u> -----									
0.01-0.25	3	15	42	18	6	14	21	12	4	135
0.26-0.50	2	2	12	8	3	3	4	5	1	40
0.51-0.75	0	2	4	4	2	1	4	1	--	18
0.76-1.00	0	2	0	1	1	3	3	--	--	10
1.01-1.25	0	0	0	0	0	1	1	--	--	2
1.26-1.50	0	0	2	2	0	1	0	--	--	5
1.51-2.00	0	1	--	0	0	3	0	--	--	4
2.01-3.00	1	--	--	2	1	1	3	--	--	8
3.01-4.00				1			2			3
4.01-5.00				0						0
5.01-6.00				0						0
6.01+				1						1
Total	6	22	60	37	13	27	38	18	5	<sup>1</sup> 226

<sup>1</sup>Three of the 229 storms had intensities less than 0.01 inch/hour.

Although the probability curves are based on data for only 5 years, they are being published now because this information is needed. More accurate results can be obtained only from analysis of long-term records of rainfall. Additional data will be gathered during ensuing years and may later provide refinement for the tables and graphs above.



# Research Note

UNITED STATES DEPARTMENT OF AGRICULTURE  
FOREST SERVICE

**INTERMOUNTAIN FOREST & RANGE EXPERIMENT STATION**  
OGDEN UTAH

U.S. Forest Service  
Research Note INT-29

1964

INITIAL GERMINATION AND SURVIVAL OF LODGEPOLE PINE  
ON PREPARED SEEDBEDS

by

James E. Lotan<sup>1</sup>

Division of Forest Disease and Timber Management Research

ABSTRACT

Nine methods of seedbed preparation were tested on the Gallatin and Targhee National Forests to determine which method provided best conditions for germination and survival of lodgepole pine. Thorough preparation of seedbed, directed towards conserving soil moisture, considerably improved both germination and survival.

Adequate natural regeneration of lodgepole pine (*Pinus contorta* Dougl.) is usually obtained in Rocky Mountain stands by careful handling of logging slash bearing serotinous cones.<sup>2,3</sup> Despite this precaution, clearcuttings in parts of southwestern Montana and eastern Idaho have not regenerated adequately. Furthermore, when the methods used to regenerate lodgepole pine in central Montana are successful, they often produce a superabundance of seedlings. Noncommercial thinnings are then needed to prevent the young stands from stagnating. These facts pointed out a need for new information on effects of various methods of seedbed preparation on germination and survival of lodgepole pine. When conditions affecting germination and survival are better understood, then treatments can be recommended that will not only increase success of seedling establishment but also will reduce overstocking.

<sup>1</sup> Research forester, Intermountain Forest and Range Experiment Station, Forest Service, U.S. Department of Agriculture; at Forestry Sciences Laboratory, Bozeman, Montana, maintained in cooperation with Montana State College.

<sup>2</sup> Boe, K. N. Regeneration and slash disposal in lodgepole pine clear cuttings. Northwest Sci. 30(1): 1-11, illus. 1956.

<sup>3</sup> Tackle, David. Regenerating lodgepole pine in central Montana following clear cutting. U.S. Forest Serv. Res. Note INT-17, 7 pp., illus. 1964.

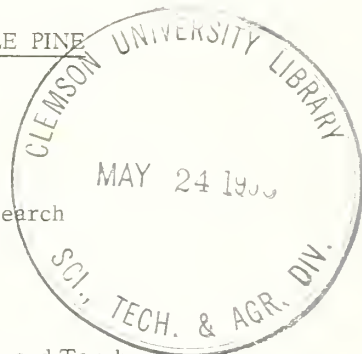

Nine methods of seedbed preparation were tested on three physiographic areas where adequate regeneration of lodgepole pine has been difficult to obtain on the Gallatin National Forest near West Yellowstone, Montana, and the Targhee National Forest near Island Park, Idaho. Plots were sown with treated lodgepole pine seed. Weekly and biweekly seedling counts were made on 2-milacre plots, testing nine prepared seedbeds at each replication. This paper presents the results obtained during the first growing season.

## METHODS

### Experimental Design and Study Areas

Nine seedbed treatments were replicated three times in a randomized block design on each of three physiographic areas (table 1).

Table 1.--Location and characteristics of experimental areas

Area and National Forest	Soil type	Slope	Elevation	Year logged	Year slash treated
		<u>Percent</u>	<u>Feet</u>		
West Yellowstone, Gallatin N. F.	Alluvial obsidian sands and gravel	<5	6,700	1957	1958
Island Park, Targhee N. F.	Alluvial rhyolitic loam over cobble	5 to 15	6,500	1959	1960
Moose Creek Plateau, Targhee N. F.	Gravelly clay loam developed from various volcanic rocks	5 to 15	7,800	1961	1961

### Treatments

Rectangular 2-milacre plots (6.6 × 13.2 feet), oriented with their long axes in a north-south direction, were treated during the summer of 1961 as follows:

1. Check. Natural undisturbed duff.
2. Burned. Areas where slash had been piled and burned.
3. Disked. Plots were disked in an east-west direction by a lightweight disk harrow.
4. Scalped. Area was stripped of all vegetation by using a shovel to simulate scalping by a dozer blade.
5. Scalped and cultivated. Area was stripped of all vegetation and the soil was loosened to a depth of 6 inches by using a shovel.
6. Scalped, cultivated, and sprayed. Area was treated as in treatment 5 and in addition was sprayed with dalapon grass killer (2,2-dichloropropionic acid) at a rate of 16 pounds per acre.
7. Simulated brushblade scarification. Quadrat was partially scalped (about 90 percent of the area) of vegetation, and small trenches (about 16 inches apart and 1 to 3 inches deep) were dug with a mattock in an east-west direction.

8. Furrowed. Trenches 3 to 4 inches deep were dug in an east-west direction leaving a sharp, perpendicular edge to the south to provide maximum shade to seedlings in the trench.

9. V-shape trenched. Trenches 3 to 4 inches deep were dug in an east-west direction leaving a 45-degree angle to both the north and south to provide seedlings with minimal shade.

### Seeding

The lodgepole pine seed used in this study were collected on the Targhee National Forest in 1958 at an elevation of 6,300 feet. Seed were 55-percent viable (standard germination test) and were treated with 17.5 percent anthraquinone and 2.5 percent Endrin (clean, untreated seed basis) to repel birds and rodents. The seed were sown in October 1961. A large amount of seed (2,200 viable seed per milacre) was used to insure an adequate seedling catch and thereby permit statistical analysis of data from all treatments. Failure on adverse seedbeds would have hindered analysis of data.

### Measurements

Seedling counts were made weekly during the early part of the season and biweekly after both germination and mortality declined. Mortality was recorded by numbers of seedlings, week of germination (colored toothpicks beside seedlings denoted week of germination), and apparent cause of mortality. Seedling counts were made on the central milacre ( $4.4 \times 9.9$  feet) of the 2-milacre plot to avoid an "edge" effect and to provide an area for sampling soil moisture. Soil moisture was determined six times during the season at 2-inch intervals to the 6-inch depth and at 6-inch intervals to the 18-inch depth.

A weather station was located at one replication on each physiographic area and was equipped with a recording rain gage, hygrothermograph, soil thermograph, maximum and minimum thermometers, and a totalizing anemometer. Weather data were recorded at weekly intervals. Maximum soil surface temperatures were measured on each plot using both Tempils<sup>o</sup> and a thermograph at each weather station. The soil thermograph was calibrated using a potentiometric pyrometer.

## RESULTS

### Germination

Although more than 90 percent of the seedlings had germinated by early July (figs. 1 and 2), some germination continued throughout the remainder of the summer. However, late season germination only partially offset mortality; it did not add appreciably to the final count of seedlings in September. Less than 2 percent of the total germination occurred during each examination period after the middle of July.

On the Moose Creek Plateau, 91 percent of the seedlings germinated within a 2-week period (fig. 2). The plots were examined carefully on June 27, but no seedlings were present; in fact, some plots still had snow on them (in the previous week 1 to 2 feet of snow covered the entire area). On July 5, 1 week later, 74 percent of the seedlings had germinated. By July 11 the peak of germination had passed; only 2 percent germinated during the third week of the observation period. Apparently, as soon as the snow cover left, conditions were favorable for immediate germination on this high area.

Germination on the two lower areas (West Yellowstone and Island Park) did not occur as rapidly as at Moose Creek Plateau. Unfortunately, seedling counts were not made soon enough to determine the start of germination on these two areas. However, general observations and air temperature records indicate that peak germination probably occurred during the last 2 weeks in June. Bates<sup>4</sup> stated that the optimum basic temperature for lodgepole pine germination is about 70° F. (21° C.). Air temperatures reached 70° F. on these study areas about the middle of June, following snowmelt during the early part of May.

---

<sup>4</sup>Bates, C. G. The production, extraction, and germination of lodgepole pine seed. U.S. Dept. Agr. Tech. Bull. 191, 192 pp., illus. 1930.

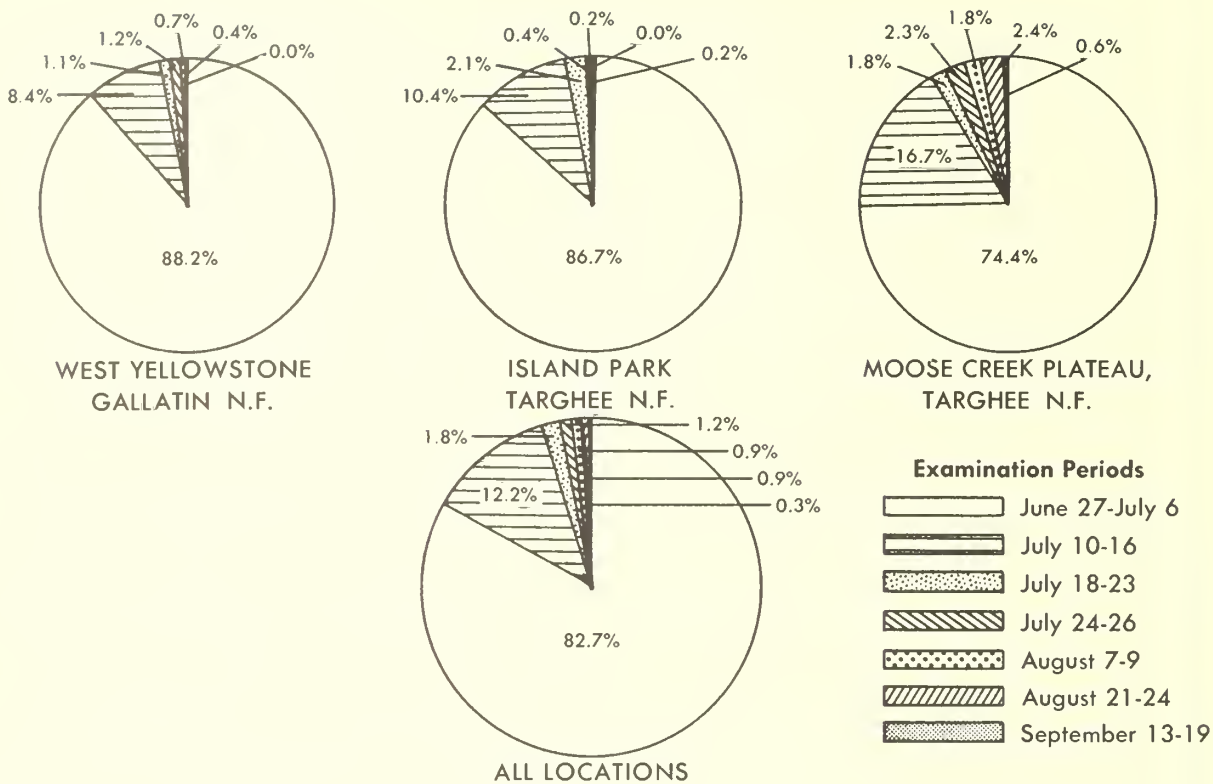

Figure 1. --Germination by date and area, Gallatin and Targhee National Forests, 1962.

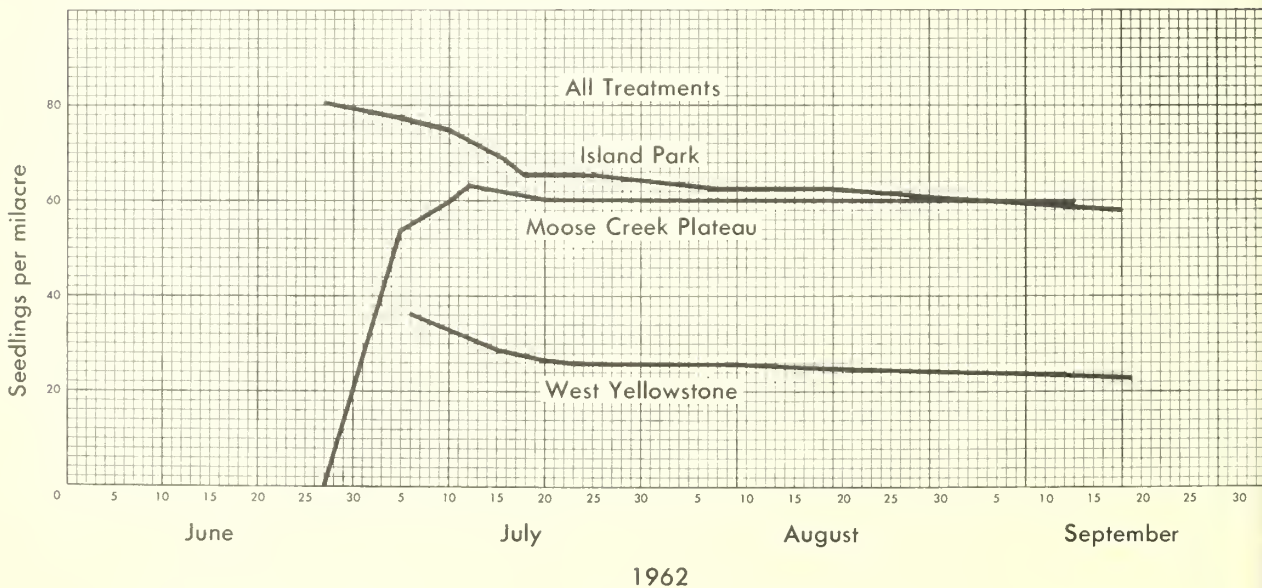

Figure 2. --Average number of seedlings per milacre from all treatments, by area, Gallatin and Targhee National Forests, 1962.

## Mortality

As with germination, mortality occurred early in the season (fig. 3). Only traces of precipitation fell between June 22 and July 13, when most of the mortality occurred. More than an inch of rain fell during a timely storm that began on July 13. On the two lower sites, more than 70 percent of the mortality occurred by the middle of July (fig. 3). On the Moose Creek Plateau approximately half of the mortality occurred during the first 2 to 3 weeks after germination began.

Approximately 90 percent of the mortality was attributed to drought. Seedlings recorded as "drought mortality" were shriveled and dry without sign of mechanical injury. Most were upright and brown in color. Some were blown to one side and broken because of the brittleness of their stems. Other agents were gophers, birds, soil movement, heat injury, and hail. Unknown factors accounted for 7 percent of the losses.

Heat injury, or stem necrosis by insolation, did not occur as frequently as had been expected. Soil surface temperatures commonly exceeded 138° F. (59° C.) for several hours on all seedbeds, and temperatures from 150° to 163° F. (65° to 75° C.) were observed occasionally on surfaces of the check and burned treatments.

Survival was not correlated with age of seedling, as had been expected; i. e., late germinating seedlings did not necessarily succumb more readily than early germinating seedlings. The correlation coefficient for percentage of survival over age of seedlings was only 0.064.

Late in the season, mortality increased slightly (fig. 3). Following cessation of heavy rains during the middle and latter part of July, soil moisture declined rapidly. Rainfall during late August and early September was light, and daytime temperatures remained relatively high. Although root growth was not studied in detail, excavations of a few seedlings less than 8 weeks old on August 2 showed that roots on the trenched and scalped treatments had grown 5 to 6 inches, compared with about 4 inches on the check plots. Apparently, near the end of the season root growth was not sufficient to maintain some seedlings through the dry period, when even the 12- to 18-inch depth was affected.

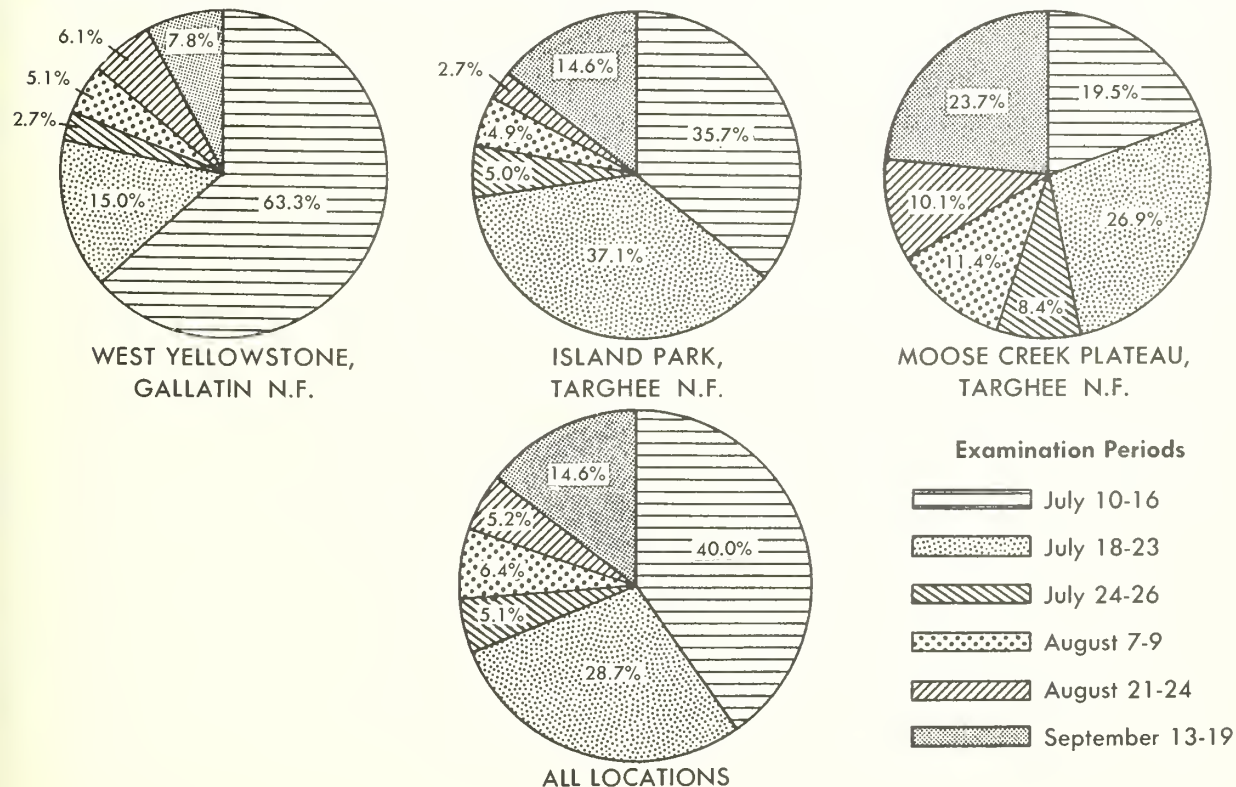

Figure 3.--Seedling mortality by date and area, Gallatin and Targhee National Forests, 1962

## Survival

The number of seedlings per milacre surviving the first growing season was significantly greater on each of four thoroughly prepared seedbeds than on the check treatment (table 2). Three of the four most successful treatments had some form of east-west-oriented trenching. The furrowed, V-shape trenched, and simulated brushblade treatments were all more effective than other treatments; the deeper trenches provided the best environment.

The amount of seed used in this study was large enough to insure that some seedlings would survive even the more adverse treatments. In table 2, to make the results more meaningful to forest managers, the numbers of seedlings per milacre have been converted to ratios of viable seed/seedlings based on September counts of survival. For example, 278 viable seed were required to establish one seedling on the burned treatment, compared with only 26 seed on the furrowed treatment.

Table 2.--Average number of seedlings per milacre and seed/seedling ratios by treatment and area,  
Gallatin and Targhee National Forests, September 1962

Seedbed treatments	West Yellowstone	Island Park	Moose Creek Plateau	All locations	Viable seed/seedling ratio
----- Number -----					
Burned	14.7	5.0	4.0	7.9	278
Check	6.0	16.7	3.0	8.5	259
Disked	3.3	27.3	44.7	25.1	88
Scalped	11.3	74.7	15.0	33.7	65
Sprayed	17.0	68.3	52.7	46.0	48
Cultivated	21.7	72.3	105.0	66.3	33
Brushblade	19.7	100.3	79.3	66.4	33
V-shape trenched	67.0	78.0	98.7	81.2	27
Furrowed	48.3	81.3	118.7	82.8	26

<sup>1</sup> Any two means of the "All locations" column not included in the same vertical bracket are significantly different at the 95-percent level of probability.

Treatments that provided best conditions for production of maximum number of established seedlings by September were not necessarily the best treatments for survival. For production of a maximum number of established seedlings by September, a treatment had to provide an environment at once favorable to germination in the spring and also favorable to survival during harsh climatic conditions in summer. The "sprayed" treatment ranked high in terms of percentage survival (table 3), but did not rank as high in terms of established seedlings per milacre in September (table 2), presumably because initial germination was low. No significant differences in survival occurred among any of the trenching-type treatments or the scalping-type treatments (table 3). Trenching apparently provided better conditions for germination than scalping, but did not increase survival.



Table 3.--Percentage survival<sup>1</sup> of total germinates by treatment and area, Gallatin and Targhee National Forests, September 1962

Seedbed treatments	West Yellowstone	Island Park	Moose Creek Plateau	All locations
----- Percent -----				
Check	19.3	29.7	43.4	30.8
Burned	39.4	17.6	54.6	37.2
Disked	15.9	46.7	74.7	45.7
Brushblade	18.9	72.9	77.2	56.3
Scalped	39.1	64.5	70.9	58.2
Furrowed	52.8	59.8	83.9	65.5
V-shape trenched	81.9	62.8	74.6	73.1
Sprayed	64.6	88.1	83.9	78.9
Cultivated	88.8	79.7	85.6	84.7

<sup>1</sup>Percentages were transformed to arcsin  $\sqrt{\text{percentage}}$  for statistical analysis.

<sup>2</sup>Any two means of the "All locations" column not included in the same vertical bracket are significantly different at the 95-percent level of probability.

#### DISCUSSION AND CONCLUSIONS

The first growing season of the study (1962) was relatively cool and wet.<sup>5</sup> At West Yellowstone the maximum recorded temperature in 1962 was 86° F. (30° C.) compared with 96° F. (36° C.) in 1961 and a 91° F. (33° C.) average recorded maximum for the previous 12 years. Precipitation in July and August was 4.36 inches compared with a 30-year average of 2.44 inches. More than 60 percent of this additional moisture fell during the storm on July 13 at a very critical time. Mortality declined rapidly following this rain, and roots grew to a depth where even later in the season soil moisture was adequate for survival of most seedlings. If there had been no rain during this critical period, differences among seedbed treatments could have been greater. A relatively hot, dry season (such as 1961) would have shown greater differences in survival, and probably would have killed more late germinates.

Differences in survival of seedlings in furrows and in V-shaped trenches were not significant; therefore, the expected effect of shading in the furrowed treatment did not materialize. In both treatments, soil settled and reduced the expected difference in survival, particularly in the sandy soil at West Yellowstone. The advantages of trenching were probably twofold: (1) it aided in collecting water and concentrating it, and (2) it protected the seedlings from the hot, dry southwest wind blowing off the Snake River valley. These winds are frequent during the summer at all three study areas. Most seedlings germinated in the bottom of the trenches; those that germinated on the ridges did not survive.

Even though soil surface temperatures reached 150° to 163° F. (65° to 75° C.), direct heat injury to the seedlings proved to be less important than had been expected. Meyer and Anderson<sup>6</sup> had suggested 50° to 60° C. as the thermal death point for most living plant cells. However, soil surface temperatures are not only elusive to measure, but many factors influence minimum lethal temperatures and exposure times.

<sup>5</sup> U.S. Weather Bureau. Climatological data for the United States by sections. Montana section, vols. 53-65, 1950-1962.

<sup>6</sup> Meyer, B. S., and Anderson, D. B. Plant physiology. Princeton, N.J.: D. Van Nostrand Co., Inc. 784 pp., illus. 1952.

Day<sup>7</sup> made an excellent review of literature on this subject. Variation in soil moisture, relative humidity near the seedlings, color of surface material, shading by vegetation, and microslope are some of the more important factors affecting soil surface temperatures. Furthermore, the condition of the protoplasm and internal water relations affect the temperature at which tissue necrosis occurs. The full importance of heat injury as a cause of mortality during hot, dry years on these three physiographic areas will have to be determined by future work.

Although the study was conducted in what appears to have been a favorable year, first-year results permit the following conclusions:

1. Thorough preparation of the seedbed greatly improves germination and survival of lodgepole pine in southwestern Montana and eastern Idaho. The better treatments should provide conditions that will enable survival of one seedling for every 30 to 50 viable seed, whether sown or from a natural supply; i.e., from 30,000 to 50,000 viable seed per acre ought to establish a September catch of 1,000 seedlings per acre.

2. More than 90 percent of the lodgepole pine seedlings germinate early in the season (in a period of 2 to 4 weeks) once conditions become favorable. However, in the Rocky Mountains conditions do not favor germination until late June or early July.

3. A principal cause of first-year seedling mortality in lodgepole pine is drought, even in a relatively cool, wet summer. Therefore, seedbed treatment for optimum lodgepole pine regeneration in southwestern Montana and eastern Idaho should be directed towards conserving soil moisture.

---

<sup>7</sup>Day, R. J. Spruce seedling mortality caused by adverse summer microclimate in the Rocky Mountains. Canada Dept. Forestry Pub. 1003, 35 pp., illus. 1963.



# Research Note

UNITED STATES DEPARTMENT OF AGRICULTURE  
FOREST SERVICE

INTERMOUNTAIN FOREST & RANGE EXPERIMENT STATION  
OGDEN UTAH

U.S. Forest Service  
Research Note INT-30

1965

## EFFECT OF WATER ON THE CONCENTRATION OF CYCLOHEXIMIDE IN FUEL OIL

W. T. Collins and J. W. Koenigs<sup>1</sup>  
Division of Forest Disease and Timber Management Research

### ABSTRACT

Water removes cycloheximide from oil solvent, but the degree of removal could not be determined because neither the oil nor the water fraction containing cycloheximide could be bioassayed directly.

### INTRODUCTION

The poor results sometimes obtained when treating western white pine trees with the antibiotic cycloheximide to control blister rust have been attributed to two physical factors:<sup>2</sup>

1. Incompatibility of cycloheximide with some brands of oil.

This problem has been solved.

2. Affinity of cycloheximide for water.

It was suggested that water in equipment used for spraying the oil solution of cycloheximide extracts enough of the antibiotic from the oil to seriously lower the dosage of the antibiotic applied to trees.

<sup>1</sup> Plant Physiologist and Plant Pathologist, respectively, Forestry Sciences Laboratory, Intermountain Forest and Range Experiment Station, Forest Service, U.S. Department of Agriculture, Moscow, Idaho.

<sup>2</sup> Moss, V. D., T. R. Peterson, and W. E. Bousfield. Antibiotic development and improvement work. IN: White Pine Blister Rust Control, Calendar Year 1960. U.S. Dept. Agr., Forest Service, Region One, Missoula, Mont., pp. 38-49. 1961.

Therefore it seemed desirable to determine how much cycloheximide is thus removed from the oil so that enough antibiotic might be added to compensate for this loss.

## METHODS

Cycloheximide was first dissolved in 10 ml. of acetone. This cycloheximide solution was added to No. 1 stove oil containing 0.2 percent Triton 1956B to obtain solutions of 150, 200, and 250 p.p.m. of antibiotic. Distilled water was added to aliquots of each concentration of the solutions to make up the following percentages of water by volume: 0.0, 0.5, 1.0, 2.0, 3.0, 4.0, and 5.0. The mixtures were then stirred for 10 minutes at room temperature on a Fisher Thermix<sup>3</sup> at its highest speed setting. Each emulsion was centrifuged at 15,000 times gravity for 15 minutes in a refrigerated centrifuge at 20° C. The upper portion of the oil phase was saved; the lower portion of the oil phase and all the water were discarded. Oil containing 0.2 percent Triton 1956B was used to make subsequent dilutions. A twentyfold dilution was then bioassayed by Whiffen's method.<sup>4</sup> A sample (0.07 ml.) of each solution was applied directly to 12 paper discs (4 discs per plate).

## RESULTS AND DISCUSSION

We originally planned to bioassay all fractions of the oil-water mixture, but it was obvious that not quite all the oil had been removed from the water by centrifuging because the water was tinged faintly but distinctly yellow. Since even high-speed centrifuging did not remove all the oil from the water phase, and since the amount of oil left in the water appeared to vary from sample to sample, the water fraction was not used in the bioassay.

When bioassays using water as the solvent for cycloheximide were carried out, the resulting curves were similar to Whiffen's. These curves could not be obtained when oil containing Triton 1956B was used as the solvent. Failure to obtain suitable bioassay curves from oil solutions was established by statistical analysis of the bioassay curves in figure 1; no significant differences were detected among the three concentrations of cycloheximide.<sup>5</sup>

---

<sup>3</sup> Use of trade name for equipment is solely for identification and does not imply endorsement or recommendation by the Forest Service.

<sup>4</sup> Whiffen, A. J. The production, assay, and antibiotic activity of Acti-dione, an antibiotic from Streptomyces griseus. Jour. Bact. 56: 283. 1948.

<sup>5</sup> Statistical analyses by M. A. Marsden, Statistician, Intermountain Forest and Range Experiment Station, Moscow, Idaho.

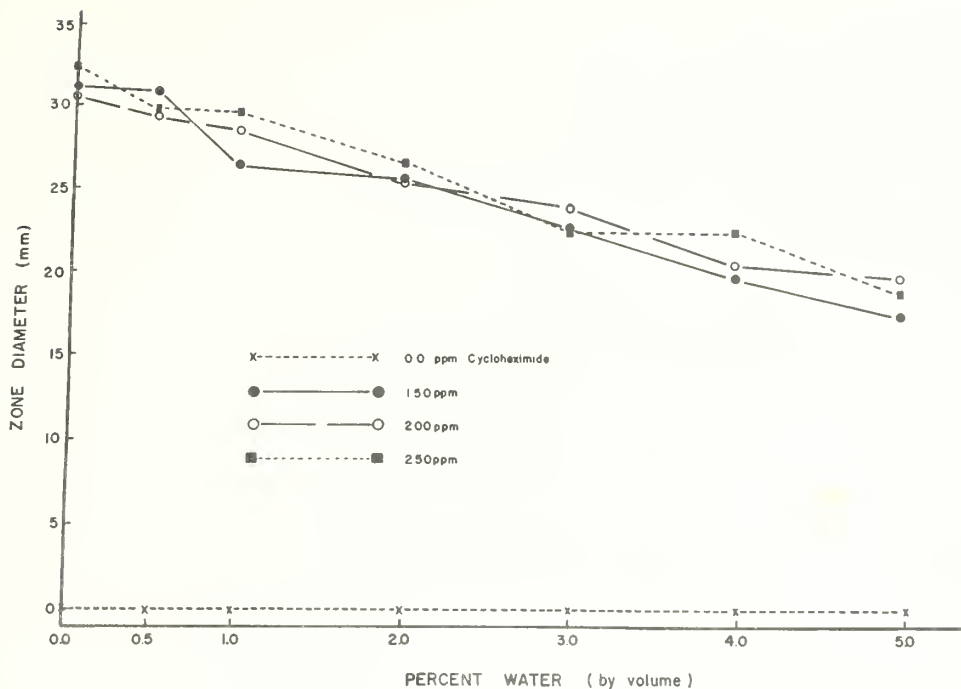

Figure 1.--Inhibition of *Saccharomyces pastorianus* by oil solutions of cycloheximide after extraction with water. Zone sizes include the 12.7 mm. paper disc except for the 0.0 p.p.m. antibiotic solutions, which produced no inhibition zone under the disc.

Although statistical analysis of the data does not show clear separation among the average zone diameters for the three concentrations of the antibiotic, the slope of the regression of zone diameter on percent water was significantly different from zero; i.e., the more water that was in contact with the oil solution of cycloheximide, the more the concentration of the antibiotic in the oil was reduced. Also, the zone diameters at the average concentration of water do fall in the expected sequence according to concentration (fig. 1). The lack of discrimination may be the result of combining a response error due to the water treatment with the inherent variation of the bioassay itself.

Two conclusions are reached from the results of our study.

1. This bioassay procedure using oil containing Triton cannot be used to determine the concentration of cycloheximide.

2. Although we were not able to recommend the amount of antibiotic to be added to compensate, the fact remains that cycloheximide is removed from oil by water, as was originally suggested.<sup>6</sup>

<sup>6</sup> Moss, et al., op. cit., p. 1.





# Research Note

UNITED STATES DEPARTMENT OF AGRICULTURE  
FOREST SERVICE

**INTERMOUNTAIN FOREST & RANGE EXPERIMENT STATION**  
OGDEN UTAH

U.S. Forest Service  
Research Note INT-31

## THERMOCOUPLES FOR FOREST FIRE RESEARCH

Erwin H. Breuer  
Division of Forest Fire Research

### ABSTRACT

Thermocouples have proved valuable in research conducted by the Fire Physics Project at the Northern Forest Fire Laboratory because they can measure several important fire variables besides flame and convection column temperatures. These include rate of spread and flame residence time. Describes a simple, rapid method of fabrication and reports useful and diverse applications of thermocouples in laboratory and field use.

During the past 2½ years, the Northern Forest Fire Laboratory has gained considerable experience in using thermocouples for measuring temperatures and marking such events as distinct rise or decrease in temperature in free-burning fires. This report summarizes our results to date in order to help others who may need to make similar measurements.<sup>1</sup> It also gives directions for fabricating similar devices.

### TECHNOLOGY

Thermocouples are very convenient and useful for measuring temperature in many different applications. They are small, light, relatively inexpensive (except platinum thermocouples), can be mounted at a considerable distance from the indicating instrument, and can be used in places inaccessible to ordinary thermometers.

A thermocouple is simply a junction of two dissimilar metals; at this junction there is a difference in electrical potential. If two junctions are formed by joining both ends of two dissimilar conductors, and if all parts of the circuit are at the same temperature, no current flows as the e.m.f.'s (electromotive forces) around the circuit are equal and are in opposite directions. If one junction is heated, its e.m.f. increases and the two junctions no longer balance. Current

<sup>1</sup> Anderson, Hal E. Mechanisms of fire spread, research progress report no. 1. U.S. Forest Serv. Intermountain Forest and Range Expt. Sta. Res. Paper INT-8, 20 pp., illus. 1964.



flow may be measured, or the circuit may be opened at one place and attached to a potentiometer to measure the net e.m.f. acting around the circuit. This thermoelectric effect may be used to determine the temperature of one junction if the temperature of the other junction (a reference junction maintained at a constant temperature) is known.

The reference junction is a means of connecting a thermocouple to the copper leads of a measuring or indicating system without incurring the errors normally associated with thermal electromotive forces produced at unintended secondary junctions. In installations where power and space are not critical, the problem is solved by maintaining the junction of the thermocouple and copper leads (cold junction) at a constant temperature (with a constant-temperature bath) so that the error attributable to thermal electromotive force is constant and can be calibrated out of the measuring system. This requires time for temperature stabilization before measurements are made.

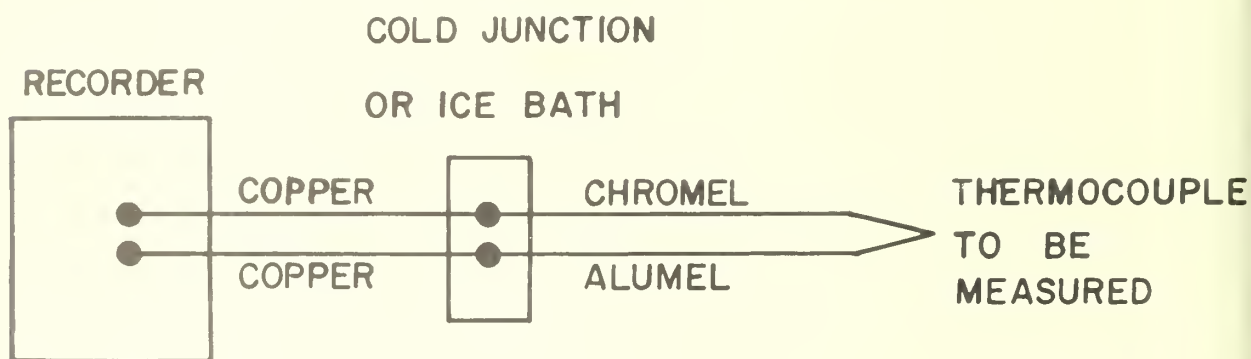

Figure 1.--Basic system of a thermocouple, cold junction, and recorder.

#### TEMPERATURE MEASUREMENT

In the application of thermocouples for temperature recording, the temperature range to be measured must be roughly estimated. The type and gage size is then selected; smaller gages give faster response, but their service life is shorter. The three most commonly used types of thermocouples and their temperature ranges<sup>2</sup> are:

Chromel-alumel	-300 to 2,200° F., maximum 2,450° F.
Iron-constantan	-320 to 1,400° F., maximum 1,800° F.
Copper-constantan	-312 to 650° F., maximum 1,100° F.

Chromel and alumel (nickel base alloys that have excellent tensile properties) are more widely used than other materials because they have a higher temperature range. We have obtained thermocouple material as small as 0.001 inch. When fabricated in the workshop, these are best joined by spot welding, or they can be bought commercially already made up as thermocouples. Larger sizes can be gas-welded by using an oxyacetylene flame and a flux, or by arc welding. Arc welding provides a cleaner bead, a positive fusion, and no oxidation.

<sup>2</sup> Shenker, Henry, John I. Louritzen, Jr., Robert J. Corruccini, and S. T. Lonberger. Reference tables for thermocouples. National Bureau of Standards Cir. 561, 84 pp. 1955.



Thermocouples measure the temperature differential between two junctions of dissimilar metals and thus provide a relative measure. Other types of temperature measuring devices are the thermistor and the resistance thermometer, both of which measure absolute temperature.<sup>3</sup> The fine wire resistance thermometer is capable of almost the same response as a thermocouple, but its sensing element involves a definite length of wire rather than a point and hence gives the average temperature of the wire. Some additional equipment--including a current source and bridge elements--is needed.<sup>4</sup>

### FABRICATION

A simple autogenous welder for rapid fabrication of butt-welded thermocouples can be made from a piece of 2-inch iron pipe 2 inches long butt-welded to a steel plate insulated from electrical ground. Power for welding is provided by a 0-100-volt variable voltage a.c. transformer to compensate for differences in gage of thermocouple wire. One output lead from the transformer is attached to the steel plate; the other lead is attached to the bare ends of the thermocouple. The end to be fused is cleaned of all insulation for about one-fourth inch, and the wires are then twisted together no more than one turn for good sensitivity. Clean mercury is poured into the well to approximately 3/8-inch deep, and an oil having a high flash point, such as transformer oil, is poured on top of the mercury. The oil prevents flashing and the release of mercury vapor, which is toxic. The voltage is set at 20 volts. The twisted end is dipped into the well through the oil to the mercury, where the twisted end will arc because of the continuity of current flow. If fusion does not occur at 20 volts, the voltage is increased gradually in successive trials until fusion is achieved.

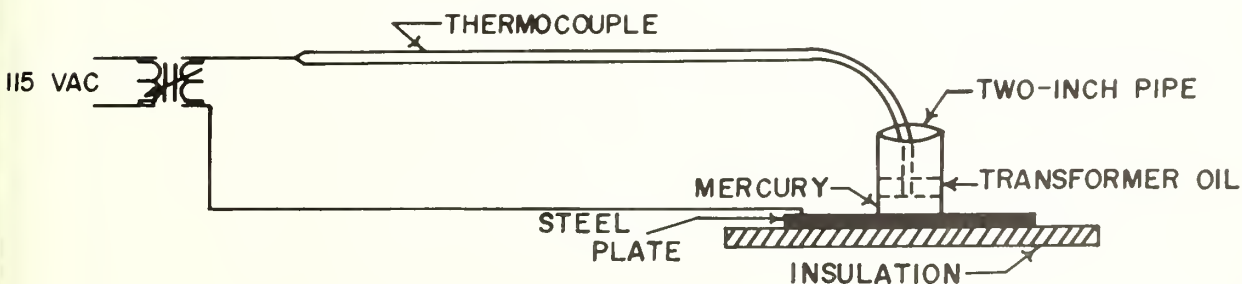

Figure 2.--Thermocouple welder.

<sup>3</sup>Fenwal Electronics. Thermistors--how they compare with thermocouples, resistance thermometers. Capsule Thermistor Course #7, Electronic Design 12(5): 32. 1964.

<sup>4</sup>Hunt, Maynard H. Design and use of fine wire thermocouples for research. U.S. Naval Ordnance Test Station, China Lake, California, 35 pp., illus. September 1959, unclassified.



Figure 3.--Thermocouple  
encased in  $\frac{1}{4}$ -inch  
copper tubing.

Figure 4.--The same  
thermocouple pro-  
tected with  $\frac{5}{8}$ -inch  
copper tubing for  
insertion into fuel  
bed.



## APPLICATIONS

Thermocouples (fig. 3) placed just beneath the surface of a fuel bed and evenly spaced along its centerline have provided considerable information about fire characteristics. The stems of the thermocouples were incased in porcelain insulators inside  $\frac{1}{4}$ -inch copper tubing and sealed with Saureisen sealing cement.<sup>5</sup> In use, the thermocouple junction should protrude one-eighth inch above the copper tubing and should be insulated to reduce the error from conduction. The thermocouple is protected before being inserted into the fuel bed by a cap made of  $\frac{5}{8}$ -inch copper tubing closed at one end (fig. 4). We attached thermocouples to two boards 1 inch by 2 inches by 4 feet for ease of handling 12 thermocouples used in fuel bed tests.

The fuel beds used in the laboratory are 8 feet long by 18 inches wide. Starting 3 inches from one end, we drilled holes 9 inches apart in the base for thermocouple insertion. The thermocouples protrude to within one-fourth inch of the upper surface of the fuel. As the fire passes each thermocouple, the temperature profile is traced on an oscillograph. From the thermocouple trace, in addition to the temperature profile, both the rate of spread and residence time of the fire can be obtained. The types of thermocouples used in laboratory tests in the fuel bed are chromel-alumel 30-gage twisted and butt-welded. For measuring flame and lower convection column temperatures, we have used 24-gage butt-welded chromel-alumel thermocouples placed 3 inches apart and suspended 1 foot above the fuel bed. Butt-welded iron-constantan thermocouples 3 inches apart have been used at the 3-foot level. Five thermocouples wired in parallel and located in the exhaust stack were used for measuring convection temperatures.

## FIELD USE

In a field test at Priest River Experimental Forest in northern Idaho, fuel beds 60 feet long by 6 feet wide with varying depths were constructed from Douglas-fir and lodgepole pine slash in which the limb sizes were varied. Measurements recorded during the burning included the rate of fire spread, flame depth, vertical temperatures within and above the flame, flame base temperature profile, and residence time. The temperature instrumentation consisted of 48 thermocouples made of 24-gage chromel-alumel asbestos and fiberglass-covered wire. The leads for each 12 thermocouples were brought to an ice bath, then to a box of 24 switches that could switch to any station of 12 thermocouples. The leads were then brought to two light-beam oscillographic recorders. This arrangement permitted all four stations of a fuel bed to be monitored with two recorders by switching as the flame front progressed from station to station. The instrumentation stations were designed to be as portable as possible. The assembly was fabricated in the shape of an "F" from  $\frac{3}{4}$ -inch and 1-inch iron pipe (figs. 5 and 6).

A tee at  $1\frac{1}{2}$  feet supported an arm 6 feet long to which were attached six thermocouples 9 inches apart. These were suspended 6 inches above the fuel. The upper and lower arms of the "F" assembly,  $9\frac{1}{2}$  feet apart, were interconnected with piano wire. Six thermocouples were attached vertically to the wire at known heights. One thermocouple was used with a Kiel probe for measuring convection column temperature and pressure. The pressure signal was measured by a differential pressure transducer and displayed upon a single-point strip chart recorder.

---

<sup>5</sup>Saureisen No. 33 is a ceramic adhesive, fireproof, resists acids, and has good electrical insulating properties.



Figure 5.--Thermocouple support system positioned over a slash fuel bed prior to the fire. Note white tie-downs for thermocouples on horizontal and vertical sections.

Figure 6.--Thermocouple assembly engulfed in flame. This type of assembly presents minimum obstruction to the fire.



After use in 18 fires the thermocouples were damaged and charred but were still functioning well. One basic objective of the field experiments was to test measurement techniques and the adaptability of laboratory instrumentation to field operations. Use of thermocouples in the field is certainly feasible. Thermocouples must be handled carefully after fabrication. Also, special care must be taken with the thermos bottles used for the reference junction ice baths. Thermos bottle cold junctions are not well suited to field testing because of the difficulty of obtaining ice in remote areas and the possibility of breaking the bottles. A possible alternative would be to place the junctions underground and then monitor the junction temperature with a separate sensor. Another method would be to use either a self-powered or an externally powered thermocouple reference junction compensator. The first, of course, requires no outside power source and therefore is ideal for field use; but the externally powered compensator would have to have either an a.c. or d.c. power source. Compensators are manufactured to match the thermocouple material used and also for specified reference temperature. They cost more, but the added convenience could offset the cost.

### SUMMARY

Thermocouples have proved to be the most useful device for measuring temperature phenomena in fire research because many materials and wire sizes are available. Thermocouples for studies at the Northern Forest Fire Laboratory have been fabricated with the use of a mercury pool arc welder; they have proved reliable and accurate.

Thermocouple systems have been developed to measure flame and air temperatures and to serve as event recorders. They have facilitated measurement of rate of spread, residence time, flame envelope profile, and temperatures within the flame and in the convection column. The potential use of thermocouples can be great, and is dependent mainly on the ingenuity of the user.



### FOREST SERVICE CREED

The Forest Service of the U.S. Department of Agriculture is dedicated to the principle of multiple use management of the Nation's forest resources for sustained yields of wood, water, forage, wildlife, and recreation. Through forestry research, cooperation with the States and private forest owners, and management of the National Forests and National Grasslands, it strives--as directed by Congress--to provide increasingly greater service to a growing Nation.





# Research Note

UNITED STATES DEPARTMENT OF AGRICULTURE  
FOREST SERVICE

INTERMOUNTAIN FOREST & RANGE EXPERIMENT STATION  
OGDEN UTAH

U.S. Forest Service  
Research Note INT-32

1965

## NEW MEXICO'S FOREST AREA AND TIMBER VOLUME

Henry J. Pissot, Resource Analyst  
Division of Forest Economics and Recreation Research

### ABSTRACT

One-third of New Mexico's 18 million acres of forest land is classed as commercial. Sixty-nine percent of the commercial forest area is publicly administered; 55 percent is in National Forests. Ponderosa pine, the principal species, occupies 69 percent of the commercial timber-growing area and accounts for more than half of the growing stock and sawtimber volume in the State.

Twenty-three percent (18.2 million acres) of New Mexico's land area is forested; however, only 6.3 million acres, or slightly more than one-third of the forested area is commercially important for timber production. The remaining 66 percent is in two broad classes of noncommercial forest land. About 561,000 acres is productive but excluded from the commercial classification because it is reserved from timber harvesting in National Forest wild, wilderness, and primitive areas, and in National Monuments. The major portion of the noncommercial area (11.4 million acres) is unproductive land incapable of producing trees of commercial size and quality. The pinyon-juniper forest type occupies 94 percent of this unproductive category.

Public agencies manage 4.3 million acres, or 69 percent of the commercial forest. Of this, 80 percent is National Forest land and 14 percent is tribal lands within Indian Reservations. The remaining public lands are largely in State ownership.

Private holdings amount to 2 million acres, or 31 percent of the commercial area. Four-fifths of this is in farms and ranches.



Ponderosa pine, the most extensive commercial forest type in New Mexico, covers 4.3 million acres, or 69 percent of the commercial area. The other important softwood types are Douglas-fir and fir-spruce, which make up about 16 and 8 percent, respectively, of the commercial forest. Aspen, the only hardwood type in the commercial forest, occupies 6 percent of the area.

Sawtimber stands support 98 percent of the total board-foot volume, occupy 87 percent of the commercial forest land, and average 5,072 board feet per acre. The total cubic volume in sound live trees 5 inches in diameter and larger is 6.6 billion feet. Fifty-eight percent of it is ponderosa pine, which leads all species in sawtimber volume, with 16 billion of the State's total of 28 billion board feet.

\* \* \* \* \*

Statistics shown in the following tables were compiled from several sources. The principal sources were inventories by National Forests, the Bureau of Indian Affairs, and the Forest Survey staff of the Intermountain Forest and Range Experiment Station. A combination of photo interpretation and field examination of sample areas was used to obtain data for most areas. Fieldwork was completed in 1962, compilations in 1964

More comprehensive timber estimates will be included in an analytical report for the State of New Mexico that will be published later this year.

Table 1.--New Mexico area by land classes

Land class	Thousand acres
Commercial forest land <sup>1</sup>	6,269
Unproductive forest land <sup>2</sup>	11,357
Productive-reserved forest land <sup>3</sup>	561
Total forest land	18,187
Nonforest land	59,579
All land	<sup>4</sup> 77,766

<sup>1</sup> Forest land that is producing or is capable of producing crops of industrial wood and not withdrawn from timber utilization.

<sup>2</sup> Forest land incapable of growing crops of industrial wood because of adverse site conditions.

<sup>3</sup> Productive forest land withdrawn from timber utilization through statute or administrative regulation.

<sup>4</sup> From U.S. Bureau of the Census, Land and Water Area of the United States, 1960.

Table 2.--Area of commercial forest land in New Mexico by ownership classes

Ownership class	Thousand acres
National Forest	3,458
Other Federal:	
Bureau of Land Management	77
Indian <sup>1</sup>	617
Miscellaneous Federal	9
Total other Federal	703
State	172
Farmer-owned	1,557
Other private	379
All ownerships	6,269

<sup>1</sup> Indian tribal lands and trust allotments; i.e. lands held in fee by the Federal Government but administered and managed for Indian tribal groups or allotted in trust to individual Indians.



Table 3.--Area of commercial forest land in New Mexico by stand-size and ownership classes

Stand-size class	All ownerships	National Forest	Other public	Private
----- Thousand acres -----				
Sawtimber stands <sup>1</sup>	5,454	2,950	833	1,671
Poletimber stands <sup>2</sup>	426	275	19	132
Sapling and seedling stands <sup>3</sup>	169	16	20	133
Nonstocked stands <sup>4</sup>	220	217	3	--
All classes	6,269	3,458	875	1,936

<sup>1</sup> Stands at least 10-percent stocked with growing stock trees with a minimum net volume per acre of 1,500 board feet in sawtimber trees.

<sup>2</sup> Stands failing to meet sawtimber stand specifications, but at least 10-percent stocked with poletimber and larger (5.0 inches d.b.h. and larger) trees and with at least half the minimum stocking in poletimber trees.

<sup>3</sup> A stand not qualifying as either a sawtimber or poletimber stand, but having at least 10-percent stocking of trees of commercial species and with at least half the stocking in sapling and seedling trees (less than 5.0 inches d.b.h.).

<sup>4</sup> A stand not qualifying as a sawtimber, poletimber, or a sapling-seedling stand; i.e., normally a stand less than 10-percent stocked.

Table 4.--Area of commercial forest land in New Mexico by forest types and ownership classes

Forest type	All ownerships	Public	Private
----- Thousand acres -----			
Douglas-fir	1,000	582	418
Ponderosa pine	4,334	3,262	1,072
Limber pine	43	10	33
Fir-spruce	525	290	235
Aspen	367	189	178
All types	6,269	4,333	1,936

Table 5.--Area of noncommercial forest land in New Mexico by forest types

Forest type	All areas	Productive reserved areas	Unproductive areas
----- Thousand acres -----			
Douglas-fir	122	120	2
Ponderosa pine	347	307	40
Fir-spruce	129	122	7
Aspen	33	12	21
Chaparral	652	--	652
Pinyon-juniper	10,635	--	10,635
All types	11,918	561	11,357

Table 6.--Volume of growing stock and sawtimber on commercial forest land in New Mexico by species

Species	⋮	Growing stock <sup>1</sup>	⋮	Sawtimber
	⋮	Thousand cubic feet	⋮	Thousand board feet <sup>2</sup>
Douglas-fir		941,567		5,025,065
Ponderosa pine		3,837,291		16,188,163
Limber pine		157,656		639,953
True firs <sup>3</sup>		594,262		1,975,857
Engelmann spruce		706,389		3,280,615
Aspen		379,074		1,233,056
All species		6,616,239		28,342,709

<sup>1</sup> Net volume in cubic feet of live merchantable sawtimber and poletimber trees from a 1-foot stump to a minimum 4.0-inch top inside bark.

<sup>2</sup> International  $\frac{1}{4}$ -inch log rule.

<sup>3</sup> Corkbark, subalpine, and white fir.

Table 7.--Volume of growing stock and sawtimber on commercial forest land in New Mexico by ownership classes

Ownership class	⋮	Growing stock	⋮	Sawtimber
	⋮	Thousand cubic feet	⋮	Thousand board feet <sup>1</sup>
National Forest		3,386,868		14,859,252
Other public		1,368,926		6,243,006
Private		1,860,445		7,240,451
All classes		6,616,239		28,342,709

<sup>1</sup> International  $\frac{1}{4}$ -inch log rule.

Table 8.--Volume of growing stock and sawtimber on commercial forest land in New Mexico by stand-size classes

Stand-size class	⋮	Growing stock	⋮	Sawtimber
	⋮	Thousand cubic feet	⋮	Thousand board feet <sup>1</sup>
Sawtimber stands		6,320,179		27,662,064
Poletimber stands		230,691		492,421
Sapling and seedling stands		38,062		63,398
Nonstocked stands		27,307		124,826
All classes		6,616,239		28,342,709

<sup>1</sup> International  $\frac{1}{4}$ -inch log rule.



# Research Note

UNITED STATES DEPARTMENT OF AGRICULTURE  
FOREST SERVICE

INTERMOUNTAIN FOREST & RANGE EXPERIMENT STATION  
OGDEN UTAH



U.S. Forest Service  
Research Note INT-33

1965

## ARIZONA'S FOREST AREA AND TIMBER VOLUME

Dorothy G. Shupe, Statistical Clerk  
Division of Forest Economics and Recreation Research

### ABSTRACT

Arizona's 21 million acres of forest land includes only 4 million acres classed as commercial. Of this commercial forest area, 96 percent is publicly administered and 66 percent is in National Forests. The ponderosa pine timber type occupies 92 percent of the commercial forest area. This species accounts for 85 percent of both the growing stock and sawtimber volume in the State.

Arizona, although generally considered a desert State, ranks thirteenth among the 50 States and fourth among the Rocky Mountain States in forest area. Forest lands occupy 20.6 million acres, or 28 percent of the total land area of the State.

Only 4 million acres, or 19 percent of the forest, are classed as commercial, that is, suitable for production of industrial timber products. The other 81 percent is in two categories. Some 353,000 acres are productive but are classed as noncommercial because they are reserved from timber cutting in National Forest wild, wilderness, and primitive areas, and in National Parks and National Monuments. The remainder of the noncommercial area (nearly 16.3 million acres) is incapable of growing timber crops suitable for forest industry because of adverse site conditions. This area is largely a transition zone between desert and commercial forest. Its cover is principally (75 percent) pinyon-juniper; the remainder is mostly chaparral.

Ninety-six percent of the commercial forest land is publicly owned or managed. The 4 percent that is in private ownership is the smallest proportion of privately owned commercial forest land in any of the Rocky Mountain States.

Most of the commercial forest area in Arizona (92 percent or 3.7 million acres) is in the ponderosa pine type.

The total volume of merchantable trees 5.0 inches in diameter and larger is 6 billion cubic feet, nearly all of it in sawtimber stands. The total sawtimber volume is 27 billion board feet. Eighty-five percent of it (23 billion board feet) is ponderosa pine. Arizona has more ponderosa pine volume than any other Rocky Mountain State.

\* \* \* \* \*

Statistics shown in the following tables were compiled from several sources. The principal sources were inventories by the National Forests, the Bureau of Indian Affairs, and the Forest Survey staff of the Intermountain Forest and Range Experiment Station. A combination of photo interpretation and field examination of sample areas was used to obtain data for most areas. Fieldwork was completed in 1962, compilations in 1964.

More comprehensive timber statistics will be included in an analytical report for the State that will be published later this year.

Table 1.--Arizona area by land classes

Land class	: Thousand acres
Commercial forest land <sup>1</sup>	3,977
Unproductive forest land <sup>2</sup>	16,268
Productive-reserved forest land <sup>3</sup>	353
Total forest land	20,598
Nonforest land	52,090
All land	<sup>4</sup> 72,688

<sup>1</sup>Forest land that is producing or is capable of producing crops of industrial wood and not withdrawn from timber utilization.

<sup>2</sup>Forest land incapable of growing crops of industrial wood because of adverse site conditions.

<sup>3</sup>Productive forest land withdrawn from timber utilization through statute or administrative regulation.

<sup>4</sup>From U.S. Bureau of the Census, Land and Water Area of the United States, 1960.

Table 2.--Area of commercial forest land in Arizona by ownership classes

Ownership class	: Thousand acres
National Forest	2,630
Other Federal:	
Bureau of Land Management	2
Indian <sup>1</sup>	1,144
Total other Federal	1,146
State	32
County and municipal	2
Farmer-owned	82
Other private	85
All ownerships	3,977

<sup>1</sup> Indian tribal lands and trust allotments; that is lands held in fee by the Federal Government but administered and managed for Indian tribal groups or allotted in trust to individual Indians.

Table 3.--Area of commercial forest land in Arizona by stand-size and ownership classes

Stand-size class	All ownerships	Public	Private
----- Thousand acres -----			
Sawtimber stands <sup>1</sup>	3,743	3,607	136
Poletimber stands <sup>2</sup>	128	114	14
Sapling and seedling stands <sup>3</sup>	41	24	17
Nonstocked stands <sup>4</sup>	65	65	--
All classes	3,977	3,810	167

<sup>1</sup> Stands at least 10-percent stocked with growing stock trees with a minimum net volume per acre of 1,500 board feet in sawtimber trees.

<sup>2</sup> Stands failing to meet the sawtimber stand specifications, but at least 10-percent stocked with poletimber and larger (5.0 inches d.b.h. and larger) trees and with at least half the minimum stocking in poletimber trees.

<sup>3</sup> A stand not qualifying as either a sawtimber or poletimber stand, but having at least 10-percent stocking of trees of commercial species and with at least half the stocking in sapling and seedling trees (less than 5.0 inches d.b.h.).

<sup>4</sup> A stand not qualifying as a sawtimber, poletimber, or a sapling-seedling stand; i.e., normally a stand less than 10-percent stocked.

Table 4.--Area of commercial forest land in Arizona by forest types and ownership classes

Forest type	All ownerships	Public	Private
----- Thousand acres -----			
Douglas-fir	130	130	--
Ponderosa pine	3,658	3,515	143
Fir-spruce	110	110	--
Aspen	79	55	24
All types	3,977	3,810	167

Table 5.--Area of noncommercial forest land in Arizona by forest types

Forest type	All areas	Productive reserved areas	Unproductive areas
----- Thousand acres -----			
Douglas-fir	7	7	--
Ponderosa pine	624	345	279
Fir-spruce	1	1	--
Chaparral	3,728	--	3,728
Pinyon-juniper	12,249	--	12,249
Arizona cypress	12	--	12
All types	16,621	353	16,268

Table 6. -- Volume of growing stock and sawtimber on commercial forest land in Arizona by species

Species	⋮	Growing stock <sup>1</sup>	⋮	Sawtimber
	⋮	Thousand cubic feet	⋮	Thousand board feet <sup>2</sup>
Douglas-fir		282,510		1,476,300
Ponderosa pine		5,204,562		22,883,386
Limber pine		39,215		186,280
True firs <sup>3</sup>		210,108		932,040
Engelmann spruce		230,810		1,214,431
Aspen		123,986		258,521
All species		6,091,191		26,950,958

<sup>1</sup> Net volume in cubic feet of live merchantable sawtimber trees and poletimber trees from a 1-foot stump to a minimum 4.0-inch top inside bark.

<sup>2</sup> International  $\frac{1}{4}$ -inch log rule.

<sup>3</sup> Corkbark, subalpine, and white fir.

Table 7. -- Volume of growing stock and sawtimber on commercial forest land in Arizona by ownership classes

Ownership class	⋮	Growing stock	⋮	Sawtimber
	⋮	Thousand cubic feet	⋮	Thousand board feet <sup>1</sup>
National Forest		4,389,191		19,153,180
Other public		1,556,126		7,296,681
Private		145,874		501,097
All classes		6,091,191		26,950,958

<sup>1</sup> International  $\frac{1}{4}$ -inch log rule.

Table 8. -- Volume of growing stock and sawtimber on commercial forest land in Arizona by stand-size classes

Stand-size class	⋮	Growing stock	⋮	Sawtimber
	⋮	Thousand cubic feet	⋮	Thousand board feet <sup>1</sup>
Sawtimber stands		5,948,767		26,694,125
Poletimber stands		136,478		237,489
Sapling and seedling stands		5,268		15,928
Nonstocked stands		678		3,416
All classes		6,091,191		26,950,958

<sup>1</sup> International  $\frac{1}{4}$ -inch log rule.



# Research Note

UNITED STATES DEPARTMENT OF AGRICULTURE  
FOREST SERVICE

**INTERMOUNTAIN FOREST & RANGE EXPERIMENT STATION**  
OGDEN UTAH

U.S. Forest Service  
Research Note INT-34

1965

## THE INTERMOUNTAIN PRECIPITATION STORAGE GAGE

Norbert V. DeByle and Harold F. Haupt  
Research Foresters  
Division of Watershed Management Research<sup>1</sup>

### ABSTRACT

A modified standpipe is recommended as a rugged, vandalproof precipitation storage gage that is relatively easy to erect. It has proved satisfactory on sites receiving 60 inches or less of precipitation during the storage season.

### INTRODUCTION

Precipitation storage gages have been used since the last century (Kurtyka 1953), but have undergone considerable development and modification in the United States during the past 50 years (USWB 1959). The standpipe storage gage is now commonly used by the U.S. Weather Bureau in deep snow country. It is fabricated from 5-foot sections of 12-inch-diameter, 10-gage steel pipe. An 18-inch-long truncated cone forms the top of the gage, reducing the catch ring to a diameter of 8 inches. This gage does not require a mounting tower, but forms its own support (USWB 1959).

A gage modeled after the standpipe is now made of reinforced fiber glass. It is formed in a single 16½-foot-tall section. Its advantages are lightness in weight, strength, resistance to corrosion, imperviousness, and ease of machining and patching (Billones 1963).

A special storage gage has been developed recently, primarily for use on rangelands, foothills, and desert areas. It has a maximum precipitation capacity of 35 inches, is only 14 inches high, and is mounted on a single 2-inch-diameter pipe (Collett and Warnick 1962).

Prior to the development of the last two gages mentioned above, the Intermountain Station designed, had fabricated, and put into use several precipitation storage gages that were a modification of the metal standpipe gage. The Intermountain modification is especially suited to use on inaccessible sites. It is less expensive to build than the metal standpipe gage, is easily erected and readily serviced, and has proved relatively vandalproof.

<sup>1</sup> Located respectively at Forestry Sciences Laboratories, Intermountain Forest and Range Experiment Station, maintained in cooperation with Utah State University, Logan, and University of Idaho, Moscow.



## CONSTRUCTION

The Intermountain precipitation gage is mounted on a single  $3\frac{1}{2}$ -inch pipe of sufficient height to project the gage and its shield above the top of the maximum expected snowpack, and beyond the reach of most vandals (fig. 1). The gage tank is 40 inches tall, 12 inches inside diameter, and is fabricated of 12 gage or heavier steel (fig. 2). (This weight of steel usually is not penetrated by .22 caliber rimfire bullets.) A cone 18 inches long, welded to the top of the gage tank, reduces the orifice to a standard 8-inch diameter. Windshield support brackets are welded to the top of the tank section, and a drain assembly is attached at the bottom (fig. 3). To reduce the likelihood that the gage tank might be drained by vandals, the valve handle may be removed except when in use, and the pipe cap over the drain may be tightened so a wrench is required to remove it.

The support pipe should be imbedded in concrete to provide a firm foundation and insure that the gage will remain in a vertical position, especially when full. Besides providing support, the concrete will prevent the pipe from rusting. Braces of angle iron may be welded to the pipe support to increase anchorage in the concrete. If the gage is found to be unstable despite these precautions, anchor cables may be attached to the three eyehooks welded near the top of the support pipe. Turnbuckles installed in these cables will aid in tightening them. (Anchor cables were found necessary on only one of five gages on the east side of the Sierra Nevada, where annual precipitation is approximately 30 inches.)

Both the inside and outside of the gage and the outside of the support pipe should be painted with rust resistant paint. Maximum radiation will be absorbed if the outside of the gage is painted black; this aids in melting any snow caught above the antifreeze solution.

To obtain a representative catch of precipitation in most locations, a windshield is required around the orifice, especially if most precipitation falls as snow accompanied with wind (Wilson 1954). A modified Alter windshield, unlike the one shown in figure 1, is now recommended for this type of gage (Warnick 1956). A windshield of this design made of fiber glass leaves is in the developmental stage.<sup>2</sup>

<sup>2</sup> Personal communication with Coit Manufacturing Company, Mendota, Calif., 1964.



Figure 1.--The Intermountain precipitation storage gage fitted with an Alter windshield. Although not apparent in the photograph, this gage is sheltered by forest on three sides.



Figure 2. -- Construction details of the Inter-mountain precipitation storage gage.

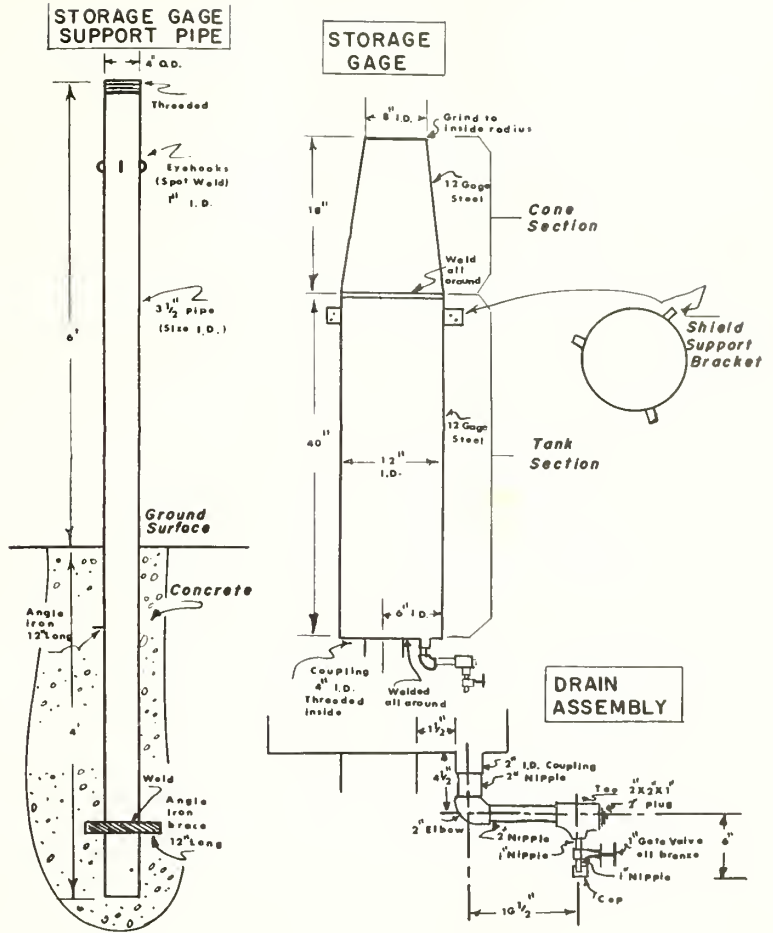

The storage gage may be fabricated in most local machine shops with commonly available materials. The gage can be carried to the site in easily handled units, readily assembled with hand tools, and erected. If a water supply is available, mounting the support pipe in concrete is not difficult. Only a shovel, a heavy plastic tarp, and a few bags of mixed cement, aggregate, and sand are needed.

### SERVICING

A modified standpipe gage has a capacity of 90 inches' precipitation in the tank section. The capacity of the cone increases the total capacity of the gage. However, the cone section should normally function as dead-air space to trap and melt snow. In mountainous areas, where most winter precipitation is snow and where minimum winter temperatures are well below freezing, the storage gage must be charged with an antifreeze solution. Ethylene glycol is recommended in amount sufficient to protect the contents of the gage from freezing during the coldest weather expected (Kidd 1960). Also, a layer of low viscosity oil, approximately 0.15-inch thick, should float on the surface of the stored precipitation to prevent evaporation (Hamilton and Andrews 1953). A typical winter charge (antifreeze, water, and oil) will fill about 30 inches of the gage capacity, leaving storage space for 60 inches' precipitation.

Access to the orifice of the gage, for charging or maintenance, is with a stepladder. A light, magnesium, 12-foot stepladder is quite satisfactory. An alternate access, especially if the gage is isolated, or if vandalism is not anticipated, is provided by steps welded to the support pipe and gage tank (not illustrated).

This gage is recommended as a sturdy, vandalproof storage gage that is relatively easy to erect. It performs satisfactorily on any site receiving 60 inches or less precipitation during the winter storage season.

Figure 3.--Closeup of drain assembly visible on the gage in figure 1.

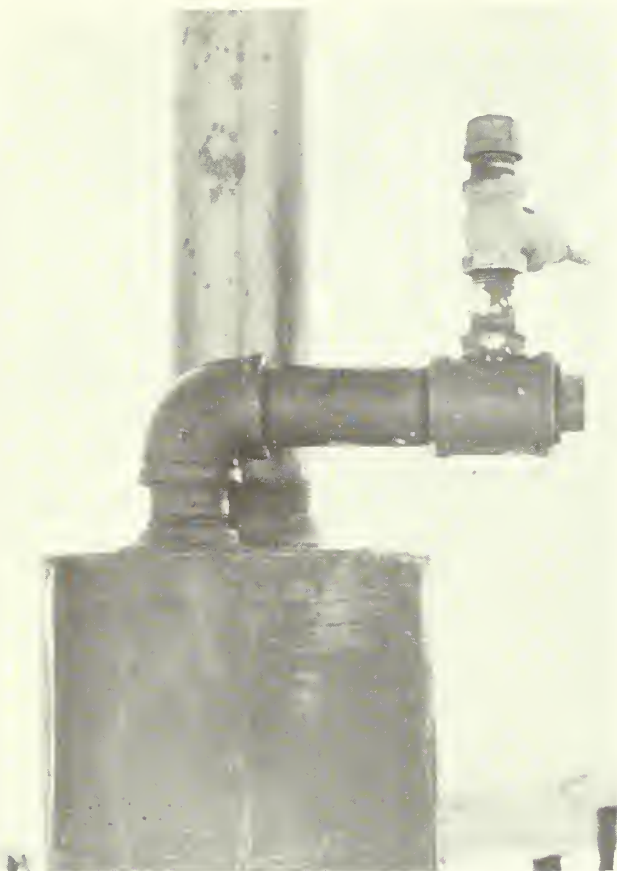

#### LITERATURE CITED

- Billones, Louis.  
1963. Operational problems of storage precipitation gages. 31st Western Snow Conf. Proc., pp. 74-76.
- Collett, F. R., and Warnick, C. C.  
1962. Idaho reconnaissance precipitation gage. Idaho Engin. Expt. Sta. Cir. 1. 16 pp.
- Hamilton, E. L., and Andrews, L. A.  
1953. Control of evaporation from rain gages by oil. Amer. Met. Soc. Bull. 34(5): 202-204.
- Kidd, W. J., Jr.  
1960. The advantages of using ethylene glycol in seasonal storage precipitation gages and a method for computing the initial charge. Jour. Forestry 58(11): 882-884.
- Kurtyka, John C.  
1953. Precipitation measurements study. Illinois State Water Survey Rpt. of Investigation No. 20, 178 pp.
- U.S. Weather Bureau.  
1959. Precipitation data from storage-gage stations. Climatography of the United States No. 70-4 (Calif.), 39 pp.
- Warnick, C. C.  
1956. Influence of wind on precipitation measurements at high altitudes. Idaho Engin. Expt. Sta. Bull. 10, 63 pp.
- Wilson, Walter T.  
1954. Analysis of winter precipitation observations in the Cooperative Snow Investigations. Monthly Weather Rev. 82(7): 183-199.



# Research Note

UNITED STATES DEPARTMENT OF AGRICULTURE  
FOREST SERVICE

**INTERMOUNTAIN FOREST & RANGE EXPERIMENT STATION**  
OGDEN UTAH

U.S. Forest Service  
Research Note INT-35

1965

## NATURAL ESTABLISHMENT OF PONDEROSA PINE IN CENTRAL IDAHO

Marvin W. Foiles and James D. Curtis<sup>1</sup>  
Research Foresters  
Division of Forest Disease and Timber Management Research

### ABSTRACT

The rare coincidence of a good cone crop followed immediately by a comparatively cool, moist summer produced unusually abundant ponderosa pine seedlings in 1963. This paper compares natural stocking in 1963 with that recorded in 1959 following the usual severe summer weather of central Idaho.



In central Idaho, summers with weather conducive to seedling survival are rare, but they do occur. The coincidence of a ponderosa pine cone crop and a subsequent favorable growing season is even more rare. Such a coincidence occurred in 1963--the first since 1941--and provided an unusual opportunity to observe natural widespread establishment of ponderosa pine (*Pinus ponderosa* Laws.) seedlings.

Numbers of emerging seedlings in the spring of 1963 were noticeable, but not impressive. The possibility of an exceptionally successful regeneration year gradually became evident during July and August, when we observed that large numbers of seedlings were surviving the normal drought period. Live seedlings were growing in the most unusual places (figs. 1 and 2), such as in dense grass, in deep duff and litter, at the base of shrubs, and on old stumps and logs. In most years all of these seedlings would have succumbed to drought or to competition before the end of summer.

Weather in central Idaho, especially during the growing season, is usually a critical factor in the survival of forest reproduction. Annual precipitation, usually 20 to 24 inches, falls mostly in winter and spring. Summer rainfall is often only a trace, temperatures are high, and relative humidities from only 7 to 12 percent are common. This combination of severe climate and shallow, desiccative soils does not favor seedling survival and establishment in this part of the species' range.

<sup>1</sup> Headquartered at Intermountain Forest and Range Experiment Station, Boise, Idaho.



Figure 1.--The tap root of this live 1963 ponderosa pine seedling, photographed in October, had penetrated 3.5 inches of pine needle duff. Fifty-cent coin rests on mineral soil.

#### MEASUREMENTS

Since many seedlings were still alive in the fall, it was decided to record their numbers and distribution. The transects used in 1959 to study natural regeneration on scarified group cuttings on the Boise Basin Experimental Forest provided an opportunity to compare seedling survival in 1963 with that of a drier year.<sup>2</sup> The earlier study included measurements of seedfall and subsequent stocking on 36 scarified group cuttings and 11 unscarified sites. Limited time and manpower restricted the 1963 study to remeasuring six of the same clearcut groups--three scarified and three unscarified--and comparing climatic records for the two years.

Transects of continuous milacre quadrats employed in the 1959 study were used again to record quadrat stocking and numbers of seedlings. In November the presence or absence of at least one 1963 seedling and the total number of seedlings were recorded for each quadrat. Quadrat stocking and numbers of seedlings per acre were calculated from the presence of seedlings and numbers of seedlings tallied.

<sup>2</sup> Foiles, Marvin W., and James D. Curtis. Natural regeneration of ponderosa pine on scarified group clear cuttings in central Idaho. (In press.)

Figure 2.--This live 1963 ponderosa pine seedling, photographed in October, survived competition from dense grass.



## WEATHER

What was responsible for the unusually successful natural regeneration in 1963? Why were seedlings able to survive even on normally severe sites despite vigorous vegetative competition?

Favorable weather was probably a major factor. The weather was relatively cool and moist during the summer months of 1963 (table 1). Total June precipitation in 1963 was almost 3 inches above average and 3.5 inches greater than that of June 1959. The precipitation in July 1963 was almost lacking, and in August was but a third of that in 1959. This low rainfall was partially offset by cool temperatures; the average temperature for July was nearly 4° below the 30-year mean.

Table 1.--Total precipitation and average temperatures in Idaho City, Idaho,  
for the summer months of 1959 and 1963

Month	Total precipitation			Average temperature			Days max. temp. 90° F. or above	
	1959	1963	30-year average	1959	1963	30-year average	1959	1963
	<u>Inches</u>			<u>Degrees F.</u>			<u>Number</u>	
June	0.66	4.15	1.24	61.0	58.2	58.6	2	0
July	0.00	0.02	0.27	67.6	62.9	66.8	20	1
August	1.42	0.45	0.30	62.2	64.8	64.9	6	12

Pine silviculturists generally agree that low moisture content of the soil during the growing season is a critical factor in survival of ponderosa pine seedlings. In 1963 the soil was moist in early July because of the heavy rains in late June. June precipitation had been deficient in 1959. The effect of shortage of soil moisture in 1959 was intensified by the long, hot, dry period in June, July, and August which totaled 50 consecutive rainless days. Within that dry period, 26 days had maximum temperatures of 90° F. or above. In contrast, July of 1963 had only 1 day with a maximum temperature of 90° F., and the average maximum temperature was 7.5° lower than in 1959. Thus, in contrast to July of 1959, which was hot and dry, July of 1963 was cool and dry, and resulted in higher survival of seedlings.

## RESULTS

Seed.--Measurements of seedfall from the bumper cone crop of 1958 averaged 245,240 seeds per acre on the clearcut areas. Seedfall from the 1962 crop was not measured, but observations indicated that it was less than half that of the 1958 crop.

Stocking (quadrats).--Stocking was expressed as the percentage of milacre quadrats containing at least one seedling. On the stocked-quadrat basis the stocking percentage was higher in 1963 than in 1959 on five of the six areas; the sixth one was 100-percent stocked both years (table 2). The differences in stocking are most striking on the unscarified areas, where two of the three tracts were complete failures in 1959, but were stocked 67 and 92 percent in 1963. Both areas had been well stocked in the spring of 1959, but no seedlings survived the summer drought of that year. The differences on the scarified areas, although smaller than on unscarified sites, are important because in 1959 those sites were freshly scarified and free of competing vegetation, whereas by 1963 these sites were completely revegetated.

Stocking (number of seedlings).--Density of stocking was expressed as the number of live seedlings per acre at the end of the first growing season (table 2). In November 1963, all six areas contained at least 3,500 seedlings per acre, and five of the six areas were more densely stocked than in 1959. Even the unscarified areas contained 3,500 to 7,210 seedlings per acre in 1963. This seedling density was a marked contrast to that of the 1959 season in which all the seedlings died on two unscarified tracts and only 368 seedlings per acre survived on the third area.

Table 2.--Quadrat stocking and numbers of ponderosa pine in 1959 and in 1963 on clearcut groups in central Idaho after the first growing season

Aspect	Quadrats stocked		Seedlings per acre	
	1959	1963	1959	1963
	Percent		Number	
<u>SCARIFIED IN 1958</u>				
Northwest	73	93	7,400	12,133
West	37	78	1,000	4,259
Level (ravine bottom)	100	100	206,000	128,400
<u>NOT SCARIFIED</u>				
South	0	67	0	3,500
West	21	95	368	7,210
Level (ridge)	0	92	0	6,583

#### DISCUSSION

What will happen to the 1963 bumper crop of ponderosa pine seedlings?

From the standpoint of persistence, certainly numbers are in their favor. Many of them still face severe competition from grass, sedge, brush, and other vegetation for several years. However, they were helped through the critical first year by a cool damp summer. Some of these seedlings will thrive and become dominant fairly soon; others will struggle and fall behind their neighbors. Still others will perish from the multitude of destructive agents to which all young seedlings are subject. This pattern of intense competition is evident in the seedlings and saplings that became established 21 years earlier in the same general area. These 1941 seedlings now vary from a foot or so to some 30 feet in height depending on the competition they have endured. Some of them occur singly; others are in groups, depending on where they established themselves. They appear to have different ages, but actually they are the same age. The 1963 seedlings constitute yet another "wave" of reproduction, a newly added age class, of a typical ponderosa pine forest in central Idaho.

It is instructive to observe that from the silvicultural standpoint of planning for reproduction, it would have been impossible to anticipate the combination of events that culminated in the unusually abundant seedling establishment in 1963.



# Research Note

UNITED STATES DEPARTMENT OF AGRICULTURE  
FOREST SERVICE

**INTERMOUNTAIN FOREST & RANGE EXPERIMENT STATION**  
OGDEN UTAH



U.S. Forest Service  
Research Note INT-36

1965

## PREPARING REPRODUCIBLE PINE NEEDLE FUEL BEDS

Robert D. Schuette, General Physical Scientist  
Division of Forest Fire Research

### ABSTRACT

Describes techniques, developed and tested over a 3-year period, for collecting and conditioning pine needles and for preparing uniform fuel beds from them. These fuel beds had approximately identical burning characteristics and functioned satisfactorily in studies of rates of fire spread and effectiveness of chemical fire retardants.

Free-burning fires have been investigated at the Northern Forest Fire Laboratory for the past 4 years. This paper describes the preparation of uniform fuel beds of ponderosa pine and white pine needles necessary to the conduct of experiments on fire characteristics. To study fire characteristics, it was necessary to develop a fuel bed having reproducible features. Could a technique be developed for constructing a fuel bed that would be reproducible? This paper describes the preparation of such a fuel bed.

For series of controlled experimental fires burned in determining fire characteristics, uniform fuel beds having reproducible features that will assure exactly comparable burning conditions are a prime necessity. The major features of a uniform fuel bed are the loading per unit area and the compactness of the fuel. This paper describes a technique that has been developed, through 4 years' experience at the Fire Laboratory, for preparing such reproducible fuel beds of needles from ponderosa pine and white pine.

### FUEL COLLECTION

Collecting a sufficient quantity of recently cast dead needles insures consistency in fuel texture and calorific content. The current season's needle casts, collected in the autumn, are best for use in experimental burning because they have not been subjected to weathering and decay.

Needles should be collected from the ground underneath a pure stand of the desired species. The collection area should be prepared in advance by removing surface litter so as to provide uniform fuel with a minimum of cleaning.

A grass rake has worked best for raking the needles into piles. Needles have been damaged less when they were bulk loaded into the bed of a truck than when they were sacked. They were then transported to a storage area for cleaning and drying. The cleaning was performed by dropping the needles in front of a circulating fan into a wire basket and removing any large pieces of foreign matter by hand. The circulating fan separated most of the finer foreign particles from the needles. The needles were then scattered uniformly about the floor of the storage room and turned twice a day until dry. After drying, they were stored in open bins in the warehouse until needed.

The two conditioning chambers at the Northern Forest Fire Laboratory bring fuels to desired fuel moisture content. These chambers are vapor-sealed and have automatic temperature control and forced-air circulation. Relative humidity in these chambers is held constant by use of saturated salt solutions.

Each chamber accommodates four 24-by 36-by 10-inch wire baskets, each of which holds about 10 pounds of fuel; and nine trays, each of which contains 1 gallon of salt solution (fig. 1). The desired relative humidity is established by circulating air over these trays of saturated salt solution and through the baskets of pine needles. The 9 gallons of salt solution were ample to condition 40 pounds of fuel per cabinet. The fuel moisture level was established by the relative humidity of the air.



Figure 1.--Loading ponderosa pine needles into conditioning cabinet.



Many types of inorganic salt solutions<sup>1</sup> will maintain constant levels of relative humidity in an enclosed chamber. To be most useful in conditioning fuels, the solution should be able to maintain a fairly uniform relative humidity over a wide range of temperatures. Silica gel was used as a desiccant to obtain an experimentally determined relative humidity of 6.5 percent at 90° F. Several inorganic salts proved to be effective in the conditioning of needle fuels (table 1).

Under any given environmental condition, different fuels may have different equilibrium moisture contents. White pine needles had a higher moisture content than ponderosa pine needles under identical conditions in the conditioning cabinets (table 1).

Table 1. --Inorganic salts for fuel conditioning

Salt	Chemical formula	Humidity condition determined--				Approximate moisture content	
		Experimentally		Theoretically		White pine	Ponderosa pine
		Percent	Degrees F.	Percent	Degrees F.	Percent	Percent
Potassium hydroxide	KOH	9	90	8	77	4.6	3.8
Lithium chloride	LiCl	15	90	11	91 ± 14	5.5	4.5
Potassium acetate	KC <sub>2</sub> H <sub>3</sub> O <sub>2</sub>	22	90	20	77	6.5	5.7
Magnesium chloride	MgCl <sub>2</sub> ·6H <sub>2</sub> O	30	90	31.5	96 ± 10	8.5	7.3
Magnesium nitrate	Mg(NO <sub>3</sub> ) <sub>2</sub> ·6H <sub>2</sub> O	50	90	51.5	91 ± 14	11.6	9.6
Sodium chloride	NaCl	75	90	75	80 ± 25	15.2	12.8

<sup>1</sup> Wexler, Arnold, and Hasegawa, Saburo. Relative humidity-temperature relationship of some saturated salt solutions in the temperature range 0° to 50° C. Jour. Res. Natl. Bur. of Standards 53(1). Res. Paper 2512 794/19 801/26 pp., Washington: Govt. Printing Office. 1954.

See also: Spencer, H. M. Laboratory methods for maintaining constant humidity. International Critical Tables of Numerical Data Physics, Chemistry, and Technology. Vol. 1, pp. 67-68. New York: McGraw-Hill Book Co. 1926.

The relative humidity of the cabinets was brought to the desired percent before the fuel was put in place. The fuels had been predried in an oven at 125° F. for approximately 2 hours before being placed in the cabinets. A difference in stabilized moisture content of the fuel is found if the equilibrium point is approached from above or below ambient conditions. By oven-drying first, the equilibrium point of the fuel was always approached from the low moisture content side. This procedure was more important at the lower relative humidities.

Xylene distillation<sup>2</sup> was used to determine the equilibrium moisture content of each fuel. Two samples of fuel were taken from each cabinet, and a xylene determination of moisture content was made on each. When readings of fuel moisture content became consistent, the fuel was considered to have reached equilibrium with environmental conditions. The moisture content of most samples did not vary more than  $\pm 0.5$  percent daily after 1 week's conditioning. Fuel was then at a stable moisture content.

## FUEL LOADING

The fuel beds were prepared in a room having environmental conditions identical to those that existed in the conditioning cabinets. This prevented the moisture content from changing during fuel bed preparation.

Each fuel tray consisted of a  $\frac{3}{4}$ -inch asbestos board 24 inches wide by 8 feet long, with 3-inch-high wire mesh sides, indented 3 inches on each side. The fuel bed was 18 inches wide. The wire mesh sides were lined with paper to eliminate edge effects and thereby simulate an infinite-width fuel bed. The paper had been treated with saturated diammonium phosphate solution to prevent it from flaming and thereby influencing the rate of fire spread. Paper treated with diammonium phosphate will not burn but will char. The bottom of each tray was covered with aluminum foil with its reflective side up, and then with a layer of asbestos paper.

Compactness of the fuel beds<sup>3</sup> affects burning rate. Compactness of fuel loaded into large baskets for conditioning varies from top to bottom. This variation is caused by unavoidable shaking of the baskets during loading and unloading and also by normal settling of the fuel during conditioning. The longer needles are supported near the top whereas the shorter ones sift toward the bottom. This variation in compactness throughout the fuel must be considered in constructing reproducible fuel beds.

We devised a method of stratification to control compactness in each fuel bed. Needles from the conditioning baskets were weighed into small separate baskets, each containing 1 pound. The top layer of needles removed from any conditioning cabinet basket was divided and placed in three individual baskets, each containing 1 pound. The middle layer likewise was removed and divided equally among three baskets. The bottom 3-pound layer was divided the same way. Each fuel bed used in experimental burnings contained 6 pounds of needles, and three beds were usually burned in a day. Therefore, it was necessary to weigh out 18 baskets of conditioned needles from two conditioning cabinet baskets and then divide them into three groups according to whether they came from the top, middle, or bottom layer of the conditioning cabinet basket.

---

<sup>2</sup> Buck, C. C., and Hughes, John E. The solvent distillation method for determining the moisture content of forest litter. *Jour. Forestry* 37(8): 645-651. 1939.

<sup>3</sup> Anderson, Hal E., and Rothermel, Richard C. Influence of moisture and wind upon the characteristics of free-burning fires. *Tenth International Symp. on Combustion Proc.* 10 pp., illus. Cambridge, England, 1964.

We have developed the following procedure for building reproducible fuel beds having uniform compactness:

1. Random selection of one basket of needles from the six 1-pound baskets from the bottom layer of the two conditioning baskets.
2. Distribution of these needles in a small ridge along the middle of the first 4 feet of the fuel bed. (Workers wear gloves to prevent perspiration from affecting moisture content of the needles.)
3. Needles are worked outward toward sides of the tray until a uniform layer 1 inch deep is formed (fig. 2).
4. Repeat these operations for the other half of the fuel bed.
5. Random selection of two of the 1-pound baskets from the middle layer in the conditioning baskets.



Figure 2. --Preparation of a pine needle fuel bed.

6. Spreading these needles evenly over those already in the fuel bed to a total depth of 2 inches.

7. Similar selection and spreading of 2 pounds of needles from the top layer of the conditioning baskets.

8. Trimming with scissors any needles that protrude above the 3-inch height of the fuel tray.

Fuel beds constructed by this system produced very similar results. The graph (fig. 3) indicates the uniform burning rate of the fuel bed due to uniform fuel loading. The even burning rates also indicate the high degree of fuel bed reproducibility that was achieved.

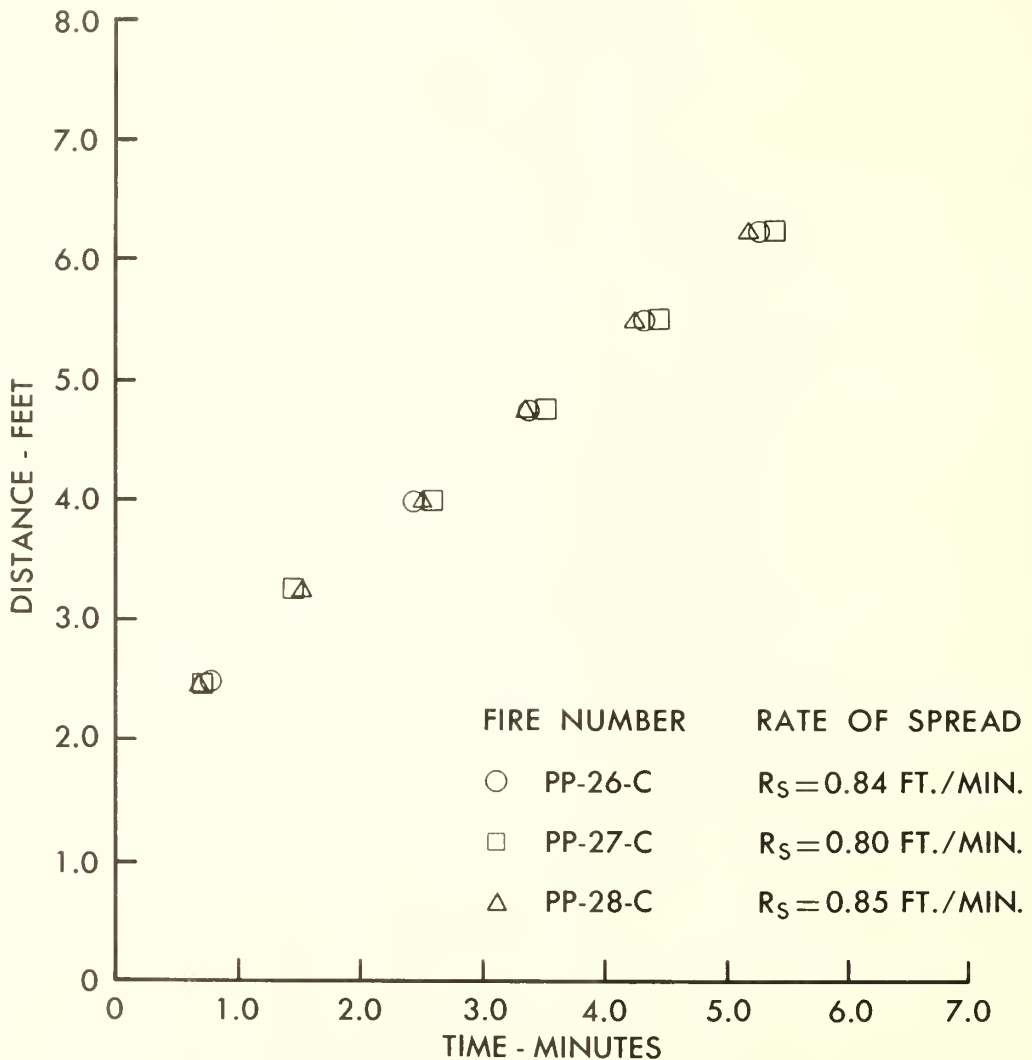

Figure 3. --Rate of spread of three fires in ponderosa pine needles.  
Relative humidity = 15 percent.  
Dry bulb temperature = 90° F.

During the past 3 years, more than 200 fuel beds prepared by this method have been burned.<sup>4</sup> This same method of fuel bed preparation was used in numerous experimental burns designed to evaluate effectiveness of various chemical fire retardants.<sup>5</sup>

## SUMMARY

Beds of pine needles for controlled experimental burnings should be constructed so as to provide reproducible burning conditions. Such fuel beds should be as free as possible from foreign matter (leaves, twigs, bark, and dust) and should have as uniform moisture content and compactness as possible.

To provide such reproducible burning conditions for experiments at the Northern Forest Fire Laboratory, fuel is collected from pure stands of the designated tree species and cleaned mechanically. It is then dried in ovens and conditioned to uniform moisture content in baskets in specially constructed vapor-sealed chambers equipped for circulating air over saturated solutions of specified salts. Needles thus prepared are divided according to whether they were in the top, middle, or bottom layer of conditioning baskets, and weighed into 1-pound units. These in turn are distributed evenly into corresponding 1-inch layers in the trays specially constructed and prepared for controlled burning.

---

<sup>4</sup>Anderson, Hal E. Mechanisms of fire spread, research progress report No. 1. U.S. Forest Serv., Intermountain Forest & Range Expt. Sta. Res. Paper INT-8, 20 pp., illus. 1964. (See also Anderson and Rothermel, op. cit.)

<sup>5</sup>Hardy, Charles E., Rothermel, Richard C., and Davis, James B. Evaluation of forest fire retardants--a test of chemicals on laboratory fires. U.S. Forest Serv., Intermountain Forest & Range Expt. Sta. Res. Paper 64, 33 pp., illus. 1962.





# Research Note

UNITED STATES DEPARTMENT OF AGRICULTURE  
FOREST SERVICE

INTERMOUNTAIN FOREST & RANGE EXPERIMENT STATION  
OCDEN UTAH



U.S. Forest Service  
Research Note INT-37

1965

## LOW AIRSPEED DIFFERENTIAL PRESSURE INTEGRATING SYSTEM

Richard C. Rothermel, Aeronautical Research Engineer  
Division of Forest Fire Research

### ABSTRACT

An instrument system for measuring small differential pressures in turbulent airstream flow can also measure airstream velocities within boundary layers, convection columns, and wind tunnels when turbulent flows range between 1 and 25 mph.

This paper describes an instrument system now used to measure small differential pressures in turbulent airstream flow. This system was developed to determine the velocity profiles in the low-speed wind tunnels at the Northern Forest Fire Laboratory at Missoula, Montana.

The system has also been useful for measuring velocities within boundary layers, convection column velocities, average wind tunnel velocity, and pressure drop across an orifice plate. These velocities have been measured in turbulent flows at speeds ranging from 1 to 25 mph.

### DESIGN APPROACH

Measuring velocity profile by means of differential pressure ( $\Delta p$ ) is not new. However, measuring such profiles at speeds less than 5 mph presents serious problems of instrument sensitivity and repeatability.

To achieve accuracy of 1 percent of the reading at 1.5 mph, the range of the measuring system must extend to approximately  $2 \times 10^{-5}$  inches of water. This precision cannot be achieved with instantaneous readout in turbulent airflow because the difference in total pressure,  $\Delta p_T$ , between two points may oscillate through zero and thus produce an ambiguous reading. The time average value of  $\Delta p_T$  does have a definite or repeatable value and may be obtained by integrating the fluctuating signal. In this system, a resistance capacitance circuit with a time constant of approximately 2.5 minutes performs the integration.

The difference in velocity between two points expressed as a fraction of free-stream velocity can be calculated from the difference in total pressure between the two points and the free-stream dynamic pressure with the formula:

$$\frac{v_2 - v_1}{v_o} = -1 + \sqrt{1 + \frac{(p_{T2} - p_{T1})}{q_o}} \quad (\text{Eq. 1})$$

where:

- $v_1$  = air velocity at center of tunnel
- $v_2$  = air velocity at any other point in the same cross-sectional plane
- $v_o$  = free-stream average velocity
- $p_{T1}$  = total pressure at center of tunnel
- $p_{T2}$  = total pressure at any other point in the same cross-sectional plane
- $q_o$  = free-stream dynamic pressure.

Several characteristics of the differential pressure ( $\Delta p$ ) method enhance its value for measuring air velocity. When making a velocity profile calibration, the differences in absolute velocity or total pressure between a reference point and a point in the test section must be obtained. Absolute measurements of velocity yield large numbers, which can cause inaccuracies since the differences in velocity may be smaller than can be measured accurately by instrument. However, a differential pressure measuring system automatically provides the difference in total pressure; hence, values obtained from it can be used in equation 1.

Another source of error inherent in devices for measuring absolute velocity, such as hot wire anemometers and rotating vanes, is drift of the average air velocity during the measurement. When measuring the differential pressure,  $\Delta p$ , drift of the average velocity has little effect on the ratio of  $\frac{\Delta p}{q}$  where  $q$  is the dynamic pressure. Another advantage of the differential pressure system is its capability of being statically calibrated against a physical standard. In contrast, systems that measure air velocity directly must be calibrated in an airstream of known flow conditions. Operation of the differential pressure system has shown the data to be repeatable even after shutdown and restart of airflow through the wind tunnel. An example of data taken by this system at 1.5 mph is shown in figure 1.

The maximum differential pressure that can be measured by the system described here is 0.3 inch of water. This capacity is limited by the differential transducer. The minimum range is limited by the turbulence in the airstream and the drift of the integrator. Our experience indicates the minimum range is about  $2 \times 10^{-5}$  inches of water. Calibration of the transducer shows a linear relation of output voltage to input pressure. Integrated readings can be repeated every 3 to 4 minutes unless the preceding measurement heavily charges the capacitors in the integrator. Capacitors are self-charging; when heavily loaded, they require additional time to decay to an acceptable value. For this reason the dynamic pressure,  $q$ , for velocities greater than 2 mph should be read directly and not integrated.

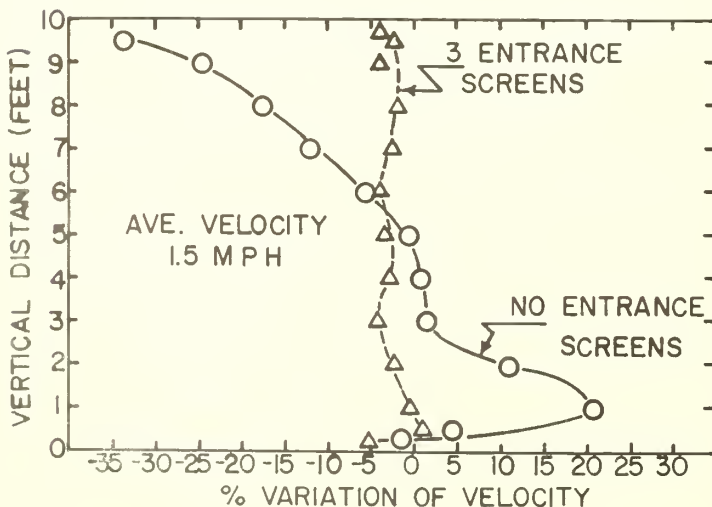

Figure 1.--Typical velocity profiles made in low-speed wind tunnel by the system described in this paper.



## DESCRIPTION OF THE SYSTEM AND ITS COMPONENTS

The differential pressure measuring system now used at the Northern Forest Fire Laboratory (fig. 2) contains all of the components necessary for measuring low differential pressures, and includes a means of static calibration of the measuring components. These components and their functions are described below.

Probes. -- Total pressure or Kiel probes measure  $p_{T1}$  and  $p_{T2}$ . The reference pressure probe,  $p_{T1}$ , is fixed at one location, normally the longitudinal centerline of the wind tunnel. The other probe,  $p_{T2}$ , is moved to the desired positions.

The dynamic pressure,  $q$ , is measured by a pitot-static probe located at the same wind tunnel cross section as the Kiel probes. The pitot-static probe should be located away from the tunnel walls but need not be in the center.

The size of the probes to be used depends somewhat on the velocity of the air and on the amount of air turbulence to be measured. For measuring velocities greater than 5 mph, size of the probe is not critical; but at speeds slower than 5 mph, good results were obtained by using Kiel probes made from  $\frac{1}{4}$ -inch copper tubing with a  $\frac{1}{2}$ -inch hood. Commercial probes are also suitable.

Snubbers. -- A simple snubber may be used to dampen the pressure fluctuations in the tubes coming from the probes to the pressure switching box. Pinhole snubbers made from tubing connectors and masking tape are satisfactory. One or two snubbers in each line have proved satisfactory.

Pressure switching box. -- The pressure switching box (figs. 3 and 4) is divided into high and low pressure sides and has high and low pressure manifolds to accept the input pressure lines. Each manifold is connected to the corresponding input post of the pressure transducer. An interconnecting line and an on-off

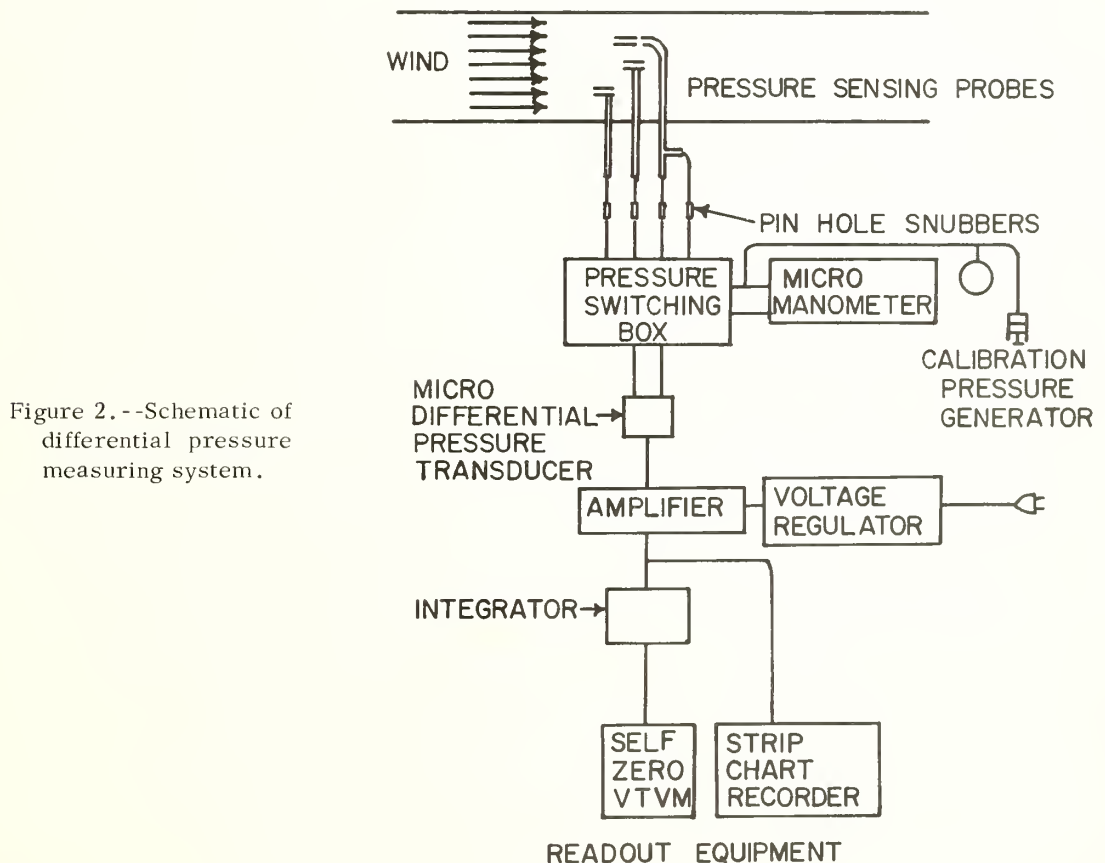

valve are placed between the two manifolds. When open, the valve equalizes the pressure between the two manifolds and is used to zero the output of the transducer. The pressures are switched with on-off toggle valves. The input lines are attached with quick-disconnect plastic fittings.

Microdifferential pressure transducer and amplifier. --The transducer and amplifier (figs. 2 and 5) convert the differential pressure into an electrical signal. The transducer should be placed on a rigid table that will not yield under elbow pressure. Our system used a Decker Model 306-2F Transducer and Amplifier,<sup>1</sup> but equivalent equipment probably would be satisfactory. This transducer is a "no-flow" type that reduces the effect of line length and snubbers and prevents contaminated gases from reaching the transducer. The signal may be read directly on the amplifier meter or may be taken from the output jack to strip chart recorders or to an integrator. The 115-volt, 60-cycle power for the amplifier must be regulated.

Integrator. --The integrator box (figs. 5 and 6) contains the electrical components and switches needed to integrate the signal or to bypass it directly to the readout equipment. The time constant for a 5-megohm resistor and 25.5-microfarad capacitor is 2.12 minutes, but may vary with the components used. In operation, signals are integrated for 2 minutes.

Readout meter. --A self-zeroing high input impedance (10 megohm) vacuum tube voltmeter (fig. 5) with a minimum sensitivity of 1 mv full scale is required for readout of the integrated signal. A digital voltmeter probably could be substituted in this application, but a needle meter has been satisfactory. A center zero meter would be desirable, but a two-position + or - switch is adequate. Our system uses a Hewlett Packard Model 412 A. An equivalent meter would be satisfactory.

Calibration system. --A commercial micromanometer (fig. 4) is connected through the switching box to the pressure transducer. Our system uses a Flow Corporation Model MM 3. An equivalent manometer would be satisfactory. A plastic syringe in the high-pressure side of the system provides an adjustable positive pressure for both the micromanometer and the pressure transducer. A lead screw is attached to the plunger of the syringe for adjusting pressure slowly. A bottle is placed in the line to decrease sensitivity of the syringe.

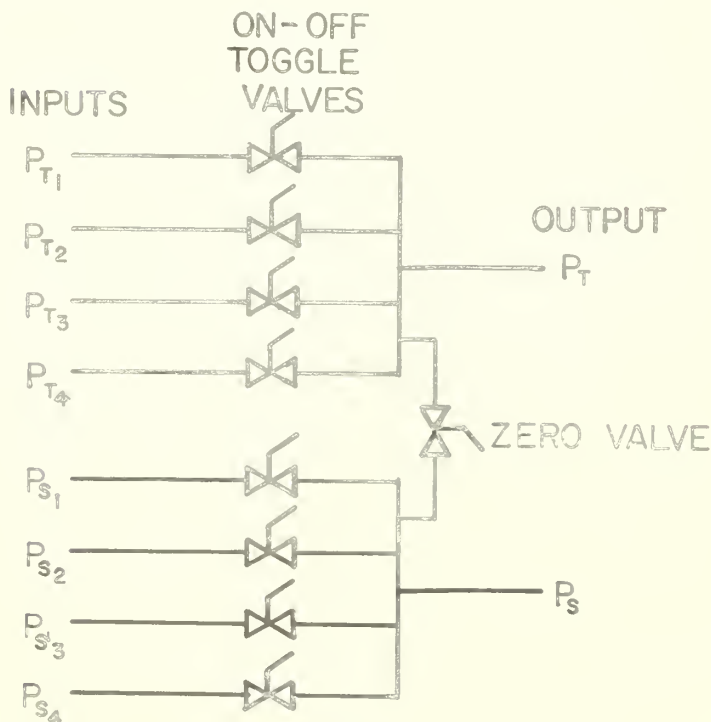

Figure 3.--Schematic of pressure switching box.

<sup>1</sup> Brand names of equipment are used only for identification and do not constitute endorsement by the Forest Service.

It has not been possible to calibrate the system with less than  $3 \times 10^{-3}$  inches of water because a pressure less than this cannot be maintained for the required 2-minute integration period. The calibration curve (fig. 7) is linear through the calibration range and can be extended through zero. Calibration procedures are listed on page 7.

### TROUBLEMAKERS

Measurement of weak signals requires certain precautions to prevent erroneous readings. Examples of sources of disturbances are listed below, with directions for obtaining best operation.

Electrical power fluctuations.--This point has already been mentioned but is reemphasized here. The electrical power source for the amplifier must be regulated for best performance of the equipment. Either transformers or electronic regulators can regulate power adequately.

Vibration.--The transducer and micromanometer must be placed on a heavy laboratory table. All pressure lines should be stable and free from oscillation when readings are taken.

Tubing routes.--Tubes should be kept as short as possible and should be kept close to each other so that they will be at the same temperature. Keep them away from lights that would heat the air inside only one tube. Avoid unnecessary vertical runs. A vertical tube that is at a different temperature from its mate will cause a serious error.

Temperature.--Most pressure transducers or their amplifiers are sensitive to temperature. Avoid installation in drafty rooms where temperature fluctuates frequently. Temperature of the airflow should be constant; otherwise, temperature corrections will be necessary.

Figure 4.--Pressure calibrating system.

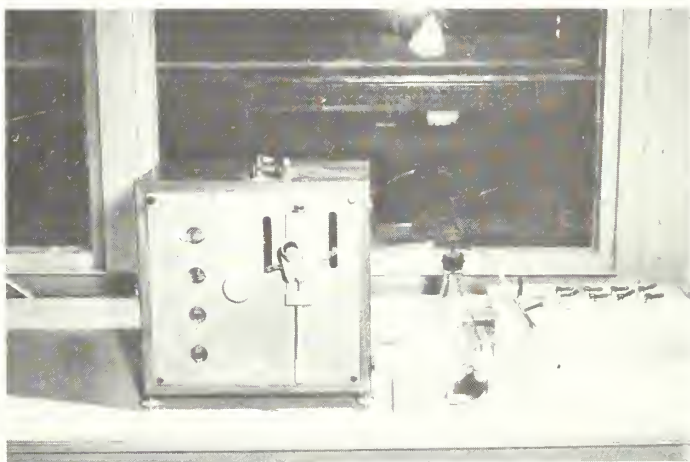

Figure 5.--Electrical pressure measuring equipment. From right to left: transducer, amplifier, integrator, strip chart recorder, and vacuum tube voltmeter.



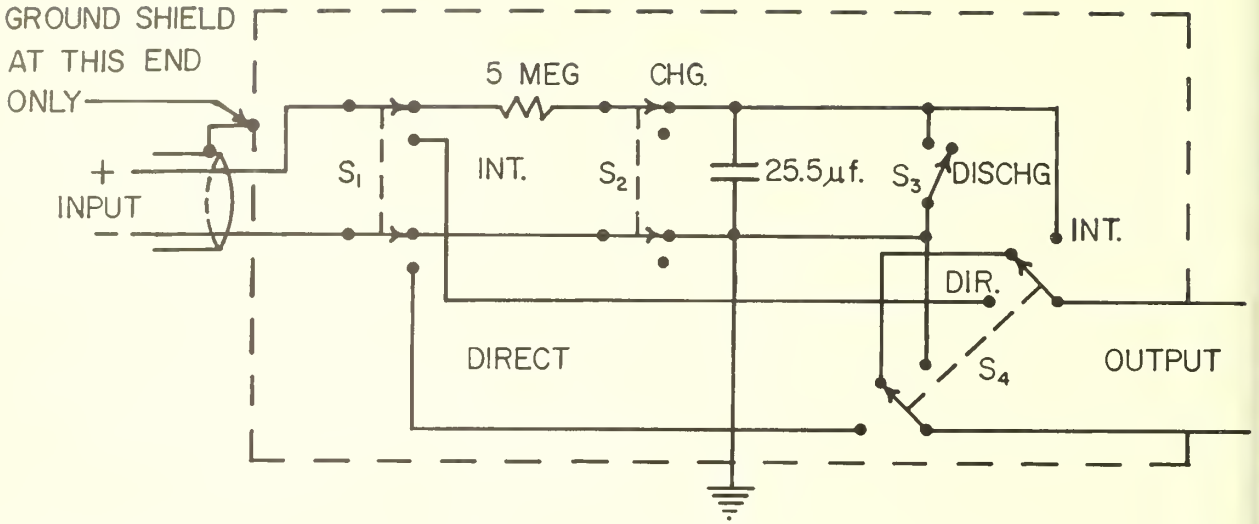

Figure 6. --Schematic of signal integrator.

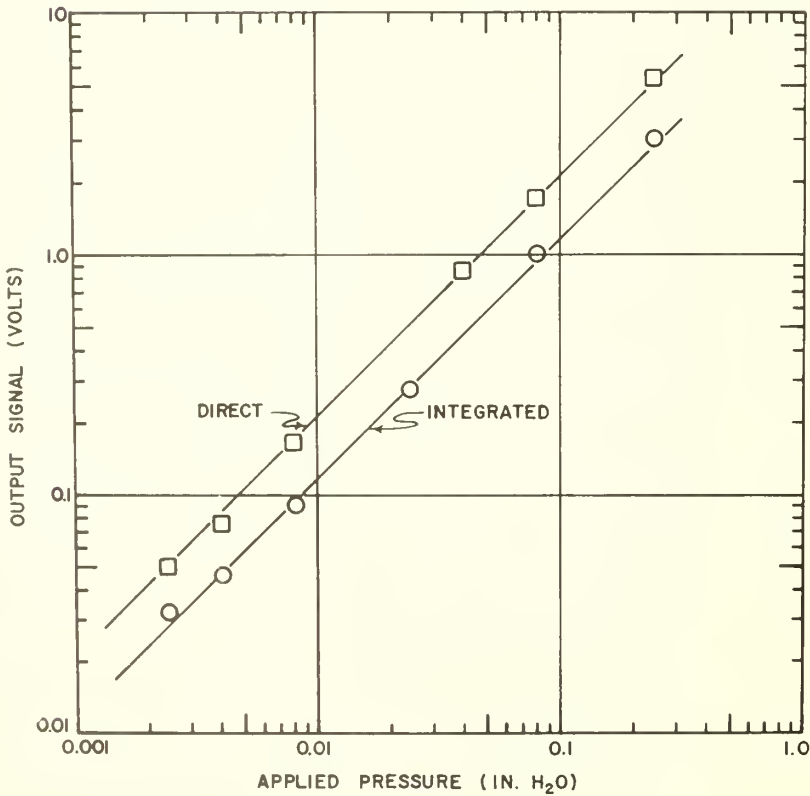

Figure 7. -- Calibration curves for integrated or direct signal.

## OPERATING PROCEDURES FOR WIND TUNNEL CALIBRATION

### warmup

Turn on transducer, amplifier, and output meter. Allow manufacturer's specified warmup time.

### calibration

1. On pressure switching box, open valves connecting micromanometer to transducer. Also open the zero valve.
2. Switch amplifier to most sensitive range and adjust amplifier meter to zero. Return amplifier range switch to "output" position.
3. Adjust micromanometer to zero.
4. Close zero valve on pressure switching box.
5. Using syringe, slowly increase pressure on transducer and micromanometer to 0.1 inch of water or whatever fluid the micromanometer contains.
6. On the integrator box, place the mode switch S 1 and the readout switch S 4 in "direct" position.
7. Read the output meter.
8. Using the following formula, calculate the calibration constant (C.C.). The specific-gravity correction relates the length of the column of manometer fluid to inches of water and is usually adjusted for the temperature of the fluid.

$$C.C. = \frac{\text{Voltage on meter}}{(0.1) \text{ (specific-gravity correction)}} = \frac{\text{Volts}}{\text{inches H}_2\text{O}}$$

### Setting air velocity

1. For the desired wind tunnel speed, compute the corresponding dynamic pressure, q, by the formula:

$$q = \frac{\rho v^2}{2g} \times 0.1922$$

where: q = dynamic pressure--inches H<sub>2</sub>O

ρ = air density--lb/ft<sup>3</sup>

v = air velocity--ft/sec

g = acceleration gravity--ft/sec<sup>2</sup>

0.1922 = conversion from lb/ft<sup>2</sup> to inches H<sub>2</sub>O.

2. Multiply the desired dynamic pressure by the calibration constant to determine the voltage necessary for the desired velocity on the output meter.
3. On the pressure switching box, close the switches to the micromanometer and open the switches to the total-static tube. Close the zero switch.
4. With the integrator box switches still set for direct readout, observe the reading on the output meter. Adjust the air velocity until the output meter indicates the value of q calculated in step 2. The tunnel is now operating at the correct velocity, and calibration can begin.

### Discharge capacitor

Note: The discharge switch S 3 should always be left in the closed position between readings.

1. On the pressure switching box, close all input switches and open the zero switch.
2. On the amplifier, re-zero the meter.
3. On the integrator, the discharge switch S 3 should be closed. Put the readout switch S 4 on "integrate," open the charge switch S 2, and put the mode switch S 1 on "integrate."

4. Open the discharge switch S 3 and increase the sensitivity of the readout meter until the needle comes u scale. It may be necessary to change polarity of the meter.

5. Observe the readout meter. If the integrator capacitor is discharged, the meter will remain stationa near zero mv and should be less than 0.1 mv. If the needle drifts, the capacitors are not discharged or the amplifier output is not zero.

6. To discharge the capacitors, close the discharge switch S 3 and open it again. After this has been repe several times, the needle should remain stationary unless a large charge was previously on the capacitor--in wh case more time will be necessary.

7. When the capacitors are discharged, the charge switch S 2 may be closed and the discharge switch S 3 opened. If the amplifier is truly zeroed, the output meter will remain stationary near zero  $\pm 0.1$  mv.

8. If the amplifier has drifted, it may be set more accurately by switching the integrator to direct read and zeroing the amplifier on the readout meter.

9. When you are satisfied that the capacitor is discharged and the amplifier is at zero, close the dischar switch S 3 and prepare to integrate the desired signal without delay.

### Integrating a signal

1. Choose the pressures to be integrated, either  $p_{T0}-p_{S0}$  or  $p_{T2}-p_{T1}$ , on the pressure switching box. Clo the zero valve.

2. On the integrator box, both the discharge switch S 3 and charge switch S 2 should be closed. The me switch S 1 should be on "integrate" and the readout switch S 4 should be grounded.

3. Approximately 30 seconds after the zero valve has been closed (step 1), open the discharge switch S 3 1 start a stopwatch at the same time.

4. When the stopwatch reaches 2 minutes, throw the readout switch S 4 to the "integrate" position and o serve the readout meter. Record this reading after the first swing of the needle has stopped. Note that the capa tor will continue to charge slowly because the charge switch is still closed. If desired, the charge switch may e opened at the end of 2 minutes.

5. After recording the reading (step 4), close the discharge switch S 3 and open the charge switch S 2. O the zero valve on the pressure switching box, and close the pressure selecting valves. Discharge the capacitor outlined in the section above.

### Measuring dynamic pressure

If the wind tunnel holds a constant air velocity over long periods and the amplifier does not drift, the dyna pressure need be read only every 2 to 3 hours.

For low velocities (1.5 to 2 mph), the dynamic pressure  $p_{T0}-p_{S0}$  may be integrated as outlined above. F higher velocities, the signal for dynamic pressure will charge the capacitor to a value that will cause excessi discharge time. To prevent this, the signal may be read directly on the output meter, and the integrated value n be calculated for use in data reduction. To do this, of course, the ratio of integrated/direct reading must be fo for a 2-minute integrated reading. This can be done easily with the calibration system. For our system, the r for integrated/direct = 0.576. This ratio will be different for each integrator. This ratio may also be used w setting the wind tunnel velocity at low speeds where it is desirable to integrate q to check the velocity.

When measuring any pressure, it is wise to take at least three readings and to check each one against t others. If the readings repeat well, the airflow fluctuations are consistent and the average should be used. If c reading is markedly different from the others, something may have caused a bad reading, or the air velocity m have a cyclic pattern that causes the average velocity to change with time. If consistent readings cannot be o tained at the same location, the airflow may be too turbulent to measure and damping screens should be installe in the mouth of the wind tunnel.



# Research Note

UNITED STATES DEPARTMENT OF AGRICULTURE  
FOREST SERVICE

INTERMOUNTAIN FOREST & RANGE EXPERIMENT STATION  
OGDEN UTAH

U.S. Forest Service  
Research Note INT-38

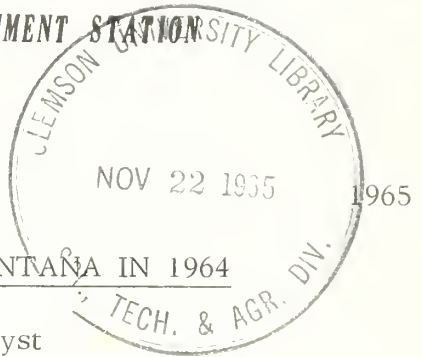

## EXPORT OF CHRISTMAS TREES FROM MONTANA IN 1964

Robert E. Benson, Marketing Analyst

### ABSTRACT

Truck and rail shipments of Christmas trees from Montana in 1964 totaled only 2 million, the smallest number since 1942. This paper discusses improved quality of exported trees, notes damage by insects and disease, and compares volume of 1964 shipments with that of selected earlier years.

Shipments of Christmas trees from Montana in 1964<sup>1</sup> totaled only some 2 million trees, a decrease of 5 percent from shipments in 1963.<sup>2</sup> This decline continued the general downward trend that started in 1957 after record-breaking shipments of 4.2 million trees in 1956.<sup>3</sup> In 1964, Montana exports were 4.9 percent of the estimated total Christmas tree consumption in the United States, compared with 10.6 percent in 1948 and 8.6 percent in 1955.

<sup>1</sup>This report deals only with shipments of trees to markets outside Montana. Consumption within the State is estimated at 160,000 trees. Each interstate railway line supplied data for trees shipped by rail; the State Forester and National Forests supplied figures on truck shipments.

<sup>2</sup>Spencer, John S., Jr. Montana Christmas tree exports reach lowest level since survey was begun in 1942. U.S. Forest Serv., Intermountain Forest and Range Expt. Sta. Res. Note INT-24, 4 pp., illus. 1964.

<sup>3</sup>Wilson, Alvin K. A new high in Montana Christmas tree shipments. U.S. Forest Serv., Intermountain Forest and Range Expt. Sta, Res. Note 44, 4 pp., illus. 1957.

Damage caused by insects and diseases has accompanied this general downward trend. Although it continued to plague producers in 1964, the quality of trees was reported to be the best in recent years in the more important producing areas. This improvement may result from stricter grading and from the demand for higher quality trees. New damage from insects and disease appears to have decreased in some areas, but the incidence of these pests varies by locality.

Continued heavy damage from Douglas-fir needle midge and needlecast (Christmas tree blight) was reported in the Libby area. Flathead County reported very little needlecast damage, but forest pathologists found the disease very prevalent in certain areas of the Bitterroot Valley and in the vicinity of Flathead Lake. They also pointed out that the cool, wet spring and summer of 1964 favored the spread of needlecast disease, and may have resulted in heavy new infection that will not be detected until the 1965 surveys begin.

Damage from defoliation by the spruce budworm continued over an extensive area of the State, principally in Douglas-fir stands. Aerial surveys of visible damage indicated a decrease in defoliation in some areas, notably the Bitterroot and Deerlodge National Forests, but an increase in defoliation in the Helena, Lewis and Clark, and Beaverhead National Forests. The total area of budworm defoliation in the State was approximately 2 million acres, about the same as in 1963.

Shipments from Lincoln County increased 7 percent over those for 1963. Lincoln County thus became the leading producer in 1964 with a total export of 937,000 trees. Shipments from Sanders and Lake Counties increased by more than 20 percent over 1963 levels, and exports from Granite County increased substantially.

These increases were more than offset by decreased shipments from Flathead County, the leading producer in 1963. Shipments from Flathead County in 1964 were 672,000 trees, down 230,000 from 1963. In addition, shipments from Missoula County declined about 50 percent from 1963 volume.

Rail shipments were slightly higher in 1964, and thus reversed the downward trend for several preceding years. Shipments to Texas, Oklahoma, Missouri, and Kansas were notably higher than in 1963. However, shipments to California dropped sharply, and Iowa and Nebraska, two other leading consumers, also received fewer rail-shipped trees from Montana in 1964. Truck shipments declined by about 100,000 trees from 1963.

Exports of Christmas trees from Montana have declined, but total consumption of Christmas trees in the United States increased substantially through 1962. Insect and disease damage, which reduces the number of high quality trees available for harvest in natural stands, has probably contributed to the decline in Montana exports.

Another factor that may significantly influence Christmas tree exports from Montana is the increasing competition wild-grown trees face in national markets. This



competition is chiefly of two sorts: trees grown in plantations, and artificial trees. It has been estimated that trees grown in plantations, which are often pruned to produce good form and quality, accounted for 44 percent of the Christmas trees purchased in the United States in 1964.<sup>4</sup>

In addition, many families are buying artificial Christmas trees. One recent study indicated that about one out of five Utah families used artificial trees in 1964.<sup>5</sup> Buyers cited attractiveness, economy, and convenience as important reasons for purchasing artificial trees. These changing market conditions may well account for some of the decline in Montana exports, but as yet we have no definite data to confirm this speculation.

<sup>4</sup>Correspondence with A. M. Sowder, Federal Extension Service, U.S. Dept. of Agriculture.

<sup>5</sup>Hunt, John O., and William D. Poulsen. Impact of artificial Christmas trees on the Utah Christmas tree market. Farm and Home Science. March 1965. Agr. Expt. Sta., Utah State Univ., Logan, Utah.

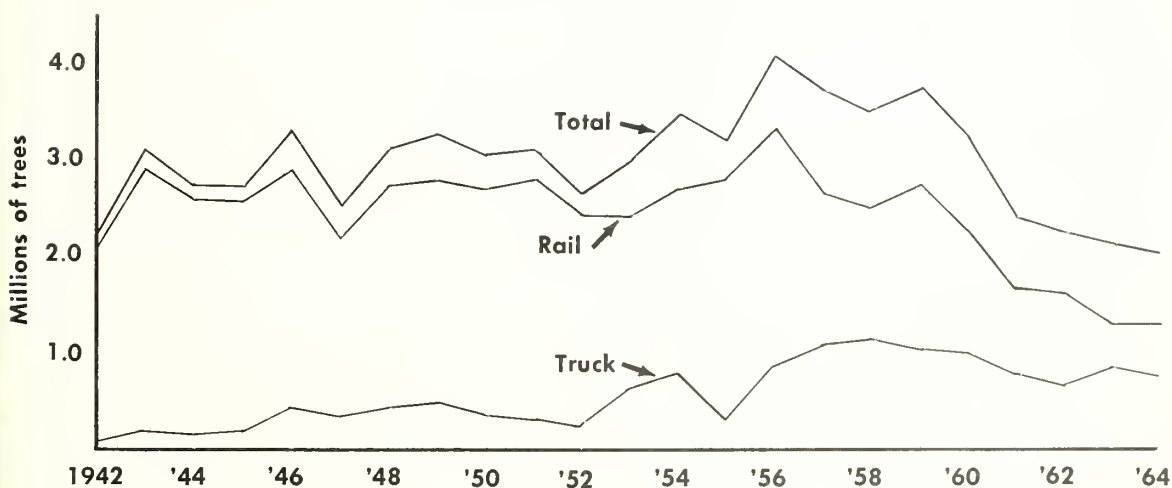

Figure 1.--Shipments of Christmas trees from Montana, 1942-1964.

Table 1.--Shipments of Christmas trees by rail and truck from Montana, by counties, 1964 and 1963

County	1964			1963		
	Rail	Truck	Total	Rail	Truck	Total
	----- Thousands of trees -----					
Lincoln	523	414	937	556	316	872
Flathead	456	216	672	465	437	902
Lake	181	5	186	147	6	153
Sanders	109	22	131	76	30	106
Granite	--	32	32	--	3	3
Missoula	14	13	27	38	15	53
Other	10	11	21	5	11	16
Total	1,293	713	2,006	1,287	818	2,105

Table 2.--Rail shipments of Montana trees to principal markets by States, 1964 and 1963

State	1964		1963	
	Thousands of trees	Percent	Thousands of trees	Percent
Texas	385	30	328	25
Oklahoma	195	15	171	13
Missouri	142	11	128	10
Kansas	142	11	114	9
California	104	8	161	13
Iowa	76	6	109	8
Louisiana	66	5	47	4
Nebraska	48	4	62	5
Other	135	10	167	13
Total	1,293	100	1,287	100

Table 3.--United States consumption and Montana exports of Christmas trees, selected years

Year	Total U.S. consumption <sup>1</sup>	Montana exports	Montana exports as percent of U.S. consumption
	----- Thousands of trees -----		
1948	29,383	3,123	10.6
1955	37,791	3,235	8.6
1960	42,050	3,200	7.6
1962	43,487	2,249	5.2
1964	40,925	2,006	4.9

<sup>1</sup> Data for 1948-1962: Sowder, A. M. Christmas tree data for 1962. Jour. Forestry 61: 869-871. Data for 1964 from correspondence (text footnote 4).



# Research Note

UNITED STATES DEPARTMENT OF AGRICULTURE  
FOREST SERVICE

INTERMOUNTAIN FOREST & RANGE EXPERIMENT STATION  
OGDEN UTAH

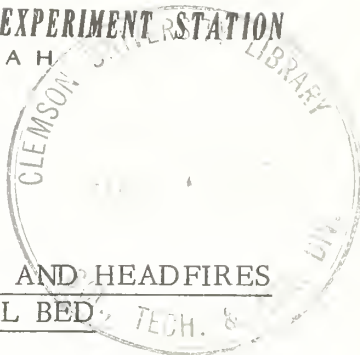

1965

U.S. Forest Service  
Research Note INT-39

## CHARACTERISTICS OF BACKFIRES AND HEADFIRES IN A PINE NEEDLE FUEL BED

William R. Beaufait<sup>1</sup>

### ABSTRACT

Burning characteristics of backfires, headfires, and no-wind fires in fuel beds of ponderosa pine needles were compared at the Northern Forest Fire Laboratory. Data gathered under controlled laboratory conditions indicate that fires backed into the wind (backfires) consistently burn slower, longer, and deeper than fires burned with the wind (headfires). In this investigation, increasing air velocity had a marked effect on headfires, but did not significantly change the rate of spread and other burning characteristics of backfires. Field studies are needed to establish more conclusively the differing capabilities of headfires and backfires in preparing seedbeds and planting sites.

Fires in natural forest fuels exhibit different characteristics when backing against the wind or downslope than when heading with the wind or burning upslope. Forest managers using prescribed fire for site preparation and hazard reduction use both headfires and backfires to burn slash after timber harvest operations. They frequently adjust ignition patterns to utilize both the slow-burning features of backfires for hazardous block edges, and the rapid rate of spread of headfires for internal areas.

---

<sup>1</sup> Physicist, Intermountain Forest and Range Expt. Station, Northern Forest Fire Laboratory, Missoula, Montana.

Because headfires and backfires spread at different rates, it is reasonable to assume that their other characteristics also vary. For example, the author, while burning for jack pine regeneration in Michigan, observed that backfires usually burned deeper into the duff under jack pine slash than headfires did.<sup>2</sup> However, published reports of comparisons of temperature and duration are not always consistent. One report<sup>3</sup> found that temperatures of backfires were significantly higher than temperatures of headfires up to a height of about 18 inches above burning longleaf pine needle and grass fuels. Both kinds of fire reached a maximum temperature about 5 inches above the ground. Conversely, another study<sup>4</sup> recorded temperatures of headfires 1 foot above the ground in natural gallberry-palmetto fuels that were two to six times greater than backfire temperatures at the same height. Measurements by Fahnestock and Hare<sup>5</sup> on the bark of trees over burning longleaf pine needles showed backfire and headfire temperatures of both types of fire were equal near the ground; but headfires became much hotter 1 foot and more above ground line.

Users of prescribed fire need more definite information about the burning and site-preparation characteristics of both backfires and headfires. Any such comparison should first be made in a carefully controlled environment. For this reason, in 1965, researchers at the Northern Forest Fire Laboratory burned a series of fuel beds of ponderosa pine needles. The study included headfires and backfires burned in a wind tunnel at comparable windspeeds, fuel moistures, and temperatures, and no-wind fires burned in a combustion chamber. This paper compares the data taken from 15 backfires with data collected earlier in the study by Rothermel and Anderson<sup>6</sup> from 25 headfires and from 12 fires burned in the absence of wind.

## PROCEDURES

Backfires were burned in uniform fuel beds of ponderosa pine needles 18 inches wide, 8 feet long, and 3 inches deep, using procedures and instrumentation described by Rothermel and Anderson.<sup>7</sup> Free airstream velocities were  $1\frac{1}{2}$ , 3, 5, and 8 miles per hour. Fuel moisture of the needles was in equilibrium with the environment at the time of burning. Fuel moisture was 8 percent at a dry bulb temperature of 90° F. and a relative humidity of 47 percent. A narrow tray of flaming alcohol at the lee edge of the fuel bed assured uniform ignition.

---

<sup>2</sup>Beaufait, W. R. Procedures in prescribed burning for jack pine regeneration. Michigan Col. Mining and Technol. Tech. Bul. 9, 39 pp. 1962.

<sup>3</sup>Lindenmuth, A. W., and G. M. Byram. Headfires are cooler near ground than backfires. U.S. Forest Serv. Fire Control Notes 9(4): 8-9. 1948.

<sup>4</sup>Davis, L. S., and R. E. Martin. Time-temperature relationships of test headfires and backfires. U.S. Forest Serv. Fire Control Notes 22: 20-21. 1961.

<sup>5</sup>Fahnestock, G. R., and R. C. Hare. Heating of tree trunks in surface fires. Jour. Forestry 62: 799-805. 1964.

<sup>6</sup>Rothermel, R. C., and H. E. Anderson. Fire spread characteristics determined in the laboratory. (In preparation.)

<sup>7</sup>Ibid.

Thermocouples located at the surface of the fuel measured the rate of spread and duration of flaming. A strain-gauge weighing system monitored fuel loss throughout each fire. Flame dimensions were photographed as the flame front passed each  $\frac{1}{2}$ -foot interval along the fuel bed.

Fires were replicated three times at each of the four wind conditions, and one additional bed was burned at each of the three lowest windspeeds.

## RESULTS

The most important burning characteristics of the backfires are summarized in table 1. Analysis of variance for each characteristic shows no statistical differences attributable to changes in windspeed. The remarkable uniformity in rate of spread, residence time, flame depth, and weight loss recorded in this study suggests that fires backing into the wind may be expected to behave alike, regardless of air velocity. The only observed difference among backfires was a progressively greater flame angle from the vertical as velocity increases.

Table 1. - Burning characteristics of backfires with different air velocities<sup>1</sup>

Air velocity m.p.h.	:	Number of fires	:	Mean rate of spread	:	Mean residence time	:	Mean flame depth	:	Mean weight loss
				<u>Ft./min.</u>		<u>Min.</u>		<u>Ft.</u>		<u>Lbs./min..</u>
1.5		4		0.50		1.96		0.96		0.40
3		4		.51		2.02		1.05		.39
5		4		.49		2.40		1.14		.39
8		3		.50		2.03		1.02		.36
Calculated "F" <sup>2</sup>				1.14		1.19		0.41		0.62

<sup>1</sup>Rate of spread, residence time, and flame depth were determined by temperature records from 12 thermocouples in each fire. Weight loss was recorded after the fires attained a steady rate of spread.

<sup>2</sup>Table "F".05" = 3.59 with 3 and 11 degrees of freedom.

Striking contrasts appear when we compare the backfire data with the results obtained previously from headfires and burning in the absence of wind. Figures 1-5 graphically express burning and flame characteristics over a continuous scale of air velocity from minus 8 (backfire) to plus 8 miles per hour (headfire).

1

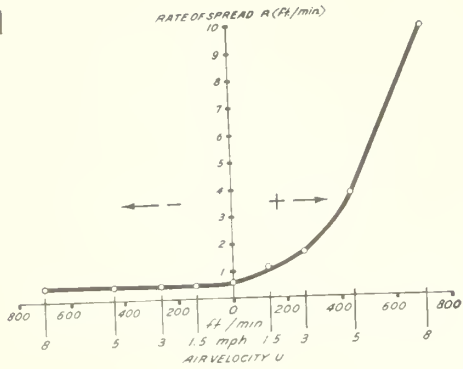

2

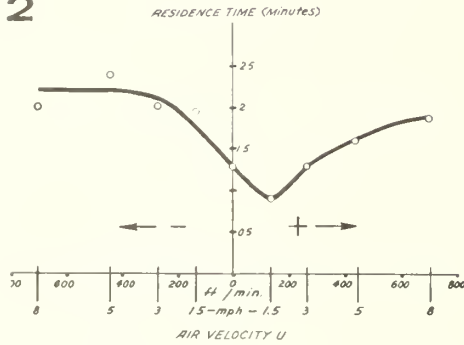

Figures 1-5.--Fire parameters are plotted against air velocity. Values to the left of zero are for backfires; those to the right of zero are for headfires.

3

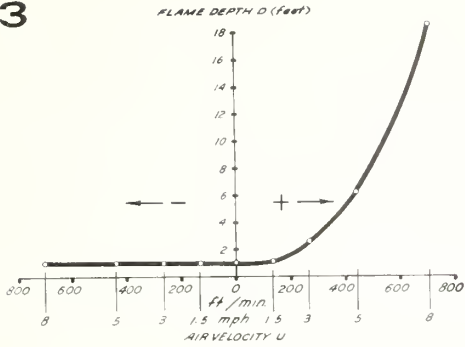

4

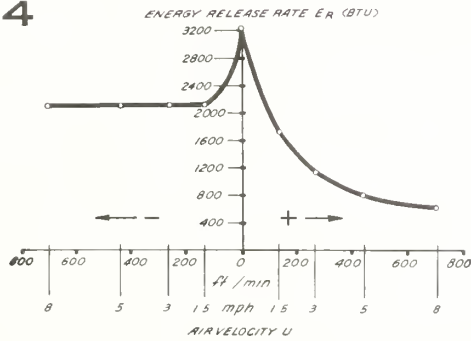

5

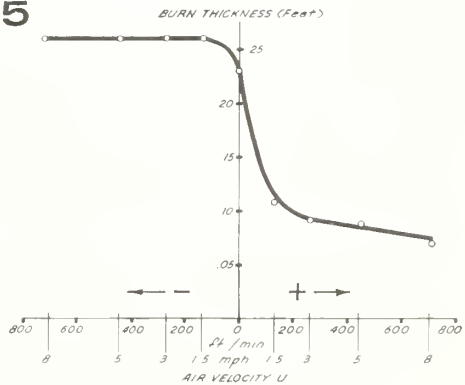

Rate of spread.--This characteristic is low in backfires and no-wind fires, but high in headfires. Rate of spread for headfires is an exponential function of positive air velocity. It is probably influenced by radiant preheating from flames leaning over unburned needle fuels. As air velocity increases, flames of a headfire lean progressively closer to unburned fuels, and at the same time lengthen to cover 1 to 4 feet of the fuel bed ahead of the moving front. Under no-wind conditions, the flame is generally perpendicular to the fuel bed, and radiant preheating is greatly reduced. Flames at the leading edge of a backfire actually lean away from unburned fuels.

Since a flame front radiates as the cosine function of the angle from its surface, flames of backfires and no-wind fires do not preheat unburned fuels as headfires do. Indeed, the flow of air over unburned fuels probably cools the leading edge of backfires. The consistent rate of spread of backfires, regardless of air velocity, strongly suggests that flame propagation results from preheating and ignition mechanisms at work beneath the surface of the fuel bed.

Residence time.--Residence time of the fires, or the duration of flaming at a given point on the fuel bed, varies with the change from negative to positive air velocity (fig. 2). The residence time of backfires is not greatly affected by air velocity. Backfires spread more slowly than headfires, they burn longer in place, and, in this instance, they completely consumed the fuel beds. Residence time is difficult to measure when, as in the case of no-wind fires and headfires, fuels are not completely consumed by the fire (see Burn thickness below). For this reason, variation in residence time between no-wind fires and headfires cannot be satisfactorily explained.

Flame depth.--Since rate of spread and residence time are uniform for backfires, it follows that flame depth, or dimension of the flame parallel to its direction of movement, does not vary with air velocity. However, flame depth of headfires increases at an exponential rate. Figure 3 shows this relation, with backfire flames consistently 1 foot in depth.

Unit energy release rate.--We have seen that backfires are slower moving, of longer duration, and have less flame depth than headfires. The next step is to identify differences in burning rate. From data on weight loss it is possible to calculate the steady rate at which combustion releases the energy stored in the fuel. Figure 4 gives the results of calculations for each air velocity. Unit energy release rate drops faster in headfires than in backfires from a peak of 3,200 B.t.u./square foot minute under a no-wind condition.

Unit energy release rate is greatest when low rates of spread combine with brief residence times. As air velocity increases, headfires spread faster, but consume only surface fuels. As shown previously, residence time is briefer when the fire backs into the wind. Backfiring and long residence time reduce unit energy release rate. Had our fuel beds been thicker than 3 inches, the backfires might have maintained a greater energy release rate than they did. This view is supported by data on burn thickness (fig. 5).



Burn thickness. --We calculated the amount of fuel consumed per unit area by combining weight loss and rate of spread data. Since the area of the fuel bed was known, these values were readily converted to a measure of how deeply the fire burned into the fuel bed. The resulting estimates of burn thickness are more precise than physical measurements of the depth of fuel remaining after the fire. Headfires consume less fuel as positive air velocity increases (fig. 5), whereas backfires consume more fuel at a steady rate once negative air velocity exceeds 1.5 m.p.h. In this study, backfires burned at least twice as deep into the fuel bed as headfires did. Backfires consumed all of the fuel available and drove moisture from the asbestos base of the frame. It therefore seems reasonable to assume that the backfires would have burned even more fuel from a deeper bed, and thus would have increased the energy release rate. The no-wind fire left some residual fuel. Headfires left more fuel unburned than they consumed.

### SUMMARY AND CONCLUSIONS

Burning characteristics of backfires in beds of ponderosa pine needles 3 inches deep and 18 inches wide did not change over a range of  $1\frac{1}{2}$  to 8 m.p.h. air velocity. In contrast to headfires, backfires spread more slowly and had less flame depth, longer residence time, and a higher rate of unit energy release. Backfires burned much deeper into fuel beds than headfires did.

The influence of depth and width of fuel beds on characteristics of burning needs further study. The extent to which backfires can burn deep into the needle fuels was not established in this investigation, since fuel in the 3-inch beds was entirely consumed. Experimental needle beds should be deepened until backfires can no longer completely consume the fuel. Other kinds of fuels might exhibit different backfire and headfire relations.

Backfires may facilitate preparation of seedbeds and planting sites by reducing more needle litter on prescribed burning blocks than headfires do. Field tests are necessary to compare the depths of burn and rates of spread of the two types of fire in slash fuels.

#### FOREST SERVICE CREED

The Forest Service of the U. S. Department of Agriculture is dedicated to the principle of multiple use management of the Nation's forest resources for sustained yields of wood, water, forage, wildlife, and recreation. Through forestry research, cooperation with the States and private forest owners, and management of the National Forests and National Grasslands, it strives — as directed by Congress — to provide increasingly greater service to a growing nation.



# Research Note

UNITED STATES DEPARTMENT OF AGRICULTURE  
FOREST SERVICE

## INTERMOUNTAIN FOREST & RANGE EXPERIMENT STATION

OC DEN APR 18 1966 UTAH

STATE UNIVERSITY LIBRARY  
S. I. TECH. & AGR. DIV.

U.S. Forest Service  
Research Note INT-40

1965

### A STRAIN GAGE DIFFERENTIAL WEIGHING SYSTEM

Erwin H. Breuer, Electronic Development Technician

#### ABSTRACT

Explains the nature of strain, discusses several uses of strain gages, and describes the use of strain gages to measure loss or gain in weight of fuel beds in experimental burnings in the laboratory. Describes methods of installing strain gages for fire studies, and shows procedures for instrumentation and calibration.

Research projects at the Northern Forest Fire Laboratory have studied the influence of environmental conditions upon fire characteristics. The environmental conditions affect rate of spread, flame depth and length, rate of burning, and the radiant heat output. Methods and instrumentation were available to measure all of these parameters except rate of burning. Loss of weight in the fuel bed during a fire would indicate the rate of burning and give a measure of the rate of energy release. A weighing system was developed for recording the loss of weight of fuels burned in the wind tunnel and in the combustion laboratory.

The strain gage was selected as the sensing element for detecting weight change. After initial tests with cantilever beams proved unsatisfactory, force rings were used as the force-transferring mechanism. The transducers comprising force rings and strain gages allow continuous monitoring and recording, minimize frictional losses, and tend to compensate for side loading effects caused by poor alignment of the fuel bed on the weighing system.

#### WHAT STRAIN IS

Strain is a fundamental physical phenomenon.<sup>1</sup> It exists in solids at all times, due either to loads or to the weight of the material itself. The terms "strain" and "physical deformation" are synonymous. In engineering, "strain" refers to the change in any linear dimension of a body when a force is applied. Strain, as referred to above, is total strain, but of greater significance is unit strain. Average unit strain is the total deformation of a body in a given direction divided by the original length in that direction.

<sup>1</sup> Nalle, David H. Fundamentals of strain measurement and recording. Automatic Control 15(5): 51. 1961.

Strain equals the change in length divided by the original length. This change is very small and is expressed in microinches or millionths of an inch. Strain gages are electromechanical transducers that are attached to the surface of a structure. The general system is shown in figure 1.

The strain gage exhibits a change of electrical resistance with a change in strain. The change is linear and may be measured with suitable instrumentation. Although indirect, this method is precise. Sensitivity of a strain gage is determined by the electrical conductivity of the sensing element material and its configuration, and this is predetermined by the manufacturer. "Gage Factor" is a measure of strain gage sensitivity. All commercial resistance strain gages have a positive gage factor. This means that an increase in strain produces an increase in strain gage resistance.

In use, each portion of the strain gage is intimately bonded to the member being tested and accurately follows its movement under both tension and compression.

### DESIRABLE CHARACTERISTICS OF STRAIN GAGES

An ideal universal strain gage would have the following characteristics:

1. Capability of measuring strains accurately under static or dynamic conditions.
2. Small size, light weight, and negligible thickness.
3. Suitability for remote observation and recording.
4. Resistance to influence of temperature, vibration, humidity, or other ambient conditions.
5. Ease of installation on member being analyzed.
6. Good stability and negligible hysteresis.
7. Large linear output in response to strain.

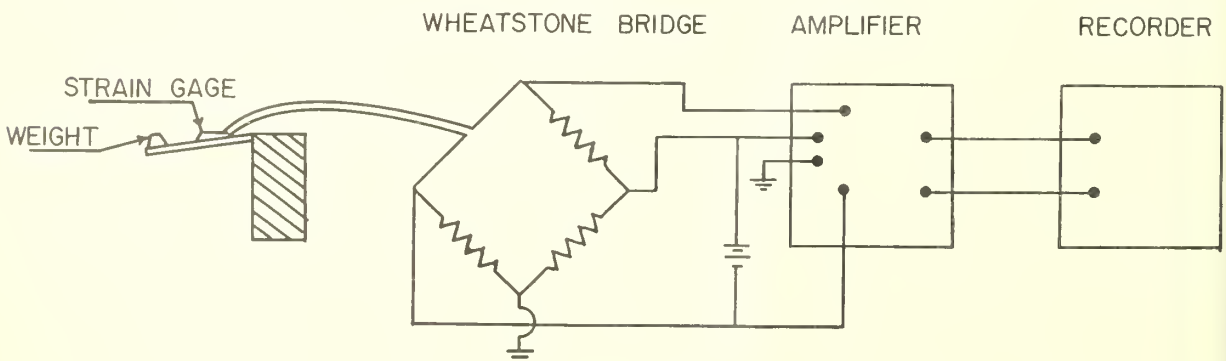

Figure 1.--A single gage configuration.

8. Low unit cost.
9. Dependability and resistance to aging or fatigue.
10. Capability of operating as an individual strain gage.

Etched foil strain gages. --Etched foil strain gages have practically all of these desirable characteristics. Several hundred different types and sizes are available commercially.

Temperature compensation. --Temperature compensation is one of the most important and one of the most frequently overlooked factors in strain measurement. It is possible to start out to measure strain and end up measuring ambient temperature changes because of the strain gage's sensitivity to temperature and to change in length.

Where transient temperature conditions are encountered, the best accuracy will be obtained by using temperature-compensated strain gages.

Many people mistakenly connect a single strain gage to a Wheatstone bridge with only two lead wires. Variation in ambient temperature introduces a variable resistance in one leg of the bridge that causes the measuring instrument to indicate a strain that does not exist. Using the Siemens three-lead method compensates for temperature variation in the leads.

In this three-lead method, two leads are in adjacent legs of the bridge. This cancels their resistance changes and does not disturb the bridge balance. The third lead is in series with the power supply and is, therefore, independent of bridge balance.

#### APPLICATION IN FIRE RESEARCH

Constantan foil, paper-base strain gages were used for some studies at the Northern Forest Fire Laboratory. The strain gages were mounted according to instructions enclosed with each packet of gages. These instructions must be followed closely to achieve good results. The gages were cemented to force rings made of 61S(6061) aluminum 1-5/8 inches in diameter and with 1/16-inch wall thickness; one gage was cemented to the inside (compression) and one

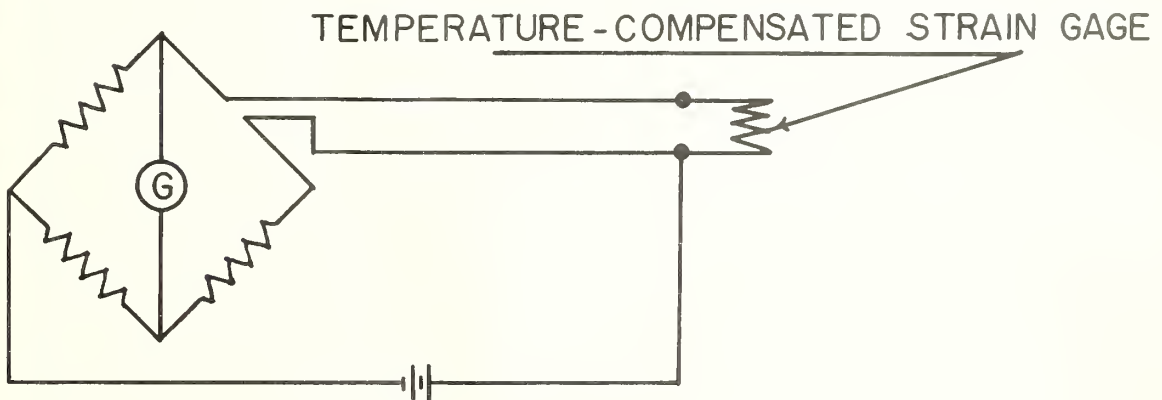

Figure 2. --Temperature-compensated three-lead wire system.

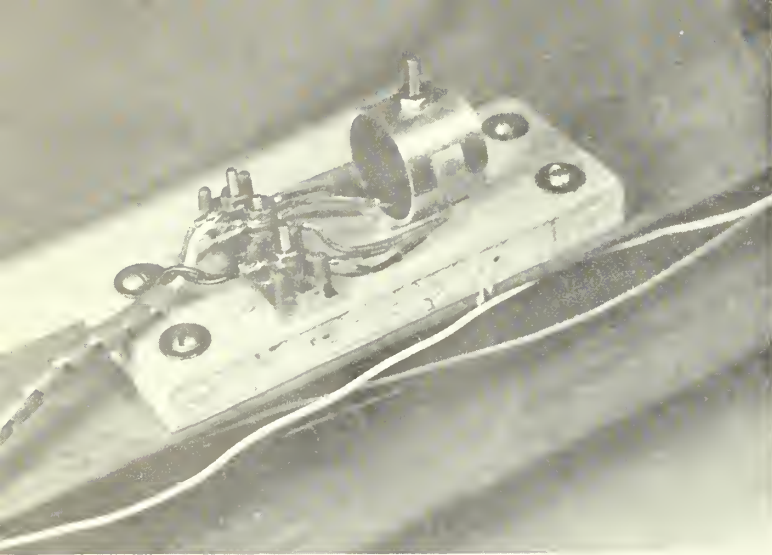

Figure 3. --Single force ring with two strain gages mounted on fuel bed support.

to the outside (tension) directly opposite each other (figs. 3 and 4). Four of these force rings were placed, one at each corner, under a fuel bed 8 feet long by 2 feet wide (figs. 5, 6, and 7). Although each force ring equipped with strain gages is temperature-compensated, when the four force rings are connected into the Wheatstone bridge, the total circuit does not have complete temperature compensation. This is probably due to slight differences between gages and temperatures at the four gage locations. To correct for temperature differences between locations, the force rings were enclosed in a masonite box painted with aluminum. A teflon cap was placed over the bolt stud and a plywood strip bolted to the metal crossarms to minimize heat conduction. To minimize changes induced by fluctuations in humidity, the strain gages were coated with a waterproofing wax.

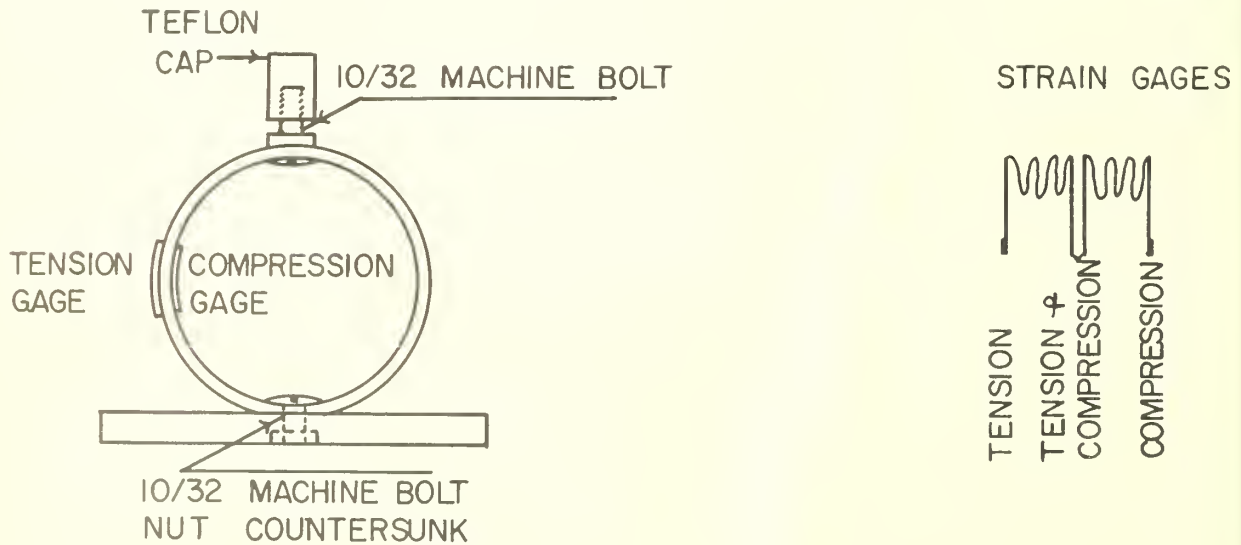

Figure 4. --Force ring configuration and strain gage electrical connection.

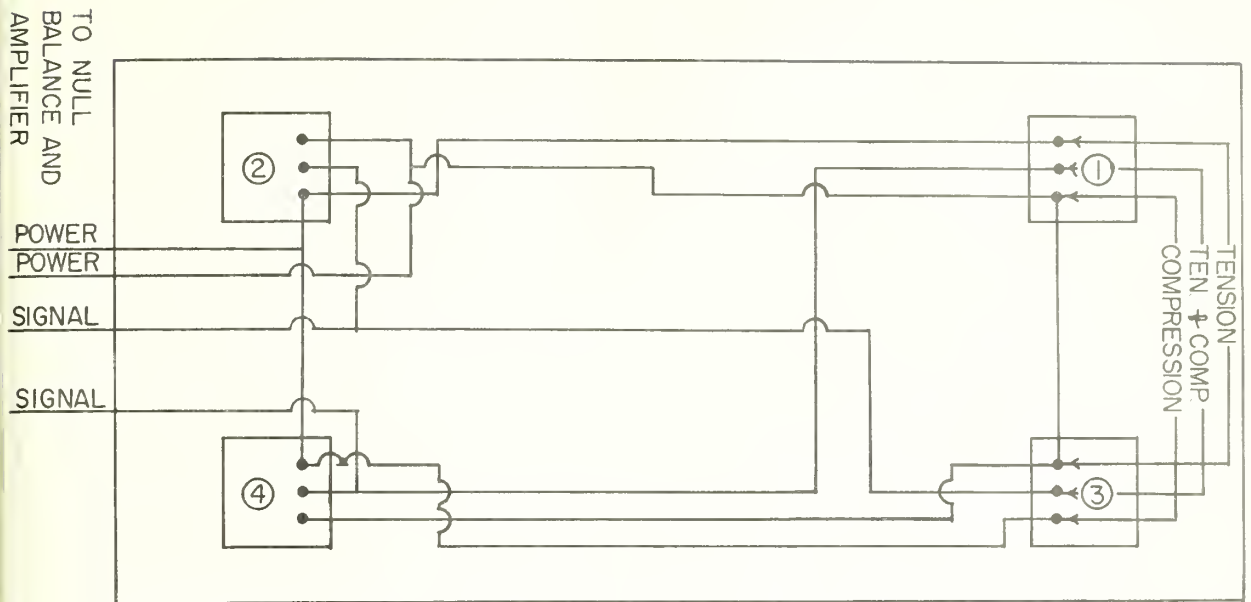
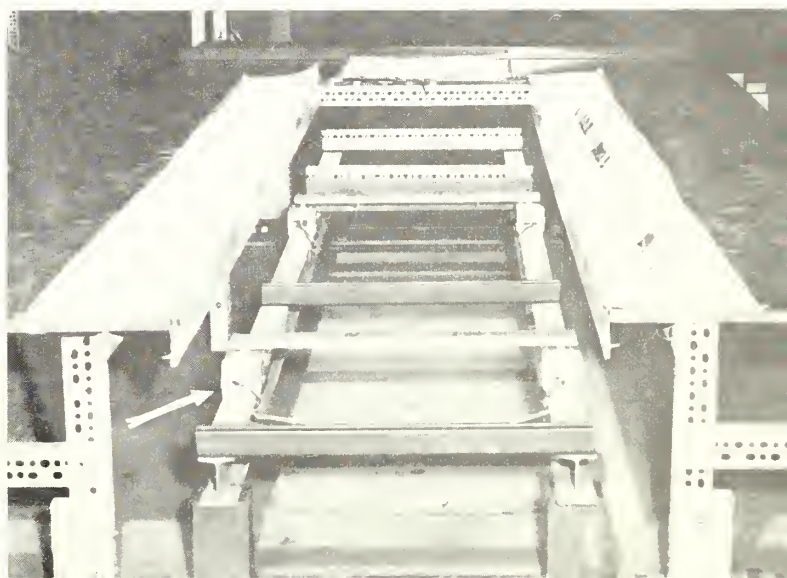

Figure 5. --Electrical schematic for straingages under the fuel bed tray 8 feet long by 2 feet wide.

Each force ring was calibrated individually for sensitivity and checked for linearity and hysteresis. Linearity and hysteresis were very good and the sensitivity was as follows: (1)  $5.13 \mu\text{v}/\text{oz.}$ , (2)  $4.75 \mu\text{v}/\text{oz.}$ , (3)  $6.26 \mu\text{v}/\text{oz.}$ , and (4)  $6.00 \mu\text{v}/\text{oz.}$ , all with 6 volts excitation. The force rings were placed so that one of high sensitivity was diagonally opposite to one of low sensitivity. Linearity and hysteresis were checked by placing crossarms across a pair of force rings at each end of the fuel bed; these were interconnected with a crossbeam. Weights in 2-ounce increments up to 3 pounds were then placed on this crossbeam and the results were recorded (fig. 8). The crossbeam was removed, and a loaded fuel bed was then placed on the crossarms; weights in 4-ounce increments up to 3 pounds were then placed on the fuel bed and a calibration was made for 90 divisions on the recorder.

Figure 6. --Four force rings mounted on fuel bed support under aluminum painted boxes.



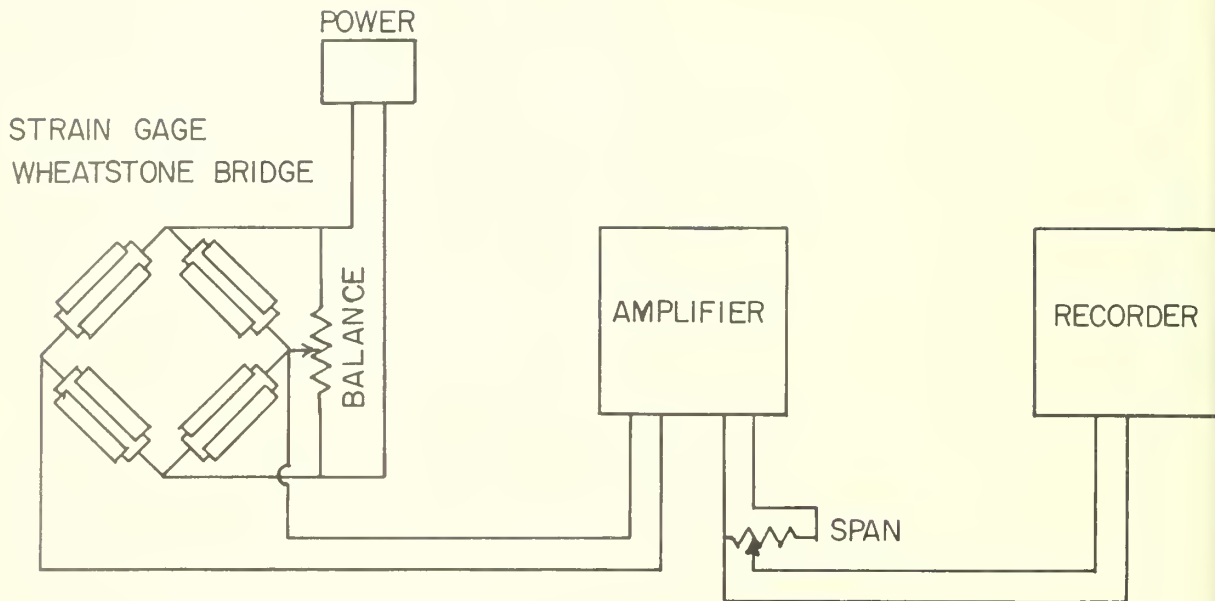

Figure 7. --Instrumentation layout for weight loss measuring system.

In operation, the weighing system provides a visual interpretation of the history of a burning operation. After ignition, a gradual buildup to a uniform burning rate may be observed. A flareup or suppression of flaming may be identified by the change in slope of the trace on the recorder. When the flame front has died out, the trace levels out and shows the gradual loss of weight due to afterburning. The average rate of weight loss is indicated by the slope of the line during the time in which the rate was stable.

This weighing system has had several useful applications. During tests of chemical fire retardants, it was used to monitor the loss of weight of moisture and to determine the proper drying conditions before experimental test burning of the fuel. The moisture content and response of a particular fuel type can be determined by using this strain gage weighing system. When a specific amount of fuel was oven-dried and brought out to room temperature and room humidity, the weight change was recorded by this device. Also, fuel was placed in a covered container with a saturated sponge for a measured length of time before it was removed and the weight change recorded.

The burning characteristics of fuels can be evaluated when loading, compactness, and air supply rates are changed. A small fuel bed was weighed with a single transducer and changes in burning rate were recorded. Changes in burning rate could be equated to changes in any of several parameters (e.g., rate of spread, depth and length of flame, output of radiant heat, etc.).



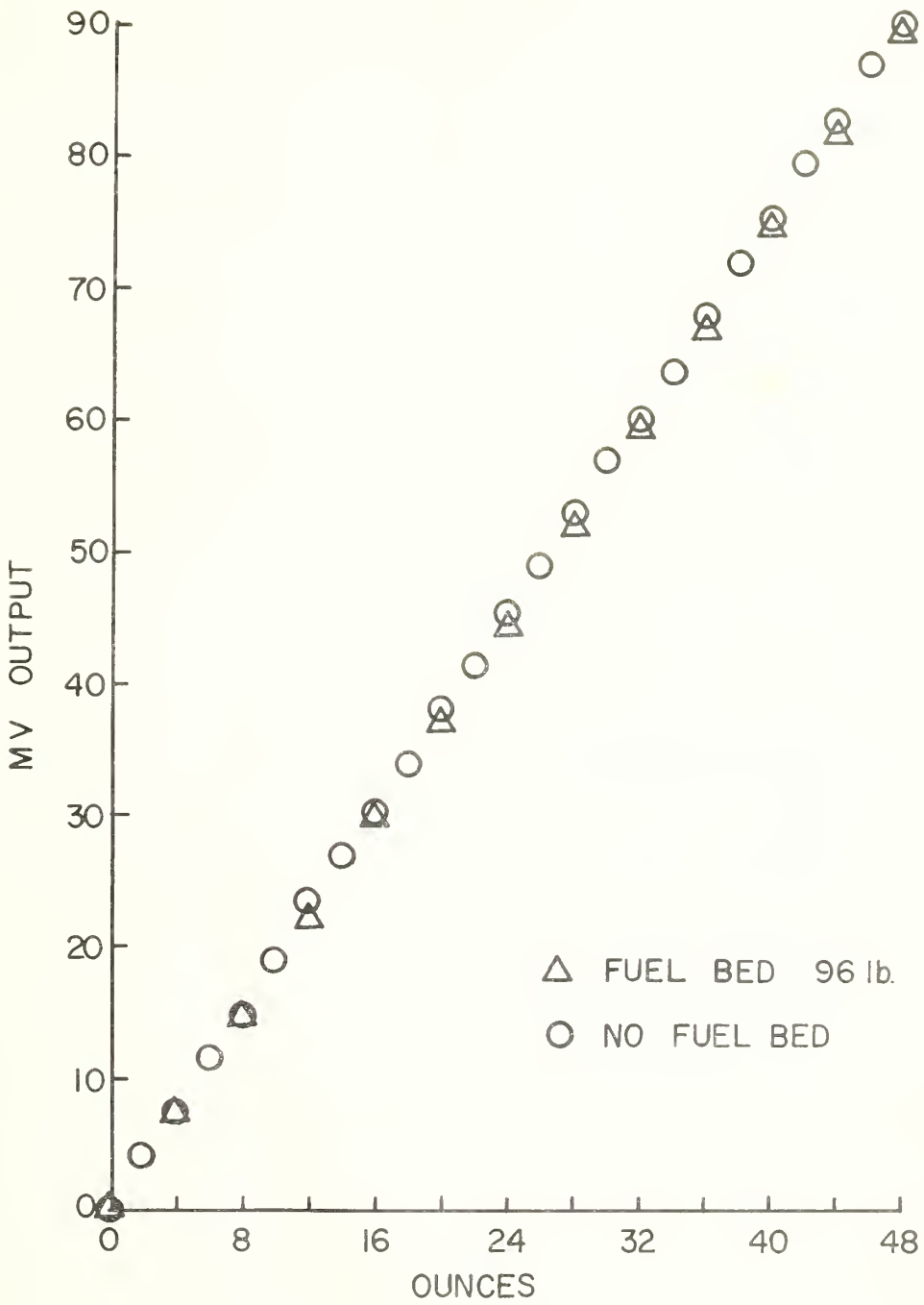

Figure 8. --Calibration comparison of a 96-pound load and no load.

## CONCLUSIONS

It is possible to build a weighing system with strain gage transducers which is accurate and dependable, and provides a high sensitivity despite tare weights of 16 times the active load. The transducers are small and compact, and contain no moving parts. The output of the system is an electrical signal that can be recorded; this allows the rate of change of weight to be obtained. Strain gage measurements have proved to be reliable and valuable in studies of fire physics and fire behavior by determining change of weight in varied sizes of fuel samples.

These devices can also measure pressure, torque, force, stresses and strains with structures, and windspeed. Measurement of windspeed and direction can be made automatically with more complex arrangements of strain gages.

### **FOREST SERVICE CREED**

The Forest Service of the U.S. Department of Agriculture is dedicated to the principle of multiple use management of the Nation's Forest Resources for sustained yields of wood, water, forage, wildlife, and recreation. Through forestry research, cooperation with the States and private owners, and management of the National Forests and National Grasslands, it strives — as directed by Congress — to provide increasingly greater service to a growing Nation.



# Research Note

UNITED STATES DEPARTMENT OF AGRICULTURE  
FOREST SERVICE

INTERMOUNTAIN FOREST RANGE EXPERIMENT STATION  
OGDEN UTAH

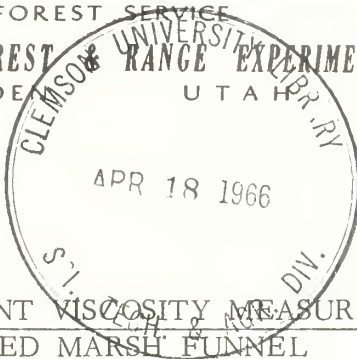

U.S. Forest Service  
Research Note INT-41

1966

## FIRE RETARDANT VISCOSITY MEASURED BY MODIFIED MARSH FUNNEL

Charles W. George and Charles E. Hardy\*

### ABSTRACT

This paper describes modifications necessary to make a Marsh Funnel suitable for measuring viscosities of chemical fire retardants in the field.

Use of chemical retardants in forest fire suppression is now a firmly established procedure. Proper viscosity for each retardant material and each type of use is necessary for most effective application. The viscosity of fire retardants is extremely difficult to estimate visually; most viscometers capable of rendering reliable measurements are expensive, and cannot be used in rough field situations.

The desirable viscosity of a fire retardant depends on the job for which it will be used. Retardants applied from ground equipment must be viscous enough to build up a thick layer on the fuel, but must remain easy to pump. Those applied from air tankers must be more viscous in order to cling together during the drop and to reach and adhere to the fuel properly.

To provide the measurements of viscosity needed in the field, a Marsh Funnel<sup>1</sup> can be modified for use with all commonly used fire retardants. This funnel has a

\*Research foresters, stationed at Intermountain Forest and Range Experiment Station, Northern Forest Fire Laboratory, Missoula, Montana.

<sup>1</sup>The Marsh Funnel is usually used to measure viscosity of oil well "drilling muds" and is manufactured by the Baroid Division, National Lead Co., P.O. Box 1675, Houston, Texas. Mention of trade or brand names is solely for identification and does not imply endorsement of products mentioned, nor does it imply nonendorsement of unnamed products.

diameter of 6 inches at the top, and a total length of 12 inches. The 10-mesh screen that covers half of the top should not be used as it may change the structure of the retardant.

Viscosity is measured by agitating the fluid, pouring it into the funnel up to the screen, and recording the time in minutes and seconds necessary for 1 quart to pass through. Several fire-retardant materials have a much higher viscosity than do the drilling muds for which the funnel was designed; thus the orifice, or tip, is not large enough to accommodate these retardants. However, if the original tip is removed and replaced by a larger one, satisfactory determinations of viscosity can be made in the field. The large tip is used alone for the thicker materials, or the original one can be reinserted for measuring the thinner, less viscous materials.

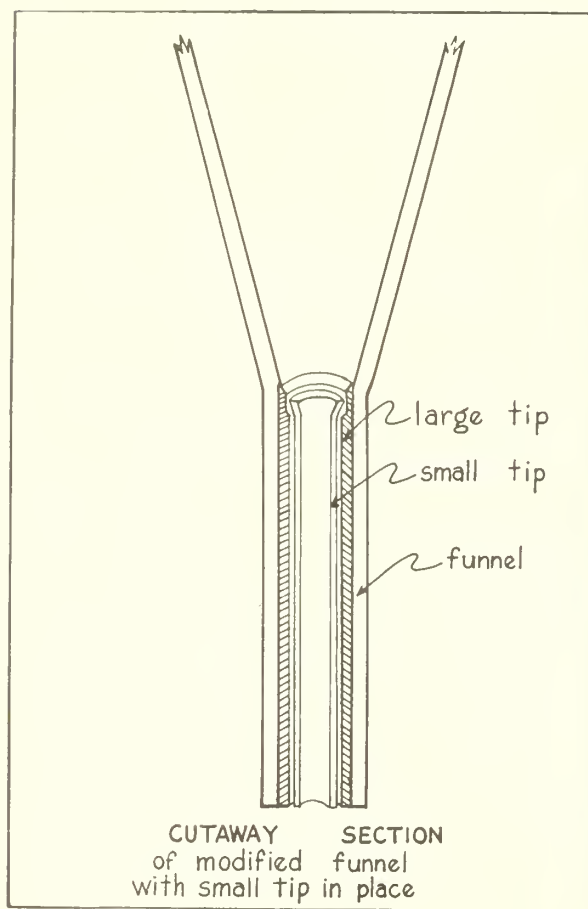

Figure 1.--Cutaway section of the modified Marsh Funnel with small tip in place.



Figure 2.--Measuring viscosity with modified Marsh Funnel.

## METHOD OF DETERMINING VISCOSITY

There is no single correlation between calibration of the Marsh Funnel and that of rotational viscometers (e.g., Brookfield) for all retardants; the two types of instruments respond differently to such characteristics as rate of gelation, gel strength, thixotropy, and density. Consequently, the Marsh Funnel must be calibrated for each fire-retardant material. The following method established the relation between viscosity measured in centipoises and in "Marsh Funnel seconds":

1. We mixed samples of each retardant at several viscosity levels. The retardant material stood untouched for 15 to 18 hours after mixing.
2. A Brookfield model LVF viscometer, at 60 r.p.m. and using spindle 4 (spindle 2 for Phos-Chek 259), rendered viscosity measurements in centipoise units. The readings were taken after the spindle had turned for 1 minute in the sample.<sup>2</sup>
3. From the same sample we filled the Marsh Funnel to the screen and measured the time in seconds required for 1 quart to run out the bottom into a graduated beaker. Measurements were made using both the large- and small-sized tips.
4. Three replications of both Brookfield viscometer and Marsh Funnel measurements showed close reproducibility; the data were not statistically treated. Data for the various samples were plotted, and the best curve was fitted to these points by the method of least squares.<sup>3</sup>

Table 1 shows the relation between viscosities measured by the Brookfield viscometer and the "Marsh Funnel seconds" equivalents.

---

<sup>2</sup> Gelgard thinned rapidly when subjected to the revolving spindle; this made necessary a 15-second turning time before reading.

<sup>3</sup> The linear relation between actual viscosity and Marsh Funnel time for Phos-Chek 259 permitted the equation for the best possible curve to be solved by a computer method of least squares for fitting polynomial curves. This method of curve fitting could not be used for most fire retardants because the curves did not approximate polynomials, but tended to be exponential functions.

Table 1. --Relation of Marsh Funnel time to viscosity as measured by the Brookfield Viscometer Model LVF, at 60 r.p.m.

Time for 1 quart to flow through funnel <sup>1</sup>		Fire-retardant material									
		Gelgard M		Gelgard F		Phos-Chek		Bentonite	Fire-Trol 100		
		Large tip	Small tip	Large tip	Small tip	202 tip	259 tip		Large tip	Large tip	Small tip
Min.	Sec.	Centipoise									
0	15							500			930
0	30		20		20		5	1875			2140
1	00	550	170	625	153	1000	136	2450			2800 1460
1	30	700	280	780	275	1380	274	2675			2940 1810
2	00	820	370	883	378	1640	413	2815			1960
2	30	908	442	962	471	1855		2925			
3	00	980	508	1038	550	2010		3005			
4	00	1098	616	1180	672	2315					
5	00	1188		1316		2560					
6	00	1264		1444		2760					
7	00	1327				2950					
8	00	1387									

<sup>1</sup>Funnel must be FULL to screen before testing begins.

### INSTRUCTIONS FOR MODIFICATION AND USE

A packet to help field personnel modify and use a Marsh Funnel in measuring viscosity is available for free distribution by requesting a MARSH FUNNEL PACKET from

Northern Forest Fire Laboratory  
U.S. Forest Service  
Missoula, Montana 59801

The packet contains

1. Instructions for modification
2. A drawing of the modification
3. Instructions for using table 1
4. Table 1: For each 5 seconds through 3 minutes  
For each 10 seconds beyond 3 minutes



# Research Note

UNITED STATES DEPARTMENT OF AGRICULTURE  
FOREST SERVICE

INTERMOUNTAIN FOREST & RANGE EXPERIMENT STATION  
OGDEN UTAH

U.S. Forest Service  
Research Note INT-42

1966

SITE INDEX CURVES FOR ENGELMANN SPRUCE IN THE NORTHERN  
AND CENTRAL ROCKY MOUNTAINS

James E. Brickell<sup>1</sup>

ABSTRACT

This paper presents in graphic and tabular form a set of polymorphic site index curves for Engelmann spruce. The curves are based on a new generalization of the Osborne-Schumacher method of site curve construction. A table of standard errors of the estimate obtained by given numbers of sample trees per plot will help the user establish desired sample size. Approximation equations are also given so these polymorphic site curves can be used in computer programs. The basic data came from the northern and central Rocky Mountain area, but a statistical test with limited data from Arizona and New Mexico indicates the site index curves may also be valid for the southwestern States.

INTRODUCTION

This paper presents a new system of polymorphic site index curves for Engelmann spruce (*Picea engelmanni* Parry) in the Mountain States. Polymorphism in a set of curves means that the shape of the curves varies from one level of site index to another; that is, the curves are not proportional, in contrast to anamorphic or proportional curves. Differences between polymorphic and anamorphic site index curves, and the superiority of the former, are discussed in the standard forest mensuration texts (Husch 1963; Spurr 1952). Two equations with which electronic computers can be used to replace manual methods of site index assignment are also given.

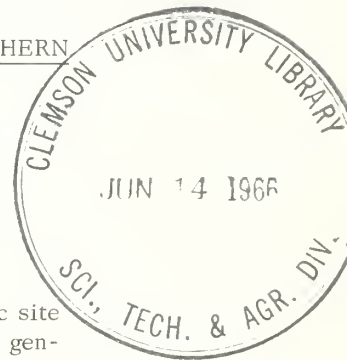

<sup>1</sup> Associate mensurationist, stationed at Intermountain Forest and Range Experiment Station, Forestry Sciences Laboratory, Moscow, Idaho.

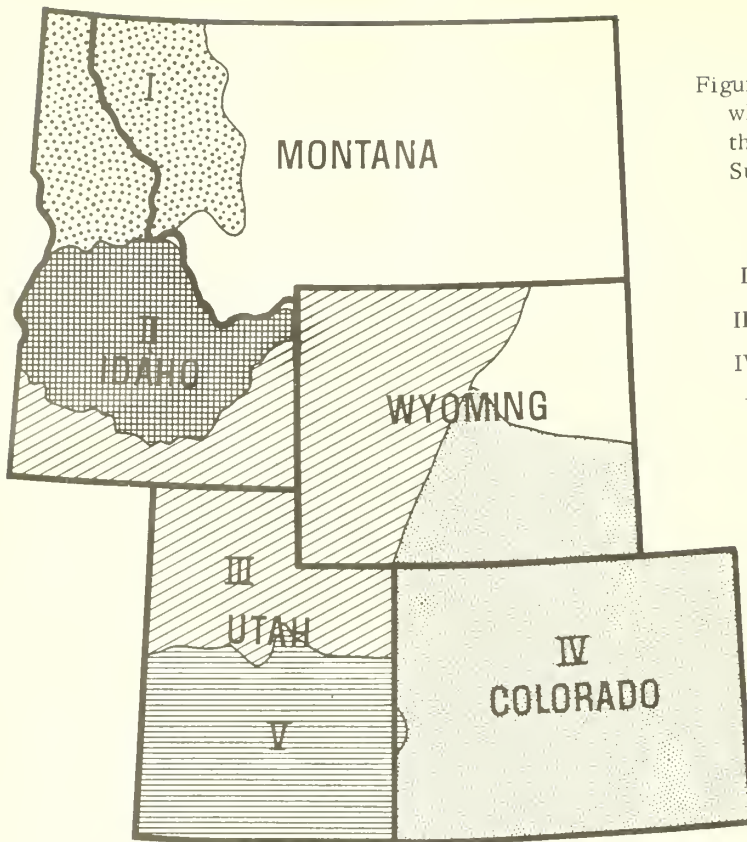

Figure 1.--The area from which the data used in this study were drawn. Subregions are:

- I
- II
- III
- IV
- V

#### SOURCE OF DATA

The data upon which the construction of these curves was based are measurements of total age and total height for 1,928 dominant and codominant spruce trees. These data were collected by Forest Survey in the course of forest inventories over the past 10 years. The geographical area sampled is shown in figure 1. This area was divided into five subregions, differing from one to another with respect to general climatic conditions that might influence tree growth (U.S. Department of Agriculture 1941). From one to three trees were measured on each Forest Survey sampling location<sup>2</sup> which fell within the Engelmann spruce type. Total tree age was obtained by counting annual rings on an increment core taken at breast height and adding to this the estimated time required for the tree to reach breast height. Data of this kind are, of course, inferior to repeated height measurements on permanent plots or to stem analysis data. Nevertheless, because a need has long existed for a means of classifying Engelmann spruce stands according to site quality, the data available were used in such a way as to extract as much information as possible.

#### SITE INDEX CURVES AND TABLE

The site index curves resulting from this study are shown in figure 2. The index base age is 50 years.<sup>3</sup> Table 1 shows the expected height of trees in the dominant stand according to total age and site index.

<sup>2</sup> As used by Forest Survey, "location" refers to a cluster of either two or three fixed area or 10 variable radius plots. Fixed area plots were either one-fourth or one-fifth acre in size.

<sup>3</sup> The base age is established arbitrarily and in no way affects the shape of the resulting curves.



## HOW TO USE THIS INFORMATION

To estimate the average site index for a stand of Engelmann spruce, measure total age and total height of trees that are in the dominant portion of the stand. Site trees should also give evidence of having been in the dominant stand throughout their lives. Table 2 shows the sample size expected to be necessary on plots up to 1 acre in size in order to attain a given standard error of the estimated mean plot site index. These estimates of required sample size are based on the variance of site index between individual trees within forest survey plot clusters on homogeneous sites. As plot size decreases below one-fourth acre, a somewhat smaller sample may achieve the same precision. Using figure 2 or table 1, estimate a site index value for each sample tree. The average site index for all sample trees will be the best estimate of average site index for the area sampled.

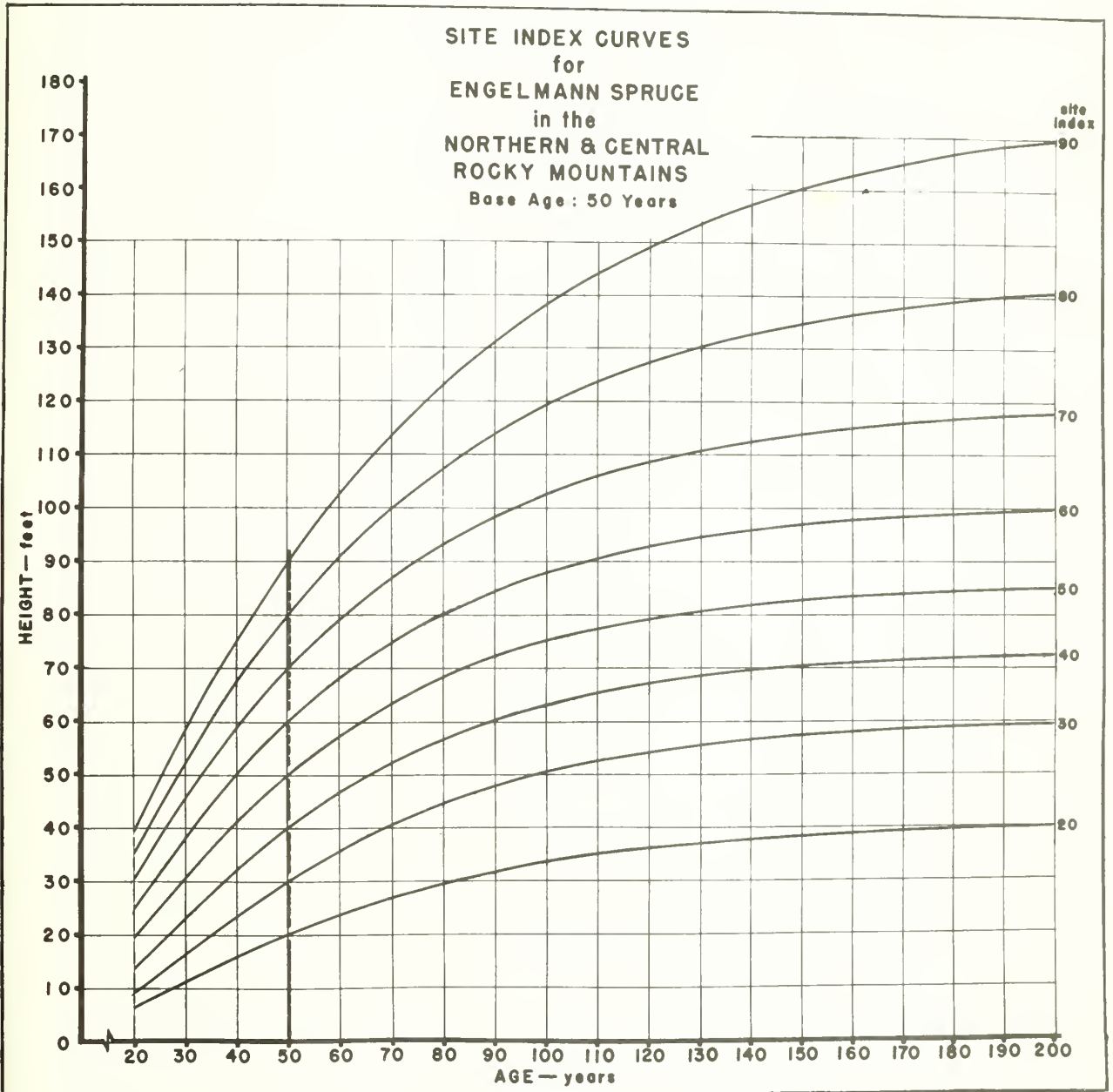

Figure 2.--Height on age curves at several levels of site index.

Table 1. --Height (in feet) of trees in the dominant stand by age and site index<sup>1</sup>

Total age (years)	Site index								
	20	30	40	50	60	70	80	90	
20	6	9	14	19	25	30	35	40	
30	11	16	23	31	38	46	52	58	
40	16	23	32	41	50	59	67	75	
50	20	30	40	50	60	70	80	90	
60	24	36	47	57	68	79	91	103	
70	27	41	52	63	75	87	100	114	
80	30	45	57	68	80	93	108	123	
90	32	48	60	72	85	99	114	132	
100	34	51	63	75	88	103	119	138	
110	35	53	65	77	91	106	124	144	
120	36	54	67	79	93	109	128	149	
130	37	56	69	81	95	111	131	154	
140	38	57	70	82	96	113	133	157	
150	39	57	70	83	97	114	135	161	
160	39	58	71	84	98	115	137	163	
170	39	59	72	84	99	116	138	165	
180	40	59	72	85	99	117	139	167	
190	40	59	72	85	100	118	140	169	
200	40	60	73	85	100	118	141	170	

<sup>1</sup> All height values are rounded to the nearest foot.

Table 2. --Standard error of mean plot site index to be expected from samples of given size

Sample size (no. of trees)	Standard error expected (feet)	
	Idaho and Montana	Wyoming, Utah, Colorado, Arizona, and New Mexico
1	10.21	6.94
2	7.22	4.90
3	5.89	4.00
4	5.10	3.47
5	4.57	3.10
6	4.17	2.83
7	3.86	2.62
8	3.61	2.45
9	3.40	2.31
10	3.23	2.19
15	2.64	1.79
20	2.28	1.55
25	2.04	1.39

APPROXIMATIONS FOR ELECTRONIC COMPUTER PROGRAMS

The equation expressing tree height as a function of age and site index (as shown on page 7) cannot be solved explicitly for site index given age and height. Yet an equation expressing estimated site index as a function of age and height is desirable for incorporation in computer programs. Therefore, the following equation was derived to approximate the site index curves in an explicit form:

$$S = H + b_1 X_1 + b_2 X_2 + b_3 X_3 + b_4 X_4 + b_5 X_5 + b_6 X_6 + b_7 X_7 + b_8 X_8 + b_9 X_9 + b_{10} X_{10} + b_{11} X_{11} \quad (1)$$

where:

$b_1 = 0.10717283 \times 10^2$	$X_1 = (\ln A - \ln 50)$
$b_2 = 0.46314777 \times 10^{-2}$	$X_2 = [(10^{10}/A^5) - 32]$
$b_3 = 0.74471147$	$X_3 = H[(10^4/A^2) - 4]$
$b_4 = -0.26413763 \times 10^5$	$X_4 = H(A^{-2.5} - 50^{-2.5})$
$b_5 = -0.42819823 \times 10^{-1}$	$X_5 = H(\ln A - \ln 50)^2$
$b_6 = -0.47812062 \times 10^{-2}$	$X_6 = H^2[(10^4/A^2) - 4]$
$b_7 = 0.49254336 \times 10^{-5}$	$X_7 = H^2[(10^{10}/A^5) - 32]$
$b_8 = 0.21975906 \times 10^{-6}$	$X_8 = H^3[(10^{10}/A^5) - 32]$
$b_9 = 5.1675949$	$X_9 = H^3(A^{-2.75} - 50^{-2.75})$
$b_{10} = -0.14349139 \times 10^{-7}$	$X_{10} = H^4[(100/A) - 2]$
$b_{11} = -9.481014$	$X_{11} = H(A^{-4.5} - 50^{-4.5})$

S = site index  
H = total tree height  
A = total tree age  
ln is the natural logarithm, i.e., to base e.

When age is 50 years all terms in the equation come to zero, except the first, and at that age site index equals height. The standard error of estimate (Syx) for this equation is 0.689125 foot of site index units.

If a shorter, but less precise equation is desired, the following is recommended:

$$S = H + k_3 X_3 + k_4 X_4 + k_6 X_6 + k_9 X_9 + k_{10} X_{10} \quad (2)$$

where:

$k_3 = 0.32158242$
$k_4 = -0.98468901$
$k_6 = -0.12253415$
$k_9 = 1.0662061$
$k_{10} = -0.80894818$

and other symbols are as previously defined. For the abbreviated equation, Syx = 1.22469 feet.

These equations are valid for trees between the ages of 20 and 200 years and for site indices ranging from 10 to 95. Only 1 percent of trees have been found to reflect a site index higher than 75, so very few trees will be outside the range of the equations. If trees older than 200 years must be used as site trees, estimate the site index as if tree age were 200. Above that age, height growth has decreased to very little. Either of the two equations given can be used to estimate site index instead of using figure 2 or table 1.

It is intended that the technique by which these curves were constructed will be described more thoroughly in a future publication. The information in this section indicates only the basis of these site index curves.

Polymorphism within the family of curves was achieved by a generalization of the method described by Osborne and Schumacher (1935). The generalization considers not only the trend of standard deviation, but also the skewness and kurtosis of residuals about the mean curve of height over age. This was done by dividing the site tree observations into 19 groups according to ascending values of total tree age. Each group contained about 100 paired measurements of age and height. Nine percentage points of the distribution of heights within each age group were estimated. These points represent the heights such that 1, 5, 10, 25, 50, 75, 90, 95, and 99 percent of the trees in each group were shorter than the respective limit. The estimates were based on tables of probability percentage points for skewed frequency distributions (Johnson, Nixon, and Amos 1963). When connected, the points established for a given level of probability, e.g., the 75-percent point, in the 19 groups of measurements form a curve of height over age. This can be assigned a site index by reading its height at the index age of 50 years. It can then be said that this, or greater, site index will be expected in one-fourth of all Engelmann spruce stands in the area from which the basic data were taken.

Nine curves of height over age, one for each probability level, were drawn by connecting the points for the respective probability level in each of the 19 age classes.

Several growth equations were fitted to these curves in an attempt to express the relationship between tree height and tree age. The most appropriate was found to be:

$$H^{1-m} = a^{1-m} [1 - b \cdot \exp(-kA)] \quad (3)$$

where:

H = total tree height

A = total tree age

a, b, k, m are coefficients of the equation to be estimated by the method of least squares.

$\exp(-kA)$  means e, the base of Napierian logarithms, taken to the  $(-kA)$  power.

This model and its use as a growth curve have been discussed in detail by Richards (1959).

Coefficients were estimated for the nine curves. Each of the nine equations which resulted was solved for height at age 50, thereby assigning a site index value to each set of 19 equiprobable points.

The height of trees in the dominant stand is not a function of tree age alone, but also of the site upon which the trees are growing. Site index was introduced into the tree height equation as an independent variable by expressing the coefficients of equation (3) as functions of site index in the following manner:

$$a = p_0 + p_1 S + p_2 S^2 + p_3 S^3 \quad (4)$$

$$k = \exp(q_0 + q_1 S + q_2 S^2) \quad (5)$$

$$m = \exp(r_0 + r_1 \ln S + r_2 \ln^2 S) \quad (6)$$

where:

s = site index

a, k, m are coefficients of equation (3), and  $p_i$ ,  $q_i$ ,  $r_i$  are coefficients to be estimated in the multivariate equation.

Because the height of all trees must be zero at age zero, this constraint was placed on the curves by holding the coefficient  $\underline{b}$  in equation (3) constant at the value of 1.0 or, in other words, eliminating it from

the equation. The introduction of site index into the multivariate height equation as shown in equations (4), (5), and (6) allows the resulting site curves to be polymorphic.

The multivariate function was then fitted to the nine sets of equiprobable points, with site index for each set entered as an independent variable. The final equation used to express tree height as a function of age and site index is:

$$H^{1-m} = a^{1-m} [ 1 - \exp(-kA) ]$$

with the coefficients,

$$a = 26.38029 + 4.545548S - 0.070759S^2 + 0.000501S^3 \quad (7)$$

$$k = \exp(-3.997462 + 0.01532S - 0.000183S^2) \quad (8)$$

$$m = \exp(-9.603352 + 5.405062 \ln S - 0.817504 \ln^2 S) \quad (9)$$

The curves of figure 2 are described by this equation. Table 1, showing tree height according to age and site index, was obtained by repeated solution of the equation.

#### TESTS OF THE FINAL SITE INDEX CURVES

An essential test of any system of site index curves involves the independence of stand age and estimated site index. If the two are not independent, i.e., if correlation exists, then estimated site index can be expected to change as stand age increases. This has been an undesirable feature of some anamorphic site index curves constructed according to the so-called strip method (Chapman and Meyer 1949; Watt 1960).

Anamorphic site index curves may, by their proportional nature, bring about a correlation between stand age and estimated site index. On the other hand they may not if the true curves of height over age, which we seek to approximate by various mensurational techniques, are really proportional from one level of site quality to another. Such a situation seldom occurs, however. It is advisable to use a mathematical model that can express polymorphic curves, yet can express proportional curves if doing so is necessary to obtain the least-squares fit to the data.

Correlation between age and estimated site index may also be caused by patterns of land use in the past. Curtis (1964) found this to occur with some tree species in New England. In this study it has been assumed that previous land use patterns have not operated to produce such an effect for the following reasons:

1. The data were drawn from a wide geographic area embracing several different economic regions.
2. Most of the data came from National Forests where cutting practices have been rather different from those on smaller private holdings.
3. The effects of cutting practices and land use, if any, have been felt for at least 2 centuries' less time in the Mountain States than in New England.
4. The Engelmann spruce forest type is, in general, located at higher elevations which are some distance removed from agricultural areas.

Beyond the logic of assuming the independence of estimated site index from age, it is possible to test this assumption by the statistical test which will be described.

To test the curves presented in this paper, a site index value was assigned to each of the 1,928 site trees in the basic data. This was also done for a sample of site trees from Arizona and New Mexico, which was obtained too late to be included in the data used in construction of the curves. The site trees were then sorted into six groups, based on the geographical area from which they were drawn. The number of trees in each of the subregional groups was:

Subregion I	Northern Idaho and western Montana . . . . .	194
Subregion II	Central Idaho . . . . .	138
Subregion III	Southern Idaho, northern Utah, and western Wyoming . . . . .	437
Subregion IV	Colorado and eastern Wyoming . . . . .	807
Subregion V	Southern Utah . . . . .	352
Subregion VI	Arizona and New Mexico . . . . .	133

Within each areal group and within all groups combined, an attempt was made to find significant trends of site index with tree age by fitting the equation:

$$S = b_0 + b_1 A + b_2 A^2 + b_3 A^3 \tag{10}$$

to the joint distribution of tree age (A) and estimated site index (S). All multiple correlation coefficients thus obtained failed to indicate significant difference from zero at the 95-percent probability level. Therefore, the hypothesis that there is correlation between stand age and estimated site index was rejected and the two were assumed independent. It should be borne in mind that one cannot claim absolute certainty for any statistical test; at best, only a high probability of being correct can be claimed. In this case, the probability of this assumption's being correct seems quite high.

For the data from Arizona and New Mexico, as for those from other areas, no statistically significant trend of estimated site index with age was observed. This indicates that on the basis of the available data these curves are acceptable for use in Arizona and New Mexico as well as in the other Mountain States. However, because no data used in constructing this system of curves came from Arizona and New Mexico, their title expresses validity only for the northern and central Rocky Mountains.

#### REFERENCES

Chapman, Herman H., and Walter H. Meyer.  
 1949. Forest mensuration. 522 pp. New York: McGraw Hill Book Co.

Curtis, Robert O.  
 1964. A stem-analysis approach to site-index curves. *Forest Sci.* 10(2): 241-256.

Husch, Bertram.  
 1963. Forest mensuration and statistics. 474 pp. New York: The Ronald Press Co.

Johnson, N. L., E. Nixon, and D. E. Amos.  
 1963. Table of percentage points of Pearson curves, for given  $\sqrt{\beta_1}$  and  $\beta_2$ , expressed in standard measure. *Biometrika* 50(3/4): 459-498.

Osborne, J. G., and F. X. Schumacher.  
 1935. The construction of normal-yield and stand tables for even-aged timber stands. *J. Agr. Res.* 51: 547-563.

Richards, F. J.  
 1959. A flexible growth function for empirical use. *J. Exp. Bot.* 10(29): 290-300.

Spurr, Stephen H.  
 1952. Forest inventory. 476 pp. New York: The Ronald Press Co.

U.S. Dep. Agriculture.  
 1941. Yearbook of agriculture: Climate and man. 1,248 pp. Wash., D.C.: U.S. Govt. Printing Office.

Watt, R. F.  
 1960. Second-growth western white pine stands. U.S. Dep. Agr. Tech. Bull. 1226.



# Research Note

UNITED STATES DEPARTMENT OF AGRICULTURE  
FOREST SERVICE

INTERMOUNTAIN FOREST & RANGE EXPERIMENT STATION  
OGDEN

U. S. Forest Service  
Research Note INT-43

1966

## SNOW LOADS ON ROOFS IN AREAS OF HEAVY SNOWFALL

Robert D. Doty and Glenn H. Deutschman<sup>1</sup>

### ABSTRACT

This study tested the feasibility of estimating snow loads on roofs from measurements of depth and water content of snow on nearby ground. The water content, and therefore the weight, of snow on the ground proved comparable to that of snow on roofs.

### INTRODUCTION

The snow load that a building may have to support in regions where snowfall is heavy becomes an important consideration affecting structural design and requirements for winter maintenance. Sharply pitched roofs and metal roofs that promote snow slippage are commonly used to reduce risks of overload. But for reasons of economy, efficiency, or aesthetics, many buildings have no special provisions for snow removal. For such buildings, it becomes especially important to know how heavy a load of snow the building can carry and how this weight corresponds to local characteristics of snow accumulation. If the maximum probable snow load should exceed designed strength of the building, arrangements must be made to strengthen the structure or to shovel the roof clear before critical conditions develop. Arranging for timely shoveling is difficult, particularly for such unoccupied buildings as summer cabins and forest camp facilities in remote mountain

country where roads remain closed during winter.

Two published reports on snow load investigations<sup>2</sup> estimated snow load from standard weather station observations of snow depth and seasonal snowfall. They cautioned users that the data did not reflect conditions typical of western mountain areas. Furthermore, the density and characteristics of retention of snow accumulations on roofs were based upon assumptions rather than actual measurements.

Snow surveys provide bases for estimating on-the-ground accumulation of snow in many localities. However, relations between snow depths measured on the ground and weight of snow accumulated on roofs need to be determined more precisely. Are increases in snow depth similar? How do melting rates and snow densities compare? To answer these and related questions, we measured

<sup>1</sup>Research Foresters at Forestry Sciences Laboratories at Logan, Utah, and Moscow, Idaho, maintained in cooperation with Utah State University and the University of Idaho.

<sup>2</sup>Housing and Home Finance Agency, *Snow Load Studies*, Housing Research Paper 19, 19 pp., 1952. Boyd, D. W., *Maximum Snow Depths and Snow Loads in Canada*. Western Snow Conf. Proc., April 1961. Colo. State Univ., Fort Collins, Colo., pp. 6-16, 1961.

accumulations of snow on a roof and on the ground nearby at the Priest River Experimental Forest during a 6-week period in February and March 1964.

### SITE AND MEASUREMENTS

We selected an unheated, open-front garage as the site for a series of comparative snow measurements on a cedar-shingled roof and on nearby ground locations having less slope but similar exposures (fig. 1). Information on snow loads from other buildings was limited to visual observations. The snow on each side of the garage roof was sampled at points 30 inches below the ridge and 30 inches

above the eaves. The snow on each ground location was also sampled at two points. We used conventional snow survey techniques to measure depth and determine water content at all measuring points. Orientation of the sample points was:

Location	Aspect	Slope percent
Roof	N70°E	53
	S70°W	60
Ground	N60°E	27
	S90°W	32



Figure 1.—Garage where snow accumulation was measured. Depth near eaves was about 40 inches on March 12, 1964.

### RESULTS AND DISCUSSION

We started measuring snow depths on February 19, 1964. Until then, the seasonal snowfall had been somewhat below average. Several warm days (maximum temperatures exceeding 40° F.) followed by cold nights (minimum temperatures of 10° to 20° F.) preceded the second measurement date, February 27. During the following period snow fell almost every day, and by March 11, 17 inches of new snow had been recorded at the Experimental Forest. From March 12 until the final measurement date, March 31, precipitation was scanty and the temperature trend was upwards.

The properties of accumulated snow on different parts of the garage roof were affected somewhat by aspect, especially on the last date of measuring (figs. 2 & 3). During the period from March 11 to March 31, local air currents apparently caused heavier snow deposit on the west side and a somewhat faster melting rate on the east side of the building. Snow depth increased slightly from ridge to eaves: points near the eaves averaged 2 inches deeper. This difference probably resulted from snow creep down the roof slope.

Depth and water content of snow on the ground were similar to those measured on the roof. Although the depth of snow on the



ground averaged about 2 inches less, its density was about 3 percent higher; so the actual water contents were essentially the

same.<sup>3</sup> Heat conducted from the unfrozen earth was probably responsible for the increased density.

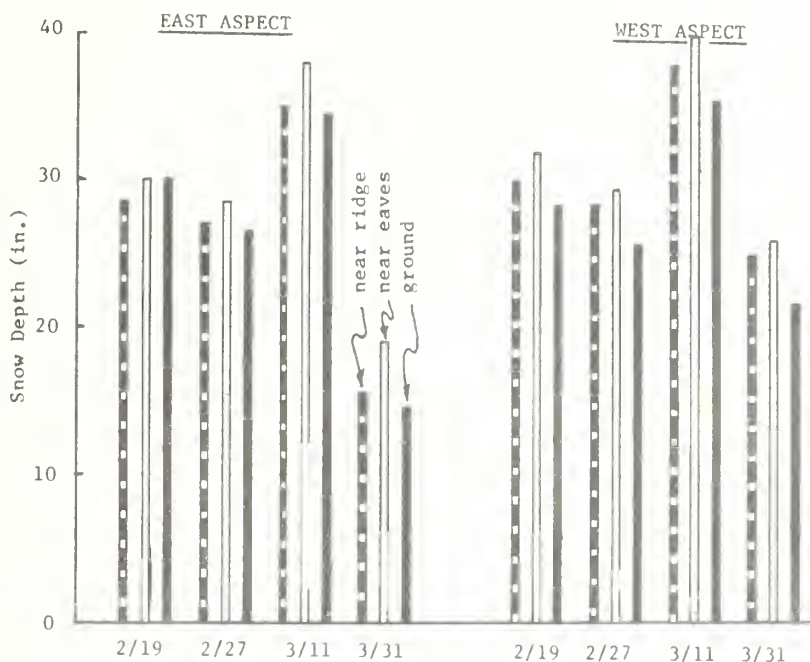

Figure 2.—Depth of snow at ridge and eaves of garage roof and on the ground, by aspect and date of measurement.

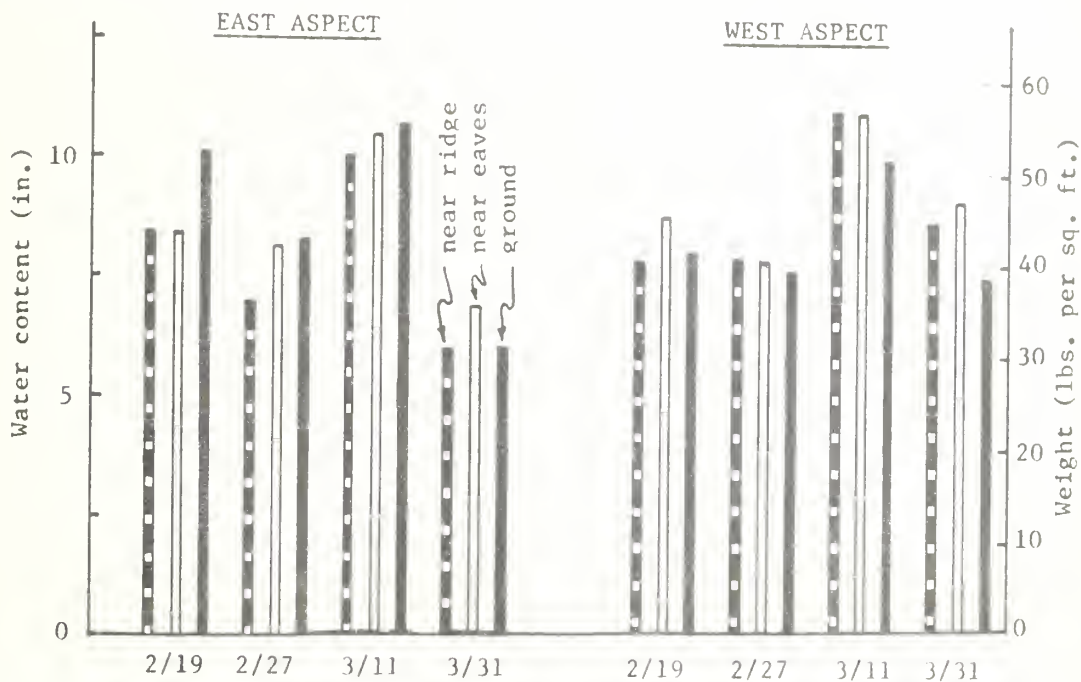

Figure 3.—Water content and weight of snow at ridge and eaves of garage roof and on the ground, by aspect and date of measurement.

<sup>3</sup>Snow density is computed as the snow depth (in inches) divided by the water content (in inches), and is expressed in percent. Densities during the 6-week period of measurement ranged from 26 to 42 percent.

Observations of the characteristics of snow retention on the roofs of nearby buildings indicated that wood-shingled roofs of heated buildings also can accumulate heavy loads of snow. Formation of ice at the eaves frequently adds weight stress on the overhang portion (fig. 4).

We also noted behavior of snow on aluminum-shingled roofs of unheated buildings. On these roofs, considerable snow accumulates even where the pitch of the roof is moderate. Cohesive strength of the snowpack over the ridge or over other roof projections tends to hold the snow for extended periods. However, warming temperatures usually cause the

snow to slip quickly from aluminum-shingled roofs (fig. 5).

The maximum water content of 10 to 11 inches, reached on March 11, was nearly as great as has been recorded on a nearby snow course during nearly 30 years of measurement. This corresponds to a weight of about 55 pounds per square foot of horizontal area; thus a building having 800 square feet of roof area would need to support a total snow load of 22 tons. This is not especially heavy for many mountainous areas. At a snow course near the Deception Creek Experimental Forest headquarters, for example, snow depths exceeding 6 feet, with water content of more than 30 inches, have been measured.



Figure 4.—Ice usually accumulates at the edge of overhanging eaves of heated buildings (photographed March 12, 1964).



### CONCLUSION

Although the depth and density of snow on wood-shingled roofs of unheated buildings may vary slightly from depth and density of snow on the ground, the weight per unit of horizontal area of snow on the roof will cor-

respond closely to that of the snowpack on the ground. Consequently, past records of snow surveys can be useful references for determining the snow load a building may need to sustain.

Figure 5.—Snow slid from the aluminum-shingled roof of this unheated building at Priest River Experimental Forest shortly after a period of warmer weather began (photographed March 5, 1964).



# Research Note

UNITED STATES DEPARTMENT OF AGRICULTURE  
FOREST SERVICE

INTERMOUNTAIN FOREST & RANGE EXPERIMENT STATION  
OGDEN UTAH

U.S. Forest Service  
Research Note INT-44



1966

## EVALUATING GROWTH PERFORMANCE OF YOUNG STANDS

A. L. Roe and R. E. Benson<sup>1</sup>

### ABSTRACT

A simple procedure for evaluating the diameter growth of young stands in relation to potential growth is described. A comparison technique is developed which contrasts relative diameter of crop trees to the relative diameter growth of the last decade to show the condition and trend of growth in the stand. The method is objective, easy to use, and has several applications such as: (1) determining relative growth performance of trees and stands, (2) confirming the need for thinning and setting of priority among stands, and (3) determining the growth impact of disease and other growth depressing agents. The technique does not replace more complex, precise methods of growth study.

### INTRODUCTION

"How does the growth performance in this stand measure up?" This question is frequently asked by foresters when they examine young stands. To answer this question, the forester often makes some simple diameter measurements and an increment boring or two in the stand and rates stand performance as good, fair, or poor, according to his judgment of how fast such a stand should grow. This rating of relative stand growth performance is highly subjective, but the forester often cannot spend the time to estimate stand growth objectively using more complex measurements.

This paper presents a simple technique for objectively evaluating the growth performance of young stands by contrasting actual growth with a standard of potential growth. The concept is easy to use, requires relatively few measurements, and quickly provides substantial information about growth of individual trees and entire stands.

---

<sup>1</sup> Principal Silviculturist and Marketing Analyst, respectively, at the Intermountain Forest and Range Experiment Station, Missoula, Montana.

## ESSENTIALS OF THE TECHNIQUE

Potential growth.--Individual trees of a given species on a given site quality have the potential to achieve a certain growth rate. Growth rates of trees that have sufficient space to grow rapidly and at the same time do not develop excessive limbiness provide a practical standard for estimating potential growth.<sup>2</sup>

To understand the condition and trend of growth either in individual trees or stands, two growth elements must be dealt with as follows:

1. Relative diameter is determined by comparing the tree's actual diameter with its potential diameter; it shows how well the tree has grown from seed to its present age.

2. Relative growth rate is determined by comparing the tree's last 10-year growth with its potential decadal growth; it shows the tree's present performance.

Comparing relative diameter with relative growth rate illustrates the trend of growth. For example, if the relative diameter is 90 percent of potential but the relative growth rate is only 50 percent of potential, the tree has performed well up to the present decade, but it has started a downward trend in growth.

Potential curves for western larch are shown below. In figure 1A, curve "Pg" shows the potential diameter growth (in inches per decade) for western larch, site index 70. In figure 1B "Pd" is the potential diameter in inches, outside bark (or sum of all past growth) for larch, site index 70.

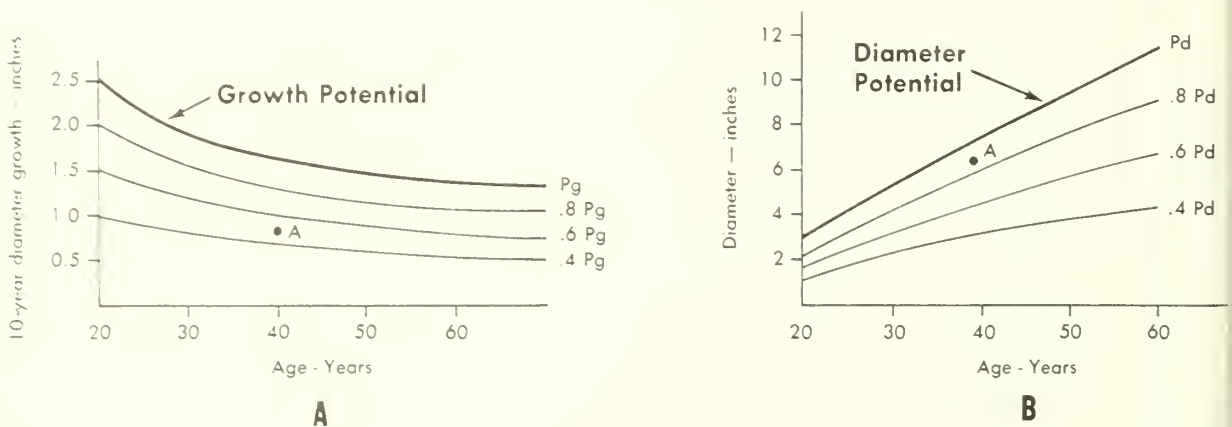

Figure 1.--Growth and diameter potentials for western larch, site index 70.

<sup>2</sup> This is an arbitrary growth standard. The Intermountain Forest and Range Experiment Station is developing potential growth curves that relate growth rate to tree age, stocking, and other environmental factors. The technique described in this paper could be used with any growth curve selected as a standard.

## GROWTH POTENTIAL CLASS AND DIAMETER POTENTIAL CLASS

Dividing the range of performance into classes facilitates classifying trees and summarizing tree measurements. In figures 1A and 1B, curves are plotted at 0.8, 0.6, and 0.4 of the potential 10-year growth and potential diameter, respectively. These curves divide performance or achievement of the potential into four classes:

### Potential class

- >0.80
- 0.60-0.79
- 0.40-0.59
- <0.40

The above classes provide a tool with which the forester may classify a tree without calculating the ratio of actual growth to potential growth. To illustrate, the actual growth of tree A plotted in figure 1A falls between 0.40 and 0.60 of potential 10-year growth: the growth potential class of tree A is 0.40 to 0.59. Similarly, figure 1B shows that the present diameter of tree A is greater than 0.80 of potential diameter: the diameter potential class of tree A is >0.80.

### COMPARING GROWTH OF INDIVIDUAL TREES

Potential classes permit comparison of trees even though they are different species, have different ages, and occur on lands of different site quality. Figure 2 compares the growth of two western larch trees (A and B), aged 40 and 50 years, growing on site index 70 land, with three grand fir trees (C, D, and E), aged 30, 47, and 55 years, respectively, growing on site index 80 land. The growth potential classification of these trees is: tree D, >0.80; trees B and C, 0.60 to 0.79; tree A, 0.40 to 0.59; and tree E, <0.40. Diameters of individual trees can be similarly compared using diameter potential classification.

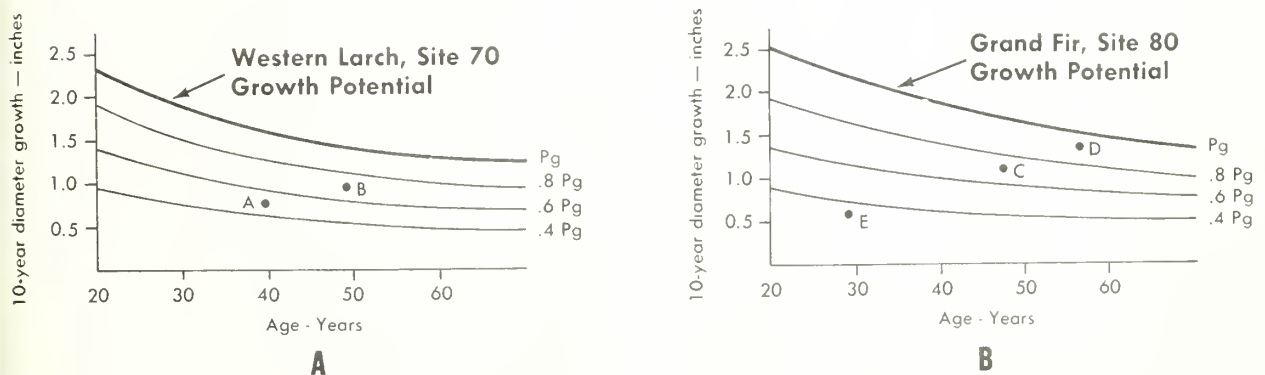

Figure 2. --Comparing growth of trees using potential curves. (Curves for western larch are drafted from unpublished data in Intermountain Forest and Range Experiment Station files. Curves for grand fir are hypothetical and are used only for illustration.)

## DISTRIBUTION OF GROWTH IN STANDS

Classifying trees by growth potential class shows the distribution of growth performance within the stand. This is not provided by actual growth measurements. For example, assume the five trees from figure 2 are sample trees from a mixed stand of western larch and grand fir. The actual growth of each tree and the average growth of all five trees are shown in table 1, column I. These growth measurements do not reflect the difference in growth potential by species and age. However, values in columns II and III do show growth values in relation to species and age potential, and the distribution of growth in the stand. The distribution can be shown either as frequency of number of trees, as in column III, or in percent, as in column IV.

Table 1. --Growth potential classification of sample trees

Tree	I Growth Inches	II Growth potential class	III Class frequency Number of trees	IV Class frequency Percent
D	1.5	> 0.80	1	20
B, C	1.0, 1.2	0.60-0.79	2	40
A	0.7	0.40-0.59	1	20
E	0.6	<0.40	1	20
Total	5.0			
Average	1.0			

The trend of growth in a stand is revealed by comparing present growth performance to past growth performance. Under natural conditions, trees usually begin growing at or near their potential rate. As the stand ages, crowding may cause individual trees to grow more slowly. One way to recognize this slowdown in growth is to compare growth potential class and diameter potential class frequencies. The tabulation below shows 88 percent of the trees in the stand are in diameter potential class >0.80; this means that for most of its life this stand grew at or near its full potential. But, during the past decade growth has slowed down as shown by the shift of trees into lower potential classes. Growth of more than half the trees is now in the two lowest potential classes.

<u>Potential class</u>	<u>Diameter potential frequency (percent)</u>	<u>Growth potential frequency (percent)</u>
>0.80	88	12
0.60-0.79	6	35
0.40-0.59	6	35
<0.40	0	18

If the downward trend continues because of overstocking, we can expect a greater proportion of trees in the lower growth potential classes in the future. Eventually the slowdown in growth will also be reflected in a downward shift in diameter potential class distribution.

## COMPARING STANDS

Evaluating condition and the trend of growth in stands is one of the important tasks facing the land manager as he develops his work program. He must (1) determine if the stand needs silvicultural treatment, and (2) set priorities among stands requiring treatment. The comparison technique employing the distribution of tree diameter and 10-year diameter growth in potential classes provides an objective tool to use for evaluating the stands.

### DETERMINING NEEDS FOR TREATMENT

The extent to which the diameter and growth rates of trees have achieved their potential reflects the degree of competition in the stand and, in turn, the need for treatment.

For example, stands A and B shown below have made good past growth; in both stands, all trees are in the upper two diameter potential classes. But there is a considerable difference in trend of growth in these stands. Stand A has maintained good growth as indicated by a high proportion of trees in the upper two 10-year growth potential classes. In stand B, however, growth is declining more rapidly than in stand A, as shown by the higher proportion of trees in the lower growth potential classes. This declining growth shows the effect of overstocking in stand B, which has 470 trees per acre. The manager would conclude that this stand needs thinning.

Table 2. -- Comparing growth performance, stands A and B

Potential class	Stand A		Stand B	
	Diameter	Growth	Diameter	Growth
	potential	potential	potential	potential
----- Percent -----				
>0.80	63	56	70	0
0.60-0.79	37	25	30	25
0.40-0.59	0	12	0	37
<0.40	0	7	0	38

## SETTING PRIORITIES FOR TREATMENT

After the land manager has determined whether stands need treatment, he still may need to decide which stand he is going to treat first. The diameter potential classes in stands B and C below show that neither stand has had a history of long suppression. In both stands growth is now declining, as shown by the downward shift of trees in 10-year growth potential classes. This indicates both stands are suffering from some degree of overstocking. However, stand B shows a more severe growth decline because the 10-year growth rates of about three-fourths of the crop trees fall in the lower two potential classes, as compared to stand C where only about 40 percent of the trees are found in the lower two classes. From this comparison the manager may conclude that in stand B more crop trees would benefit by removal of excess trees.

Table 3.--Comparing growth performance, stands B and C

Potential class	Stand B		Stand C	
	Diameter potential	Growth potential	Diameter potential	Growth potential
	----- Percent -----			
>0.80	70	0	75	9
0.60-0.79	30	25	20	50
0.40-0.59	0	37	5	33
<0.40	0	38	0	8

## EVALUATING EFFECTS OF TREATMENT

The comparison technique reveals stand dynamics and to this extent it is useful in evaluating the effect of thinning. For example, in the stand described by the tabulation below, which was thinned 10 years ago,<sup>3</sup> nearly one-half of the trees are in the lower two classes, showing considerably depressed growth in the past. However, examination of the frequencies of 10-year growth potential rates shows that most trees are now achieving growth at or near the potential rate. In fact, about 80 percent of the trees are in the upper two potential classes; this points to a substantial response to crop-tree thinning.

<u>Potential class</u>	<u>Diameter potential</u> (percent)	<u>Growth potential</u> (percent)
>0.80	20	60
0.60-0.79	32	20
0.40-0.59	43	12
<0.40	5	8

<sup>3</sup> Approximately 175 dominant and codominant western larch trees of good form and free from visible defect were left after thinning.



## THE TECHNIQUE IN PRACTICE

This technique can be used in any sampling method such as plot, strip, and random selection where tree age, diameter, and growth measurements are made. The only requirement is that enough trees be included in the sample to show the distribution of trees among potential classes. In some of the examples we have used only a few trees to simplify the illustration. Usually at least 25 trees would be included in a sample, and in some cases more may be required to accurately reflect distribution of trees in potential classes.

Usually the manager is primarily concerned with condition and trend of the crop trees in a stand. Therefore, the technique should be applied to crop trees or that portion of the stand that will be featured in management. Obviously, including trees that would not be considered in management would merely tend to distort the picture by skewing the distribution into lower potential classes.

This technique has several uses. In the preceding examples we have illustrated its use in detecting overcrowding and setting priorities for thinning. In addition, it can be used to measure other factors such as release from overstory or the impact of insects, disease, and other growth-depressing agents.

The technique is intended primarily as a convenient management tool that can be readily used with simple field measurements. It does not replace the more sophisticated analysis techniques used in making timber inventories, planning allowable cuts, or similar activities.

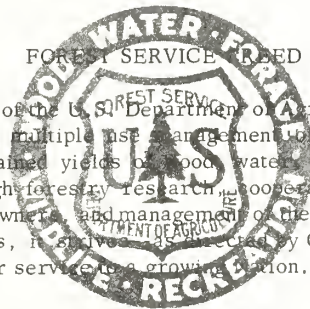

The Forest Service of the U.S. Department of Agriculture is dedicated to the principle of multiple use management of the Nation's forest resources for sustained yields of wood, water, forage, wildlife, and recreation. Through forestry research, cooperation with the States and private forest owners, and management of the National Forests and National Grasslands, it strives to provide increasingly greater service to the growing Nation.





# Research Note

UNITED STATES DEPARTMENT OF AGRICULTURE  
FOREST SERVICE

INTERMOUNTAIN FOREST & RANGE EXPERIMENT STATION  
OGDEN

U.S. Forest Service  
Research Note INT-45

1966

## CONTROLLING SOIL MOVEMENT FROM STEEP ROAD FILLS

Nedavia Bethlahmy and W. Joe Kidd, Jr.<sup>1</sup>

### ABSTRACT

Eight test plots were established on the fill slope of a newly constructed road. One plot was retained as a control, while different soil-stabilizing treatments were used on each of the other plots. These consisted of various combinations of seeding, fertilizing, mulching, and surface netting. Treatments that included both straw mulch and netting effectively controlled erosion.

Bogus Basin road is a two-lane highway on the Boise National Forest leading from Boise, Idaho, to the Bogus Basin ski resort. The highway traverses steep terrain, the soils of which are typical of those derived from the loose, weathered, granitic material of the Idaho batholith. This material erodes readily and poses a problem to those concerned with stabilizing road fills.

In the fall of 1962, eight contiguous test plots--each 43.6 feet in length--were established on a raw fill slope by inserting planks at 10-foot intervals into the ground (fig. 1). The slope had an average gradient of 80 percent on a southeast exposure at an elevation of 5,650 feet. A sediment catchment trough was placed at the bottom of each plot (fig. 2).

<sup>1</sup>Bethlahmy, who was project leader of the Station's watershed management project at Boise, Idaho, accepted an FAO assignment in Taiwan in July 1966, while Kidd is still assigned to the project. Both are research foresters. Field installations were made under the direction of District Ranger Jack M. Wilcock, Boise National Forest.



Figure 1. --Overall view of the test plots that were established on a steep fill slope on the Bogus Basin road.

### PROCEDURE

The plots were numbered consecutively. Plot 1 was left untreated to serve as a control, while the remaining plots were treated as follows:

<u>Plot number</u>	<u>Sequence of treatment</u>
1	Control--no treatment at all.
2	Contour furrows, seed, fertilizer, holes.
3	Contour furrows, straw mulch, seed, fertilizer, holes.
4	Polymer emulsion, seed, fertilizer.
5	Straw mulch, paper netting, seed, fertilizer.
6	Straw mulch, jute netting, seed, fertilizer.
7	Seed, fertilizer, straw mulch, chicken wire netting.
8	Seed, fertilizer, straw mulch with asphalt emulsion.

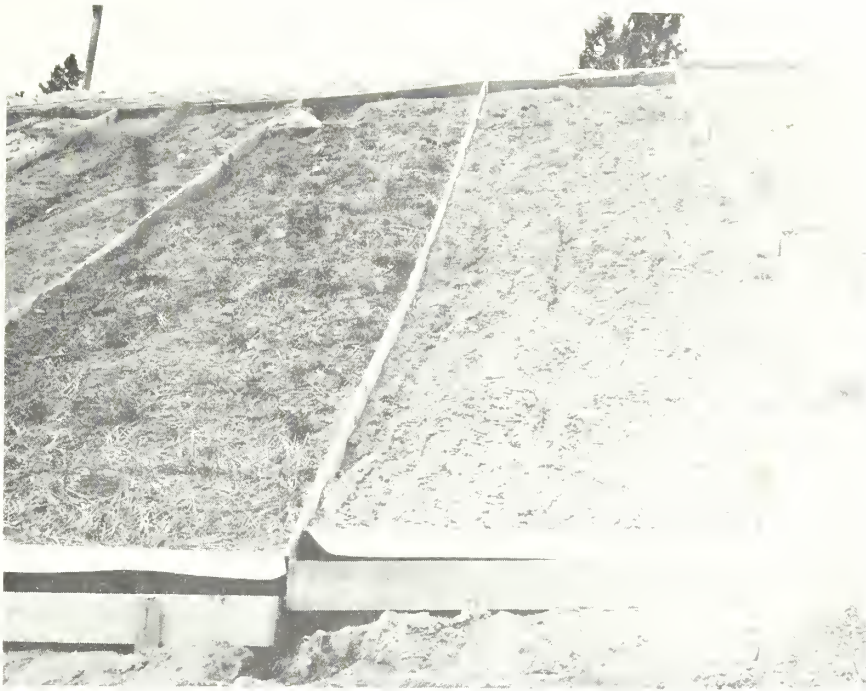

Figure 2.--Closeup view of test plots showing side baffles and the sediment-collecting trough at the bottom of plot.

The contour furrows plowed on plots 2 and 3 were spaced 6 feet apart and the holes on these two plots were punched 2 inches deep at 6-inch intervals. The straw mulch used on all but plots 2 and 4 was applied at a rate of 2 tons per acre. The polymer emulsion used on plot 4 consisted of 1 gallon "soil set" to 9 gallons of water; one half was sprayed before the seeding and fertilizing and one half after. The asphalt emulsion used on plot 8 was applied at the rate of 300 gallons per acre. All three types of netting--plots 5, 6, and 7--were fastened to the ground with staples made of 12-inch pieces of No. 9 wire.

The amount of soil eroded from each of the plots was weighed six times during the following 11 months. The first weighing was done on December 10, 1962--17 days after the plots were installed--and the last on October 11, 1963. Table 1 gives the cumulative results of these weighings.

Table 1. -- Comparison of cumulative erosion from treated plots on a steep road fill  
(in 1,000 lbs. per acre)

Cumulative elapsed time: (days)	Cumulative precipitation	Control plot	Group A (seed, fertilizer)		Group B (seed, fertilizer, mulch)		Group C (seed, fertilizer, mulch, netting)		
			2	4	3	8	5	6	7
<u>Inches</u>									
17	1.41	31.9	38.7	38.0	0.1	32.6	0	0	0
80	4.71	70.0	99.2	85.7	7.4	34.6	0.9	0	0.3
157	12.46	72.2	100.2	86.9	11.1	35.1	1.1	0	0.4
200	15.25	79.1	101.0	87.6	11.4	35.7	1.1	0	0.4
255	17.02	82.3	102.8	88.8	11.5	35.8	1.1	0	0.4
322	20.40	84.2	104.7	89.4	11.9	36.0	1.1	0	0.4

### DISCUSSION AND CONCLUSIONS

The seven treated plots were classified into the following groups based upon the elements used in the treatments:

<u>Group</u>	<u>Plot number</u>	<u>Common elements</u>
A	2,4	Seed and fertilizer
B	3,8	Seed and fertilizer plus straw mulch
C	5,6,7	Seed and fertilizer plus straw mulch plus netting

The average amounts of eroded material (in 1,000 lbs./acre) from each of these groups and their associated standard errors were: Group A,  $97.1 \pm 7.3$ ; Group B,  $24.0 \pm 12.0$ ; and Group C,  $0.5 \pm 0.3$ .

Most of the erosion on the fill slope occurred during the first 3 months; thereafter, the rate of erosion declined markedly. As grass became established, the rates of erosion declined. Obviously, Group C plots had less erosion than plots in the other groups. The netting bound the mulch snugly to the soil, thus minimizing erosion by overland flow. Mulching prevented soil splash as a result of raindrop impact. Thus, erosion was checked during the time when the raw slope was most vulnerable as well as after the grass became established.



# Research Note

UNITED STATES DEPARTMENT OF AGRICULTURE  
FOREST SERVICE

INTERMOUNTAIN FOREST & RANGE EXPERIMENT STATION  
OGDEN

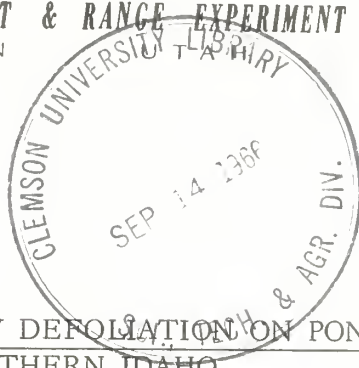

U.S. Forest Service  
Research Note INT-46

1966

## EFFECT OF PINE BUTTERFLY DEFOLIATION ON PONDEROSA PINE IN SOUTHERN IDAHO

Walter E. Cole, Research Entomologist

### ABSTRACT

The shortcut sampling technique, derived from Duff and Nolan's two-level sampling technique for the vertical growth sequence, is applicable to ponderosa pine of all ages. Growth loss due to pine butterfly defoliation is calculated and the effect of control in 1954 is compared to no control of the 1922-23 pine butterfly epidemic.

An outbreak of pine butterfly, Neophasia menapia (F. & F.), developed in 1950 on the Boise National Forest in southern Idaho. By 1953, approximately 169,000 acres of ponderosa pine type were severely defoliated. The timber loss during past epidemics shows that pine butterfly is a tree killer. In 1893-96, approximately 1,500,000 acres of ponderosa pine were affected and 20 to 90 percent of the stands were killed (Hopkins 1907); in 1922-23, on approximately 27,000 infested acres, 26 percent of the trees were killed (Evenden 1940); and an estimated 255,400 acres were ultimately affected between 1952 and 1954 (U.S. Forest Service 1954). Under ordinary conditions, butterfly larvae feed only on the older needles; but under epidemic conditions they may eat both new and old needles.

Aerial spraying in 1954, the peak year of the epidemic, reduced the infestation to an endemic level, and thus interrupted the so-called normal trend of the epidemic.

This study to determine the effects of defoliation on ponderosa pine was completed in 1959, when it was felt that sufficient time (5 years) had elapsed since the epidemic was controlled to allow for tree mortality attributable to the infestation.

## OBJECTIVES

Objectives of this study were threefold: (1) to determine the effect of defoliation on increment before and after control of the epidemic; (2) to determine percent mortality of ponderosa pine caused by defoliation; and (3) to determine economic loss due to the pine butterfly.

Data from this study on tree mortality and loss of volume are compared with data from Evenden's study (1940). The important difference between these two epidemics is that the 1922-23 epidemic ran its course and was finally controlled by natural factors, primarily the ichneumonid, Therionia atalantae (Poda), while the 1952-54 epidemic was chemically controlled at its peak.

## METHODS AND PROCEDURE

In the study reported here, determination of growth reduction in ponderosa pine defoliated by the pine butterfly was based on Duff and Nolan's (1953) approach to the study of growth in conifers and on a shortcut sampling technique for growth analysis by Stark and Cook (1957)--developed from Duff and Nolan's work. Mott (1957) gave brief descriptive names to Duff and Nolan's numerically designated growth sequences: oblique, radial, and vertical. The type 3, or vertical sequence, was used in the present growth analysis study. Two discs were cut from the bole of each tree felled for study. One disc shows the normal decrease in growth during several years; the other shows damage attributable to the recent epidemic.

Cole (1958) found that the shortcut sampling technique was applicable for separating external growth influences (Stark and Cook 1957) and was applicable to the growth analysis of ponderosa pine.

During 1959, 40 trees were felled and 2 discs were cut from each according to the vertical sequence technique. The trees were selected on the basis of percent defoliation; all trees selected had suffered at least 25 percent defoliation (table 1).

Table 1.--Distribution of study trees, 1959<sup>1</sup>

Area	Total no. of trees	D.b.h. range	Defoliation class								Total volume	Average volume
			25-50%		50-75%		75-90%		> 90%			
			No.	Vol.	No.	Vol.	No.	Vol.	No.	Vol.		
Banner	14	16-40	3	3.84	6	7.16	4	6.08	1	0.96	18.04	1.29
Beaver	14	20-42	1	0.55	5	5.66	4	6.68	4	5.30	18.19	1.30
Swanholm	12	16-40	0	0.00	5	4.29	4	4.48	3	3.37	12.14	1.01
Totals	40	16-42	4	4.39	16	17.11	12	17.24	8	9.63	48.37	
Averages		29.10		1.10		1.07		1.44		1.20		1.21

<sup>1</sup> Volume based on 1,000 bd. ft.



## ANALYSES AND RESULTS

Two-level growth sequence curves were first plotted for the individual trees. The results appeared to conform to the basic principles of the vertical sequence technique for separating external growth influences from inherent growth characteristics (Duff and Nolan 1953).

Graphs were then plotted for all trees within each defoliation class (figs. 1-4).

The mean annual radial increment for the predefoliation period of the base discs and damage discs was almost equal (table 2). The "t" test revealed no significant difference between these means at the 99-percent confidence level.

The common growth basis of the predefoliation periods gives greater strength to the subsequent analysis of variance. It also follows that the vertical sequence using the two-level, two-disc technique is applicable for comparison when the increment is measured as years from pith.

Table 2. -- Comparison of means, sampling errors, and coefficients of variation of radial growth (mm) of the base discs with those of the damage discs

Discs	Defoliation periods					
	Before		During		After	
	Base	Damage	Base	Damage	Base	Damage
Sum	27.717	28.779	23.675	14.836	21.872	12.810
$\bar{x}$	<sup>1</sup> 0.770	0.799	0.658	0.412	0.608	0.356
SE $\bar{x}$	0.066	0.087	0.085	0.051	0.081	0.043
C. V.	8.15%	10.89%	12.92%	12.38%	13.32%	12.08%

$$^1 t = 0.770 < t_{.01} = 2.724 \text{ on } 35 \text{ d.f.}$$

The ultimate sampling unit was the average radial growth (in millimeters) per period, per disc, per tree. The variance component technique was used in determining error mean squares to test for growth differences in the analysis of variance. Because of an error in cutting, the 25-50 percent defoliation class was not represented within one plot; so only the 36 trees in the upper three defoliation classes were used in this test.

Significant differences in growth occurred between areas, defoliation classes, curves (base and damage), and between periods of defoliation. A significant growth difference in the area × defoliation interaction was of little consequence to this study. This significant difference indicated only that growth within each defoliation class varied between areas.

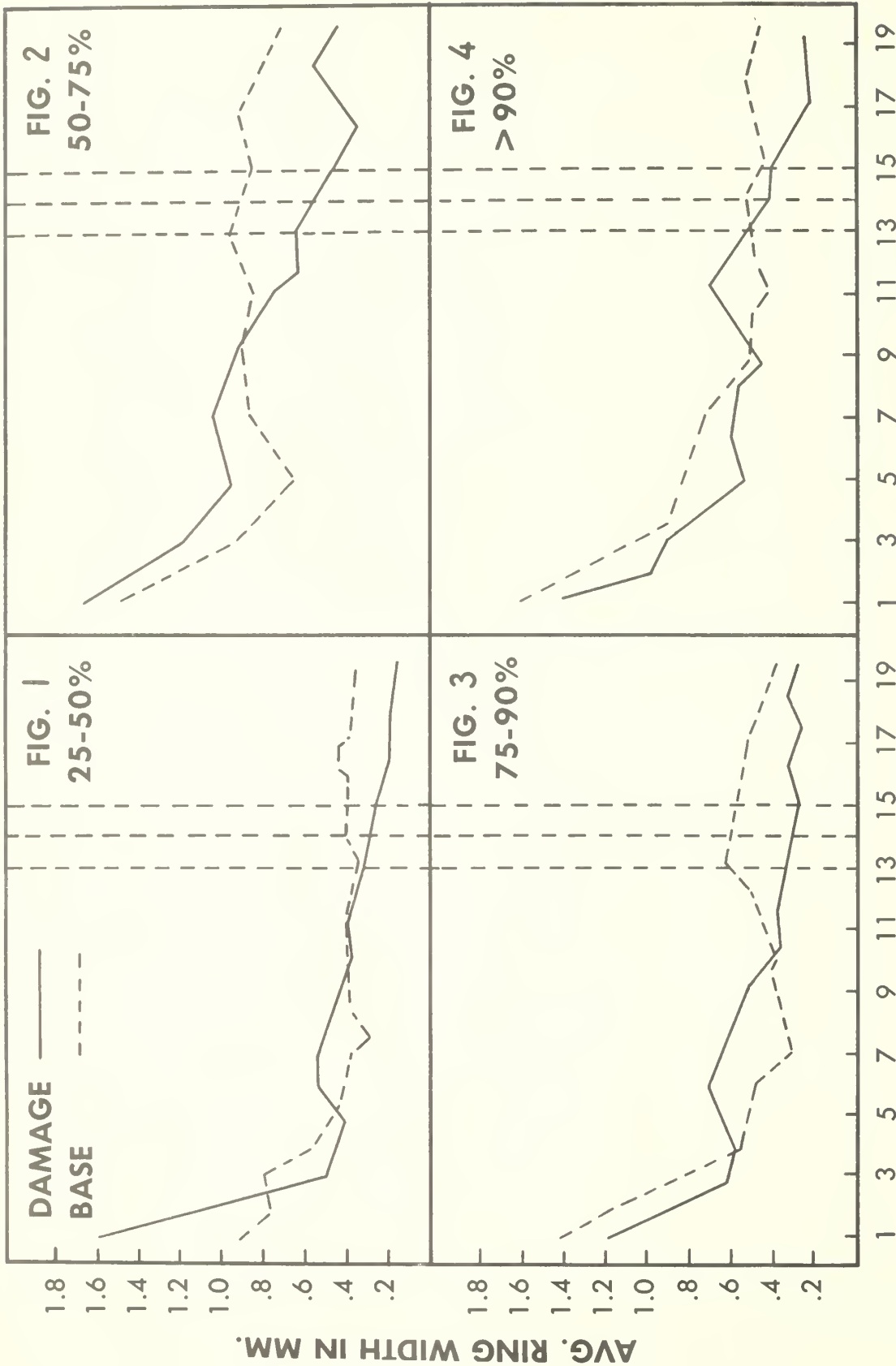

**YEAR OF RING FORMATION FROM PITH**

Figures 1-4. --Two-level growth sequence curves of ponderosa pine by defoliation class (vertical dashed lines indicate years of defoliation).

Growth differences between base and damage curves and between the periods (before, during, and after defoliation) were of chief interest. Independent comparisons revealed that rate of growth before defoliation was significantly different from the amount of growth during and following defoliation combined. Significant growth differences might possibly have been shown by the interaction, curves × periods, if a much larger sample had been taken, e.g., 100 trees instead of 36.

The magnitude of the pine butterfly's effect on tree growth was measured on the basis of a common mean of the period before defoliation for both discs, and based on the results of the independent comparison. To illustrate how this percent of growth loss could be estimated, growth data were taken from W. H. Meyers' (1934) work. The figure of 183.3 bd. ft. (site IV) was used as an example of the annual increase per acre for an area stocking 16,000 bd. ft. per acre. It was assumed that the annual increase of 183.3 bd. ft. would have continued for the period under study.

Mean annual growth (mm) before, during, and after defoliation was 0.785, 0.633, and 0.384, respectively. If this growth difference represents the normal decrease in growth over the years (base discs), the annual loss due to the pine butterfly would be 39.34 percent of the normal increment since 1952. On the basis of Meyers' figure--183.3 bd. ft.--a loss of 72.1 bd. ft. per acre per year occurred.

Loss due to tree mortality in 1952-54 was extremely small compared to that in the 1922-23 epidemic (table 3).

Table 3.--Comparison of magnitude and causes of tree mortality in the 1922-23 pine butterfly epidemic with those of the 1952-54 pine butterfly epidemic

Epidemic period	Number study		Trees killed by						Volume	
	years after	Study	Defoliation		Bark beetles		Total		(1,000 bd. ft.)	
	defoliation	trees	No.	Pct.	No.	Pct.	No.	Pct.	Amt.	Pct.
1922-23	10	100	12	12	14	14	26	26	--	36
	1st	5	100	7	7	13	13	20	20	--
1952-54	5	225	0	0	3	1.3	3	1.3	1.76	0.6

Comparison of the mean annual radial growth of study trees for the two epidemics is also interesting. Evenden's data (1940) are from basal measurements, whereas the data presented herein are from measurements at the internode where the disc was cut (table 4).

Table 4. -- Growth of trees that recovered within the epidemics:1922-23 and 1952-54

Epidemic period	Mean annual radial growth (mm)	
	5 years before	5 years after
	(1917-22)	(1923-28)
1922-23	0.940	0.377
	(1947-52)	(1954-59)
1952-54	0.785	0.384

SUMMARY

Defoliation by the pine butterfly can cause extensive mortality in pine stands. However, successful control of an epidemic by aerial spraying can nearly eliminate tree mortality. Even when epidemics are successfully controlled, defoliation can reduce growth to approximately 40 percent of the expected normal gain, as it did in this area.

The two-level sampling technique for the vertical growth sequence developed by Duff and Nolan is applicable to ponderosa pine for comparison of growth rates when the increment is measured by years from pith.

The shortcut sampling technique for the vertical growth sequence is applicable to ponderosa pine of all ages. The comparisons from these growth rate data are reliable on a 99-percent confidence level, provided enough samples are taken. In this study, 40 trees were adequate, but the author believes that a minimum of 100 trees should be used for maximum reliability of independent comparisons within the interactions.

The difference in radial growth during the three periods (before, during, and following defoliation) was statistically significant. There was a highly significant difference in mean annual radial growth between the 12-year period before defoliation (1940-52) and the 8-year period during and after defoliation (1952-59).

Defoliation caused reduction of growth by 39.34 percent of the estimated normal growth increment. Since the normal annual volume increase per acre for the site, age, and stocking was estimated at 183.3 bd. ft. per acre, the annual growth loss would be 72.1 bd. ft. per acre.

Tree mortality resulting from the 1952-54 epidemic equaled 1.3 percent of the stand, or 0.6 percent of the volume; comparable tree mortality losses from the 1922-23 epidemic were 26 and 36 percent.

Mean annual radial growth of the study trees of the 1922-23 epidemic was approximately equal to that of the study trees of the 1952-54 epidemic.

### LITERATURE CITED

Cole, W. E.

1958. The effect of pine butterfly defoliation on ponderosa pine in southern Idaho. Intermountain Forest and Range Exp. Sta. (Progress Report.)

Duff, G. H., and N. J. Nolan.

1953. Growth and morphogenesis in the Canadian forest species. Part 1, Can. J. Bot. 31:471-513.

Evenden, J. C.

1940. Effects of defoliation by the pine butterfly upon ponderosa pine. J. Forest. 38: 949-955.

Hopkins, A. D.

1907. Notable depredations by forest insects. U.S. Dep. Agr. Yearbook 1907: 149-164.

Meyers, W. H.

1934. Growth in selectively cut ponderosa pine forests of the Pacific Northwest. U.S. Dep. Agr. Tech. Bull. 407.

Mott, D. G., L. D. Nairn, and J. A. Cook.

1957. Radial growth in forest trees and effects of insect defoliation. Forest Sci. 3: 286-304.

Stark, R. W., and J. A. Cook.

1957. The effects of defoliation by the lodgepole needle miner. Forest Sci. 3: 376-396.

U.S. Forest Service.

1954. Pine butterfly control, southwest Idaho, Boise National Forest, Region 4. (Project Report.)

#### **FOREST SERVICE CREED**

The Forest Service of the U.S. Department of Agriculture is dedicated to the principle of multiple use management of the Nation's Forest Resources for sustained yields of wood, water, forage, wildlife, and recreation. Through forestry research, cooperation with the States and private owners, and management of the National Forests and National Grasslands, it strives — as directed by Congress — to provide increasingly greater service to a growing Nation.



# Research Note

UNITED STATES DEPARTMENT OF AGRICULTURE  
FOREST SERVICE

INTERMOUNTAIN FOREST & RANGE EXPERIMENT STATION  
OGDEN UTAH

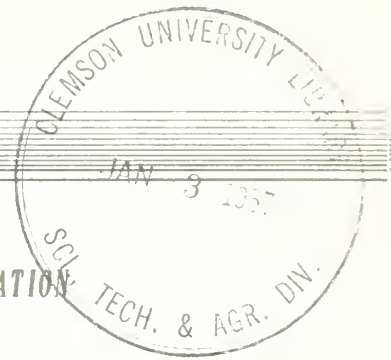

U.S. Forest Service  
Research Note INT-47

1966

## DIAMETER GROWTH OF WESTERN WHITE PINE FOLLOWING PRECOMMERCIAL THINNING

Glenn H. Deitschman<sup>1</sup>

### ABSTRACT

Precommercial thinning treatments of western white pine stands in northern Idaho were broadly classified as heavy thinnings and light-to-moderate thinnings. Data from periodic measurements of 35 plots, including unthinned control plots, were analyzed for differences in the diameter growth of potential crop trees. Only heavy thinning produced a significant response. Although the average diameter growth increase did not exceed .03 inch per year, stands thinned at 55 to 65 years of age have maintained this advantage for periods up to 40 years.

Periodic measurements of individual trees have been maintained for as long as 50 years on experimental thinning plots established in northern Idaho stands of the western white pine type. Most of these early studies were unreplicated, but recent analyses of combined data from some of the plots have provided helpful information on general characteristics of western white pine response to release.

From 1914 to 1935, a total of 35 plots ranging from one-tenth acre to one-half acre in size were set aside on the Priest River and Deception Creek Experimental Forests to test various methods and intensities of precommercial thinning. Thirteen of these were left unthinned to serve as control plots, while the remainder were treated as follows:

<u>Type of thinning</u>	<u>No. of plots</u>
Heavy thinning from above	5
Heavy thinning from below	6
Moderate thinning from above	3
Moderate thinning from below	4
Light thinning from above	1
Light thinning from below	3

<sup>1</sup> Research Forester, Intermountain Forest and Range Experiment Station, headquartered in Moscow, Idaho, at the Forestry Sciences Laboratory, which is maintained in cooperation with the University of Idaho.

In general, the heavy thinnings removed half or more of the basal area, and moderate or light thinnings took less than 40 percent. Ages of the stands at the time of thinning varied from 45 to 65 years old, except for one that was thinned heavily at 20 years of age and another that was thinned moderately at 33 years of age. Periods of recorded measurements ranged from 20 years in stands thinned at the earlier ages to 40 years in stands thinned at ages 55 to 65.

Average annual diameter growth was computed at 5- or 10-year intervals. For comparison of potential crop-tree development, only white pine trees among the largest 200 trees per acre were considered. The relations between the growth of these trees and their average diameter and the age of the stand were analyzed to determine the effect of thinning treatment (figs. 1 and 2). The regression equations used follow:

Heavy thinnings

$$Y = 0.236 - 0.0013 A; S_{\bar{y}} = 0.030$$

$$Y = 0.232 - 0.0096 D; S_{\bar{y}} = 0.029$$

Moderate and light thinnings

$$Y = 0.243 - 0.0018 A; S_{\bar{y}} = 0.017$$

$$Y = 0.262 - 0.0147 D; S_{\bar{y}} = 0.014$$

No thinning

$$Y = 0.204 - 0.0013 A; S_{\bar{y}} = 0.024$$

$$Y = 0.213 - 0.0103 D; S_{\bar{y}} = 0.024$$

where Y is the periodic mean annual growth of potential crop trees, D is the average diameter at breast height of the trees, A is stand age, and  $S_{\bar{y}}$  is the standard deviation from regression. D and A were about equally effective in accounting for variation of Y.

The downward trends in white pine growth (figs. 1 and 2) on both heavily thinned and unthinned plots were essentially at the same rate. This mainly reflects a continued benefit of heavy thinning in stands that were 55 to 65 years of age when thinned. Light and moderate thinning appeared to stimulate growth but this effect was short-lived; statistical analysis failed to show any significant difference between subsequent growth in light and moderately thinned plots and growth in the unthinned plots.

The white pine diameter growth in heavily thinned plots was significantly greater (at the 1-percent level of probability) than that in either lightly thinned or unthinned plots. But while the rate of growth averaged more than 20 percent above the rate of growth in unthinned plots, the actual magnitude of difference was only about .03 inch per year.

The results confirmed previous findings that western white pine trees in the dominant portion of second-growth stands respond to late release, but not aggressively.<sup>2</sup> Only thinnings that removed half or more of the stand basal area appeared to provide lasting benefits of consequence. The use of cleaning treatments in white pine stands before they are 20 years old, however, offers considerably more promise as a worthwhile means of accelerating growth.<sup>3</sup>

---

<sup>2</sup>Foiles, Marvin W. Effects of thinning a 55-year-old western white pine stand. J. Forest. 54: 130-132. 1956.

<sup>3</sup>Boyd, Raymond J. Cleaning to favor western white pine--its effects upon composition, growth, and potential values. J. Forest. 57: 333-335. 1956.



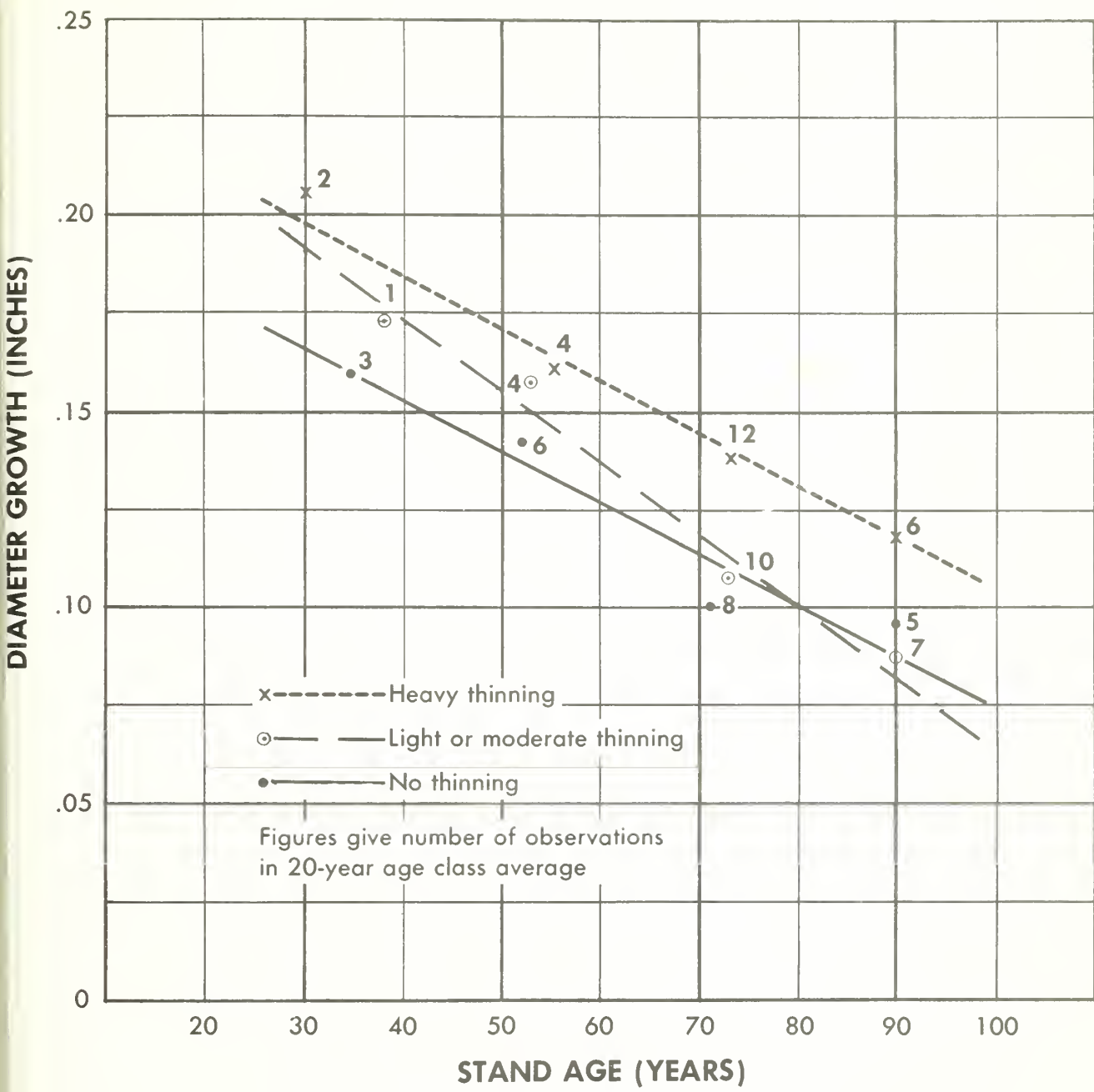

Figure 1.--Periodic mean annual growth in diameter of potential western white pine crop trees as related to stand age in heavily thinned, lightly to moderately thinned, and unthinned plots.

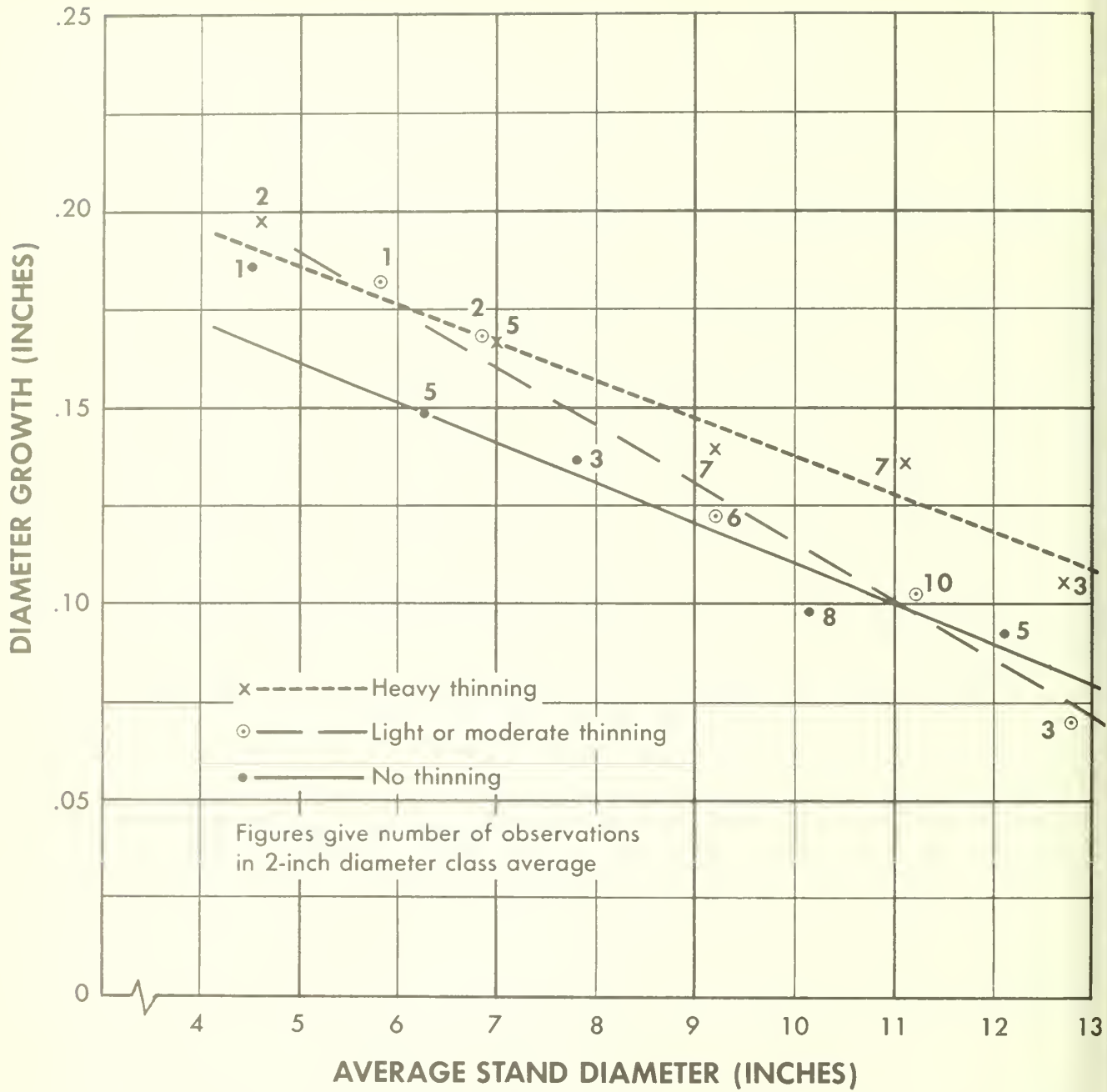

Figure 2.--Periodic mean annual growth in diameter of western white pine crop trees as related to average stand diameter at breast height in heavily thinned, lightly to moderately thinned, and unthinned stands.



# Research Note

UNITED STATES DEPARTMENT OF AGRICULTURE  
FOREST SERVICE

INTERMOUNTAIN FOREST & RANGE EXPERIMENT STATION  
OGDEN UTAH

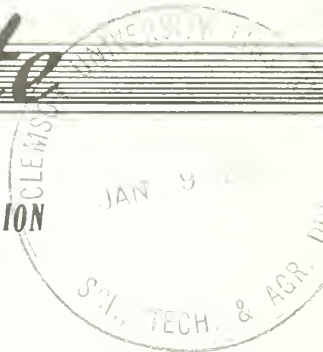

U.S. Forest Service  
Research Note INT-48

1966

A BIBLIOGRAPHY OF PUBLICATIONS BY THE INTERMOUNTAIN FOREST  
AND RANGE EXPERIMENT STATION ON THE GENETICS AND BREEDING  
OF FOREST TREES, 1921-1965

Compiled by Vendla K. Roberts

The articles listed in this bibliography are the results of forest genetics and tree breeding research done by staff members and cooperators of the Intermountain Forest and Range Experiment Station.

BAKER, F. S. 1921. Two races of aspen. J. Forest. 19: 412-413.

In Utah, two races of aspen (Populus tremuloides) commonly appear at middle and higher elevations. They are distinguished by differences in leafing time, in time of leaf falling, in general color of bark and leaves, and in quality of form. As yet, cause of these differences is unaccounted for.

BARNES, BURTON V. 1964. Self- and cross-pollination of western white pine: a comparison of height growth of progeny. Intermountain Forest and Range Exp. Sta., U.S. Forest Serv. Res. Note INT-22, 3 pp.

Comparison of height growth of progeny from self- and cross-pollinated western white pine shows that seedlings from self-pollinated parents usually show slower growth after outplanting than seedlings from cross-pollinated parents.

BARNES, BURTON V., and R. T. BINGHAM. 1962. Juvenile performance of hybrids between western and eastern white pine. U.S. Forest Serv., Intermountain Forest and Range Exp. Sta. Res. Note 104, 7 pp., illus.

At three sites in northern Idaho, two Pinus monticola X P. strobus hybrid progenies were approximately twice as tall and markedly excelled corresponding P. monticola progenies (having the same female parents) in height growth at 8 years. At one site in western Montana none of the few P. monticola, P. strobus, and hybrid progenies performed satisfactorily.

BARNES, BURTON V., and R. T. BINGHAM. 1963. Cultural treatments stimulate growth of western white pine seedlings. Intermountain Forest and Range Exp. Sta., U.S. Forest Serv. Res. Note INT-3, 8 pp., illus.

Describes an experiment to determine effectiveness of cultural treatments (cultivating, fertilizing, and watering in all possible combinations) in stimulating growth rate and inducing strobilus formation. Strobilus production was negligible, but striking differences in total height and diameter growth were attributed to the treatments.

BARNES, BURTON V., and R. T. BINGHAM. 1963. Flower induction and stimulation in western white pine. Intermountain Forest and Range Exp. Sta., U.S. Forest Serv. Res. Pap. INT-2, 10 pp.

Describes four experiments designed to discover means of inducing strobilus formation in young seedlings and grafts of western white pine. Not one of the methods attempted was successful in markedly inducing or stimulating strobilus production.

BARNES, BURTON V., R. T. BINGHAM, and A. E. SQUILLACE. 1962. Selective fertilization in *Pinus monticola* Dougl. II. Results of additional tests. *Silvae Genetica* 11, Heft 4: 103-111, illus.

Tests were made to determine the extent of reproductive discrimination between competing self- and outcross-pollens of western white pine trees. Two seed trees were termed "completely self-fertile" and two trees were termed "partially self-fertile." However, most western white pine trees show a moderate to strong discrimination against self-pollen.

BINGHAM, R. T. 1956. Some preliminary results in testing seedling progenies from controlled pollinations among blister rust resistant western white pine. Third West. Int. Forest. Dis. Work Conf. Proc. 1955: 77-86.

Tests of  $F_1$  progenies from 47 rust-free western white pine selections showed that rust resistance was heritable. A small percentage of the selections transmitted a

high degree of foliar resistance to their  $F_1$  offspring, and about one-fourth to one-fifth of the selections were transmitting a useful degree of foliar resistance.

BINGHAM, R. T. 1959. Heritability and genetic improvement in log quality. Univ. Idaho Log Grading Conf. Proc., pp. 24-26.

A review of research results reveals the scarcity of concrete evidence as to genetic gain in characters affecting log quality. However, the small amount of evidence at hand indicates good likelihood for effecting genetic improvement of growth rate, stem form, branch angle, branch size, and spiral grain, all of which affect log quality.

BINGHAM, R. T. (Editor). 1960. An annotated directory to Canadian and foreign workers in forest genetics and related fields. *J. Forest.* 58: 602-618.

A cross-referenced directory giving names, addresses, and subject matter specialties of 744 Canadian and foreign workers in forest genetics.

BINGHAM, R. T. 1960. Progress in breeding blister rust resistant western white pine. Seventh West. Int. Forest Dis. Work Conf. Proc. 1959: 54-57.

Summarizes results to date of first generation breeding work and what these results mean in respect to production of resistant western white pine planting stock in the near future.

BINGHAM, R. T. 1961. The intra-species approach in breeding for disease resistance. Pp. 1691-1693. IN: *Recent Advances in Botany*, 1766 pp. Toronto: Univ. Toronto Press.

Suggests that with valuable local species the greatest early gains will come from intraspecies breeding. Breeding should be directed toward greater general adaptability in promising introduced species.

BINGHAM, R. T. 1963. New developments in breeding western white pine. I. Breeding for blister rust resistance. Forest Genetics Workshop Proc., South. Forest Tree Improvement Comm. Sponsored Pub. 22: 69-70.

Recent developments under the long-range program for breeding blister rust resistant western white pine are reported. Establishment of seed orchards to produce 50-percent resistant  $F_2$  seed by 1970 appears to be feasible.

BINGHAM, R. T. 1963. Problems and progress in improvement of rust resistance of North American trees. 12 pp. IN: World Consultation on Forest Genetics and Tree Improvement Proc. 2. Rome: FAO.

Studies and experiments directed toward production of strains of pines and poplars in North America resistant to Melampsora, Peridermium harknessii, Cronartium fusiforme, and C. ribicola indicate that no foreseeable obstacle (genetic variation within rust pathogens included) precludes attainment of highly resistant types.

BINGHAM, R. T., J. W. HANOVER, H. J. HARTMAN, and Q. W. LARSON. 1963. Western white pine experimental seed orchard established. J. Forest. 61: 300-301, illus.

Management practices for western white pine seed orchards are being analyzed on a 17-acre orchard established in 1960 on the Kaniksu National Forest at Sandpoint, Idaho. Information gained here will apply to the operation of 100 acres of grafted seed orchards proposed for production of relatively resistant western white pine stock.

BINGHAM, R. T., and A. E. SQUILLACE. 1955. Self-compatibility and effects of self-fertility in western white pine. Forest Sci. 1(2): 121-129, illus.

Cone and seed yields, germinability, and seedling height following self-pollination of 28 trees were compared against corresponding values for cross-pollination. Considerable tree-to-tree variation in self-compatibility and self-fertility was found. "Self-ability" or yield of self-pollinated seedlings relative to yield of cross-pollinated seedlings also varied considerably, averaging about 50 percent for the 28 trees studied. Seedling height during the first, second, and third years averaged 11, 21, and 21 percent, respectively, below heights of cross-pollinated seedlings.

BINGHAM, R. T., and A. E. SQUILLACE. 1957. Phenology and other features of the flowering of pines, with special reference to Pinus monticola Dougl. U.S. Forest Serv., Intermountain Forest and Range Exp. Sta. Res. Pap. 53, 26 pp., illus.

In western white pine the average date of first anthesis at high elevation was July 8, at low elevation June 27. Average period of pollen dissemination was  $8\frac{1}{2}$  days, ovulate flower receptivity,  $9\frac{1}{2}$  days. Flowering was delayed approximately 5 days per 1,000 feet increase in elevation, and 6 days per degree F. departure of May and June temperature below normal. Individual trees were found to be consistently early or late in time of onset of flowering, and the sequence of flowering between localities was firmly fixed.

BINGHAM, R. T., A. E. SQUILLACE, and J. W. DUFFIELD. 1953. Breeding blister-rust-resistant western white pine. J. Forest. 51: 163-168, illus.

Work on rust resistance in western white pine was started in the Inland Empire region in 1949. This article is a progress report covering work accomplished thus far and plans for future work.

BINGHAM, R. T., A. E. SQUILLACE, and R. F. PATTON. 1956. Vigor, disease resistance, and field performance in juvenile progenies of the hybrid Pinus monticola Dougl. X Pinus strobus L. Zeitschrift für Forstgenetik und Forstpflanzenzüchtung 5(4): 104-112, illus.

Juvenile performance of 16 different hybrid progenies from controlled pollinations between blister rust-resistant selections of eastern and western white pines is discussed in detail. Hybrids usually showed definite hybrid vigor and less resistance to rust than corresponding intraspecies crosses. The degree of hybrid vigor and rust resistance of a hybrid progeny seems to depend upon the superiority of the individual parents.

BINGHAM, R. T., A. E. SQUILLACE, and J. W. WRIGHT. 1960. Breeding blister rust resistant western white pine. II. First results of progeny tests including preliminary estimates of heritability and rate of improvement. Silvae Genetica 9, Heft 2:33-41, illus.

Describes and quantifies inheritance of blister rust resistance in controlled pollinated progenies of western white pine, extending the analyses to prediction of per-generation gain in resistance.

BINGHAM, R. T., A. E. SQUILLACE, and JONATHAN W. WRIGHT. 1961. Heritability of resistance in progenies from blister rust-resistant Pinus monticola selections. Pp. 1606-1612. IN: Recent Advances in Botany, 1766 pp. Toronto: Univ. Toronto Press.

Differences between types of mating and between individual single-cross progenies within resistant phenotype X resistant phenotype mating were highly significant. While average control progeny contained 5 percent survivors, the best wind-pollinated progeny of resistant phenotypes contained 19 percent survivors, and the best control-pollinated progeny of two resistant phenotypes contained 48 percent survivors, after

intense artificial inoculation of  $F_1$  seedlings in tests since 1952.

CALLAHAM, R. Z. 1960. Selecting the proper seed source of ponderosa pine. Soc. Amer. Forest. Proc. 1959: 26-27.

Supplies factual evidence to support long-standing recommendations on guides for selecting proper seed sources. For best performance, seed should be collected within an elevational zone of 1,000 feet above or below the planting site, within 50 miles, and from average or better trees.

CALLAHAM, ROBERT Z. 1960. Experimental taxonomy--more than seed source studies. Abstr. Ninth Int. Bot. Cong. Proc. 1959, II: 57.

Stresses need for new methods of experimental taxonomy to gain an understanding of physiology, biochemistry, genetics, and comparative cytology and morphology in foresters' investigations of variation. New approaches, such as used in ponderosa pine studies, can lead quickly and efficiently to resolving patterns of variation.

CALLAHAM, ROBERT Z. 1960. Temperature and seed germination for races of ponderosa pine. Abstr. Ninth Int. Bot. Cong. Proc. 1959, II: 57-58.

Rates of germination were determined at 8°, 16°, 24°, and 36° for half-sib progenies from 20 sources. Significant regional and local differences in germinative energy and germinative capacity were detected at most temperatures.

CALLAHAM, ROBERT Z. 1962. Geographic variability in growth of forest trees. Ch. 20, pp. 311-325. IN: Tree Growth, 442 pp., illus., edited by Theodore T. Kozłowski. New York: The Ronald Press.

Elaborates the theme that tree growth, like all other plant characters, results from interaction of genes and environment

and that the genes, environment, and interaction are not the same for every individual of a species.

DUFFIELD, J. W., and R. T. BINGHAM. 1963. Forest genetics and its application by the small woodland owners. Pp. 286-288. IN: Woodland Handbook for the Pacific Northwest, 422 pp. Fed. Coop. Ext. Serv., Oregon State Univ., Corvallis, Ore.

Provenance, heritability, plus tree seed orchard and fertilization studies point the way toward practical steps that the small woodland manager may take in improving seed used for reforestation. It suggests that the manager develop his own "local" seed supply, that he insist that genetic identity of his seed and nursery stock be maintained, and that he give consideration to genetics in his timber harvesting practices.

FOREST GENETICS STEERING COMMITTEE. 1952. A guide for the selection of superior trees in the northern Rocky Mountains. U.S. Forest Serv., Northern Rocky Mountain Forest and Range Exp. Sta. Misc. Pub. 6, 7 pp.

This report lists general specifications for superior trees, tells where to select them, shows distinguishing traits of individual species, and presents a program for discussing and reporting "plus" trees.

HANOVER, JAMES W. 1962. Clonal variation in western white pine. I. Graftability. U.S. Forest Serv., Inter-mountain Forest and Range Exp. Sta. Res. Note 101, 4 pp., illus.

Discusses some reasons for success or failure in graftability of different clones of western white pine.

HANOVER, JAMES W. 1963. Comparative biochemistry and physiology of western white pine (Pinus monticola Dougl.) resistant and susceptible to infection by the blister rust fungus (Cronartium

ribicola Fischer). Ph. D. Thesis, Washington State Univ., 176 pp.

More than 100 organic compounds were compared in resistant and susceptible trees. Possible differences were found in levels of glucose, total amino acids, and one phenolic. These leads will be followed in further studies.

HANOVER, JAMES W. 1963. Geographic variation in ponderosa pine leader growth. Forest Sci. 9: 86-95, illus.

Growth of the short apices of 91 trees in a 45-year-old ponderosa pine provenance test was measured periodically with a transit. The 19 races in the test showed phenological, morphological, or physiological variation in six characteristics: date of beginning growth in the spring, date of ending growth, total seasonal elongation, duration of growth, length of dormant terminal bud, and rapidity of growth.

HANOVER, JAMES W. 1963. New developments in breeding western white pine. II. Biochemistry of rust resistance. Forest Genetics Workshop Proc., South. Forest Tree Improvement Comm. Sponsored Pub. 22: 76-78.

Biochemical analyses for free sugars, amino acids, protein hydrolysates, organic acids, chlorophyll, B-carotene, and phosphorylated compounds, and analyses for dry matter, pH, and ash have failed to show associations with blister rust resistance. Preliminary information indicates association of a phenolic compound with resistance, but much additional study will be required to verify the association.

HANOVER, JAMES W. 1965. Effect of the chemical mugaten ethyl methane-sulfonate on western white pine. Silvae Genetica 14, Heft 1: 23-26.

Describes materials and methods used in experimental chemical treatment of seeds from eight progenies produced by

controlled pollination. Reports results of treatment and analyzes significance of variance in plant characteristics due to this treatment.

HANOVER, JAMES W., and BURTON V. BARNES. 1963. Heritability of height growth in year-old western white pine. Forest Genetics Workshop Proc., South. Forest Tree Improvement Comm. Sponsored Pub. 22: 71-76.

This paper reports results of an experiment in which total height and epicotyl length of 1-year-old seedlings of western white pine were used for computing heritability based on a modified diallel cross. The results clearly demonstrated presence of a relatively high male-female interaction in height growth compared with variation due to additive gene action.

KEMPF, GERHARD. 1928. Non-indigenous western yellow pine plantations in northern Idaho. Northwest Sci. 11(2): 54-58.

An unreplicated, 21-source ponderosa pine provenance test, with 100 trees per source, established 11 to 16 years previously at the Priest River Experimental Forest in northern Idaho (2,400 ft.) is described. Under a numerical index rating system considering each of four factors (survival, height growth, tree vigor, and frost resistance), five of the seven local sources, which were located on west slopes of the Northern Rocky Mountains, outperformed all others.

SMITH, EDWARD W., III, ELBERT CLEAVELAND, and DONALD W. LYNCH. 1956. A guide for finding superior ponderosa pine trees and stands in southwestern Idaho. South. Idaho Forest. Assoc., Inc., 8 pp+.

Defines for laymen certain genetics terms; gives instructions for selecting and reporting "plus" ponderosa pine trees.

SQUILLACE, A. E. 1952. Opportunities for forest genetics research in the northern Rocky Mountain region. Mont. Acad. Sci. Proc. 11: 3-7.

This paper describes experimental projects in forest genetics research that were active at the time of writing. Major current projects were: (1) a study of origins of ponderosa pine seed; (2) experimental breeding of blister rust resistant species of western white pine; (3) studies of special methods of propagation; and (4) testing of several pine hybrids. Proposes additional desirable projects for research.

SQUILLACE, A. E. 1957. Variations in cone properties, seed yield, and seed weight in western white pine when pollination is controlled. Mont. State Univ., School of Forest. Bull. 5, 16 pp., illus.

Seeds borne on shoots in the upper and outer crown and on the south and west sides of individual trees tended to be heavier than those in opposing portions of the crown. Cones borne on the more fruitful shoots tended to be longer and contained heavier seeds than those on the less fruitful shoots. Average weight of seeds in individual cones was found to be directly related to cone length and scale size and inversely related to seed yield. Longer cones usually yielded more seed but yield was also affected by pollen parent. An apparent effect of pollen parent upon the shape of cone scales was also found.



SQUILLACE, A. E., and R. T. BINGHAM.  
1954. Breeding for improved growth rate and timber quality in western white pine. *J. Forest.* 52: 656-661, illus.

Techniques and early results of intra-species breeding for faster growth rates and better quality in western white pine. Progeny seedlings produced through controlled pollinations among selected trees varied considerably in total height and significantly, though not strongly, reflected the growth rate of their respective parents. Average annual height growth during the last 10 years appeared better for studying heritability than average annual height growth during the whole life of the parent trees. A technique for measuring phenotypic traits in relatively open-grown, young western white pine trees was devised, which proved practical.

SQUILLACE, A. E., and R. T. BINGHAM.  
1954. Forest genetics research in the northern Rocky Mountain region. *J. Forest.* 52: 691-692.

Brief descriptions of forest genetics research projects in the northern Rocky Mountain region and some tentative recommendations for the conduct of future research.

SQUILLACE, A. E., and R. T. BINGHAM.  
1958. Localized ecotypic variation in western white pine. *Forest Sci.* 4(1): 20-34, illus.

Study of juvenile growth rates, apparent seed osmotic pressures, and foliage dry matter content of both controlled- and wind-pollinated seed and seedling progenies of Pinus monticola Dougl. trees growing on radically different sites indicated existence of ecotypes of very local nature.

SQUILLACE, A. E., and R. T. BINGHAM.  
1958. Selective fertilization in Pinus monticola Dougl. I. Preliminary results. *Silvae Genetica* 7, Heft 6: 188-196, illus.

Describes the preliminary results, based on 1-year-old progenies, from three tests to determine the selective fertilization effects of competing pollen in Pinus monticola Dougl.; makes recommendations for future study.

SQUILLACE, A. E., and ROY R. SILEN.  
1962. Racial variation in ponderosa pine. *Forest Sci. Monogr.* 2, 27 pp., illus.

Data from two ponderosa pine provenance studies conducted in northern Idaho and in Oregon and Washington were analyzed in detail. Results verify apparent differences in growth rate found earlier and correlate these differences with various geographic and climatic factors of the seed source localities.

WEIDMAN, R. H. 1925. Ten years' trial of some introduced species at Priest River Experiment Station. U.S. Forest Serv., Northern Rocky Mountain Forest and Range Exp. Sta. *Appl. Forest. Notes* 56, 3 pp.

European larch, Norway spruce, Norway (red) pine, Scotch pine, Austrian pine, and eastern white pine were planted on a dry site and on a comparatively moist site. From results after 10 years, only Norway spruce and Scotch pine appeared worthy of additional trials in northern Idaho.

WEIDMAN, R. H. 1939. Evidences of racial influence in a 25-year test of ponderosa pine. *J. Agr. Res.* 59(12): 855-888, illus.

A 25-year study of ponderosa pine growth from seed collected in 20 localities in the western United States showed that several characteristics (viz., number of needles per fascicle, length of needles, general appearance of foliage, and rate of growth) corresponded to differences among trees in the parent localities. It was concluded that these characteristics are strongly heritable in ponderosa pine and that a tree's growth rate and hardiness should be investigated (along with climatic characteristics of the locality where it grows) before seed is used for reforestation.

WRIGHT, JONATHAN W., R. T. BINGHAM, and K. W. DORMAN. 1958. Genetic variation within geographic ecotypes of forest trees and its role in tree improvement. *J. Forest.* 56: 803-808.

A review of published works on intra-specific and interracial variation in forest tree species and a discussion of the possibility for utilizing this variation in forest tree improvement.

#### FOREST SERVICE CREED

The Forest Service of the U.S. Department of Agriculture is dedicated to the principle of multiple use management of the Nation's Forest Resources for sustained yields of wood, water, forage, wildlife, and recreation. Through forestry research, cooperation with the States and private owners, and management of the National Forests and National Grasslands, it strives — as directed by Congress — to provide increasingly greater service to a growing Nation.



# Research Note

UNITED STATES DEPARTMENT OF AGRICULTURE  
FOREST SERVICE

INTERMOUNTAIN FOREST & RANGE EXPERIMENT STATION  
OGDEN UTAH

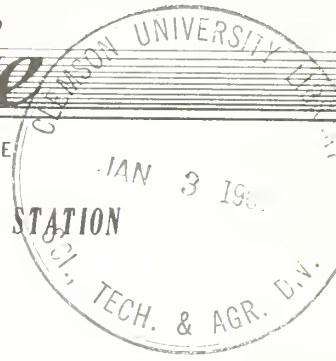

U.S. Forest Service  
Research Note INT-49

1966

## A PROCEDURE FOR FORECASTING WESTERN LARCH SEED CROPS

Arthur L. Roe  
Principal Silviculturist

### ABSTRACT

Successful regeneration depends upon good coordination between seed production and seedbed preparation. To aid forest managers in scheduling seedbed preparation, a simple sequential sampling plan for estimating potential cone crops as much as a year in advance of the seed fall was developed and is described herein. With advance knowledge of the cone crop prospects, the manager can schedule seedbed preparation or select an alternative action such as postponing work or substituting planting.

The potential of a western larch seed crop can be estimated as much as a year in advance of seed fall by sampling ovulate buds. When the winter buds are set at the end of the growing season, the staminate, ovulate, and vegetative buds are fully differentiated and recognizable. Ovulate buds then may be identified by their shape and size, a fact that provides a practical basis for estimating the possibility of a forthcoming seed crop.

Seed crop potential may also be evaluated in early spring by counting the new strobili or conelets with the aid of binoculars. The spring strobili are counted much later than ovulate buds. Consequently, the time before seed ripening and dissemination is much shorter than it is when bud counts are taken.

The forest manager who depends upon natural regeneration to restock cutover areas can coordinate seedbed preparation with seed production more effectively if he has some early knowledge of the prospective seed crop. If prospects of seed production are very poor he may decide to use artificial regeneration; if seed prospects are good, he may prepare as much seedbed as possible. To aid the forest manager in making this decision, a simple procedure to determine the prospects of the seed crop has been devised.

## SAMPLING PROCEDURE

### SAMPLING OVULATE BUDS

Bud description. -- Western larch buds commonly are borne on the end of dwarfed, short, spurlike lateral branchlets. The vegetative buds are small--usually between 1/10- to 1/8-inch diameter. Flower buds, from 1/8- to 3/16-inch diameter, are as long or longer than wide. The staminate buds are usually globose or subglobose, about as long as they are wide, and ovulate buds are usually longer ( $1\frac{1}{2}$  to 2 times) than their width and are either rounded or conical on the end (figs. 1A, 1B). The ovulate buds can be identified with ease, thereby making sampling simple. When the buds cannot be identified visually, they can be cut to expose a longitudinal section and positively be identified (fig. 2).

Collecting the sample. -- Seed trees are sampled by randomly collecting a minimum of four and up to 12 major branches in the larch crown. Select only dominant or codominant full-crowned trees growing in forest stands--not open grown. Do not include internodal branches. A major branch is defined as one that originates at a node and is free to grow to the full average crown width where it is located in the crown. Collect branches preferably in the upper two-thirds of the crown. Obtain sample branches by (1) climbing the trees, (2) examining trees felled in logging, or (3) shooting them off with a rifle. Count the number of ovulate buds for each branch.

### SAMPLING STROBILI WITH THE AID OF BINOCULARS

Conelet description. -- The strobili (new conelets) appear after the tree has begun growth in the spring--usually about April 15 to May 15. They precede the foliage by several days. The color of the strobili varies from green and green-brown to a distinctive red color. Strobili grow very rapidly and soon reach the size of the old cones that have adhered from previous years. The old cones are distinguishable from the new strobili by color because size distinction is not reliable.

Counting conelet samples. -- The sampling procedure is much the same as that for counting buds. The observer, using binoculars, randomly selects a minimum of four major branches. He scans each one and counts the strobili, avoiding counting persistent cones from the previous years. Because size is not reliable in separating the new conelets and old cones, the observer should move about until the light reflects the color of the conelet to him. Strobili are most easily seen from the ground with the aid of 6X or 7X binoculars. After the foliage grows out, the presence of the strobili is obscured.

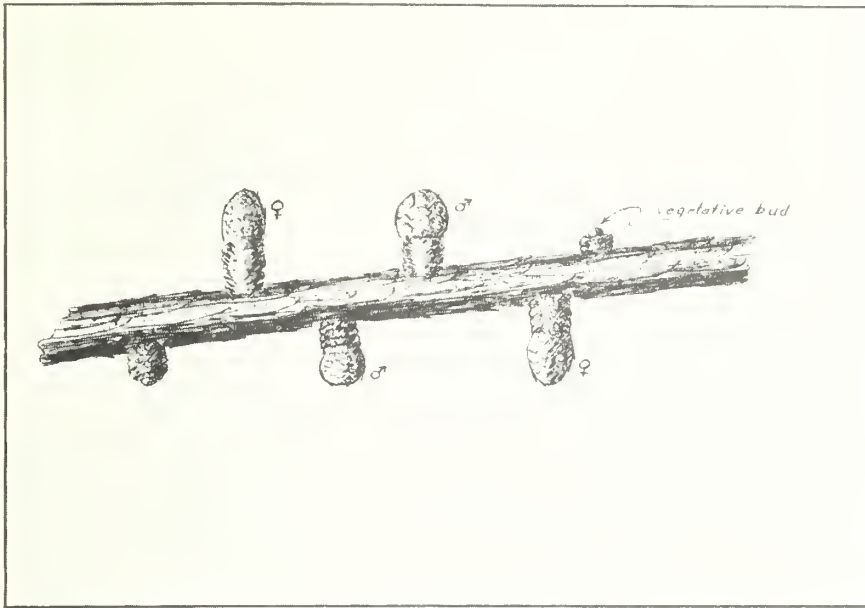

A

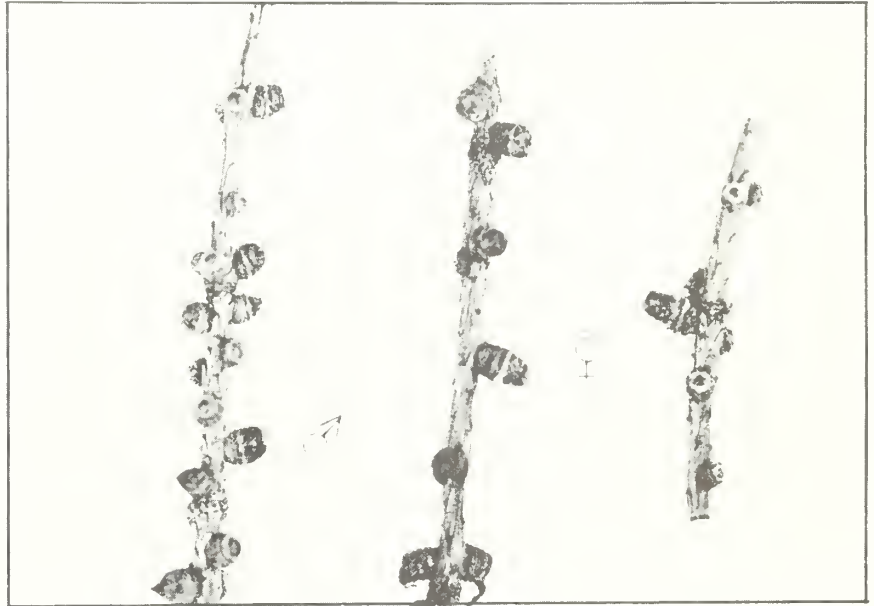

B

Figure 1.--A, Sketch of typical winter buds of western larch showing ovulate, staminate, and vegetative buds. B, The twig on the left shows only staminate and vegetative buds, while the other two twigs illustrate all types of buds.

Figure 2.--The longitudinal section of ovulate and staminate buds.

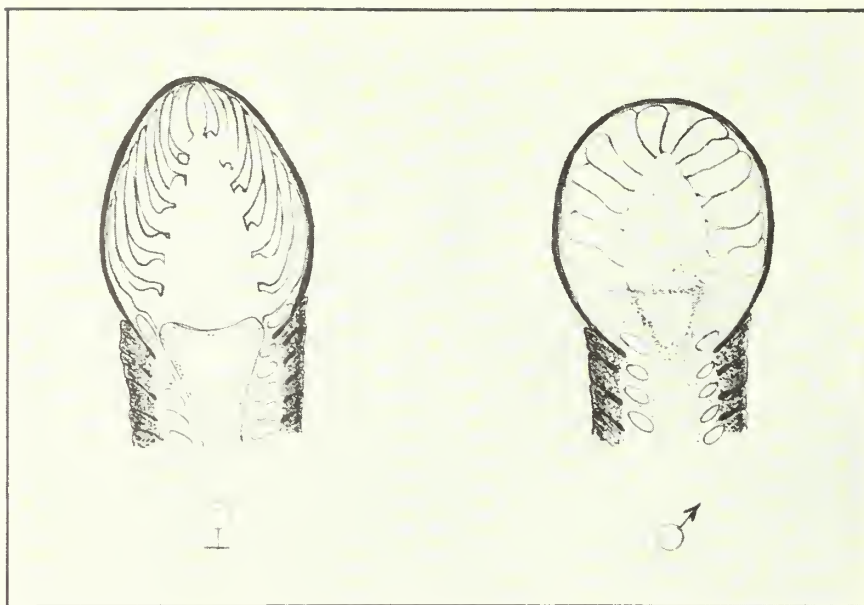

### CLASSIFYING PROSPECTIVE CONE PRODUCTION

To determine relative production, the counts of ovulate buds or strobili per major branch must be related to some standard. Therefore, a sequential sampling plan<sup>1</sup> was evolved using the counts of strobili obtained during the good seed year of 1954. This plan furnishes an objective technique for rating and forecasting prospects of the developing seed crops.

The coefficient of variation was determined for the sample trees in each sample counted in 1954. A curve was fitted to the relationship of the coefficient of variation and the mean number of strobili per branch. This curve provided estimates of the coefficient of variation for both low and high cone production from which the estimated standard deviations used in the sampling plan were obtained. For the sampling plan, 10 strobili per branch were chosen arbitrarily as the lower limit of a good seed crop, and three strobili per branch were designated as the lower limit for a medium crop. The probability of making a wrong decision based upon the sampling was set at 10 percent in the plan. Values computed for the sequential sampling plan are shown in figure 3, a suggested tally form.

To use the sequential sampling plan, estimate seed production for individual trees as follows: Record the branch counts (ovulate buds or strobili) in column 2 of the tally form as they are collected. Adjust the count for anticipated loss by reducing the count 50 percent and add the adjusted value to the cumulative total ( $\Sigma x$ ) column 4 or 7. At each entry compare the cumulative total against the critical values on either side of columns 4 and 7.

<sup>1</sup> For a discussion of computing sequential analysis charts, etc., see chap. 18, pp. 304-317, Dixon and Massey, "Introduction to Statistical Analysis," 2d ed. New York: McGraw-Hill Book Company. 1957.

(1)	(2)	(3)	(4)	(5)	(6)	(7)	(8)
Branch no.	Branch tally (x)	Good	vs. $\Sigma x$	Medium	Medium	vs. $\Sigma x$	Poor
1	8	20				4	
2	4	29				6	
3	8	38				10	2
4	7	47		25	26	13.5	6
5	0	56		34	30	13.5	10
6	2	65		43	34	14.5	14
7	6	74		52	38	17.5	18
8		83		67	42		22
9		92		70	46		26
10		101		79	50		30
11		110		88	54		34
12		119		97	58		38

Figure 3.--A suggested tally form for sequential sampling of prospective western larch seed crops in western larch trees.

After each comparison decide whether the crop can be classified or sampling should be continued. If the cumulative total exceeds the column 3 value on that line, sampling stops and the crop in prospect is rated as good; if the total falls below column 5 and above column 6 values, sampling also stops and the prospective crop is rated medium; finally, if the cumulative total falls below column 8 values, cease sampling and rate the prospective crop as poor. If none of the above conditions are met, continue to sample by counting another branch sample and adding it to the tally. If no decision has been reached after 12 sample counts have been accumulated, stop sampling and classify the prospective crop in the nearest category approached by the cumulative count.

The crop of the tree used as an example in the tally sheet in figure 3 was rated as poor after the counts from seven branches were tallied. The total 17.5, attained after the seventh branch count was accumulated, fell below the critical value 18 in column 8, line 7. In some instances a decision may be made after one or two branches have been sampled, but a minimum sample of four branches per tree selected, one from each quarter of the tree crown length, is recommended.

Tree no.	Tree tally (x)	Good	vs.		Medium	Medium	vs.		Poor
				$\Sigma x$				$\Sigma x$	
1	7	12	7		6	6			2
2	8	21	15		15	11			6
3	10	30	25		24	14			10
4	8	39	33		33	18			14
5	43	48	76		42	22			18
6		57			51	26			22
7		66			60	30			26
8		75			69	34			30
9		84			78	38			34
10		93			87	42			38
11		102			96	46			42
12		111			105	50			44

Figure 4.--A suggested tally form for sequential sampling of prospective seed crops in western larch stands.

Using the same procedure, the seed crop from a stand can also be estimated. The estimated average buds or cones per branch on each tree classified in the stand are entered on the form shown in figure 4. The limits on this form apply to the means of sample trees. Thus the mean number of cones per branch of each tree as it is determined by sampling within the tree crown is recorded on the form illustrated in figure 4. The stand classification--good, medium, or poor--is determined in the same manner for stands as for individual trees.

### DISCUSSION

The sampling basis for estimating standard deviation used in computing the critical values in this study is small. Because additional data are highly desirable, samples should be collected each year. As additional data are accumulated, better estimates of the standard deviation and other characteristics can be made. It is important to span the years as well as areas, so there is no advantage in trying to collect a large sample in any one year.



The technique described above provides only an estimate of the prospective seed crop. A large sample of buds or early strobili does not necessarily mean that a large seed crop will materialize. Unseasonable frost or seed and cone insects are among the many agents that may cause seed loss between flower initiation and cone maturity and, thereby, reduce or eliminate the seed crop. Further studies are required to increase our understanding and knowledge of these factors. A better basis for forecasting seed years will then be provided.

This technique should aid forest managers in collecting data on seed year prospects as a basis for planning seedbed preparation. Although the possibility of crop failure from unpredictable factors may be considerable in cases of good and medium prospects, there should be a high degree of success in forecasting poor or fail crops. When seedbed preparation is carried out in the face of very poor or fail seed crops, the probabilities of regeneration failure are high. Knowing the prospect of poor or fail seed crops several months before seed fall, the manager can alter plans by postponing the work or substituting planting.

#### FOREST SERVICE CREED

The Forest Service of the U. S. Department of Agriculture is dedicated to the principle of multiple use management of the Nation's forest resources for sustained yields of wood, water, forage, wildlife, and recreation. Through forestry research, cooperation with the States and private forest owners, and management of the National Forests and National Grasslands, it strives — as directed by Congress — to provide increasingly greater service to a growing nation.





# Research Note

UNITED STATES DEPARTMENT OF AGRICULTURE  
FOREST SERVICE

INTERMOUNTAIN FOREST & RANGE EXPERIMENT STATION  
OGDEN UTAH



U.S. Forest Service  
Research Note INT-50

1966

## GROWTH OPPORTUNITIES FOR YOUNG WESTERN LARCH

Wyman C. Schmidt<sup>1</sup>

### ABSTRACT

Young western larch stands commonly overstock and have as many as 30,000 to 40,000 trees per acre. A typical 9-year-old larch stand showed that individual tree growth and crown development were far better where stocking rates were not this heavy. Dominant larch grew twice as much in diameter and one-third more in height on plots having 5,000 trees per acre as they did on plots with 35,000 trees per acre. Very early thinning is recommended for heavily overstocked larch stands.

Western larch characteristically overstocks. Young stands of this highly intolerant species commonly reach stocking rates of 30,000 to 40,000 stems per acre and stocking of 100,000 trees per acre has been recorded. Obviously, where stocking is this heavy, trees compete vigorously for the available water, nutrients, and light. Such competition seriously reduces individual tree growth and development.

Programs of stand improvement must aim at preventing early limitations of growth resulting from overstocking. Past studies show serious consequences in larch stands that were not thinned or where thinning was delayed too long (Roe and Schmidt 1965). For example, dominant trees in a stand stocked with about 5,000 trees per acre at age 30 grew at only one-third of their potential rate from age 30 to 57. Thinning a similar adjacent stand at age 30 increased both diameter and height growth, but growth lost before thinning was substantial and was not regained during the 27-year period after thinning. Trees responded slowly after thinning because 30 years of overstocking had reduced the general vigor and crown size of the trees.

<sup>1</sup>Associate Silviculturist, Intermountain Forest and Range Experiment Station, headquartered at Missoula, Montana. This paper was presented at the 1966 meeting of the Northwest Scientific Association.

Thus, overstocked larch stands must be thinned very early to prevent loss of growth and vigor. However, forest managers ask the question: how early in the life of the stand does overstocking begin restricting growth of individual crop trees? The study reported here helps answer that question. It describes the stand density-growth relations in a typical 9-year-old larch stand. Briefly, it shows that even at this early age individual trees grow far better where stocking is lighter and demonstrates the urgency of thinning very early in heavily overstocked larch stands.

#### DESCRIPTION OF STUDY AREA AND METHODS

The study area was located on the Coram Experimental Forest in northwestern Montana at an elevation of about 3,800 feet. Slope, aspect, soil, and ecological habitat type were relatively uniform throughout the area. All study plots were situated on gently sloping, north-facing aspects. The soil, a brown podzolic, was classified in the Waits series. The entire area can be classified as a Picea-Abies/Pachistima ecological habitat type (Daubenmire 1952). Site productivity was medium for larch; site index 58 feet at 50 years (Cummings 1937). The stand throughout the study area regenerated naturally from the heavy larch seed crop of 1952 following clearcutting and prescribed burning. At the time these plots were measured, the stand was 9 years old (fig. 1).

Individual tree measurements included diameters at breast height, total heights, and crown lengths of the 20 tallest larch in each of twenty-six 1/10-acre plots. Stand densities, determined for each 1/10-acre plot by a sample of ten 1-milacre quadrats, ranged from 5,000 to 37,000 trees per acre; larch accounted for 88 percent of the stocking.

Regression analyses were used for plotting the stand density-growth curves.



Figure 1. --Typical 9-year-old larch stand on the study area. This stand is stocked with 23,000 trees per acre--far too many for optimum growth and development.

## RESULTS

Dominant larch grew fastest in diameter and height and retained fullest crowns in stands having the fewest trees during the first 9 years of their lives (fig. 2). Stand density and individual tree development of the 200 largest trees per acre were related as follows:

1. Diameter growth showed the greatest effect of overstocking. Average diameters ranged from about 0.3 inch on plots having 35,000 trees per acre up to about 0.6 inch on those having 5,000 trees--a 100-percent difference in diameter.
2. Height growth showed the same effect as diameter, but the differences were not as great. Heights of the dominant trees averaged 6 feet on plots that had 35,000 trees per acre and 8 feet where there were only 5,000 trees per acre--a 33-percent difference in height.
3. Crown length, as a percent of total height, showed the same relation to stand density as diameter and height; crowns were longest on the least dense plots. Longer crowns were readily apparent on the less dense plots even though the absolute differences in crown length were not great. Average crown lengths ranged from 87 percent of total height on heavily stocked plots up to 97 percent on the lightly stocked plots--a 10-percent difference in crown length.

## EFFECTS OF STAND DENSITY ON 9-YEAR OLD LARCH

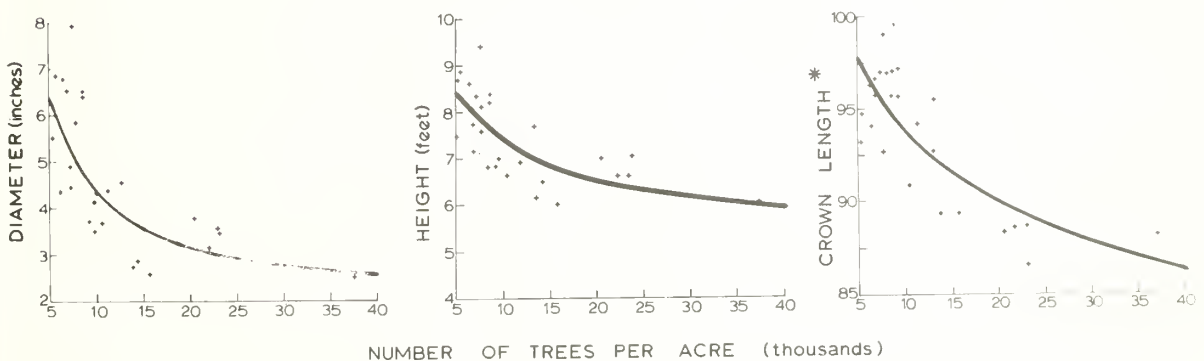

\* Percent of total height

Figure 2. --Effects of density on 9-year-old larch stands.

## DISCUSSION

Western larch grows faster and retains a fuller crown where stocking rates are lighter, even in stands as young as 9 years old. Measured differences in growth of the dominant trees up to this age are not great, but percentage differences are substantial. For example, if the present diameter growth ratios in these stands are maintained, crop trees in the less densely stocked areas will average 10 inches about the same time those in the most densely stocked stands average 5 inches. All evidence indicates that these differences in growth rate will continue and will likely become progressively greater as the stands grow older.

Crown losses on these young trees demonstrate the extreme shade intolerance of larch and are symptomatic of overstocking. Some natural pruning of larch is desirable, but excessive crown losses from pruning can reduce the general vigor and growth of the stand.

The growth and stand density relations shown in this study emphasize the management opportunities available in young larch stands and demonstrate that even at this early age these stands are not immune to the effects of overstocking. Growth potential for larch apparently far exceeds its normal growth in natural unmanaged stands. The shape of the curves (fig. 2) demonstrates the wide difference in individual tree growth and implies that dominant trees would have grown much faster in stands having fewer than 5,000 trees per acre--the lowest density represented in this study.

By thinning early, even before the trees are 9 years old, forest managers can take full advantage of the rapid juvenile growth characteristic of larch. Early thinning allows selected trees to adjust easily to added growing space and to maintain good growth. Delay in thinning permits growth losses to accumulate rapidly, allows the trees to degenerate in vigor, and consequently impedes their ability to respond to increased growing space after thinning.

## LITERATURE CITED

- Cummings, L. J.  
1937. Larch--Douglas-fir board-foot yield tables. U.S. Forest Serv., Northern Rocky Mountain Forest and Range Exp. Sta. Applied Forest. Note 78, 3 pp.
- Daubenmire, R.  
1952. Forest vegetation of northern Idaho and adjacent Washington, and its bearing on concepts of vegetation classification. Ecol. Monogr. 22: 301-330.
- Roe, Arthur L., and Wyman C. Schmidt.  
1965. Thinning western larch. U.S. Forest Serv. Res. Pap. INT-16, 10 pp.













