

I 29.88:W 84

Clemson University



3 1604 019 700 956

historic structure report
historical data section

PUBLIC DOCUMENTS
DEPOSITORY ITEM

MAY 26 1987

CLEMSON
LIBRARY

WESLEYAN CHAPEL
WOMEN'S RIGHTS



NATIONAL HISTORICAL PARK / NEW YORK





Digitized by the Internet Archive
in 2012 with funding from
LYRASIS Members and Sloan Foundation

<http://archive.org/details/historicstructur00women>

HISTORIC STRUCTURE REPORT

Historical Data Section

Wesleyan Chapel

Women's Rights National Historical Park
New York

by
Sharon A. Brown

April 1987

DEDICATION

The author wishes to dedicate this historic structure report on the Wesleyan Chapel to the memory of Dr. Corinne Guntzel.

Her friendship is greatly missed.



TABLE OF CONTENTS

DEDICATION	iii
LIST OF ILLUSTRATIONS	vii
PREFACE	ix
INTRODUCTION	xi
CHRONOLOGY	xiii
CHAPTER I. HISTORY OF WESLEYAN METHODIST OCCUPANCY	1
Building the Chapel	2
The Wesleyan Congregation 1843-1869	6
Raising Money	9
Parsonage	10
Wesleyan vs Congregationalist Controversy 1869	12
The Chapel Exterior	30
The Chapel Interior	36
Chapel Repairs	40
Selling Portion of Chapel Lot	42
Activities in the Chapel	43
CHAPTER II. 1848 WOMEN'S RIGHTS CONVENTION	49
Seneca Falls in 1848	49
The Convention Organizers' Previous Reform Efforts	54
Elizabeth Cady Stanton's "General Discontent"	57
The Convention Proceedings	59
Reaction to the Convention	66
CHAPTER III. EVOLUTION OF THE WESLEYAN CHAPEL	73
William Johnson's Hall	73
Johnson Hall Appearance and Repairs	76
Johnson Hall Tenants	78
Johnson Opera House	80
1908 Observance of 1848 Women's Rights Convention	84
1915 Observance of Elizabeth Cady Stanton Birthday	85
Johnson Opera House Appearance and Repairs	86
Selling Portion of Opera House Lot	91
Powers' Furniture Store and Doyle's Picture House	92
Regent Theatre	94
Seneca Falls Garage, Inc.	99
Huntington Ford and the 1923 Women's Rights Convention Anniversary	102
Seneca Falls Sales Co., Inc.	106
Centennial Observance of 1848 Women's Rights Convention	109
Seneca Falls Laundromat	111
RECOMMENDATIONS FOR FURTHER RESEARCH	113

APPENDICES	117	
APPENDIX A: DETAILS OF WESLEYAN CHAPEL INTERIOR	119	
APPENDIX B: APPEARANCE OF WESLEYAN CHAPEL, JULY 1848		127
APPENDIX C: CHRONOLOGY OF EVENTS HELD IN WESLEYAN CHAPEL	128	
APPENDIX D: BIOGRAPHIES OF FIVE WOMEN WHO ORGANIZED THE 1848 WOMEN'S RIGHTS CONVENTION HELD IN WESLEYAN CHAPEL		132
APPENDIX E: JOHNSON HALL AND OPERA HOUSE EVENTS	138	
PERSONS CONSULTED DURING RESEARCH	147	
REPOSITORIES VISITED DURING RESEARCH	148	
REPOSITORIES CONSULTED DURING RESEARCH	149	
REPOSITORIES VISITED BY ELAINE BROWN	151	
ILLUSTRATIONS	153	
ANNOTATED BIBLIOGRAPHY	291	

LIST OF ILLUSTRATIONS

CHAPTER I

1. 1836 Seneca Falls Map
2. 1836 Seneca Falls Map, Detail
3. Luther Lee
4. Samuel Salisbury
5. William W. Lyle
6. View of probable Wesleyan Chapel behind the Arnett Mill
7. Interior of Old Wesleyan Church with Pastor, Superintendent & Teachers of Sabbath School
8. 1856 Seneca Falls Map
9. 1856 Seneca Falls Map, Detail
10. 1871 Seneca Falls Map
11. 1871 Seneca Falls Map, Detail

CHAPTER II

12. The five women who organized the 1848 Women's Rights Convention

CHAPTER III

13. 1873 Seneca Falls Map
14. 1873 Seneca Falls Map, Detail
15. 1882 Seneca Falls Map
16. 1882 Seneca Falls Map, Detail
17. William Johnson
18. Residence of Senator William Johnson
19. "Grand Rally at Johnson Hall, To-Night," Handbill
20. "Pepita! The Gipsy Girl of Andalusia!" Handbill
21. "Grand Concert," Handbill
22. "Prohibition Meeting," Handbill
23. 1881 Sanborn Map, Detail
24. 1886 Sanborn Map, Detail
25. Charles Chamberlain Johnson
26. Great Fire July 30, 1890
27. Corner of Fall and State Sts. (July 1890)
28. Corner of Fall and Mynderse Sts.
29. Johnson Opera House
30. Corner of Fall & Mynderse Streets
31. "Bon-Ton Minstrels," Handbill
32. "The Klondike Johnson Opera House Tattler," Handbill
33. "Johnson Opera House Programme The Legend of Don Munio," Handbill
34. "Select Masque Ball," Handbill
35. "Temple of Fame," Handbill
36. "David Garrick," Handbill
37. "Our New Minister," Handbill

38. 60th Anniversary of 1848 Convention
39. 1896 Seneca Falls Map
40. 1896 Seneca Falls Map, Detail
41. 1897 Sanborn Map, Detail
42. 1911 Sanborn Map, Detail
43. Possible Johnson Opera House Interior
44. Johnson Opera House Interior
45. Powers' Furniture Advertisement, 1907
46. Powers' Furniture Advertisement, 1908
47. Fall Street Seneca Falls, N.Y. looking east from Johnson Opera House
48. Fisher Theatre (Powers' Furniture located next door)
49. Powers' Furniture Advertisement, 1916
50. Theatre District, Seneca Falls, N.Y.
51. Regent Theatre, Seneca Falls, N.Y.
52. "Monster Bazaar and Entertainment at the new Regent Theatre," Advertisement, 1917
53. "Grand Opening of the Regent Theatre," Advertisement, 1917
54. Regent Theatre Advertisement, 1918
55. Mynderse and Fall Streets (Seneca Falls Garage, Inc.)
56. Seneca Falls Garage, Inc., Advertisement, 1920
57. Seneca Falls Garage, Inc., Advertisement, 1920
58. Fred L. Huntington Ford, Advertisement, 1922
59. Group of people displaying commemorative tablet, 1923
60. 1925 Sanborn Map, Detail
61. Members of N.Y.S. League of Women Voters attending replacing of tablet at Seneca Falls, 1928
62. Seneca Falls Sales Co., Inc., Advertisement, 1929
63. Ford Garage
64. Ford Garage Detail
65. Lynch plat map of building, 1944
66. 1925 Sanborn Map corrected to 1955, Detail
67. Seneca Falls Sales Co., Inc. Advertisement, 1948
68. Seneca Falls Laundromat Advertisement, 1961
69. Seneca Falls Laundromat Advertisement, 1964
70. Seneca Falls Laundromat after purchase by National Park Service

PREFACE

The Methodist Wesleyan Chapel was built in 1843 as a haven of religious freedom and free speech. Exponents of various reforms then sweeping upstate New York and the nation found an open pulpit in the chapel, from which they could voice their views. Abolition and temperance issues were not the only topics discussed; in July 1848 the chapel hosted the very first women's rights convention held in America.

A local resident, Elizabeth Cady Stanton, was the driving force behind the convention. Several friends from Philadelphia, and Waterloo and Seneca Falls, New York, aided in the organization and writing of convention documents. From this early effort, wherein the call for women's suffrage was first issued, the women's rights movement treaded the waters of reform.

After the Wesleyan Methodists moved out of the chapel by February 1872, the building was sold many times and converted into a larger building with several different uses. Repeated renovations and alterations have considerably changed, and in some physical aspects, obliterated traces of the original Wesleyan Chapel. Data on many of these changes is either scant or very general, resulting in the building's physical history being difficult to trace for both the historian and the historical architect. Nevertheless, much of the building's history of occupation can be traced and is documented in this study.

Ironically, by the time the National Park Service acquired the former chapel it had been turned into a self-help laundromat, which has been interpreted by many as a political statement in itself about the current status of the women's rights movement in America. Regardless of the twists and turns of its physical evolution, the Wesleyan Chapel remnants still stand as the most visible symbol of the nineteenth and twentieth century reform movement to change attitudes concerning women's status in American life. The chapel's remaining historical fabric should be

protected, as its survival in the face of extensive change is a little less than remarkable.

Historical data on the Wesleyan Chapel's appearance in July 1848, at the time of the convention, is extremely scarce. What little information found in the Wesleyan Methodist congregational record books about the chapel interior or exterior generally pertains to a latter time period. Elizabeth Cady Stanton's reminiscences provide only very limited data, and only one other convention attendee's brief description has been located. Efforts to find a physical description of the chapel in local newspapers was fruitless, as was the search for a photograph of the chapel at any time during its occupancy by the Wesleyan Methodists. It is unlikely a photograph of the chapel in 1848 exists, as this date corresponds with the formative years of photography. Therefore, reconstruction of the chapel to its 1848 appearance cannot be undertaken. No effort should be made to replicate or duplicate missing interior or exterior building fabric, as such action would be incompatible with National Park Service cultural resources policy.

INTRODUCTION

Women's Rights National Historical Park was authorized for inclusion in the National Park System on December 28, 1980. The park is located in Seneca Falls and Waterloo, New York. Five sites associated with the nineteenth century women's rights movement and the 1848 Women's Rights Convention were mentioned in the legislation--the Wesleyan Chapel and the Stanton, McClintock, Hunt and Bloomer houses in Seneca Falls and Waterloo. The historical park was dedicated in July 1982 and is currently open for limited public use.

Data from this report will be used to plan the interpretation and preservation of the Wesleyan Chapel remnants. Emphasis in research and writing was placed on specific construction data and occupancy history relating to the chapel.

Most of the historical research was conducted at the Seneca Falls Historical Society and various other area archives and repositories. Research trips to Seneca Falls, Waterloo and Ithaca, New York, in autumn and winter 1985-1986 uncovered construction and occupant use data. A side trip to Washington, D.C., in August 1985 allowed research at the Library of Congress.

Another aspect of the research involved locating photographs or drawings of the Wesleyan Chapel during the years of Methodist Wesleyan ownership. Much of this work involved contacting many local and regional repositories. Local historians and librarians made long searches for any type of photographic rendering of the chapel. Inquiries were sent to photographic collection agencies, as well as to repositories possessing papers of Elizabeth Cady Stanton's children, and professional history journals. Much of the search for a Wesleyan Chapel photograph was conducted by the Stanton Foundation in Seneca Falls, then under the leadership of Dr. Corinne Guntzel.

Many people deserve thanks for their help and advice during the course of the research for this report. Superintendent Judy Hart and her staff at Women's Rights National Historical Park, especially Margaret McFadden, gave endless time, advice and support. The ex-director of the Seneca Falls Historical Society, Gerilyn Heisser, and her staff offered the author free rein in digging through photographs and archive collections. Ms. Heisser also graciously arranged for microfilm of Seneca Falls newspapers to be periodically sent on temporary loan to Denver. Ruth Larison of the Rocky Mountain Region library in Denver obtained much secondary source material through interlibrary loan. Special consideration goes to Elaine Brown for her efforts in providing research leads and in searching for a photograph of the Wesleyan Chapel. Lee M. Haines, Reverend Paul W. Thomas and Luella Hanna of The Wesleyan Church, Archives and Historical Library in Marion, Indiana, aided with the search for details of the chapel construction and congregational history. Dr. Judith Wellman graciously shared her research on the Declaration of Sentiments signers. Jim Askins, Harry Sloat, Fran Lucas, Bruce Martin and Keith Newlin from the Williamsport Training Center uncovered the chapel remnants, while archeologists Dana Linck, Paula Zitzler and crew found the chapel's footprint. At the Denver Service Center, Nan Rickey, John Albright, Bonnie Campbell and Linda Romola offered counsel, and Joan Manson typed the report.

Sharon A. Brown
April 1986

CHRONOLOGY

1843--Wesleyan Chapel built and dedicated by First Wesleyan Methodist Society of Seneca Falls, New York

July 1848--Women's Rights Convention

October 1871--Trustees of the First Wesleyan Methodist Society of Seneca Falls sell chapel to Charles G. Corwin

July 1872--Charles and Helena Corwin sell chapel to William Johnson

June-August 1872--Chapel converted into two stores and a hall

known tenants--co-operative grocery; Boyd furniture store

known tenants in 1881--vacant

known tenants in 1886--"H&L Ho," "Hose Ho." and plumber

August-September 1890--Hall converted into opera house

September 1891--Angeline and Charles Chamberlain Johnson, widow and son of William Johnson, sell 25-foot strip of land in rear of opera house to E.J. Ryan Sr.

known tenants in 1897--bowling, repair shop, plumber

May 1908--60th anniversary of 1848 Women's Rights Convention; bronze commemorative tablet placed on east wall of opera house

known tenants--Doyle's Picture House; Powers' furniture store

December 1915--Charles Chamberlain and Frances Johnson sell opera house to Charles H. Powers

September 1917--Charles H. and Minnie Powers sell building to Asa B. Hilbert

December 1917--Opening of Regent Theatre in building

known tenants--New York Telephone Company; Dr. Albert Frantz

October 1919--Asa B. Hilbert sells building to Bertrand G. Mackey and Frank G. Knox

known tenants--New York Telephone Company; Dr. Albert Frantz; G.L. Ayers store

January 1920--Opening of Seneca Falls Garage, Inc.

known tenants--Dr. Albert Frantz; New York Telephone Company; Frank H. Smith; Seneca Falls Athletic Association; Kibbey Repair Shop; lyceum hall

1921--Hilbert suit against Mackey and Knox, case went to supreme court, building put up for sale at public auction

May 1921--Asa B. Hilbert repurchased building at public auction

known tenants--Dr. Albert Frantz; New York Telephone Company; Fred L. Huntington Ford and Pontiac dealership

July 1923--75th anniversary of 1848 Women's Rights Convention

July 1925--Asa B. and Louise Hilbert sell building to Geneva Farm Improvement Corporation

February 1926--Geneva Farm Improvement Corporation sells building to Cornelius T. Lynch

known tenants in 1927--New York Telephone; Dr. Albert Frantz; E.W. Hudson and Son

known tenants in 1929--New York Telephone; Dr. Albert Frantz; Seneca Falls Sales Company, Inc. (Ford dealership)

known tenant in 1935--Seneca Falls Sales Company, Inc.

November 1944--Cornelius T. and Elizabeth Lynch sell building to Henderson & Lathrop

July 1948--Centennial observance of 1848 Women's Rights Convention

September 28, 1956--Henderson & Lathrop, Inc. sell building to Edwin A. Riggs Jr.

known tenant in 1956--Seneca Falls Sales Company, Inc.

known tenant in 1958--East Motors

December 1959--Edwin A. Riggs Jr. sold building to Henderson & Lathrop, Inc.

known tenant in 1961--Seneca Falls Laundromat

February 1971--Henderson & Lathrop, Inc. sell building to Frank J. Ludovico

April 1985--Frank J. Ludovico sold building to National Park Service



CHAPTER I: HISTORY OF WESLEYAN METHODIST OCCUPANCY

On February 13, 1843, Seneca Falls resident Joseph Metcalf wrote a letter to the True Wesleyan newspaper. He announced that 26 people had met on the 11th to organize themselves into a Wesleyan Methodist church. Several more people had since joined, and Metcalf had no doubts the new congregation's membership would reach about 100. Many more were waiting to join when "we can get a man to bestow pastoral labor upon us." Metcalf and his friends had left their present place of worship, the Methodist Episcopal Church, and wished to "begin the world anew - at the same time wishing nothing but blessings upon those we leave." The group immediately began negotiating for a lot, upon which to build a "house of worship" in the spring.¹

These dissident Methodists formally organized the First Wesleyan Methodist Society of Seneca Falls on the evening of March 27, 1843. The society's formation was a result of the highly emotional discord within the Methodist Episcopal Church over the issue of slavery in America. John Wesley and early American Methodist leaders had always denounced human slavery, but the economic advantages of slavery involved many ministers and members of the Methodist Episcopal Church in slaveholding. A group of ministers in the New England Conference began agitating for abolition, only to have bishops attempt to silence them.

Thus, the divisiveness over slavery within the Methodist church was not isolated to Seneca Falls; efforts by Wesleyans to sever connections began as early as 1841. The first Wesleyan Methodist conference met in Michigan that year, and in 1842 the True Wesleyan began publication. The first formal meeting for organizing the Wesleyan Methodist Church occurred at the Andover Convention in Andover, Massachusetts, in February 1843. A second convention was held in Utica, New York,

1. True Wesleyan, March 4, 1843.

beginning May 31, 1843, and it was here that Reverend George Pegler's services were secured for the new church in Seneca Falls. The split in the Seneca Falls Methodist Episcopal Church was thus part of a larger movement occurring in New England and the upper Midwest.²

In the events which led to the division of the Wesleyan Methodist Connection of America from the Methodist Episcopal Church in 1843 over slavery there was a strong reaction to the arbitrary methods of the Methodist Episcopal bishops. The new denomination began as a "connection," with the local church sovereign in its affairs. The churches were bound together in conferences; the new First Wesleyan Methodist Society of Seneca Falls belonged to the Rochester Conference.³

Building the Chapel

Meeting in a school house in district no. 1 in Seneca Falls, the earnest 60-70 Methodists organized themselves and resolved that their trustees negotiate for and purchase a "Lot for the erection of a house of

2. For further information on the formative years of the Wesleyan Methodist church, see: Ira Ford McLeister, History of the Wesleyan Methodist Church of America revised ed. by Roy Stephen Nicholson (Marion, Indiana: The Wesley Press, 1959), chapter V; and Encyclopedia of World Methodism, "The Wesleyan Church" pp. 2523-2524. "A History of The Wesleyan Church" (Marion, Indiana: Office of the General Secretary The Wesleyan Church, November 1982) p. 4, pamphlet. For a study of women in the Methodist Church, see: Hilah F. Thomas and Rosemary Skinner Keller, eds., Women in New Worlds Historical Perspectives on the Wesleyan Tradition (Nashville: Abingdon, 1981). For a description of the emotional breaking away of this group from the Methodist Episcopal Church in Seneca Falls, see chapter XXXVI of George Pegler, Autobiography of the Life and Times of the Rev. George Pegler (Syracuse, New York: Wesleyan Methodist Publishing House, 1879).

3. Correspondence with Paul W. Thomas, Director of Archives, Archives and Historical Library, The Wesleyan Church, Marion, Indiana, April 8, 1986.

Public Worship & also to circulate a Subscription to raise Money to buy a Lot & the Erection of Said house of Worship."⁴

Twenty-four members of the fledgling congregation pledged either money or service to build the chapel. Contributions of services included "tailoring," "work," "trimming Pulpit," "brick," "blacksmg," (blacksmithing) possibly supplying "produce," and "team work."⁵ Lot 100 at the corner of Fall and Mynderse streets was purchased on May 31, 1843, for \$600 from Harmon Desmond. On an 1836 map of Seneca Falls, this corner lot appeared as lot 60. In 1856 lot 60 was at the corner of Fall and State streets, where the Clinton House hotel stood, while the Wesleyan Methodist Chapel property is unnumbered. (See 1836 and 1856 Seneca Falls maps and details, illustrations 1 and 2 and 8 and 9.) The money was to be paid in eight years with annual interest.⁶

Joseph Metcalf, a farmer and brickyard owner, was an influential supporter of the chapel construction. Before the chapel was completed Metcalf's barn burned, along with his seed wheat and farming implements.

4. First Wesleyan Methodist Church Records, "Book No. 1 The Property of the First Wesleyan M. Church Seneca Falls NY" entry dated March 27, 1843, Seneca Falls, N.Y. Churches Collection, First Wesleyan Methodist Church Collection, Archives Collection 22, Box 1, Book 1, 1843-1871, Seneca Falls Historical Society. (Hereafter cited as SFHS.) This first book of records contains trustee meeting minutes. (Hereafter cited as First Wesleyan Methodist Church Records, "Book No. 1.") One Hundred Years of Service for Christ in the Wesleyan Methodist Church 1844-1944 (Utica, New York: n.p. 1944), p. 41. The trustees were: John C. King, H.L. Worden, Abram Failing, Elbert O. Lindsley, Joseph Metcalf and William Fox. H.L. Worden was chosen chairman and Abram Failing was secretary.

5. First Wesleyan Methodist Church Records, "Book No. 1," entry dated April 20, 1843.

6. First Wesleyan Methodist Church Records, "Book No. 1," entry dated May 31, 1843; History of Seneca Co., New York 1786-1876 (Philadelphia: Everts, Ensign & Everts, 1876; reprint ed., Ovid, New York: W.E. Morrison & Co., 1976), p. 113. Fall Street was so named because of the fall in the river and the grade of the street. Mynderse Street was named after Wilhelmus Mynderse, one of the original proprietors of Seneca Falls.

When Reverend Pegler offered condolences, Metcalf told him; "It is alright, Brother Pegler. Perhaps the Lord has taken this method to show me the uncertainty [sic] of my possessions. I must be more liberal with my property while I have it at my command. I have just heard that now my barn is burned the 'Scottie' meeting house will not be finished. Tell Brother Moyer to push the work, and I will foot the bill."⁷ Metcalf made an initial subscription of \$500 toward the chapel construction in April 1843.⁸ An early resident of Seneca Falls remembered that the brick "for what is now Johnson's hall, was furnished by Elder Joseph Metcalf, who had a brickyard at his farm 1½ miles north of Seneca Falls."⁹

Entries in the True Wesleyan chronicle the construction throughout the summer of 1843. A July 22 description of the work also revealed the hopes of the new congregation: "Our new church is of brick, 43 by 64; is on a good site, and will have galleries on three sides, and we humbly trust, when finished, will become the birth-place of many."¹⁰ When the Reverend George Pegler arrived in Seneca Falls to become the

7. One Hundred Years of Service, p. 41. The local newspaper reported the barn burned when some boys attempted to burn out a wasp's nest located in a shed next to the barn. Metcalf lost 300 or 400 bushels of wheat, plus oats and hay. The estimated loss was \$300 with no insurance. Seneca Falls Democrat, September 7, 1843. Joseph Metcalf was born in Massachusetts and came to Seneca Falls with his family in 1811. He was one of the most active and prosperous farmers in the area, and contributed liberally to the Methodist congregation, as well as later to the Wesleyan Methodists. His obituary stated, "The first Wesleyan church edifice was built mostly through his efforts and by his means. [sic] He also contributed generously toward every good work of the church and in his religious convictions was uncompromising and enthusiastic." He died in 1869 at age 84. Scrapbook, "History of Seneca Falls From 1787 to 1873 From Scraps saved by Mrs. C.O. Goodyear," p. 52, SFHS.

8. First Wesleyan Methodist Church Records, "Book No. 1," entry dated April 20, 1843.

9. James S. Sanderson, "Some Early Recollections of Seneca Falls" in Papers read before the Seneca Falls Historical Society For the Years 1911-12, p. 59. This article may be found in Seneca Falls Historical Society Papers 1904-1911/12.

10. True Wesleyan, July 22, 1843.

congregation's first pastor, he saw the chapel being built. He described it as "of larger dimensions than any other church in the village."¹¹ By September the chapel was nearly completed. Pegler remarked: "The pulpit slips and altar alone were unfinished, and the contractor was pushing the work as fast as possible."¹²

The Wesleyan Methodist Chapel was finished in October 1843 at a cost of \$1,770.¹³ The imminent Reverend Luther Lee of Andover, Massachusetts, known for his antislavery work, dedicated the chapel on October 14. Services began at 10:00 A.M. under stormy skies and continued throughout the day and into the evening. Reverend Lee's text was taken from 2d Chronicles, 6-18, and the congregation was "very attentive. . . ." Even though the storm continued into the evening, making the streets very muddy, more people attended the night service, presided over, once again, by Reverend Lee. (See illustration 3 of Reverend Lee.)¹⁴

The chapel was, according to Reverend Lee, "of brick, 44 x 64, with a gallery on three sides, and is well finished, though, as it should be, it is plain. We have a good society here, as may be inferred from the fact that they have finished such a house in so short a time."¹⁵ Another description of the chapel, written by an attendee at the dedication, appeared in the True Wesleyan newspaper the next month: "We arrived there about the hour of assembling for worship, and went up to the chapel, and found a large building, I think 60 by 40 feet, built of brick, in a neat and plain manner."¹⁶

11. Pegler, Autobiography, p. 409.

12. *Ibid.*, p. 414.

13. History of Seneca Co., p. 113.

14. True Wesleyan, September 30, 1843; *Ibid.*, November 4, 1843. Notices of the dedication also appeared in the local Seneca Falls Democrat on October 5 and 12, 1843.

15. True Wesleyan, October 28, 1843.

16. *Ibid.*, November 4, 1843.

The Wesleyan Congregation 1843-1869

In April 1848 the trustees resolved to secure insurance for the chapel, resulting in Joseph Metcalf obtaining a policy for \$2,000 with the Montgomery Mutual Insurance Company in April 1850.¹⁷ In April 1863 the trustees were instructed to loan money "on Mortgage on Church Property" for no longer than six years to pay the indebtedness of the church. The trustees were to discharge the indebtedness.¹⁸ A committee was appointed in May to solicit subscriptions to pay the more pressing claims against the church, and as many others as possible.¹⁹

The chapel then served as a home for the Seneca Falls Wesleyan Methodists until 1872. The first session of the Rochester Conference was held in the "brick meeting house of the Wesleyan Church" in April 1845. Forty-one elders, 23 laymen and 20 applicants for orders attended the conference, over which Reverend Pegler presided. Pegler then became a traveling evangelist, and the chapel's congregation received their second pastor, Reverend Samuel Salisbury, a "strong abolitionist." (See illustration 4 of Reverend Salisbury.)²⁰

17. First Wesleyan Methodist Church Records, "Book No. 1," entry dated April 25, 1850. An earlier reference to obtaining insurance is difficult to decipher. The April 3, 1848, entry has a note concerning assessments by the Mutual Insurance company for a policy of \$25.79. The handwriting preceding this figure is illegible, thus exactly what the money is for is not known.

18. See First Wesleyan Methodist Church Records, "Book No. 2, This Book contains an account of the proceedings of the business meetings of the Wesleyan M. Church of Seneca Falls NY," May 3, 1858 - August 3, 1863, entry dated April 20, 1863, Seneca Falls, N.Y. Churches Collection, Archives Collection 22, Box 1, Book 2, 1858 - 1863, SFHS. This second book of records contains proceedings of the church's monthly business meetings. (Hereafter cited as First Wesleyan Methodist Church Records, "Book No. 2.")

19. First Wesleyan Methodist Church Records, "Book No. 2," entry dated May 4, 1863.

20. Manual of the Churches of Seneca County With Sketches of Their Pastors 1895-1896 (Seneca Falls, New York: Courier Printing Company, (Continued)

In July 1845 Reverend Salisbury publicly answered charges made against the Wesleyan Chapel and its congregation by M. Tooker, presiding elder of Ontario district, Genesee Conference. Salisbury's response reveals an insight into the chapel's location within the village of Seneca Falls. Tooker stated that predictions were made that the chapel would be transformed into a store within a year from its erection. Reverend Salisbury responded that not only could he find no one in Tooker's church who knew of such predictions, but he added: "no man in his senses would be likely to predict such a thing of a house standing in the back part of the village--where no one would open a store, even if the house was given to him." Salisbury then asserted that his congregation consisted in June 1845 of more than six dozen members, with some added since then.²¹

20. (Cont.) 1896), p. 171; True Wesleyan, May 10, 1845. The name of this pastor is found as Salisbury, Saulsbury and Salsbury. He was born in Herkimer, New York, in 1804, and moved to Orleans County, New York as a child. He served as a school teacher for several years before beginning his ministry in the Methodist Episcopal church at the age of 25. In 1843 he withdrew from this church and helped form the Wesleyan Methodist church. "He was noted for his fine qualities both as a pulpit orator and for his genial, noble and manly ways as a citizen and gentleman." Salisbury was an abolitionist who incurred the wrath of Southern sympathizers and endured danger to his life because of his strong stand. He died in 1874. Edgar L. Welch, "Grip's" Historical Souvenir of Seneca Falls (Syracuse, New York: n.p., [1904], p. 100; Portrait and Biographical Record of Seneca and Schuyler Counties New York, (New York: Chapman Publishing Co., 1895), p. 487. The pastors who served the Seneca Falls Wesleyan Methodist congregation while in the Wesleyan Chapel were: George Pegler 1843-1845; Samuel Salisbury 1845-1847; Saron Phillips 1847-1849; Benjamin Bradford 1849-1852; D.B. Douglas 1853-1855; S.B. Loomis 1855-1857; J.A. Swallow 1857-1858; Horace Barton Knight 1858-1861; William S. Bell 1861-1863; Horace Barton Knight 1864; William W. Lyle 1865-1869; Adam Crooks 1869; Marshall Frink 1869; Samuel Salisbury 1870-1872. Manual of Churches, pp. 171-172; History of Seneca Co., p. 113. Marshall Frink's name appeared in these secondary sources as Flint, but in the contemporary newspapers as Frink.

21. True Wesleyan, July 19, 1845.

Sometime during the Reverend D.B. Douglas' pastorate, 1853-1855, a grand revival was held at the chapel, resulting in increased membership. The remaining church debt of \$2,500 was paid at this time. During Reverend S.B. Loomis' pastorate, beginning in 1855, the congregation united with other local denominations in holding open air meetings. In the winter of 1858-1859 another revival, held during Reverend Horace Barton Knight's pastorate, added more members to the chapel congregation.²²

During this period of national political agitation over slavery, the chapel's members were apparently involved with the Underground Railroad for helping slaves escape into Canada.²³ These references to both the chapel and the activities of its congregation, imply that antislavery sentiments, which gave rise to the church in 1843, continued to be doctrines the Wesleyan Methodists adhered to and practiced.²⁴

22. Manual of Churches, pp. 171-172. This source stated 118 members were added, while a local newspaper stated in February 1859 that "over forty" conversions had taken place. American Reveille, February 12, 1859. The paper also remarked: "We know of no place that stands more in need of a genuine religious revival than this, and we trust that, if these meetings are beneficial, there will be no delay in carrying on the good work." Ibid., January 29, 1859. Many new members were admitted to the church and baptised in the chapel in 1859. See First Wesleyan Methodist Church Records, "Book No. 2," entry dated January 23, 1859; Ibid., February 6, 1859; Ibid., February 13, 1859; Ibid., March 13, 1859; Ibid., March 20, 1859; Ibid., April 3, 1859; Ibid., April 17, 1859; Ibid., May 24, 1859. A native of Vermont, Horace Barton Knight, served the Wesleyan Methodist congregation in Seneca Falls, was an agent for the American Wesleyan Book Concern in Syracuse, New York and was well known within his denomination. He was married to Mary Hillman Knight and fathered Horace W. Knight, a Seneca Falls businessman. By 1895 he was living in Colorado. Portrait and Biographical, p. 194.

23. Manual of Churches, p. 172. Ten years earlier the chapel had been described as the "Great Light House of Seneca Falls" and as the "Anti-Slavery Depot." However, one Reverend Joseph Cross, probably not an ardent abolitionist, referred to the chapel as the "Devil's Depot." True Wesleyan, February 10, 1849.

24. Emily Knight Huntington, the great-great granddaughter of Horace Barton Knight, cited family oral history that the Wesleyan Methodist congregation was divided over the slavery issue. Evidently some members hid escaped slaves or provided them transportation to Canada. Telephone interview with Emily Knight Huntington, Seneca Falls, New York, March 20, 1986.

An 1862 Seneca Falls history claimed the membership of the chapel that year to be "over 200," but added, "though many have removed beyond the privileges of the church, in consequence of the derangements produced by the war. The general condition of the church, however, is good, notwithstanding the embarrassments of the times."²⁵

Raising Money

The Wesleyans collected funds to finance church expenses in several different ways. Most consistent were the weekly collections and individual subscriptions. Sometimes extra collections were taken to defray expenses. Pews were rented in the 1860s. Donation visits were sometimes held to raise money to pay the minister's salary. In December 1860 the church's male members were invited to pay \$.10 per week and female members \$.05 per week to raise money to pay the pastoral salary. In January 1863 the trustees moved to raise the minister's salary by taxing the property and income of the members. Admission was charged for townspeople to view the chapel's Christmas Tree in 1866, and festivals were held several years to raise money.²⁶

25. Henry Stowell, "A History of Seneca Falls, N.Y. (1779-1862)" originally from Brigham's - 1862 - Geneva, Seneca Falls and Waterloo Directory (Seneca Falls, New York: Seneca Falls Historical Society reprint ed. April 1975 pamphlet) p. 18.

26. First Wesleyan Methodist Church Records, "Book No. 2," December 10, 1860; *Ibid.*, January 5, 1863; First Wesleyan Methodist Church Records, "Book No. 3, The Property of the First Wesleyan M Church Seneca Falls N.Y." entry dated September 7, 1863; *Ibid.*, October 5, 1863; *Ibid.*, December 3, 1866; *Ibid.*, April 8, 1867; *Ibid.*, January 6, 1868; *Ibid.*, February 3, 1868; *Ibid.*, April 6, 1868, Seneca Falls, NY Churches Collection, Archives Collection 22, Box 1, Book 3, 1863-1870, SFHS. This third book of records contains regular monthly meeting minutes. (Hereafter cited as First Wesleyan Methodist Church Records, "Book No. 3.") Sample newspaper entries advertising the pew rentals are the Seneca Falls Reveille, February 7, 1863; *Ibid.*, April 28, 1866; *Ibid.*, April 24, 1868. Sample newspaper entries advertising donation visits are the Seneca Falls Reveille, January 13, 1866; *Ibid.*, January 10, 1868. Hereafter cited as Reveille. This newspaper changed its title from American Reveille to Seneca Falls Reveille, with the June 23, 1860, issue.

Holding festivals was a common way for churches in Seneca Falls to raise money. The events usually took form as raspberry or strawberry festivals, held in Union Hall. Advertisements for the events ran in the local newspapers.²⁷ In July 1864 the Wesleyan congregation formed a "Committee on Hall and sale of tickets," as well as a "Committee on Lemonade" and a "Committee of all Work." The festival that year brought in \$126.66.²⁸ Another festival, held in July 1865, brought in \$229.69 from the "Several Tables," "Sale of Tickets," and other sources. Expenses included, among other items, eggs for \$6.29, strawberries for \$8.25, ice for \$5.55 and the rental fee for the hall was \$7.00. A profit of \$176.27 was earned. The trustees moved to use the money to pay the sexton, the gas bill, part of the floating debt, and that \$100 be used to pay the minister's salary. Some of the money was considered for use in purchasing an organ. The strawberry festival held in 1866 earned \$131.17. The 1867 festival earned \$125.41, and the money was applied toward the minister's salary. The 1868 festival only earned \$88.16.²⁹

Parsonage

A committee of four was appointed in December 1865 to look into obtaining a parsonage.³⁰ Evidently church member Chauncey Howe had been renting out a house to the pastor for \$40.00. In January 1862 the trustees gave Reverend William S. Bell a note so he could pay his rent; during that year Reverend Bell was living in a house at 5 Mynderse Street. On December 15, 1865, this committee reported that the house

27. See: Seneca County Courier, July 7, 1864; and Reveille, June 24, 1865; Ibid., June 30, 1866; Ibid., June 28, 1867; Ibid., June 26, 1868.

28. First Wesleyan Methodist Church Records, "Book No. 3," entry dated July 4, 1864; Ibid., August 1, 1864.

29. Ibid., entry dated July 3, 1865; Ibid., August 7, 1865; Ibid., August 6, 1866; Ibid., September 2, 1867; Ibid., July 13, 1868.

30. First Wesleyan Methodist Church Records, "Book No. 3," entry dated December 4, 1865.

and lot of a Mr. Partridge could be purchased for \$2,200. An initial payment of \$200 was needed, with the balance to be paid in five years. The trustees were then directed to purchase the property providing \$200 could be raised.³¹ In July 1866 Chauncey Howe read the mortgage "drawn by Miller on the Church property for the payment of purchase money of Parsonage." After some discussion the trustees moved that Reverend William W. Lyle draw up a "Mortgage And Bond" and present it to Mr. L.C. Partridge.³² In September, however, the trustees were instructed "to get (if possible) some one to buy the Parsonage or if not to make the best bargain they could with L C Partridge."³³ The month before, \$9.75 was paid for "Repr Parsonage." The meaning of this entry is not known. An additional entry stated \$50 was received for "Rent of House" on June 21. This probably refers to the rent paid to Chauncey Howe.³⁴

In June 1867 the trustees ordered that a "good house be built in the rear of the Church."³⁵ No house or other structure appears on the 1871 Seneca Falls map detail on the Wesleyan Chapel property. (See illustration 11.) Nothing more is known of a parsonage. Except for the address of 5 Mynderse Street for Reverend Bell in 1862, no addresses of other Wesleyan Methodist ministers were located in available Seneca Falls directories.

31. Ibid., entry dated December 15, 1865. An Erastus Partridge was president of the Bank of Seneca Falls, and lived at 23 Cayuga Street. His son, Leroy C., was a cashier at the bank and boarded at the same address. 1862 Seneca Falls Directory, pp. 36, 61. Abbreviated entries for the Seneca Falls directories are used in the footnotes for the sake of simplicity. For full citations, see the bibliography.

32. First Wesleyan Church Records, "Book No. 3," entry dated July 9, 1866. By 1867 Leroy C. Partridge had become the treasurer of the Phoenix Mills, and was a notary public and banker on Ovid Street, with an office at the First National Bank of Seneca Falls on Fall Street. Perhaps "Miller" was Josiah T. Miller, a lawyer with an office at 71 Fall Street. 1867 Seneca Falls Directory, pp. 177, 181.

33. First Wesleyan Church Records, "Book No. 3," entry dated September 10, 1866.

34. Ibid., entry dated August 6, 1866.

35. Ibid., entry dated June 2, 1867.

Wesleyan vs Congregationalist Controversy 1869

A severe crisis occurred in 1869 which led to a breaking away of part of the Wesleyan congregation. This was an attempt to change the group's affiliation from Wesleyan Methodist to Congregational. Over the course of two years prior to 1869 the congregation felt the effect of the agitation over the secret society issue. During the pastorate of Reverend William W. Lyle, questions of preservation of the connectional existence to the Methodist conferences agitated the church, in addition to whether membership in secret societies should be condemned.³⁶

In November 1867 the Wesleyan Methodist trustees moved and seconded a motion to disapprove of the action of the General Conference in enforcing a specific section of the Discipline. An amendment was offered and passed that no action be taken until the members received a copy of the Discipline.³⁷ The section referred to was concerned with membership in secret societies. The Discipline stated that on no account would memberships in secret societies, such as Free Masonry or Odd Fellowship, on the part of ministers or members be tolerated. This action confirmed an earlier resolution by the Rochester Yearly Conference at Eagle Harbor, New York, in 1847, which prohibited fellowship with secret, oath-bound societies. This action was taken on the following basis: "Resolved, That as Christians and Wesleyans we cannot identify our Christian and moral character with societies where women and colored persons are excluded."³⁸

36. Manua' of Churches, p. 172; One Hundred Years of Service, p. 41. Secret societies were oath-bound groups usually devoted to causes such as moral discipline or mutual assistance.

37. First Wesleyan Methodist Church Records, "Book No. 3," entry dated November 1867. No day was provided.

38. One Hundred Years of Service, pp. 15-16; Correspondence with Paul W. Thomas, Director of Archives, Archives and Historical Library, The Wesleyan Church, Marion, Indiana, April 8, 1986. The Wesleyan Methodist church records refer to this section of the Discipline as section 21 while the 1867 Discipline cited it as section 22.

On February 3, 1868, the trustees withdrew the resolution pertaining to the General Conference's action, and made another sustaining the conference's action. A vote was to be taken on this second resolution on February 9, and at that time the issue was discussed and voted down.³⁹

Reverend William W. Lyle, a firm believer in secret societies, had been pastor since July 16, 1865.⁴⁰ (See illustration 5 of Reverend William W. Lyle.) He also was a very active pastor. In 1866 he delivered a series of lectures in the Wesleyan Chapel on astronomy and natural philosophy. Admission to the lectures was \$1.00, with the proceeds going to the benefit of the church. One lecture was titled: "The Earth in Relation to the Solar System, Gravitation, Eclipses, &c."⁴¹ The pastor once delivered a sermon with political overtones. In October 1866 he talked on "The Moral Aspects of the Present Political Issues."⁴² Reverend Lyle also traveled the countryside delivering lectures on

39. First Wesleyan Methodist Church Records, "Book No. 3," entry dated February 3, 1868; *Ibid.*, February 9, 1868.

40. First Wesleyan Methodist Church Records, "Book No. 3," entry dated March 14, 1865; *Ibid.*, June 5, 1865; Seneca County Courier, July 13, 1865; Reveille, July 15, 1865. A reminiscence of Reverend Lyle, printed in 1911-1912, offers the following portrait of the pastor: "Rev. W.W. Lyle preached long sermons, but his congregation didn't care how fast or how slow the clock recorded time. Down the columned years comes the memory of his voice at a morning service in a far away June, 'Lift up your heads O! ye gates, and be ye lift up ye everlasting doors and the King of glory shall come in.'" Stephen Monroe, "Seneca Falls in Earlier Days. 'Should Old Acquaintance be Forgot.'" in Papers Read before the Seneca Falls Historical Society For the Years 1911-12, p. 35. This article may be found in Seneca Falls Historical Society Papers 1904-1911/12.

41. Reveille, April 14, 1866; *Ibid.*, April 21, 1866; Seneca County Courier, April 19, 1866.

42. The Reveille called the speech to the attention of "RADICALS!. . ." Our Radical brethren, of course, will see that the house is well filled and that the Republican Glee Club is in attendance." Reveille, October 27, 1866. The Seneca County Courier had an opposite viewpoint: "Mr. LYLE is an earnest Unionist, and believes that the principles of Christianity should control a man's action as much on election day as on any other day of the year. In other words, he believes in 'mixing religion with politics.'" Seneca County Courier, November 1, 1866.

temperance. Between June 1868 and October 1869, he traveled to Union Springs, Waterloo, Shortsville, Clyde, Penn Yan, Canandaigua and Manchester, New York.⁴³ During a Good Templars convention, held in Seneca Falls in March 1868, the Reverend Silas Ball, Grand Worthy Chief Templar of New York, delivered a temperance address in the Wesleyan Chapel. Reverend Lyle participated in the program.⁴⁴ He also delivered at least one temperance lecture in Waterloo under the auspices of the Good Templars in November 1868.⁴⁵ During the subsequent controversy over the ownership of the Wesleyan Chapel, Reverend Lyle traveled and organized Good Templars lodges in nearby towns. In February and June 1869 Lyle organized two lodges in Bristol, Ontario County, and one in Phelps. In September 1869 Lyle attended the Grand Lodge of Good Templars of the State, in session in Rochester.⁴⁶

Reverend Lyle, and those within the congregation and trustees who agreed with him, probably made their dissatisfaction with the General Conference's stand against membership in secret societies immediately known. By February 14, 1868, the Reveille reported:

It is stated that Rev. W.W. Lyle . . . has resigned his charge, in consequence of some difficulty respecting the rights and privileges of members of the Church who belong to secret societies. The narrow and illiberal ground is taken by some that membership in a secret society is an unsurpassable objection to Church fellowship. This view of the case, it is proper to say, is not entertained by the Pastor, hence the difficulty.⁴⁷

43. Reveille, June 5, 1868; *Ibid.*, November 13, 1868; *Ibid.*, November 27, 1868; *Ibid.*, December 11, 1868; *Ibid.*, January 15, 1869; *Ibid.*, January 29, 1869; *Ibid.*, July 23, 1869; *Ibid.*, October 29, 1869.

44. *Ibid.*, March 20, 1868. Good Templars was a secret society organized in the nineteenth century. Its members promoted total abstinence from alcohol.

45. Reveille, November 13, 1868.

46. *Ibid.*, February 5, 1869; *Ibid.*, June 11, 1869; *Ibid.*, September 24, 1869.

47. *Ibid.*, February 14, 1868.

The American Wesleyan reported that Reverend Lyle made an attempt to form a union with the Methodist Episcopal church. This attempt failed, and Lyle proceeded to cut the organization's connection to the Rochester Conference. Members were expelled, and the way cleared to become a Congregational church. Lyle and his followers then attempted to change the name of the religious corporation from the First Wesleyan Methodist Society of Seneca Falls to the First Congregational Society of Seneca Falls. "Ninety legal voters" presented a petition on January 18, 1869, to the trustees asking action be taken to change the corporate name of the society. The trustees moved that their president go to Waterloo and apply to the county judge to have the name changed. Four trustees voted aye to the motion, while one, David A. Deming, voted no. This action would have affectively cut off many members from their religious affiliation. Opponents of this move complained: "The great injustice of this act is indefinitely heightened by the fact that not one of its authors ever paid a single dollar for the erection of the building."⁴⁸

Trustee David A. Deming wrote the Reveille that less than one half of the church members, together with a number who attended worship who were not members, found the "Wesleyan doctrine too strict for them and wishing to be more popular and more conformed to the world have resolved to become Congregational." Deming stated the pastor was willing to go along with them, but wondered, where was their church? According to Deming:

48. American Wesleyan, May 12, 1869; First Wesleyan Methodist Church Records, "Book No. 1," entry dated January 18, 1869. Church records for April, June and July 1869, which pertain to the name change, were expunged from the official record in Book No. 3 on January 3, 1870. The proceedings are still readable, however. First Wesleyan Methodist Church Records, "Book No. 3," entry dated April 12, 1868; *Ibid.*, June 27, 1868; *Ibid.*, July 11, 1868, expunged; Reveille, January 22, 1869. The Reveille stated the number of names on the petition to be 92. *Ibid.*, March 19, 1869. The paper did not know if the majority of trustees favored becoming Congregationalists, but noted the "simon-pure" Wesleyans had declared "open war against all seceders and disturbers." *Ibid.*, January 29, 1869. This trustee's name appears as both Deming and Deming.

A manly, honorable course would be to go out and build one; but it will be less trouble and expense to get one already built, if they can; so they resolve as ingeniously and as secretly as possible to place their course before the county judge, hoping that he, by granting them a change of name, will give them control of the Wesleyan church property. This is the history--the sum and substance of the affair in a nutshell."⁴⁹

Of the 92 who signed the petition, only a "little over forty" were members of the church. The petition was matched by a protest, signed by more than 40 people, all of whom belonged to the church. Gilbert Wilcoxon served as counsel for the petitioners, while Charles A. Hawley and Henry Henion acted on behalf of the protestors. The petitioners offered five reasons for the change in church affiliation: that the Wesleyan Society had become "in usage and government" Congregational; that the society's affinity was with other Congregational churches; that a majority of the society's legal voters desired the change; "that the church edifice is in need of repairs and that funds cannot be raised for such repairs until a change is brought about"; and that the name sought designated the "true relation" of the society to the church "with which it is connected."⁵⁰ The protestors denied all these reasons, asserting the contrary. Affidavits from both sides were read, with the lawyers pleading both cases. A Judge Franklin then had the case at his disposal.⁵¹

Those opposed to Lyle's moves proceeded in April to instruct the trustees to relieve Lyle from serving the church as pastor.⁵² Not only

49. Reveille, February 12, 1869.

50. *Ibid.*, March 19, 1869. Henry Henion was a lawyer and insurance and real estate agent with an office over the post office in Seneca Falls in 1867. Gilbert Wilcoxon was a lawyer, insurance agent, and Seneca Falls supervisor in 1867. Charles Hawley was a lawyer and the partner of Josiah T. Miller, with an office at 71 Fall Street in 1867. 1867 Seneca Falls Directory, pp. 159, 177, 211.

51. Reveille, March 19, 1869.

52. First Wesleyan Methodist Church Records, "Book No. 4, The Property of the First Wesleyan M Church Seneca Falls N.Y" entry dated (Continued)

did members of the church wish to dismiss Lyle, but they voted on April 19 to dismiss the "so-called 'Executive Committee'" of the trustees, the church clerk/treasurer and the stewards. Joseph Metcalf motioned for the seats of the chapel to be free from May 1, 1869, for one year. This motion passed unanimously. A new clerk and treasurer was chosen, and

52. (Cont.) April 12, 1869, Seneca Falls, N.Y. Churches Collection, Archives Collection 22, Box 1, Book 4, 1869 - 1874, SFHS. This fourth book of records contains records of the Wesleyans during the Congregational split. Hereafter cited as First Wesleyan Methodist Church Records, "Book No. 4." The text of the resolution to relieve Lyle from his duties reveals much of the emotion involved with the dispute. It read as follows:

Whereas the Rev. W.W. Lyle the present pastor of this church is not a Wesleyan and will not be guided by our book of discipline nor administer the same, but has instituted other rules and regulations for the government of this Church; and Whereas his course for the past 2 years has been such as to Keep this church in a constant State of excitement: distracting and causing our members, to keep religious homes elsewhere: and Whereas, in view of the contradictory and unwise course which he has pursued, We, as Wesleyans, cannot concieniously followship him, or receive the Sacrament from his hands; and Whereas he has repeatedly Stated that he would not serve a divided church, and that he was ready to give up his pastorship When ever it was thought that such a course would restore harmony: and firmly believing that under his pastorship our unhappy church can never be united or made useful in promoting the cause of God in our midst; and Whereas more than one half of the Members of this church think it unwise and impolitic for him to remain longer with us as Pastor.

Therefore Resolved that the trustees of this church be, and are hereby instructed to relieve the Rev W.W. Lyle from serving this church as Pastor any longer. Resolved that the following resolution in regard to the dismial [sic] of Rev. W W Lyle be presented for adoption at the next business meeting of this Church. Ibid.

The Reveille on April 16, 1869, also attested to the rancor existing over the matter:

The strife and contention among the members of the Wesleyan Church in this village is assuming unpleasant proportions. . . . Whenever the contending parties come together, trouble commences, to the great disgrace and shame of all professing the least respect for the christian religion. Shame upon those who are the instigators and abettors of this disgraceful quarrel.

instructions given to the treasurer not to pay any money belonging to the First Wesleyan Church to the "So-called 'Congregationalist Church' of Seneca Falls NY." The dismissal of the executive committee was probably in anger over a previous purging of the church roll, for several people were readmitted to the church.⁵³

The attempt to change the congregation's status was made by appeal to the county judge, and several months passed before a court decision was made. In the interim several chapel members were arrested for "using the means necessary for entering their own house of worship, and for the purposes of worship. . . ."⁵⁴ The only details of this matter were provided by trustee David A. Deming:

As the idea has been ventilated to some extent that I committed an unlawful act in opening the church that the Wesleyans might hold a prayer meeting, I wish to say, in vindication of myself, that I, as one of the Trustees, had not only a right but it was my duty to do so. That Trustee who double-locked the church door and refused to open it for a prayer meeting, is the one who committed not only an unlawful act, but one that seems to me to be a relict of barbarism.⁵⁵

The Rochester Conference responded by sympathizing with those members opposed to changing the church's character. The conference declared the illegal expulsions from the church void, and refused to recognize Reverend Lyle as pastor of the Wesleyan Church at Seneca Falls.⁵⁶ In the meantime the Wesleyans looked into hiring another

53. First Wesleyan Methodist Church Records, "Book No. 4," entry dated April 19, 1869. A list of church members, dated May 1, 1868, appears in the back of Book No. 1. Many of the names have an X placed next to them, with dates in 1869. This may have been a working list for the purging or readmittance of members.

54. American Wesleyan, May 12, 1869. The church records indicate the trustees offered the use of the chapel, or would procure a hall, for the court's use "to try the matter relating to changing the name of this Society." First Wesleyan Methodist Church Records, "Book No. 3," entry dated February 8, 1869.

55. Reveille, April 23, 1869.

56. American Wesleyan, May 12, 1869.

minister. They also appointed a committee to confer with lawyers regarding serving an injunction to keep the trustees from paying Reverend Lyle, and to provide counsel regarding removing the trustees.⁵⁷

In the interim, when the chapel apparently was locked, the Wesleyans met in other churches for service. On one Sunday in August the Reverend Adam Crooks, editor of the American Wesleyan at Syracuse and the Wesleyan's pastor for a few months, preached to the society in the Presbyterian church.⁵⁸ In September a local newspaper stated that Reverend Marshall Frink, of the Syracuse Conference of the Wesleyan Methodist Connection, was going to preach in the "First Wesleyan Church" on Sunday, September 5, at 2:30 p.m. "If the Church is closed he will preach from the platform in front of the Church."⁵⁹

A court decision finally came in September, with the judge favoring the Wesleyans.⁶⁰ Evidently Reverend Lyle and his followers did not accept the decision in a Christian manner. On Thursday, September 9, 1869, the Wesleyan evening services were interrupted by Lyle's Congregationalists, who seized the subsequent Wesleyan pastor pro tem, Reverend Frink, out of a classroom and threw him into the street. Seventy-three year old Joseph Metcalf was "dragged from his knees while praying, kicked and stamped on," by "prominent members" of Mr. Lyle's group. Trustee David A. Deming was choked and abused, "he being the only one of the board that stands by the society and defends the rights of the Church." Other church members were also abused.⁶¹

57. First Wesleyan Methodist Church Records, "Book No. 4," entry dated May 17, 1869.

58. Reveille, August 6, 1889; History of Seneca Co., p. 113.

59. Reveille, September 3, 1869. The permanence or location of this platform is not known.

60. American Wesleyan, September 8, 1869.

61. *Ibid.*, September 29, 1869; Reveille, September 17, 1869.

On Sunday, September 12, church services were disrupted again. The Wesleyans found themselves locked out of their classroom. "Father Metcalf under the impulse of the moment came to the front of the gallery, and in a voice of thunder demanded of the trustees, in the name of the Lord of Hosts to open the doors."⁶² The Wesleyans finally held their meeting in the chapel vestibule. That evening a crowd of 700 gathered for service, only to be told there would be no services. The crowd quietly dispersed after singing the Doxology and pronouncing a benediction.⁶³

The Wesleyans promptly resolved on September 13 to notify Lyle that he was forbidden to enter the chapel, "or on any pretence step foot on said Church property."⁶⁴ On the same day Reverend Lyle wrote a letter to Abram Failing, president of the board of trustees of the First Wesleyan Methodist Society of Seneca Falls, which appeared in a local paper. He thought the scenes enacted the night before were "disgraceful to our village and a scandal to religion," and he could not preach until assurance was given that such events would not reoccur. "I hereby, therefore, respectfully notify you that I will neither preach in the church, nor conduct any religious services whatever in it until such times as rival claims to the property are either so far adjudicated as to be considered authoritative, or the proper authorities can give assurance that the scenes of yesterday and last evening will not be repeated."⁶⁵ Trustee David A. Deming approved of Lyle's decision, but remarked: "Your intimation of resuming services in the church, on certain conditions you name, is entirely gratuitous." Additionally, Deming stated the

62. American Wesleyan, September 29, 1869.

63. *Ibid.*

64. First Wesleyan Church Records, "Book No. 4," entry dated September 13, 1869.

65. Reveille, September 17, 1869. The newspaper remarked: "Mr. Lyle has come to a very sensible conclusion. An earlier decision of this kind on his part might have prevented the disgraceful scenes to which he alludes." *Ibid.*

violence against Frink and Metcalf occurred on Thursday night, and not Sunday morning, and that Lyle's mistake showed him to be "very forgetful or willfully dishonest."⁶⁶

The Wesleyans continued to print newspaper notices that services would be held in the chapel on Sundays, "at the usual hour of 10:30 also, if the house should be opened, prayer meeting at 6 and preaching at 7:30 P.M."⁶⁷ Whether the congregation met in the chapel is not known because the building evidently was kept locked. After the first court decision the Congregationalists had filed an injunction with Judge E. Darwin Smith of Rochester, to keep the Wesleyans from taking possession of the chapel. This action was dissolved on September 24.⁶⁸ After the decision was made, "six Congregational 'Locks three chains, two bolts and sundry screws, became loose, and were so far desolved [sic] by Sunday morning that the Wesleyans entered their house in peace, and with joyful and thankful hearts held service through the day and evening."⁶⁹

The Wesleyans thus repossessed their chapel, and by October 3 were holding services, reportedly, "in peace."⁷⁰ The announced guest pastor that Sunday morning was Reverend L.N. Stratton, of the Syracuse Conference of the Wesleyan Methodist Church. The Congregationalists,

66. Ibid.

67. Ibid., September 24, 1869; Ibid., September 17, 1869.

68. American Wesleyan, September 29, 1869; Ibid., October 27, 1869; The American Wesleyan on September 29, 1869, cited both the supreme court and the circuit court at Auburn, New York, as the source of the injunction's dissolution. A local paper cited the decision being made in the supreme court by a Judge Dwight. Reveille, October 1, 1869.

69. American Wesleyan, September 29, 1869. The Reveille remarked: "The implement with which the house was opened was a trifle stronger than the ordinary church key, but it served the purpose exceedingly well and may be considered an excellent agent in removing locks, bolts and bars, when applied by willing hands for religious ends." Reveille, October 1, 1869.

70. American Wesleyan, October 6, 1869.

who were holding services at Daniels' Hall, responded by issuing "hand-bills, falsely asserting that 'no preaching or other religious exercises would take place at the Wesleyan Church on Sunday,' at the same time forbidding all persons from entering said church or upon said premises, under penalties of the law."⁷¹ Trustee Deming, however, opened the building that morning and "no Samson was present to pull down its pillars upon offending heads. Brother Stratton preached in the face of this Congregational bull, and the faithful were present to hear him."⁷²

Yet the trouble was not over. According to the Reveille, "Deputy Sheriff O'Neil was stationed at the door on Sunday morning [October 10] to prevent the church from being opened, but he was unsuccessful. The doors were opened in some way and the Wesleyans permitted to enter their building and hold service. What next?"⁷³

What came next was more legal action and physical takeovers of the chapel by the Congregationalists. Having failed in several legal actions, and having had their injunction dissolved, the Congregationalists hired Rochester lawyer George F. Danforth. Several of the Congregationalists then claimed to be pew members in the chapel, brought action against four Wesleyans, and obtained another injunction to keep the Wesleyans out of the building. The Congregationalists then occupied the chapel for two Sundays. On October 26, 1869, a motion was made at the supreme court in Rochester to end the injunction, with Charles A. Hawley urging for

71. Reveille, October 8, 1869.

72. Ibid. The Reveille urged that village authorities protect the Wesleyans in their efforts to keep control of their property, "against all disturbers, seceders and dissenters." Ibid.; American Wesleyan, October 13, 1869.

73. Reveille, October 15, 1869. This deputy sheriff probably was Martin O'Neil, for many years the constable and justice of the peace in Seneca Falls. He died in 1906 at age 85. Ibid., December 14, 1906.

the Wesleyans. Chief Justice Thomas A. Johnson decided the case in favor of the Wesleyans and the injunction was dissolved.⁷⁴

The Congregationalist response was to go to the chapel, remove "the carpet, stoves and other fixtures," and return to Daniels' Hall.⁷⁵ Another account stated that "stoves, carpets, movable seats, organ, clock, coal boxes & c., were taken away," and that the Congregationalists had "sadly torn and mutilated" the chapel.⁷⁶ After this happened the Wesleyans cleaned the chapel, and through the generosity of member Anna Rumsey, purchased new carpets, stoves, oilcloths and other fixtures. The classroom was swept and a few seats were fixed to hold prayer meeting.⁷⁷

More disturbances followed. On Sunday, October 31, Congregationalists again entered the chapel and interrupted the morning services. According to the Reveille:

The Rev. Mr. Frink, of the Wesleyan Society, occupied the pulpit, and had scarcely finished prayer, when Rev. Mr. Lyle, of the Congregational Society, entered the house, and, advancing two-thirds of the way up the aisle, commanded Mr. Frink, in a loud and excited manner, to leave his pulpit. Mr. Frink gave no heed to Mr. Lyle, but attempted to proceed with the service, when Mr. Lyle still more excitedly repeated his command. At this point several of the Congregationalists gathered around their pastor, and it was believed by some that an attempt would be made to drag Mr. Frink from the desk. The greatest excitement prevailed among those present. Some were singing, others talking and shouting, when Mr. Lyle for the third time repeated his demand. A moment before this, however, a dozen or more Wesleyans went up in front of the

74. Ibid., October 29, 1869; American Wesleyan, November 3, 1869. The Congregationalists who brought the action were Rufus C. Dunham, Thomas J. Crosbey and others in the interest of Lyle, against David A. Deming, Alfred Brim and others, representing the Wesleyans.

75. Reveille, October 29, 1869.

76. American Wesleyan, November 3, 1869.

77. Ibid., Reveille, November 5, 1869.

pulpit, determined to defend it from the assaults of the rioters at whatever sacrifice. This very prudent step on their part had its effect, and doubtless deterred the Lyleites from whatever further disgraceful proceedings they had contemplated. As soon as Mr. Lyle discovered that he could not longer disturb the meeting with impunity, he announced that the congregation was dismissed, and beat a hasty retreat from the church, followed by a few of his faithful adherents. Mr. Frink then quietly proceeded with the Service, much to the satisfaction and pleasure of the large audience assembled.⁷⁸

The American Wesleyan printed another account of this disturbance:

After prayer meeting, brethren Frink and Tripp entered the pulpit and led in the usual services of opening public worship. Hymn sung, prayer offered, scripture read, second hymn announced, when just at this point, Mr. Lyle, followed by a few supporters, marched up the aisle, halted in the altar, declared himself the pastor of the First Wesleyan Society of Seneca Falls, and three times commanded that the pulpit be vacated. At this juncture brother Demming, trustee in the Wesleyan interest, approached the altar from the other aisle, followed by a number of supporters, not members of any Church. Some sisters sung charmingly, and in full tone. A brief period of suspense ensues. The pulpit is not vacated. Mr. Lyle declared the meeting dismissed, announced that he would preach at Daniels' Hall, and left the Church followed by a few supporters and sympathizers, Brother Frink preached a good sermon on the subject of prayer. Preaching by brother Frink again in the evening. No molestation.⁷⁹

Five Wesleyan trustees published a notice on November 5 that Reverend Lyle was not the Wesleyan pastor, and had not been since April. David A. Deming, Chauncey B. Howe, Joshua W. Wright, Alfred W. Brim and Frederick Rema also asserted that Abram Failing, William Smalley, Edwin Medden and William L. Bellows were not members of the board of trustees, and that no act of theirs was binding on the Wesleyan Methodist Church and Society.⁸⁰

78. Ibid., November 5, 1869.

79. American Wesleyan, November 3, 1869.

80. Reveille, November 5, 1869.

New controversies arose over the taking of the Wesleyan property from the chapel. Several Congregationalists asserted the property had not been stolen, but rather, collected to repay an old debt. Trustee Lyman F. Crowell maintained that William L. Bellows had loaned money to the First Wesleyan Methodist Society several years previously to pay a pressing debt. He had not even received any interest on the loan even though he repeatedly reminded the trustees of the outstanding debt. When the current problems arose, Bellows took action to recover his money because he believed he would never be paid. He hired a lawyer for collection, and the Wesleyan property was removed by a sheriff, to repay the past debt.⁸¹

At the same time, the current trustees gave notice they would pay all legal claims against the First Wesleyan Methodist Society, but that all efforts of force to obtain Wesleyan possessions would be resisted. This was in response to an attempt being made to sell the Wesleyan property at a sheriff's sale on December 28, to pay claims by Congregationalists. The five trustees, Deming, Howe, Wright, Brim and Rema, asserted this effort "by a pretended [sic] board of Trustees" to sell the property was being done not to pay debt past indebtedness of the society, but to transfer the property into Congregationalist hands.⁸²

The property question was finally settled, amicably, somehow, in December. The Wesleyans retained the chapel and the personal property not taken by the trustees who left. The Congregationalists paid all debts against the society and relinquished all claims against the property. In addition, according to Reverend Marshall Frink, "The seceding parties are bound to pay all the debts against the church and relinquish all claims, leaving the Wesleyans in quiet possession, by the payment on their part of \$2,000. Five hundred added to this will nearly or quite cover the loss sustained financially by them in consequence of the rupture."⁸³ This is

81. Ibid., November 12, 1869.

82. Ibid.

83. Ibid., December 10, 1869.

interpreted to mean the Wesleyans helped pay a portion of the debt, in addition to paying their legal fees.

Yet the Wesleyans were not "disheartened" after this long struggle. Reverend Frink and his congregation were "resolved to make an effort to put their church edifice in complete repair, modernizing all the fixtures and arrangements inside, and also rendering its outside, in architectural finish, an ornament to the village."⁸⁴ During the subsequent Quarterly Meeting held at the chapel, "Hearts were tender and grateful," and the congregation "voted to extensively repair their Church edifice."⁸⁵

Reverend Frink soon left this pastorate for other duties. According to the Reveille, "His firmness, patience and perseverance, so conspicuously displayed in defence of the right, contributed largely to a satisfactory adjustment of the difficulties. . . ." In March 1870 Reverend Samuel Salisbury of Wayne County was invited to return and become pastor a second time. He assumed his duties by May.⁸⁶

The Congregationalists continued to meet in Daniels' hall for services, leasing the space.⁸⁷ By March 1870 the First Congregationalist Church had purchased a site for a new church and obtained building materials. They broke ground for a brick church on State Street in June 1870, cornerstone ceremonies were held on August 19, 1870, and one of the rooms was first used for services on January 1, 1871. The structure was dedicated September 21, 1871.⁸⁸

84. Ibid.

85. American Wesleyan, January 5, 1870.

86. Reveille, March 18, 1870; Ibid., April 15, 1870; Ibid., May 6, 1870.

87. Ibid., October 1, 1869; Ibid., December 10, 1869.

88. Ibid., March 4, 1870; Ibid., July 1, 1870; Mrs. Philo Cowing and Rev. S.F. Frazier, "Early Churches of Junius," in 100th Anniversary of the Town of Junius. Historical Papers Read before the Seneca Falls (Continued)

The first indication that the Wesleyans had changed their minds and were not going to repair the chapel appeared in the meeting minutes of March 21, 1870. Anna Rumsey motioned that a church be built on the lot at the corner of Fall and Clinton streets.⁸⁹ The motion, however, was withdrawn after some discussion. Another motion, that the Wesleyans purchase the lot on the corner of Fall and Clinton streets from Charles G. Corwin, a trustee of the Wesleyan congregation, was then withdrawn. Corwin had purchased this lot for \$2,000 from a John Blain by March 1870. A third motion carried unanimously, that of releasing Charles G. Corwin from his subscription of \$1,000, whenever he deeded sufficient land to the Wesleyans upon which to build a church. The Wesleyans further agreed to give Corwin \$1,000 for "balance of lots on corner Fall & Clinton Sts." Finally, a motion was made and carried to change the subscription lists from "Repairing to Building new church."⁹⁰

88. (Cont.) Historical Society, p. 34. This article may be found in Seneca Falls Historical Society Papers 1903-1911/12. Edwin Medden, "The First Congregational Church," in Centennial Anniversary of Seneca County and Auxiliary Papers published by the Seneca Falls Historical Society 2d Annual, 1904, p. 65. This article may be found in Seneca Falls Historical Society Papers 1904-1911/12. Another history of the Congregational Church can be found in Reveille, November 16, 1849. Ironically, in November 1872 the women of the Congregational Church gave a supper, the proceeds going toward paying the church debt, in Johnson Hall, the former Wesleyan Chapel. Reveille, November 15, 1872.

89. Clinton Street was named for Dewitt C. Clinton, governor of the state of New York.

90. First Wesleyan Methodist Church Records, "Book No. 4," entry dated March 21, 1870; Reveille, March 4, 1870. Charles G. Corwin, born in 1825, owned and farmed 75 acres of land in Tyre, New York with his wife Helena. In Seneca Falls he was in business by 1874 with Cyrus Garnsey selling agricultural implements and musical instruments. He lived on Clinton Street, between Chapel and Oak streets, and died in January 1881. Building-Structure Inventory Form, NYS Office of Parks, Recreation & Historic Preservation, Division For Historic Preservation, "Charles Corwin House, 7 Mynderse St," prepared by Rick Bernstein and Margaret McFadden, August 1985, item 20; 1874 Seneca Falls Directory, pp. 40, 111.

In April Anna Rumsey was given the power to find buyers for the chapel, but in June she was excused, and replaced by Alfred W. Brim.⁹¹ In July a motion was made that the subscribers for building the church be assessed enough money to pay the indebtedness of the "Old Church Property," but after discussion the motion was withdrawn. By August there was "much talk concerning building new edifice."⁹² Sometime between September 5 and October 24 the trustees were instructed to petition the county court to grant an order for selling the chapel and grounds so a new church could be built. By October 24 this permission had been received.⁹³

In November 1870 Charles G. Corwin withdrew his offer for the chapel "as term of could not be complied with, time having elapsed."⁹⁴ In January 1871 Corwin motioned that the trustees raise \$1,100 to pay the indebtedness on the chapel through a subscription of the chapel members.⁹⁵ Thus, trustee Charles G. Corwin was a central figure, not only in supplying the lot for the new church, but also in the disposition of the old chapel. Corwin purchased the Wesleyan Chapel for \$5,000 on October 31, 1871.⁹⁶

91. First Wesleyan Methodist Church Records, "Book No. 4," entry dated April 4, 1870; *Ibid.*, June 6, 1870.

92. *Ibid.*, entry dated July 5, 1870; *Ibid.*, August 12, 1870.

93. *Ibid.*, undated entry "Special Meeting"; *Ibid.*, October 24, 1870.

94. First Wesleyan Methodist Church Records, "Book No. 1," entry dated November 7, 1870.

95. *Ibid.*, entry dated January 9, 1871.

96. *Ibid.*, entry dated March 11, 1871; History of Seneca Co., p. 113; Reveille, February 10, 1871; Deed Book 82, p. 48, October 31, 1871, County Clerk Office, Seneca County Courthouse, Waterloo, New York. (Hereafter cited as SCCW.)

Financial difficulties delayed the completion of the new church for several years. In February 1871 material for the foundation was delivered, and brick work was done from June to September.⁹⁷ In November the Wesleyans began constructing a "session room," but this work was not finished until January 1872.⁹⁸ In the meantime, Thanksgiving, Christmas and New Year services were held, presumably in the old Wesleyan Chapel.⁹⁹ First services were held in the "Chappel connected with our new Church building" on Sunday February 4, 1872. The church at the corner of Fall and Clinton streets was finally completed and dedicated on August 11, 1875.¹⁰⁰

On occasion the Wesleyan Methodists continued to use the Wesleyan Chapel. In December 1872 friends of the pastor held a donation visit in

97. Reveille, February 24, 1871; *Ibid.*, June 30, 1871; *Ibid.*, July 14, 1871; *Ibid.*, July 28, 1871; *Ibid.*, August 11, 1871; *Ibid.*, September 15, 1871; *Ibid.*, September 29, 1871.

98. *Ibid.*, November 17, 1871; *Ibid.*, December 8, 1871. On December 29, 1871, the Reveille reported: "The Methodist Society will occupy their new Session Room for the first time on Sunday next," but on January 5, 1872, the paper added "The Wesleyan Society hope to complete the session room of their new church some time during the present month." *Ibid.*, December 29, 1871; *Ibid.*, January 5, 1872.

99. *Ibid.*, November 24, 1871; *Ibid.*, December 22, 1871, January 5, 1872.

100. First Wesleyan Methodist Church Records, "Book No. 4," entry dated February 4, 1872; History of Seneca Co., p. 113. This history also stated that "fronting west, in the rear of the main building, is the session-room, over whose entrance is placed the church name, with date, 1843, the same being the stone from the old church which stood on the east of the church lot." *Ibid.* A cursory examination in November 1985 of the present-day Assembly of God Church by the author failed to discover this stone. For details of the new church construction, see First Wesleyan Methodist Church Records, "Book No. 1," entry dated February 6, 1871; *Ibid.*, March 1, 1871; *Ibid.*, March 6, 1871. Book No. 7 of the First Wesleyan Methodist Church Collection also contains information concerning the church construction. Costs of windows, gas pipe, furnaces, seats and cushions are all detailed in addition to decorating decisions. See: First Wesleyan Methodist Church Records, "Book No. 7, Clerks Records First Wesleyan M. Church Seneca Falls N. Y.," 1874 - 1880, Seneca Falls N.Y. Church Collection, Archives Collection 22, Box 1, Book 7, SFHS.

the chapel, since remodeled into Johnson Hall. That Christmas the Sunday school children received presents, given them from a "large fine arch"; an event also held in Johnson Hall. That Christmas the Sunday school children received presents, given them from a "large fine arch"; an event also held in Johnson Hall.¹⁰¹ The Wesleyan Methodists remained in the church at Fall and Clinton streets until 1920, when they moved into a third church on Miller Street.¹⁰²

The Chapel Exterior

Details of the chapel's exterior are scarce. The few known references are concerned with village ordinances passed which require the construction of sidewalks or church records which mention gates or culverts. No photograph of the Wesleyan Chapel has been found. (See Appendix B for appearance of the Wesleyan Chapel in July 1848.)

It does not appear that Fall Street was paved at the time of the 1848 Women's Rights Convention. Reminiscences of Seneca Falls written by a Samuel Kline mention the streets:

There was no street paving in the early days. Fall street was a common dirt road, hub deep with stiff clayey mud in fall and spring, making travel extremely trying, and with finely pulverized dust in summer. There were sections of flagstone sidewalks on either side the street flanked by cobblestone gutters, but not many elsewhere. I distinctly recall the first attempt at paving Fall street. It was somewhere about 1850, a layer of coarse limestone rock was distributed over the surface, and a gang of men with long handled hammers were employed to break it up into small pieces. It was called a macadamized road, but fell far short of the specifications upon which these roads are constructed. It proved a poor sort of make shift and never answered the purpose satisfactorily. The broken stones soon ground into the soft earth, the mud oozing up and covering them and it proved little better than the ordinary dirt

101. Reveille, December 6, 1872; *Ibid.*, December 27, 1872.

102. One Hundred Years of Service, p. 43.

road, save the one exception, that the wheels of traffic hitting the sub-stratum did not sink so deep as before.¹⁰³

Twenty-three citizens of Seneca Falls petitioned the village board of trustees in May 1848 for "McAdamizing" Fall Street between the east line of Ovid Street and the crosswalk in front of James Sanderson's shop, which is shown on the 1856 Seneca Falls map as located halfway between State and Cayuga streets, well to the east of the chapel. This work occurred during the summer of 1848.¹⁰⁴ (See 1856 Seneca Falls map, illustration 8).

On March 14, 1848, the Village of Seneca Falls passed an ordinance requiring all residents on the west side of Mynderse Street from Fall Street to Chapel Street to build a sidewalk on their property.¹⁰⁵ The chapel trustees reponed by resolving to build a sidewalk, "in front of the Lot upon which the Chapel is built." They also wished to "compel the St[reet] Commissioner to build a Culvert over the ditches in front of this Lot."¹⁰⁶

In July 1850 the village trustees ordered a sidewalk built on the north side of Fall Street from State Street to the west side of Benejah Sherman's lot, located on the 1856 Seneca Falls map to the west of Walnut Street, to the west of the chapel. The sidewalk was to be "composed of

103. Samuel Kline, "Recollections of Seneca Falls Sixty Years Ago," undated (but with pencilled notation of ca. 1850s) newspaper clipping, Seneca Falls History Collection (General), Archives Collection 28, Box 1, Folder 5, SFHS.

104. Board of Trustees of Village of Seneca Falls, "Minute Book 1837-1855," pp. 472, 474, 478-479, 483. Ansel Bascom and William G. Van Cleef won the contracts for delivering 500 perch of stone each, at \$.50 per perch. In autumn 1985 the Village of Seneca Falls tax and board of trustees records were located in a vault within the old village offices on Fall Street.

105. Ibid., p. 462.

106. First Wesleyan Methodist Church Records, "Book no. 1," entry dated April 3, 1848.

Plank laid Crosswise and to correspond in width with the walk already built thereon."¹⁰⁷ At the same time, a sidewalk was to be built on both sides of Mynderse Street; on the west side from Fall Street to the last occupied lot. The sidewalk was to be composed of "plank one foot wide laid lengthwise eight inches apart--and filled between and on the outside with Gravel."¹⁰⁸

In the next year, May 1851, the trustees ordered a sidewalk be constructed six feet wide on the north side of Fall Street from E. Mynderse's dwelling house lot to the west line of George H. McClary's lot. (See 1856 Seneca Falls map, illustration 8.) The sidewalk was to be built of "Brick, Stone, or plank, the plank to be not less than twelve inches wide and two inches thick and not to be laid more than Six inches apart to be laid lengthwise and to be filled between and on the outside with gravel."¹⁰⁹ Additionally, owners of each piece of property were responsible for keeping the sidewalk and gutter clean, and for removing all snow and ice. The penalty for each offence was \$1.00. If the street were paved in front of the property, the owners were to scrape the street from the sidewalk to the center of the street and collect the dirt in heaps to be taken away.¹¹⁰

These sidewalks required frequent repair. The sidewalk on the west side of Mynderse Street was ordered built, or rebuilt, from Fall Street north in July 1852. This sidewalk was ordered built again in April 1854, June 1862, May 1863, August 1870 and May 1872.¹¹¹ The sidewalk on the

107. Board of Trustees, "Village Minutes," p. 573.

108. Ibid., p. 574.

109. Ibid., p. 598.

110. Ibid., p. 633.

111. Ibid., pp. 638, 698; Board of Trustees of Village of Seneca Falls, "Minute Book 1856-1872," pp. 323, 359, 717, 771.

north side of Fall Street in front of the chapel was built, or rebuilt in June 1861, July 1865, May 1866 and October 1866.¹¹²

The Wesleyan Methodist church records often correspond with the sidewalk repairs mentioned in the village records. Additional dates were sometimes given. A chapel sidewalk was relaid in July 1861. The village trustees ordered the Wesleyan Chapel congregation in June 1863 to lay a new sidewalk on Mynderse Street, the length of the chapel lot. Action was deferred. More than two years later, in 1865, the Wesleyan trustees were directed to repair the sidewalk. Six dollars were paid for "Building Walk" in August 1866. Thirty-seven cents was spent on "repairing Walk" in January 1867. The Wesleyan trustees were instructed to repair the sidewalk on the east side of the church lot in October 1868.¹¹³

A stoop and a walk from the stoop to the gate were built in September 1865 at a cost of \$23.43. The stoop was also painted.¹¹⁴

After several thefts of chapel property occurred in 1869 the trustees directed the sexton to fasten the "Gates of the Church Yard and to keep them fastened except at such times as may be nessecary [sic] to have them opened for the usual Services of the Church, and that the Class Room, be locked on Sabbath."¹¹⁵

The chapel doors were mentioned in connection with the Wesleyan-Congregationalist dispute. On September 12, 1869, people

112. Board of Trustees, "Minute Book 1856-1872," pp. 277, 448, 514, 531. This listing of repairs should not be considered complete.

113. First Wesleyan Methodist Church Records, "Book No. 2," entry dated July 8, 1861; Ibid., June 1, 1863; First Wesleyan Methodist Church Records, "Book No. 3," entry dated October 2, 1865; Ibid., August 6, 1866; Ibid., January 21, 1867; Ibid., October 12, 1868.

114. First Wesleyan Methodist Church Records, "Book No. 3," entry dated September 11, 1865; Ibid., October 2, 1865.

115. First Wesleyan Methodist Church Records, "Book No. 1," entry dated September 10, 1869.

gathered for an evening prayer meeting. "At seven o'clock the outside doors were opened by the sexton. But not a jet of gas was lighted. The inside doors were not opened at all, and about eight o'clock the doors were closed again. . . ."116

A back fence is mentioned in December 1862. The trustees were ordered to move the fence "in the rear of the Church lot to be property line of said lot."¹¹⁷

Only one reference to an outbuilding has been found. In March 1870 part of the roof "to the shed belonging to the Wesleyan church" fell from the weight of accumulated snow.¹¹⁸ This shed may be what is represented on the 1856 Seneca Falls map as an oblong structure, located to the northwest of the chapel. (See 1856 Seneca Falls map detail, illustration 9.)

Mary Sherwood Bull, an attendee at the 1848 Women's Rights Convention, provided only meagre clues as to the chapel's exterior appearance in her 1880 remembrance of the event. On the first day of the convention the "doors of the chapel were barred by bolts drawn upon the inside," and the only means of entry was through the windows. "But these windows were so high from the ground that no one but a man or tall climbing boy could scale them."¹¹⁹

Maps of Seneca Falls in 1856 and 1871 show only that the Wesleyan Chapel was rectangular shaped. (See Seneca Falls maps, 1856 detail and 1871 detail, illustrations 8 and 10.) Descriptions of the chapel at the time of its dedication in 1843 say only that it was "plain" and of brick.

116. American Wesleyan, September 29, 1869.

117. First Wesleyan Methodist Church Records, "Book No. 2," entry dated December 8, 1862.

118. Reveille, March 25, 1870.

119. Robert E. Reigel, "'Women's Rights and Other 'Reforms' in Seneca Falls:" A Contemporary View," New York History 46 (January 1965):49.

The only known sketch of the chapel exists on an 1856 cadastral map, drawn by J.H. French, and this structure is thought to be the chapel only because of its location behind the Arnett Mill. This sketch also reveals the chapel to be a rectangular brick structure. (See illustration 6.) No further data on the chapel's exterior has been found. (See section in Recommendations for Further Research concerned with the search for a photograph of the Wesleyan Chapel.)¹²⁰

120. Church architectural historian Andrew Landale Drummond provided a history of Methodist "chapel" architecture in Great Britain which gives a general understanding of the architectural style's evolution and meaning:

It was only at the time of the Methodist Revival that the familiar term "chapel" became generally used to denote what had previously been known as a "meeting-house." The change was not happy. "Meeting-house" suggests an unpretentious Puritan place of worship. . . . in America at least the name "Meeting-House" denoted a trysting-place for the Christian and his God; it was plain, no doubt, but plain in the same way that the Holy of Holies in the Jewish Temple was unadorned--the abiding-place of the Presence. Whether or not this is true of the early Puritan place of worship, "Meeting-House" suggests the beauty of simplicity: "chapel" is non-descript. . . . Methodist "chapels" were originally built as preaching-houses subsidiary to the "churches" of the Establishment, where the Sacraments were administered; it was a rough-and-ready distinction between a "Predigtraum" and a "Sakramentsraum." The fact that the chapels were intended by Wesley to be merely supplementary to parish churches may have had something to do with their complete lack of the charm associated with the older type of meeting-house. The opposition of the ecclesiastical authorities made Wesley the Churchman all the more ready to make his organisation appear to be a Society within the church with its own halls, rather than a rival Church with clergy and regular places of worship. The unecclesiastical origin of Methodism, its rapid and centralised development with limited financial resources, and the fact that its adherents came from the working people rather than from the comfortable tradesmen and merchants of the "Old Dissent," accounts for the dismal standardised chapel of brick or stucco. This type sprang up mushroom-like during the first half of the 19th century, particularly in new industrial centres. By this time the Industrial Revolution had broken down the good traditions of Georgian craftsmanship, and by the middle of the 19th century commercialised "builder's Gothic" completed the transition from honest simplicity to sheer vulgarity. Andrew Landale Drummond, The Church Architecture of Protestantism An Historical and Constructive Study (Edinburgh: T & T Clark, 1934), pp. 45-46.

The Chapel Interior

References to the chapel's interior appearance are few. The church records contain only scattered details of rooms, stairs, and aisles. Several rooms are mentioned, but these might have been referred to by different names throughout the years of Methodist occupancy of the chapel. Included are the "vestry,"¹²¹ "classroom,"¹²² "vestry room,"¹²³ "session room,"¹²⁴ "prayer-room";¹²⁵ and "conference room."¹²⁶ An altar is mentioned several times.¹²⁷

Interior furnishings are mentioned in the church records only very sparingly. Scattered references are usually related to the purchase or repair of items. The Wesleyans used stoves for heat, and regularly paid coal, coke and wood bills. Other furnishings mentioned include carpets, pews and the altar. The Sabbath school used handbooks, as did the choir, and in September 1868 maps were hung in the chapel permanently. Windows were regularly repaired, and glass and putty purchased. Occasionally paint and whitewashing was paid for, although the records do not tell where in the chapel this work was done. (See Appendix A for church record details of the chapel furnishings and small repairs.)

121. First Wesleyan Methodist Church Records, "Book No. 1," entry dated January 14, 1844; *Ibid.*, March 28, 1857; *Ibid.*, September 10, 1857.

122. *Ibid.*, entry dated February 3, 1844; First Wesleyan Methodist Church Records, "Book No. 2," entry dated February 3, 1862.

123. First Wesleyan Methodist Church Records, "Book No. 1," entry dated April 3, 1848.

124. *Ibid.*, entry dated January 18, 1869; *Ibid.*, March 18, 1869; *Ibid.*, April 6, 1869.

125. First Wesleyan Methodist Church Records, "Book No. 2," entry dated December 6, 1858; *Ibid.*, February 7, 1859; *Ibid.*, November 13, 1860; *Ibid.*, December 10, 1860.

126. *Ibid.*, entry dated August 2, 1858.

127. First Wesleyan Methodist Church Records, "Book No. 1," entry dated September 10, 1869; *Ibid.*, December 6, 1869.

By October 1856 gas works were being installed in Seneca Falls, with the buildings located on Fall Street at the village's west end. Partial lighting of the village occurred on June 11, 1857, and a "general illumination" was provided on June 12.¹²⁸ By September 1858 gas lighting had been installed in the chapel at a cost of \$100. Gas bills were paid thereafter. The gas pipes were enlarged throughout the years, and burners were replaced and provided for the pulpit. (See Appendix A for details of the gas bills and pipes in the chapel interior.)

Different arrangements were made during the years regarding chapel housecleaning. Committees, often composed of women, were formed to superintend the cleaning. "Broom" services were paid for, and a sexton was employed for general work, such as opening doors before chapel services, or lighting the gas lights. Stove cleaning, and other maintenance work was paid for throughout the years. (See Appendix A for data on housecleaning in the chapel.)

New members were accepted into the church membership through a profession of faith and by baptism by sprinkling at the altar.¹²⁹ This fact implies that a baptismal stood in the chapel. New members were also sometimes baptised, "before the public service," through immersion.¹³⁰ This may mean the immersion baptisms occurred in the river prior to services. In March 1859 the chapel's Reverend Horace Barton Knight, together with Reverend W. Rees of the Baptist church, baptised converts near the "Island Works," the Silsby, Mynderse & Co. furnace located next to the Seneca River.¹³¹

128. American Reveille, October 25, 1856; *Ibid.*, June 13, 1857.

129. First Wesleyan Methodist Church Records, "Book No. 2," entry dated January 23, 1859; *Ibid.*, February 6, 1859; *Ibid.*, February 13, 1859; *Ibid.*, February 27, 1859; *Ibid.*, March 13, 1859; *Ibid.*, April 17, 1859; *Ibid.*, May 24, 1859.

130. *Ibid.*, entry dated February 27, 1859; *Ibid.*, March 13, 1859; *Ibid.*, May 24, 1859.

131. American Reveille, March 5, 1859.

The chapel congregation suffered several thefts in 1869, some of which were connected to the breaking away of the Congregationalists. Details of these thefts provide data on the chapel's interior furnishings. The chapel was "forcibly entered" on April 14, 1869,¹³² and again on August 7, 1869. On the second occasion the board of trustees lost "certain articles of personal property to wit, One Sofa, One Mahogany Marble Top Table & four Sofa Chairs."¹³³ The trustees resolved in both instances to prosecute those responsible if found.

In September 1869 the chairman of the board of trustees was instructed to "purchase furniture for the Desk and Alter [sic] at a cost of not to exceed \$60."¹³⁴ In October the Congregationalists took stoves, carpets, a clock, coal boxes, the organ, movable seats and other items out of the chapel.¹³⁵

The chapel's congregation enjoyed musical accompaniment for their services, at least for a few years. Service was required to "tune the Melodian" in February 1862, a bill for \$.25 to "Fix Melodian" was paid in July. The trustees ordered the "Melodean" be sold to the highest bidder in November 1865.¹³⁶ The trustees were instructed to buy an organ in September 1865, for no more than \$400.¹³⁷

132. First Wesleyan Methodist Church Records, "Book No. 1," entry dated April 15, 1869.

133. Ibid., entry dated August 10, 1869.

134. Ibid., entry dated September 10, 1869.

135. American Wesleyan, November 3, 1869.

136. First Wesleyan Methodist Church Records, "Book No. 2," entry dated February 4, 1862; Ibid., July 7, 1862; First Wesleyan Methodist Church Records, "Book No. 3," entry dated November 6, 1865.

137. First Wesleyan Methodist Church Records, "Book No. 3," entry dated September 11, 1865; Phillips & Co. did unspecified damage to the organ in December; a restitution of \$30 was paid. Freight charges for the organ were \$4.97. Ibid., December 4, 1865.

Several more details of the chapel's interior can be gleaned from the American Wesleyan, which carried news items in 1869 concerning the trouble between the Wesleyans and the Congregationalists. When the September 9, 1869, services were interrupted, the minister was grabbed by the throat and "dragged from the class-room, down the stairs, out of the house and pitched into the street."¹³⁸ An observer of the disrupted proceedings on September 12, Reverend Marshall Frink, described the interior further. He obtained a good view of the proceedings because he had the "whole range of the pulpit settee" to himself. After the Wesleyans found themselves locked out of their "class-room," Joseph Metcalf "came to the front of the gallery," and demanded the trustees open the door. Frink stated, "I sat on the pulpit settee at the extreme end of the house opposite the gallery at the foot of the pulpit steps, were every thing could be seen. . . ."¹³⁹ Reverend Lyle's response to Metcalf's demand was to stand "with his back toward the gallery writing upon the blackboard [sic] in large letters that great word 'pardon.'"¹⁴⁰ The organist "turned upon his seat at this point," and then "put all the bass thunder upon the instrument." The Wesleyans then "quietly went down to the vestibule of the Church and there held their meetings."¹⁴¹

During the incident in October 1869 Reverend Lyle entered the chapel, "marched up the aisle, halted in the altar," and demanded three times for Reverend Frink to give up the pulpit. Trustee David Deming "approached the altar from the other aisle" in his attempt to prevent any further disturbance.¹⁴²

The only other known details of the chapel interior come from scattered references to the 1848 Women's Rights Convention. Mary

138. American Wesleyan, September 29, 1869.

139. Ibid.

140. Ibid.

141. Ibid.

142. Ibid., November 3, 1869.

Sherwood Bull, who attended the convention at age 14, published an article in 1880 in which she remembered "the old chapel with its dusty windows, the gallery on three sides, the wooden benches or pews, and the platform with the desk and communion-table, . . ." ¹⁴³ Since the convention was held in 1848, only five years after the chapel's completion, the building certainly could not be considered "old." Only one photograph of the chapel interior has been found. Taken ca. 1858, it is a portrait of the pastor, superintendent and teachers of the Sabbath school, and does not provide many interior details. Discernable details, presumably of the main sanctuary, are dark color pews, two stove pipes, two three-lap gas light fixtures, a centrally-placed frame wall feature (possibly part of the altar) and a monochromatic wall finish embellished with vertical lines. (See illustration 7 of chapel interior.)

Chapel Repairs

Data on repairs to the Wesleyan Chapel is meagre. Descriptions found in the Wesleyan Methodist church records and in local newspapers are very general, and offer little detail. It does appear, however, that extensive repairs occurred in 1857-1858, and that major repairs were needed by 1869-1870. At this time the congregation and its trustees decided to build a new church rather than repair the chapel.

In May 1855 the board of trustees clerk cryptically referred to the trustees considering the propriety of "repairing the Hous[e] yard & fence." A committee "on repairs" was appointed to superintend the work and to circulate a subscription to "defray the Expenses of the same. . . ." ¹⁴⁴

143. Riegel, "'Woman's Rights,'" : 50.

144. First Wesleyan Methodist Church Records, "Book No. 1," entry dated May 1855. No day was provided.

Two years later in 1857, the chapel trustees moved that "twen one dollars" be raised to pay "Brother F. Rema that the [?] towards repairing the Church." This ambiguous entry did not detail what type of repairs were needed or done.¹⁴⁵ A secondary history of churches in Seneca County mentioned "extensive repairs" being made on the chapel in 1857.¹⁴⁶ A local newspaper carried the following notice, placed by the chapel's minister, Reverend J.A. Swallow: "The Wesleyan Church in this place has been thoroughly repaired, and will Providence permitting, be re-opened for Divine Worship next Sabbath August 16th. The Services will be conducted in the morning by Rev. G. Pegler of Williamson. Afternoon and evening by Rev. H.B. Knight of Syracuse. Collections will be taken up at the close of each service to defray expenses."¹⁴⁷ The fact that the chapel had to be closed, and that guest ministers were brought in to preach at its reopening suggests that the repairs were major.

Unfortunately, little more is known of these repairs. The congregation's pastor, Reverend J.A. Swallow, was in charge of the receipts and accounts of "refitting the meeting house," but by September 1858 he had burned all the accounts. The receipts burned may have been for the 1857 repairs, or for possible subsequent repairs in 1858.¹⁴⁸

Most other repairs mentioned in the church records were minor. The chapel trustees authorized several types of work done on the chapel, including repairing windows, lowering the pulpit steps, lowering the platform in the gallery, and repairing the gas lights. Most of this work seems to have been done by the congregation members themselves. Paint was purchased as well as glass and putty. Other minor upkeep included

145. *Ibid.*, entry dated September 10, 1857.

146. Manual of Churches, p. 172.

147. American Reveille, August 15, 1857.

148. First Wesleyan Methodist Church Records, "Book No. 2," entry dated May 31, 1858; *Ibid.*, September 6, 1858. The church members "most heartily disapproved" of Swallow's action.

whitewashing and repairing stoves. (See Appendix A for details and dates of minor repairs on the chapel interior.)

The trustees discussed the "subject of repairs and remodelling of the Church and also the Sabbath school interest" in April 1868.¹⁴⁹ The nature of repairs needed or the remodelling were not provided. The subject came up again in August 1868 when the trustees were asked "to repair & otherwise improve this House of Worship, at an expense or outlay not exceeding \$4000. . . ." The money was to be raised by voluntary subscription for the preservation of the building and the fence and that no other repairs or improvements be made at present."¹⁵⁰

The discord in the congregation over the Congregationalist split probably precluded any repairs from being made. More than a year later efforts were started to raise a subscription of \$10,000 to repair the "House of Worship." In December 1869 a committee of three was chosen to circulate the subscription.¹⁵¹ In January 1870 Charles G. Corwin was added to the "Repair Committee." Two months later Joseph Metcalf motioned to appoint a "Building Committee," but the motion was deferred two weeks. The decision was soon made to build a new church on the corner of Clinton and Fall streets, rather than repair the chapel.¹⁵²

Selling Portion of Chapel Lot

In September 1857 the chapel trustees took action to sell a part of the chapel lot by appointing a committee of two, supposedly to look into

149. First Wesleyan Methodist Church Records, "Book No. 1," entry dated April 10, 1868.

150. First Wesleyan Methodist Church Records, "Book No. 3," entry dated August 3, 1868.

151. Ibid., entry dated December 7, 1869; Ibid., December 13, 1869.

152. Ibid., entry dated January 3, 1870; Ibid., March 7, 1870.

the matter.¹⁵³ This matter was not mentioned again until May 1863. The trustees were then instructed to consummate a sale of the "North portion of the Church lot, now enclosed with lot owned by Dr [Chauncey B.] Howe, to him, he having re-desired such sale."¹⁵⁴ Nothing more is known about this transaction. The only sale known is of the strip in the rear of the chapel/opera house sold by Angeline and Charles Chamberlain Johnson to Emmett J. Ryan in 1891.¹⁵⁵

Activities in the Chapel

Many different types of activities occurred within the walls of the Wesleyan Chapel. These ranged from visiting pastors delivering sermons and regular chapel activities such as marriages and baptisms, to political meetings, abolition and temperance lectures, and the 1848 Women's Rights Convention. Many well-known nineteenth century reformers presided over gatherings in the chapel, whose congregation remained receptive to the flow of information and ideas.

A remembrance of one revival probably held in the 1850s in the Wesleyan Chapel was offered by local resident Samuel Kline:

One winter there was a "protracted meeting" in progress in one of the village churches--I think it was the old Wesleyan Methodist. These meetings were largely attended, and among others who gathered there nightly, could be seen an occasional group of the canal boatmen. For them it was about the only place they could go for a break in the dull quiet of the long winter nights.

One night when more than usual interest had been manifested, and the service prolonged to a late hour, one of them, youthful in years, but evidently old in the ways of the world, was seen

153. First Wesleyan Methodist Church Records, "Book No. 1," entry dated September 10, 1857.

154. First Wesleyan Methodist Church Records, "Book No. 2," entry dated May 4, 1863.

155. Deed Book 109, p. 339, September 19, 1891, SCCW.

sitting alone in one of the back pews after the services had closed and the assembled worshippers were departing for their homes. That he was from the canal with the aura of the mule stables emanating from his person was plainly evident, his specialty being a position at the business end of a towing line speeding up the motive power.

The pastor observing him, bowed seemingly in deepest contrition drew near and gently laying a hand on the young man's head, spoke some kindly and encouraging words, assuring him of the interest he felt in his conversion, and other talk along that line. It transpired however that the boy had been asleep, and the sudden arousal confused him, and looking about at the vacant seats and the good man standing over him still interested in the welfare of his soul, he blurted out half crying and rubbing his eyes "I feel like h--, where's Jim?" Meaning his companion whom it seems had already departed.

The field didn't appear very fruitful for it was apparent the young man was not seeking the consolation of Israel, and no further efforts were made to bring him into the fold.

I wish to add, by the way, that I do not vouch for this story of the boy and his outbreak, I simply give it as I heard it repeated at the time.¹⁵⁶

Soon after the Wesleyan Methodist Chapel was completed the trustees resolved the "House of Worship" should not be opened for the "purpose of Speaking or preaching in favor of elevating to Power either of the political parties of the Country."¹⁵⁷ Yet in March 1845 this resolution was repealed. Also repealed was a previously passed resolution that the pulpit slips in the chapel should never be sold or rented.¹⁵⁸ Political meetings were held with some frequency throughout the years in the chapel. By 1855 the trustees felt that opening the chapel to "Mass Meetings" was accompanied by a certain "amount of trouble," and they decided to begin charging \$5.00 for the use of the building.¹⁵⁹

156. Kline, "Recollections of Seneca Falls."

157. Wesleyan Methodist Church Records, "Book No. 1," entry dated January 14, 1844.

158. Ibid, entry dated March 27, 1845.

159. Ibid., entry dated April 16, 1855.

Mary Sherwood Bull wrote that such reformers and abolitionists as Frederick Douglass, Charles Lenox Remond, William Lloyd Garrison, Frances Gage and Elizabeth Oakes Smith spoke in the chapel during the Wesleyan Methodist years.¹⁶⁰ Elizabeth Cady Stanton returned in 1855 to speak in the chapel on the subject of "Common Schools." The local newspaper reported the lecture was "largely attended, and gave general satisfaction. Mrs. Stanton is a pleasant speaker, and handled her subject . . . in a masterly manner."¹⁶¹

During the years of political unrest preceding the Civil War the Wesleyan Chapel hosted several discussions of current interest. In 1849 fugitive slave Henry Bibb arrived in Seneca Falls to speak against slavery. He spoke first in the Methodist Episcopal Church on Sunday evening, January 19, but the meeting was adjourned to the "Great Light House of Seneca Falls, known as the Wesleyan Chapel, or Anti-Slavery Depot. . . ."¹⁶² Bibb spoke for two hours on the degradation of slavery before the meeting adjourned "to meet again on Sabbath evening. . . ." According to the chapel's pastor, Saron Phillips, "our large meeting-house was filled and many were unable to get seats, . . ."¹⁶³

In May 1855 Reverend Antoinette L. Brown spoke in the chapel on the controversial elections in Kansas Territory. Her lecture was "well delivered" and "very well attended considering the inclement state of the weather at the time."¹⁶⁴ In September 1856 several Republican party meetings were held, with Frederick Douglass and others sallying forth in

160. Reigel, "'Woman's Rights,'" 45, 51. Biographies of all these reformers can be found in Dictionary of American Biography.

161. American Reveille, March 10, 1855.

162. True Wesleyan, February 10, 1849.

163. Ibid. The newspaper gave the pastor's name as "Sam'l Phillips."

164. American Reveille, May 26, 1855.

support of presidential candidate John C. Fremont.¹⁶⁵ Douglass was described in the American Reveille as possessing "considerable talent as a speaker, but it is conclusive that he has been sadly over-rated, and that he lacks moral honesty, else he would not support a man whose whole past career has been spent in antagonism to Freedom."¹⁶⁶ The paper latter printed its disfavor of those who denounced Millard Fillmore from the "'Sacred Altar' of the Wesleyan Church, [and who] seek to influence the minds of the people to vote for the Popish, Janus-faced candidate of the Black Republican disunion party."¹⁶⁷

Other ministers were sometimes invited to speak to the congregation, or to conduct other business. In March 1860 the Reverend Mr. Buck, pastor of the Methodist Episcopal Church in Geneva, New York, was invited to lecture on temperance in the chapel. Because of political reasons focusing on allegations that Reverend Buck was not an abolitionist, the Wesleyan Methodist trustees refused Reverend Buck the opportunity of lecturing. The American Reveille remarked:

We do not know who the trustees of the Church are, neither do we care; it is enough for us to realize that their intolerance, bigotry and proscription, manifested on this occasion, is disgraceful to themselves and equally so to the good name of our village. Perhaps this may be considered a christian transaction, or it may be that the trustees are getting a little more exclusive than they were a few years ago, when their doors were thrown open for exhibitions of nearly every kind--negro shows and political meetings not excepted.¹⁶⁸

In the next month, April 1860, the trustees were instructed to refuse all "unorthodox Ministers" the use of the chapel, except for funerals, and

165. Ibid., September 27, 1856. The newspaper viciously attacked both Douglass and the Wesleyan Church for supporting and providing the pulpit to the Republican party. It accused local Republicans of being in a "desperate condition," and after failing to "procure a respectable white man to address them, they at last advertised Fred Douglass. . . ."

166. Ibid.

167. Ibid., October 18, 1856.

168. Ibid., March 17, 1860.

not even then unless they had no other place of worship.¹⁶⁹ In March 1870 the Wesleyans offered the chapel's use to the Free Methodists for a quarterly meeting in April.¹⁷⁰ Not only did the Wesleyans offer their chapel to others, but at least once, in 1862, the Wesleyans held a "Union Meeting" with the Baptists and Methodists in Seneca Falls for Thanksgiving services at the Baptist church.¹⁷¹

Other Wesleyan Methodist church business occurred in the chapel as well. Quarterly Meeting with "Love Feast" and the Lord's Supper was held in October 1862. Quarterly Meeting in August 1869 was held at the Methodist Episcopal Church because of the chapel controversy that year. The Rochester Conference of the Wesleyan Methodist Church held sessions at the chapel several years.¹⁷²

The congregation sometimes decorated a Christmas tree and charged adults \$.10 admittance on Christmas Eve.¹⁷³ The Christmas tree, however, was primarily for the enjoyment of the Sabbath school children, who received presents taken from the tree. The Sabbath school engaged in other activities as well, such as holding picnics "at the Lake," or "in a grove near the residence of Mr. Julius Bull." They also went on sleigh rides.¹⁷⁴

169. First Wesleyan Methodist Church Records, "Book No. 2," entry dated April 9, 1860.

170. First Wesleyan Methodist Church Records, "Book No. 3," entry dated March 7, 1870.

171. Reveille, November 22, 1862.

172. Reveille, October 25, 1862; Ibid., August 27, 1869; American Reveille, April 28, 1860; Reveille, September 13, 1867; Ibid., April 15, 1870; Ibid., May 6, 1870; American Wesleyan, January 5, 1870.

173. First Wesleyan Methodist Church Records, "Book No. 3," entry dated December 3, 1866; Reveille, December 20, 1867.

174. Reveille, December 31, 1859, Ibid., September 2, 1865; Ibid., May 21, 1869; Ibid., March 4, 1870.

Indications of the coming discord within the congregation can be seen in April 1869 when the trustees resolved "That this Church Edifice shall neither be occupied, used or opened for any other purpose than such as it has been used for, for some time past, as well as it is at present used for, unless it is done with the consent of a Majority of the Board of Trustees, and with the approbation of the Minister in charge."¹⁷⁵ If this resolution were violated, the trustees president and secretary were authorized to commence legal proceedings against the violators. (See Appendix C for a chronology of events held in the Wesleyan Chapel.)

The Wesleyan Chapel housed a liberal congregation throughout the years of its use. The Wesleyan Methodists remained receptive to open thinking and the exchange of ideas. As a result, the chapel was host to varied reform and political meetings. The Wesleyans weathered the severe dissention during 1868-1869 over the issues of secret societies and church hierarchy. They managed to essentially start over in terms of membership, and proceeded to build themselves a new church. The plain brick chapel, a haven for temperance speakers, antislavery lecturers and the young Elizabeth Cady Stanton, was soon converted into a public hall. The Wesleyan Methodists could not have known their liberality in giving reformers the opportunity to speak from the chapel pulpit would have a profound effect. Their action provided the setting for the founding of the American women's rights movement in July 1848.

175. First Wesleyan Methodist Church Records, "Book No. 1," entry dated April 6, 1869.

CHAPTER II: 1848 WOMEN'S RIGHTS CONVENTION

Elizabeth Cady Stanton was the dominating force behind the women's rights convention held in July 1848 in the Wesleyan Methodist Church. She and four other women--Lucretia Mott, Martha Wright, Mary Ann McClintock, and Jane Hunt--made a determination to try to change women's status in law and in society. (See Appendix D for brief biographies of these five women.) Their initial efforts had nation- and world-wide repercussions which still affect many aspects of modern society. The organized movement for across-the-board reform for "sex equality" began when these women declared their equality with men.

Seneca Falls in 1848

The environment of Seneca Falls was a factor in the holding of the convention. The mill village was situated in the "Burned-over District" of central New York, an area which had experienced many religious revivals, and reform movements.¹

1. Seneca Falls is located in Seneca County, formed from Cayuga County in 1804. The county's geography is diversified, as the land rises gradually from two of the Finger Lakes, Seneca and Cayuga, and contains hills and valleys of scenic beauty. In 1843 the county's soil was mostly "calcareous loam and mould, well adapted to the culture of grain and grass; fruit also flourishes and comes to great perfection." Across the northern section of the county flows the Seneca River, paralleled in 1843 by the Cayuga and Seneca Canal, and the Auburn and Rochester Railroad, both passing through the village of Seneca Falls. The village was incorporated in 1831 and by 1843 contained 3,000 inhabitants and 400 dwelling houses. Churches existing that year in the village included one Presbyterian, one Episcopal, one Baptist, one Methodist and one Roman Catholic. Industries included four hotels and taverns, 20 dry goods and other stores, one cotton factory, eight flouring mills containing 27 run of stones, five saw mills, two plaster mills, one distillery, two iron foundries, two pump manufactories, one sash machine, one paper mill, one axe factory, one cloth dressing works, one tannery and a boat yard. Large quantities of plaster or gypsum, was ground and distributed to a (Continued)

The town was also located near the Erie Canal, which carried not only many immigrants and travelers, but ideas as well. An 1843 description of Seneca Falls, written during the Wesleyan Chapel's construction, testifies to this movement:

This place is a village of considerable importance; the Seneca river passing through it, affords extensive water privileges, which seem to be well occupied by mills, factories, &c., and furnish employment for a large number of persons. The number of inhabitants, according to the census of 1840 is 3000; and its being in the vicinity of the beautiful scenery on the Seneca and Cayuga lakes, and the canal and railroad passing by, we are continually enlivened by the arrival and departure of the packets and cars, and are relieved from² the dull monotony that is sometimes found in a country village.

The canal has been called a "psychic highway" along which New England thought moved into the west.³

In the 1840s both Seneca Falls and Waterloo were changing from being agricultural, transportation and milling towns to being industrial

1. (Cont.) national market. The village was situated on both sides of the outlet of Seneca Lake, and the water power provided by the descent from Seneca Lake to Cayuga Lake, a distance of 12 miles at 75 feet, ran the village's mills. At Seneca Falls the descent was 40 feet within the distance of one mile. Five locks were located in the Cayuga and Seneca Canal, which joined the Erie Canal at Montezuma, New York. John Disturnell, compiler, A Gazetteer of the State of New York, (Albany, New York: C. Van Benthuysen & Co., 1843), pp. 24-25.

2. True Wesleyan, July 22, 1843.

3. Keith E. Melder, Beginnings of Sisterhood The American Woman's Rights Movement 1800-1850 (New York: Schocken Books, 1977), p. 146; This thesis is promoted in Whitney R. Cross, The Burned-Over District The Social and Intellectual History of Enthusiastic Religion in Western New York 1800-1850 (New York: Harper & Row Publishers, 1950). Cross stated that people extraordinarily given to unusual religious beliefs lived along the "psychic highway." They were "devoted to crusades aimed at the perfection of mankind and the attainment of millennial happiness." The term "Burned-over" or "Burnt" district refers to the analogy between forest fires and fires of the spirit. The evangelist Charles Grandison Finney applied the term to the region. The Erie Canal, completed in 1825, aided economic development of the region. Its completion also marked the beginning of major, significant religious enthusiasms. *Ibid.*, pp. 3, 55-56.

towns. Factory-type manufacturing was accompanied by the arrival of the railroad, which in turn, changed the pace of life in the towns. Social disruption occurred, as immigrants moved in and as former home and farm family production was replaced by factory work. Major shifts occurred in the way people worked, for they moved from the farm to the factory. Industrialization wrought major change in family and social life, as people relocated, broke family ties and lost support networks.⁴

Religious and reform movements in Seneca Falls predominated in 1842. Followers of William Miller, the Millerites, left their churches to prepare for the second coming of Jesus. The Methodists, as has been stated, split over the slavery question, and the Wesleyans built their chapel in 1843. Most dramatic were the temperance and antislavery activities. Seneca Falls voted itself dry in 1842. The presence of Abby Kelley in Seneca Falls brought home the question of abolition. In August 1843 she toured the country for the American Anti-Slavery Society, under the guidance of William Lloyd Garrison, a Boston-based abolitionist. Kelley attracted much attention because she accused northern Christians of participating in the slavery system because they belonged to pro-slavery churches, and because she addressed mixed (male and female) audiences in public places. No church in Seneca Falls offered her a speaking place, so she spoke in Ansel Bascom's backyard. After Kelley spoke, a local resident, Rhoda Bement, was excommunicated from the First Presbyterian Church of Seneca Falls for attending Kelley's lecture, for attempting to bring the abolition question before the congregation and for being a female who challenged the male hierarchy of the church.⁵

4. Judith Wellman, "The Mystery of the Seneca Falls Women's Rights Convention: Who Came and Why?" May 31, 1985 (Typescript), pp. 13-22. See chapter I of U.S. Department of the Interior, National Park Service, "Special History Study, Women's Rights National Historical Park, New York," prepared by Sandra S. Weber, Denver Service Center, Denver, Colorado, 1985.

5. Wellman, "The Mystery of the Seneca Falls Women's Rights Convention," pp. 24-26; Glenn C. Altschuler and Jan M. Saltzgeber, (Continued)

The timing of the Seneca Falls convention is significant in terms of national and world events in 1848. The French uprising of February 22, 1848, and other European revolutions brought hope for social change. A presidential election in the United States loomed ahead. The growth of the Free-Soil Party brought emphasis to political action. Realignment of political allegiances occurred with the Texas annexation and the Mexican War. The "barnburners," free-soil New York Democrats, left their national party convention in May 1848 and refused to support the ticket. "Freemen" of Seneca Falls, whether abolitionists, barnburner Democrats or Whigs, met in the Wesleyan Chapel in June 1848 to discuss their discontent over the presidential nominees, neither of which were abolitionists.⁶

The three editors of the History of Woman Suffrage, one of whom was Elizabeth Cady Stanton, acknowledged these national and world political influences:

5. (Cont.) Revivalism, Social Conscience and Community in the Burned-Over District The Trial of Rhoda Bement (Ithaca: Cornell University Press, 1983), pp. 89-140. The Altschuler and Saltzgeber text provides a thorough discussion of the Bement trial, its meaning and significance. Ansel Bascom was a prominent Seneca Falls attorney, businessman and politician who often promoted social reforms. He served as the first president of the village of Seneca Falls, helped develop the village's south side business district, and, as a member of the New York legislature in 1847, aided in the passage of the married women's property act, granting women the right to own property. He was born in 1802 and died in 1862, leaving six children, including Mary Sherwood Bascom Bull. Abby Kelley was an abolitionist who made her first public speech before a "mixed" audience in 1838. She was a well-known lecturer who resigned from the Society of Friends in 1841 because she considered their stand on slavery to be weak. She was married to New England abolitionist Stephen S. Foster, and they often traveled together espousing temperance, feminism and other causes.

6. Ross Evans Paulson, Women's Suffrage and Prohibition: A Comparative Study of Equality and Social Control (Glenview, Illinois: Scott, Foresman and Company, 1973), p. 37; Judith Wellman, "Women's Rights, Free Soil, and Quakerism: The Seneca Falls Women's Rights Convention," Paper Delivered at SHEAR Conference July 1981, (Typescript), pp. 26-27.

In gathering up the threads of history in the last century, and weaving its facts and philosophy together, one can trace the liberal social ideas, growing out of the political and religious revolutions in France, Germany, Italy, and America; and their tendency to substitute for the divine right of kings, priests, and orders of nobility, the higher and broader one of individual conscience and judgment in all matters pertaining to this life and that which is to come. It is not surprising that in so marked a transition period from the old to the new, as seen in the eighteenth century, that women, trained to think and write and speak, should have discovered that they, too, had some share in the newborn liberties suddenly announced to the world. That the radical political theories, propagated in different countries, made their legitimate impress on their minds of women of the highest⁷ culture, is clearly proved by their writings and conversation.

An additional influence was the religious furor occurring almost at the same time in Waterloo. The Junius Monthly Meeting of Friends, a member of the Framington Quarterly Meeting, and of the Genesee Yearly Meeting (Hicksite) suffered from disagreements among members over the question of slavery. The antislavery activities of many Quakers offended more conservative members, who did not want antislavery doctrine preached in Quaker meetings. Questions of authority in the meetings also figured into the conflict, with the result of 200 liberal Friends leaving the meeting in June 1848. Thomas McClintock, a member of the Junius Monthly Meeting, authored a statement describing the splinter group's proposed form of government. Along with his wife Mary Ann, his son and daughters, Thomas McClintock kept active in the abolitionist campaign. Progressive Friends held annual meetings which attracted many advocates of different reforms--including abolitionists, temperance workers and advocates for women's rights.⁸

7. Elizabeth Cady Stanton, Susan B. Anthony, and Matilda Joslyn Gage, eds., History of Woman Suffrage, 6 vols. (Rochester, New York: Susan B. Anthony, 1889; reprint ed., New York: Source Book Press, 1970), 1:50. Hereafter cited as HWS.

8. Wellman, "Women's Rights, Free Soil, and Quakerism," pp. 28-31. For more information on this split and the Progressive Friends, see: A. Day Bradley, "Progressive Friends in Michigan and New York," Quaker History 52 (Autumn 1963): 95-103 and Allen C. Thomas, "Congregational or Progressive Friends A Forgotten Episode in Quaker History," Bulletin of Friends' Historical Society 10 (November 1920): 21-32.

These events account for some of the interest in the women's rights convention which subsequently took place. Changes in the economy and transportation systems in Seneca Falls brought new people and new ideas. Political, religious and societal forces brought together networks of reformers who traveled, spoke, published and gained recruits; all the while challenging accepted societal norms. They challenged the slavery system, the dictates of religious hierarchies, and eventually, the status of women in society. Some of the same people who protested the 1848 presidential nominations, who broke away from the conservative Quaker meeting and Methodist church, and who suffered physical and verbal attacks while preaching abolition, also took interest and leadership roles in the 1848 Women's Rights Convention in the Wesleyan Chapel in Seneca Falls.

The Convention Organizers' Previous Reform Efforts

Elizabeth Cady Stanton and her friends were not novitiates into the world of reform. The women's previous experience played a key role in the background of the first women's rights convention, and it was Stanton who brought together all the political and religious people who soon addressed the rights of women. She had ties to the free-soilers, abolitionists and the Quakers who attended the women's rights convention and signed the Declaration of Sentiments.

Stanton wrote the decision to hold a women's rights convention was made on the streets of London. As a bride on her honeymoon, she accompanied her husband Henry Brewster Stanton to the World Anti-Slavery Convention, held in June 1840. Henry was serving as a delegate from the American and Foreign Anti-Slavery Society.⁹ Here

9. A month before the convention in London the American Anti-Slavery Society split in two. One group wanted more involvement in the political process as a way to end slavery. They were not interested in pursuing any other types of reform, rather, all focus was to be placed on abolition. It was this group, the American and Foreign Anti-Slavery (Continued)

Elizabeth Cady Stanton met Lucretia Mott for the first time. She later wrote, "The acquaintance of Lucretia Mott, who was a broad, liberal thinker on politics, religion, and all questions of reform, opened to me a new world of thought. As we walked about to see the sights of London, I embraced every opportunity to talk with her."¹⁰ An internationally known abolitionist, Hicksite Quaker Lucretia Mott helped organize the American Anti-Slavery Society and the Philadelphia Female Anti-Slavery Society in 1833.¹¹

The 1840 convention is best known not in the history of the abolition movement, but in the history of the women's rights movement. Elizabeth Cady Stanton stated, "The movement for woman's suffrage, both in England and America, may be dated from this World's Anti-Slavery Convention."¹² This notoriety was gained when a majority of the convention delegates, both British and American, refused to recognize

9. (Cont.) Society, which sent Henry B. Stanton as one of its two delegates. In opposition to these political abolitionists were those who believed that political activity degraded the reform, and who insisted on pursuing other reforms, such as non-resistance and women's rights. This second group retained control of the American Anti-Slavery Society and sent four delegates to the London conference: William Lloyd Garrison, Nathaniel P. Rogers, Charles Lenox Remond and Lucretia Mott. Wellman, "Women's Rights, Free Soil, and Quakerism," pp. 15-17.

10. Theodore Stanton and Harriot Stanton Blatch, eds., Elizabeth Cady Stanton as Revealed in Her Letters Diary and Reminiscences, 2 vols. (New York: Harper & Brothers Publishers, 1922), 1: 79-80.

11. For more information concerning women's efforts in the abolition movement, see: Gerda Lerner, The Majority Finds Its Past Placing Women in History (New York: Oxford University Press, 1979), chapter 8, "The Political Activities of Antislavery Women"; and Judith Wellman, "Women and Radical Reform in Antebellum Upstate New York: A Profile of Grassroots Female Abolitionists," in Clio Was a Woman: Studies in the History of American Women, eds. Mabel E. Deutch and Virginia C. Purdy (Washington, D.C.: Howard University Press, 1980), pp. 113-127. Henry B. Stanton's Random Recollections, (New York: Harper & Brothers, 1887) contains information on both abolitionists and the 1840 convention in London. See chapters VIII and IX.

12. HWS, 1: 62.

and seat the American women delegates. Most of the men believed that the convention should focus on ending slavery, and should not address the "woman question." The women had to sit behind a curtain and were not allowed to participate in the proceedings. The exclusion, however, only served to bring the issue to the world's notice.¹³

After the convention adjourned Stanton and Mott strolled "arm in arm" down Great Queen Street and talked about the day's events. According to Stanton, ". . . we resolved to hold a convention as soon as we returned home, and form a society to advocate the rights of women."¹⁴ Years passed, however, before the convention took place because of Stanton's increasing domestic and motherhood duties, and Mott's continued abolition work.

Between 1843 and 1847 Stanton lived in Boston where she was in frequent contact with radical abolitionists and other progressive thinkers.

13. Several secondary and primary sources, including Lucretia Mott's diary, provide the details of the convention proceedings. See: Frederick B. Tolles, ed., Slavery and 'The Woman Question' Lucretia Mott's Diary of Her Visit to Great Britain to Attend the World's Anti-Slavery Convention of 1840 (Haverford, Pennsylvania: Friends' Historical Society and London: Friends' Historical Society Supplement No. 23, 1952), 1-11, 20-44; Douglas H. Maynard, "The World's Anti-Slavery Convention of 1840," Mississippi Valley Historical Review 47 (1960): 452-471; HWS, 1: 50-62; and Anna Davis Hallowell, ed., James and Lucretia Mott Life and Letters (Boston: Houghton, Mifflin and Company, 1884), pp. 151-160. Stanton had nothing but high praise for William Lloyd Garrison, who arrived at the convention too late to participate in the debate over the women's admission. He therefore declined to take his seat on the convention floor, and sat with the women as a "silent spectator in the gallery" for the convention's duration of 10 days. Stanton wrote, "Brave, noble Garrison! May this one act keep his memory fresh forever in the hearts of his countrywomen!" HWS, 1:61.

14. Stanton and Blatch, eds., Elizabeth Cady Stanton as Revealed, 1: 79; HWS, 1: 61. A discrepancy exists concerning the date of this conversation between Mott and Stanton. Mott wrote to Stanton in 1855 and remembered the conversation as having occurred on the streets of Boston in 1841. Stanton and Blatch, eds., Elizabeth Cady Stanton as Revealed, 11: 18, note 3. The History of Woman Suffrage stated that two conversations took place--in London and in Boston. HWS, 1: 68. It is not known whether Stanton was in Boston in 1841.

She became familiar with the ideas of Maria Weston Chapman, Abby Kelley and Margaret Fuller.¹⁵

Elizabeth Cady Stanton's "General Discontent"

Elizabeth Cady Stanton and her family moved to Seneca Falls in 1847. Stanton took up housekeeping while her husband pursued a law practice. Small-town life quickly overwhelmed her. Nothing in Seneca Falls could compare with the excitement of Boston, and Stanton was soon depressed over the lack of mental and social stimulation.¹⁶ She later reminisced:

In Seneca Falls my life was comparatively solitary, and the change from Boston was somewhat depressing. There, all my immediate friends were reformers, I had near neighbors, a new house with all the modern conveniences, and well-trained servants. Here, our residence was on the outskirts of the town, roads very often muddy and no sidewalks most of the way, Mr. Stanton was frequently from home, I had poor servants, and an increasing number of children. To keep a house and grounds in good order, purchase every article for daily use, keep the wardrobes of half a dozen human beings in proper trim, take the children to dentists, shoemakers, and different schools, or find teachers at home, altogether made sufficient work to keep one brain busy, as well as all the hands I could impress into service. Then, too, the novelty of housekeeping had passed away, and much that was once attractive in domestic life was now irksome.¹⁷

15. Melder, Beginnings of Sisterhood, p. 145. Maria Weston Chapman was an abolitionist who helped organize the Boston Female Anti-Slavery Society in 1832. She wrote several abolitionist tracts and occasionally edited several others, including William Lloyd Garrison's Liberator. Margaret Fuller was a brilliant conversationalist who held a series of public "conversations" in Boston for the education of women from 1839-1844. She edited the Transcendentalist Dial, and was the literary critic for Horace Greeley's New York Tribune. In 1845 Margaret Fuller published the classic feminist work, Woman in the Nineteenth Century.

16. Melder, Beginnings of Sisterhood, p. 146.

17. Stanton and Blatch, eds., Elizabeth Cady Stanton as Revealed, I: 142-143.

Stanton also was awakened to the living conditions of some of her poor Irish immigrant neighbors. She was often called upon to settle disputes and stop domestic quarrels between husbands and wives. She witnessed firsthand the problems, in her view, of "unwelcome motherhood" steeped in ignorance, poverty and vice, where women and children feared the passions of drunken fathers.¹⁸ All these influences coalesced in Stanton's mind, enough to spur her to change not only her life, but the lives of other women. She later wrote how the idea of a convention began to form:

I now fully understand the practical difficulties most women had to contend with in the isolated household, and the impossibility of woman's best development if in contact, the chief part of her life, with servants and children. . . . The general discontent I felt with woman's portion as wife, mother, housekeeper, physician, and spiritual guide, the chaotic conditions into which everything fell without her constant supervision, and the wearied, anxious look of the majority of women impressed me with a strong feeling that some active measures should be taken to remedy the wrongs of society in general, and of women in particular. My experience at the World's Antislavery Convention, all I had read of the legal status of women and the oppression I saw everywhere, together swept across my soul, intensified now by many personal experiences. It seemed as if all the elements had conspired to impel me to some onward step. I could not see what to do or where to begin--¹⁹ my only thought was a public meeting for protest and discussion.

While in this state of mind Stanton received an invitation to spend a day with Lucretia Mott, who was in the area attending the Yearly Meeting of Friends in western New York and visiting her sister, Martha Wright, in nearby Auburn, New York. At the home of Richard and Jane Hunt in Waterloo, Stanton not only met with Mott, but with "several members of different families of Friends, earnest, thoughtful women."²⁰ Stanton

18. Ibid., I: 143-144.

19. Ibid., I: 144-145.

20. Ibid., I: 145. In History of Woman Suffrage, Stanton mentioned only Mott, Wright and Mary Ann McClintock as being present at this meeting, but added Jane Hunt's name in her reminiscences. HWS, I: 67; Stanton and Blatch, eds., Elizabeth Cady Stanton as Revealed, I: 146; (Continued)

"poured out the torrent of my long-accumulating discontent with such vehemence and indignation that I stirred myself, as well as the rest of the party, to do and dare anything."²¹ The women--Stanton, Wright, Mott, Jane Hunt and Mary Ann McClintock--proceeded to insert a notice in the local newspaper, calling for a convention wherein women's rights issues would be discussed. Years of reform experience were behind them, yet the women soon discovered that the call for "equality" was only the beginning of a protracted philosophical, social, legal and economic battle. (See illustration 12 of the five women who organized the convention.)

The Convention Proceedings

WOMAN'S RIGHTS CONVENTION--A Convention to discuss the social, civil, and religious condition and rights of woman, will be held in the Wesleyan Chapel, at Seneca Falls, N.Y., on Wednesday and Thursday, the 19th and 20th of July, current; commencing at 10 o'clock AM. During the first day the meeting will be exclusively for women, who are earnestly invited to attend. The public generally are invited to be present on the second day, when Lucretia Mott, of Philadelphia,²² and other ladies and gentlemen, will address the convention.

20. (Cont.) Stanton does not provide the day or date of this meeting, but it has been thought to have occurred on Thursday, July 13. John E. Becker, A History of the Village of Waterloo New York and Thesaurus of Related Facts (Waterloo, New York: Waterloo Library and Historical Society, 1949), p. 151. However, the first notice of the convention appeared in a local newspaper on July 11 and not the 14th; thus the current belief is the meeting took place on Sunday, July 9.

21. Stanton and Blatch, eds., Elizabeth Cady Stanton as Revealed, I: 145.

22. HWS, I: 67; Historians have traditionally used Stanton's reminiscences and the History of Woman Suffrage as standard accounts of the Seneca Falls convention. However, Ross Evans Paulson has written that historians should be careful when using these works. Stanton did not keep a diary until she was 65 years old, and her memoirs were published when she was 80. Discrepancies in dates abound, including the dates of the initial planning for the convention, and the date when she and Lucretia Mott discussed holding the convention. Additionally, Lucy Stone and Henry Blackwell of the American Woman Suffrage Association (Continued)

Jane Hunt, Lucretia Mott, Martha Wright, Elizabeth Cady Stanton and Mary Ann McClintock published this call in the Seneca County Courier, Seneca Falls' semi-weekly journal, on July 11, 1848.²³ The convention notice appeared again in the Seneca County Courier on July 14 and July 18. The notice also appeared in the North Star, published in nearby Rochester by black abolitionist Frederick Douglass. It read:

A Convention to discuss the Social, Civil and Religious Condition and Rights of Woman, will be held in the Wesleyan Chapel at Seneca Falls, New York, on Wednesday and Thursday, the 19th and 20th of July instant.

During the first day, the meetings will be exclusively for women, which are all earnestly invited to attend. The public generally are invited to be present on the second day, when Lucretia Mott, of Philadelphia, and others, both ladies and gentlemen, will address the Convention.²⁴

22. (Cont.) claimed that the Seneca Falls convention was not the first; that one had been held in Akron, Ohio in 1847. Paulson noted that the first volume of History of Woman Suffrage was written from 1876 to 1881 when Stanton's and Susan B. Anthony's National Women Suffrage Association was fighting with the AWSA for influence. The History of Woman Suffrage, therefore, reflected the authors' desires to establish the supremacy of the NWSA. This included promoting the idea that the reform experience of the NWSA's leaders from 1840 to 1848 gave them priority in leading the women's rights movement. Paulson, Women's Suffrage and Prohibition, pp. 33-34, 1. Other secondary accounts of the convention include: Eleanor Flexnor, Century of Struggle: The Woman's Rights Movement in the United States (Cambridge, Massachusetts: Harvard University Press, 1959); Miriam Gurko, The Ladies of Seneca Falls The Birth of the Woman's Rights Movement (New York: Schocken Books, 1974); and Keith Melder's Beginnings of Sisterhood.

23. Stanton's accounts give the first date of publication as July 14 and this has been traditionally accepted in secondary sources. However, the notice first appeared in the Courier on July 11. The women thus had eight days to prepare, instead of the stated five; and the organizational meeting at the Hunts' probably occurred on July 9. Seneca County Courier, July 11, 1848; Wellman, "The Mystery of the Seneca Falls Women's Rights Convention," p. 51.

24. North Star, July 14, 1848. Frederick Douglass was an escaped slave who bought his freedom and became a noted abolitionist, reformer, lecturer and author. He worked for the Massachusetts and New England Anti-Slavery societies, issued the North Star for 17 years, helped recruit the 54th and 55th Massachusetts black regiments, and after the Civil War, became United States minister to Haiti. Douglass remained a supporter of (Continued)

On the following Sunday, after the call was written and before the convention was held, the women met in the parlor of Mary Ann McClintock's home in Waterloo to write documents needed for the planned proceedings. Gathered around a mahogany center table, they wrote a declaration and resolutions. Even though several of these women were experienced writers, they were inexperienced at conducting a convention or in writing convention documents, and Stanton wrote they "felt as helpless and hopeless as if they had been suddenly asked to construct a steam engine."²⁵ They scrutinized male-authored documents generated by past peace, temperance and antislavery conventions, but these seemed, according to Stanton, "too tame and pacific for the inauguration of a rebellion such as the world had never before seen."²⁶ One of the women picked up the 1776 Declaration of Independence, and the decision was made to use the document and modify it by substituting "all men" for "King George." The women wanted to match the Founding Fathers' 18 grievances against the king, so they, with the aid of "several well-disposed men," searched through statute books, church laws and societal customs to complete their list.²⁷ The final document was called a Declaration of Sentiments.

The convention began on Wednesday, July 19, 1848, at 11 o'clock. The women did not know how many people would attend, and Lucretia Mott warned Stanton, "The convention will not be so large as it otherwise might be, owing to the busy time with the farmers, harvest, etc. But it will be a beginning, and we may hope it will be followed in due time by

24. (Cont.) women's suffrage throughout his life. See also: Philip S. Foner, ed., Frederick Douglass on Women's Rights, (Westport, Connecticut: Greenwood Press, 1976.)

25. HWS, I: 68. The date of this meeting probably was Sunday, July 16.

26. Ibid.

27. Ibid., I: 68-69.

one of a more general character."²⁸ The organizers arrived, carrying the declaration, resolutions and several New York statute books, only to find the Wesleyan Chapel locked. A boy was lifted through an open window to unbar the door, and the crowds, which had arrived in carriages and on foot, entered the church.²⁹ Charlotte Woodward attended the convention and described the scene: "At first we travelled quite alone . . . but before we had gone many miles we came on other waggon-loads of women, bound in the same direction. As we reached different cross-roads we saw waggons coming from every part of the county, and long before we reached Seneca Falls we were a procession."³⁰

Even though the first day's meetings were for women only, so many men arrived that a decision was made, after a "hasty council" was held "round the altar," to allow the men to attend. In addition, the women who were to organize the proceedings and lead the discussions were hesitant to do so, and the men took over the organizing chores.³¹

James Mott, dressed in Quaker clothing, assumed the chair. Mary McClintock was appointed secretary and her report of the proceedings

28. Stanton and Blatch, eds., Elizabeth Cady Stanton As Revealed, II: 17-18. Lucretia Mott and her sister Martha Wright stayed at the Stanton residence during the convention. James Mott was feeling "poorly" and as late as three days before the convention, Lucretia believed she and her husband would not be able to attend the proceedings until the second day. Ibid.

29. HWS, I: 69.

30. Gurko, Ladies of Seneca Falls, p. 99. Charlotte Woodward was 19 years old at the time of the convention, and she was the only one of the 100 signers of the Declaration of Sentiments who lived to see the Nineteenth Amendment passed in 1920. Andrew Sinclair, The Better Half The Emancipation of the American Woman (New York: Harper & Row, Publishers, 1965), p. 60.

31. HWS, I: 69.

identified Elizabeth Cady Stanton as beginning the discussions by stating the objectives of the convention.³² Lucretia Mott, who was accustomed to speaking before men, then asked the women to overcome their past training and societal restraints, and to participate in the day's debates. She spoke of the importance of women's education. Elizabeth McClintock, Mary McClintock and Elizabeth Cady Stanton read speeches; Martha Wright read several of her published pieces answering newspaper attacks on "woman's sphere"; and Ansel Bascom spoke about the property bill for married women, which had just passed the New York legislature. Samuel Tillman read aloud statutes which illustrated women's status in the law.³³

Elizabeth Cady Stanton then read the Declaration of Sentiments, and some changes were suggested and adopted.³⁴ At this point a discussion took place concerning the propriety of the men signing the declaration, but a final vote was deferred until the next day. The convention then adjourned until 2:30 o'clock.³⁵

32. [Mary McClintock], Report of the Woman's Rights Convention, Held at Seneca Falls, N.Y., July 19th and 20th, 1848, (Rochester, New York: John Dick, 1848[?]), p. 3. The proceedings of the Seneca Falls convention and the following Rochester convention may also be found in Woman's Rights Conventions Seneca Falls & Rochester 1848, New York: Arno & The New York Times, 1969). Stanton wrote that Lucretia Mott stated the convention's objectives. HWS, I: 69. A convention attendee, Mary Sherwood Bull, offered a description of the principal women:

. . . Mrs. Stanton, stout, short, with her merry eye and expression of great good humor; Lucretia Mott, whose presence then as now commanded respect wherever she might be; Mary Ann McClintoc, a dignified Quaker matron with four daughters around her, two of whom took active part in the proceedings. These ladies, Elizabeth and Mary McClintoc, were beautiful women, with dignified and self-possessed manners not often seen in women brought up as they were in a country town of that day. Riegel, ""Woman's Rights,"" p. 50.

33. Elizabeth Cady Stanton's speech can be found in Ellen Carol DuBois, ed., Elizabeth Cady Stanton Susan B. Anthony Correspondence, Writings, Speeches (New York: Schocken Books, 1981), pp. 27-35. Samuel D. Tillman, lawyer and businessman, was a free-soiler and an abolitionist. He died in Brooklyn, New York.

34. [McClintock], Report, p. 3; HWS, I: 69.

35. [McClintock], Report, pp. 3-4.

When the meeting readjourned the morning session's meeting minutes were read, and Elizabeth Cady Stanton and Lucretia Mott addressed the crowd. The declaration was re-read, a vote was taken on an amendment to the declaration, and papers were circulated to obtain signatures. Eleven convention resolutions were then read. Lucretia Mott followed by reading a humorous article written by her sister, Martha Wright, and Elizabeth McClintock made an address. Mott then delivered a speech about reform in general. The meeting adjourned until 10 o'clock the next day.³⁶

James Mott assumed the chair again on Friday, July 20th. The previous day's minutes were read, Elizabeth Cady Stanton re-read the Declaration of Sentiments, and several people made comments, including Stanton, Lucretia Mott, Ansel Bascom, Stephen E. Woodworth, Thomas and Mary Ann McClintock, Frederick Douglass, Amy Post and Catharine Stebbins. The Declaration of Sentiments was then unanimously adopted. The meeting adjourned until two o'clock.³⁷

Upon reconvening the minutes were read, and each resolution was individually discussed. According to Mary McClintock, "Some, from their self-evident truth, elicited but little remark; others, after some criticism, much debate, and some slight alterations, were finally passed by a large

36. Ibid., pp 4-6.

37. Ibid., pp. 6-7. Stephen E. Woodworth was a Seneca Falls merchant who operated a wholesale and retail dry goods and grocery store at the corner of Ovid and Bayard streets. He possessed abolitionist sentiments and was a Baptist. His sister-in-law, Mary Gilbert, also signed the declaration, and his niece was Grace Woodworth, the noted photographer. Amy Kirby Post (1802-1889) was a Rochester, New York abolitionist who left the Society of Friends over the slavery issue. She was a charter member of the Western New York Anti-Slavery Society. Catharine Fish Stebbins and her husband Giles were Rochester reformers associated with William Lloyd Garrison and the Western New York Anti-Slavery Society.

majority."³⁸ Stanton, however, wrote that all the resolutions passed unanimously, except for the ninth, which elicited considerable debate.³⁹

Elizabeth Cady Stanton was entirely responsible for this resolution, which called for women's elective franchise. She faced opposition for this insertion, even from Lucretia Mott (who "amazed" Stanton by saying "Why, Lizzie, thee will make us ridiculous"). It was feared a call for the elective franchise would defeat the other resolutions and bring the proceedings under attack. Frederick Douglass came to Stanton's aid, arguing for the resolution which finally passed by a "small majority."⁴⁰ After the vote, Lucretia Mott delivered a "forcible speech" and the meeting adjourned until 7:30 o'clock.⁴¹

That evening, Thomas McClintock chaired the meeting. Stanton spoke, as did Thomas McClintock and Lucretia Mott, who offered a final resolution which stated the cause's success depended upon the efforts of both men and women to overcome the discriminations against women by the pulpit and in employment. Mary Ann McClintock delivered a short speech and Frederick Douglass spoke in support of the women's cause. The convention ended with one of Lucretia Mott's "most beautiful and spiritual appeals" which lasted for nearly an hour.⁴²

An eyewitness to the last evening's events, Amelia Bloomer, later wrote a description of the crowd:

38. Ibid., p. 11.

39. HWS, I: 73; Stanton and Blatch, eds., Elizabeth Cady Stanton as Revealed, II: 146.

40. Stanton and Blatch, eds., Elizabeth Cady Stanton as Revealed, II: 146-147; HWS, I: 73.

41. [McClintock], Report, p. 11.

42. Ibid., p. 12.

. . . I was not at the convention, nor within fifteen miles of it, until the last evening, and then was compelled on account of my late arrival, and the immense "crowd" already congregated, to take a seat in the gallery. I can verify Mrs. Stanton's statement of a "crowd" so far as that evening was concerned, whatever may have been the attendance at other sessions of the convention.

Of the more than 300 people who attended the two-day convention, 100 signed their names to the Declaration of Sentiments. Sixty-eight women and 32 men, relatively young, mostly middle-class, associated with abolitionist, temperance, free-soil and Whig-Republican interests, put their names to the document. Seventy percent were from Seneca Falls and Waterloo. Over 20 of the signers belonged to the Society of Friends.⁴⁴

Reaction to the Convention

Press and pulpit reaction to the convention's proceedings came swiftly. According to Stanton:

No words could express our astonishment on finding that what seemed to us so timely, so rational, and so sacred, should be a subject for sarcasm and ridicule to the entire press of the nation. With our Declaration of Rights and Resolutions for a text, it seemed as if every man who could wield a pen prepared a homily on "woman's sphere."⁴⁵

43. Reveille, July 30, 1880.

44. Paulson, Women's Suffrage and Prohibition, p. 36. See also, Judith Wellman, "The Mystery of the Seneca Falls Women's Rights Convention," pp. 65-73. Using census reports, church records, local histories, maps, newspapers, genealogies, letters and assessment records, Judith Wellman has uncovered data on 79 of the 100 signers. Wellman also offered an explanation for the large attendance at the convention. Perhaps the advance notice was longer than thought, and at least 56 Declaration of Sentiments signers, those from Seneca Falls and Waterloo, were previously linked by existing networks--free-soilers, Quakers, families and friends. Wellman, "Women's Rights, Free Soil, and Quakerism," pp. 11-12.

45. Stanton and Blatch, eds., Elizabeth Cady Stanton as Revealed, I: 148.

The 100 signers found themselves the targets for the "jibes and jeers of the nation." The attack was so great that many of the signers withdrew their names and influence from the document, and indeed joined the women's persecutors. Only the antislavery papers defended the proceedings, following the lead of Frederick Douglass' North Star.⁴⁶ Douglass remarked:

The speaking, addresses, and resolutions of this extraordinary meeting, were almost wholly conducted by women, and although they evidently felt themselves in a novel position, it is but simple justice to say, that their whole proceedings were characterized by marked ability and dignity. . . . Our doctrine is, that "Right is of no sex." We therefore bid the women engaged in this movement our humble God speed.⁴⁷

The local Seneca County Courier took a conservative stance, and prophetically commented:

This convention was novel in its character, and the doctrines broached in it are startling to those who are wedded to the present usages and laws of society. The resolutions are of the kind called radical. Some of the speeches were very able--all the exercises were marked by great order and decorum. When the Declaration of Sentiments and Resolutions, shall be printed and circulated, they will provoke much remark. All will be curious to know their nature. Some will regard them with respect--others with disapprobation and contempt.⁴⁸

The paper printed the resolutions on August 4, 1848.⁴⁹

Despite the newspaper attacks, the women were generally pleased with their efforts, and decided to hold a second convention in nearby

46. HWS, I: 73; Stanton and Blatch, eds., Elizabeth Cady Stanton as Revealed, I: 148.

47. North Star, July 28, 1848.

48. Seneca County Courier, July 21, 1848.

49. Ibid., August 4, 1848. For further discussion of the press' editorial response to the convention and Stanton's rebuttals, see Stanton and Blatch, eds., Elizabeth Cady Stanton as Revealed, II: 18-22, and HWS, I: 802-808.

Rochester. Stanton wanted the women's rights movements to follow precedents established by other reforms, to be advocated through more conventions, speakers, publicity and petition drives.⁵⁰ She remarked, "Those who took part in the Convention at Seneca Falls, finding at the end of the two days, there were still so many new points for discussion, and the gift of tongues had been vouchsafed to them, adjourned, to meet in Rochester in two weeks."⁵¹ But Stanton did have some reservations. If she had known of the attacks which followed the Seneca Falls convention, she feared she would have not had the courage to risk holding the meeting. It was only with "fear and trembling" that she consented to the Rochester conference.⁵²

The North Star published an announcement of the convention on July 28, 1848. It read:

A meeting to discuss the rights of women will be held in this city on Wednesday 2d August. The place of meeting will be announced in the city papers. A meeting preliminary to this will be held on the evening of the 1st, in Protection Hall, Stone's Buildings. We are happy to announce that James and

50. Melder, Beginnings, p. 149.

51. HWS, I: 75.

52. Stanton and Blatch, eds., Elizabeth Cady Stanton as Revealed, I: 148. Perhaps Stanton's fears were also based on what was happening at her home. According to her son, Gerrit Smith Stanton:

The Seneca Falls convention woke up all the cranks, long-haired individuals, ismists, both male and female in the State of New York and all roads led to Seneca Falls and the Stanton mansion. . . . The house with its wings had many bedrooms and as Mrs. Stanton was a hospitable hostess [sic] it was just the place for 'advanced thinkers' to gather without being disturbed, express their views while partaking of the Stanton viands by day and calmly reposing in the Stanton beds at night. G. Smith Stanton, "How Aged Housekeeper Gave Her All To Cause of Woman's Suffrage," undated newspaper clipping, Archives Collection: 37, Local Historical Personalities E.C. Stanton, Box 40, Folder 5, SFHS.

Lucretia⁵³Mott, with other persons from abroad, will be present.

The convention was held at the Unitarian Church on North Fitzhugh Street.⁵⁴ Once again at this meeting, the women shied from taking leadership roles. The convention almost fell apart until two women, Amy Post and Rhoda De Garmo, assured the attendees that "by the same power by which they had resolved, declared, discussed, debated, they could also preside at a public meeting, if they would but make the experiment." Abigail Bush assumed the chair and discharged her duties in an "admirable manner."⁵⁵

Debates at this convention focused on women's role in the church, women's work, and problems of working-class women. Elizabeth Cady Stanton read the Declaration of Sentiments adopted at Seneca Falls, hoping that any clergy present would state their opposition, and not keep silent, only to denounce the women on the following Sunday from their pulpits.⁵⁶ Both Stanton and Lucretia Mott approved of the resolutions adopted, but thought them too tame. They wished for "some more stirring declarations."⁵⁷

The year 1850 was a good one for women's rights conventions. A meeting held in Salem, Ohio, addressed Ohio women's grievances, while a

53. North Star, July 28, 1848.

54. Ibid., August 11, 1848.

55. Ibid. Abigail Bush, of Rochester, New York was an active member of the Western New York Anti-Slavery Society.

56. HWS, I: 75-76, 78-80.

57. Ibid., I: 80; For a contemporary account of the Rochester convention proceedings see the North Star, August 11, 1848. The convention is also discussed in Nancy A. Hewitt, Women's Activism and Social Change Rochester, New York 1822-1872 (Ithaca: Cornell University Press, 1984), pp. 130-134. The Rochester convention resolutions can be found in HWS, I: 808-809.

Worcester, Massachusetts, convention was the first to promote a national interest in women's rights. These proceedings followed the typical pattern of reform meetings, including speeches and the appointment of committees on education, vocations, civil and political affairs and social relations. A central committee was formed to schedule additional meetings and serve as an executive body. According to historian Keith Melder, the Worcester convention marked the end of the organizing process of the women's rights movement. In the following decade, the movement became an independent, organized reform crusade, and national conventions were held every year except 1857. Through conventions, publicity, and publications many converts were gained for the cause.⁵⁸

Many of the goals and characteristics adopted by the women's rights movement remained foremost in its agenda on into the twentieth century. These goals were developed during the years preceding the 1848 convention, and the prime push for human rights was obtained from the antislavery movement. Other claims included legal rights, redresses in women's economic situations, demands for equal education, moral equality and the power of personal autonomy. In order to control their own lives women needed the freedom of choice. Corrupted societal custom, and not inferiority, degraded the lives of American women.⁵⁹

58. Melder, Beginnings of Sisterhood, pp. 150-153.

59. *Ibid.*, pp. 154-156. Much has been written concerning the status and activities of women in the nineteenth century, the origins and philosophy of the women's rights movement, the subsequent suffrage campaign and the moral, legal, social and religious ramifications of the women's rights movement on American society. A few of the titles include: Anne Firor Scott and Andrew M. Scott, One Half the People The Fight for Woman Suffrage (Philadelphia, J.B. Lippincott Company, 1975); Mary R. Beard, Woman as Force in History in Traditions and Realities (New York: Octagon Books, 1976); Andrew Sinclair The Better Half The Emancipation of the American Woman (New York: Harper & Row, Publishers, 1965); Eleanor Flexner, Century of Struggle The Woman's Rights Movement in the United States (Cambridge, Massachusetts: Harvard University Press, 1959); Aileen S. Kraditor, ed., Up From the Pedestal Selected Writings in the History of American Feminism (Chicago: Quadrangle Books, Inc., 1968); Norma Basch, In the Eyes of the Law Women, Marriage, and Property in Nineteenth Century New York (Ithaca: (Continued)

The legacy of the 1848 women's rights convention held in the Wesleyan Chapel is that of change. According to Keith Melder:

The struggle for woman's rights was a product of change--the spirit of perfectionism demanding improvement in established institutions and in human individuals, industrialization and modernization, changing the patterns of women's work and elevating their aspirations, and the consciousness among many middle-class women that they as a group had common goals requiring collective action to achieve.⁶⁰

Changes in Seneca Falls--settlement patterns, the influx of immigrants, industrialization, improved transportation--contributed to the general reforming atmosphere. Religious disagreements, resulting in the splits in the Quaker and Methodist churches, also contributed to the atmosphere of change. Another ingredient was the personal discontent of Elizabeth Cady Stanton and her friends. These factors, taken as a whole, fomented a women's rights convention, held in the Wesleyan Chapel, which succeeded in changing people's attitudes toward themselves and others.

59. (Cont.) Cornell University Press, 1982); Ann Douglas, The Feminization of American Culture (New York: Alfred A. Knopf, 1977); Gerda Lerner, The Majority Finds Its Past Placing Women in History, (New York: Oxford University Press, 1979) chapter 2, "The Lady and the Mill Girl: Changes in the Status of Women in the Age of Jackson"; Carroll Smith-Rosenberg, "The Female World of Love and Ritual: Relations between Women in Nineteenth-Century America," Signs: Journal of Women in Culture and Society 1, no. 1 (1975): 1-29; Carroll Smith-Rosenberg, "Beauty, the Beast and the Militant Woman: A Case Study in Sex Roles and Social Stress in Jacksonian America," American Quarterly 23 (1971): 562-584; Ellen Carol DuBois, Feminism and Suffrage The Emergence of an Independent Women's Movement in America (Ithaca: Cornell University Press, 1978).

60. Melder, Beginnings of Sisterhood, p. 158.



CHAPTER III: EVOLUTION OF THE WESLEYAN CHAPEL

The Wesleyan Chapel underwent significant alterations after the Wesleyan Methodists sold it in 1871. The building evolved physically into a structure used for a variety of businesses throughout the next 100 years. Yet for many years the chapel was used for purposes similar to those for which it was originally constructed. Public meetings, temperance lectures, church services and other community actions occurred within the old chapel walls despite drastic changes in the building's physical appearance. Not until the early twentieth century did the character of the building's use totally change. Corresponding physical changes rendered the Wesleyan Chapel unrecognizable, yet not forgotten by groups of women who kept the memory of the 1848 Women's Rights Convention alive over the years.

William Johnson's Hall

Charles G. Corwin purchased the Wesleyan Chapel from the Wesleyan Methodists on October 31, 1871. The Wesleyans continued to hold services in the chapel until January 1872, when they moved into their new church at the other end of the Fall Street block. It is not known how the chapel was used until Corwin sold it later in the year. He only held onto the property until July 1, 1872, when he and his wife Helena sold it to William Johnson for \$5,000.¹

The local Reveille reported on May 3, 1872, that one Albert Jewett, a Seneca Falls merchant, had purchased the "old Wesleyan Church

1. Deed Book 83, p. 277, July 1, 1872, SCCW. The deed description of the property read: ". . . bounded on the north by land of Isaac Desky, East by Mynderse Street, South by Fall Street, and west by land occupied by Washington Race, being fifty four feet front on Fall Street, and in rear being the same premise, conveyed to said Charles G. Corwin by The Trustees of the First Wesleyan Methodist Society of Seneca Falls."

property." On June 21 came the newspaper report that Albert Jewett and William Johnson had purchased the property and had plans underway to remodel the chapel. Despite this newspaper report, which appeared prior to the actual sale, Albert Jewett's name did not appear on the deed between the Corwins and William Johnson.² Perhaps Johnson and Jewett had planned to purchase the property together; for some reason this proposition was not realized, but Johnson went ahead with the purchase. He also proceeded with the remodelling. According to the Reveille, the chapel was to be changed into two stores and a public hall. "The front of the building is to be brought out even with the street, and the roof raised some seven or eight feet. The first floor will be finished off into stores, and the second floor into a hall for public accommodation. Messrs. Adair & Cowin are doing the carpenter work, and Mr. Wm. Van Gorder the masonry."³ The work was almost finished within two months. The Reveille reported: "The old Wesleyan church has been overhauled and remodeled into a fine looking block with two store fronts on Fall

2. Reveille, May 3, 1872; *Ibid.*, June 21, 1872; Deed Book 83, p. 277, July 1, 1872, SCCW. These newspaper articles about the sale were printed before the sale was actually made in July, as entered in the county deed records. Albert Jewett owned the Phoenix Mills on Fall Street, and built the Jewett Block. A biographical sketch stated Jewett "bought the old Wesleyan [sic] church of Mr. Corwin and converted it into an opera house." No evidence of this has been found, except in newspaper accounts; thus Jewett's relationship to William Johnson in developing the Johnson Hall is not known. "Albert Jewett," in Papers read before the Seneca Falls Historical Society Including the History and Centennial Proceedings of The First Presbyterian Church Seneca Falls, N.Y. For the year 1907, p. 39. This article may be found in Seneca Falls Historical Society Papers 1903-1911/12.

3. Reveille, June 21, 1872. The 1862 Seneca Falls directory lists two Van Gorders--James Van Gorder, who lived at 67 State Street and a Van Gorder, mason, at 15 Chapel Street. The 1867 Seneca Falls directory lists James Van Gorder of Seneca Falls, mason. There is no listing for Van Gorder in the 1874 Seneca Falls directory. Elijah Adair and Isaac S. Cowin were carpenters and builders with offices at the corner of Bridge and Water streets. Adair lived at 67 State Street while Cowin lived on Mynderse Street near Jefferson Street. 1862 Seneca Falls Directory, p. 70; 1867 Seneca Falls Directory, p. 205; 1874 Seneca Falls Directory, pp. 25, 41, 113.

street; this we understand, when completed, will be occupied by the Cooperative grocery."⁴

A comparison of 1871, 1873 and 1882 Seneca Falls map details and an 1881 Sanborn map detail confirm this work was done. The shape of the chapel changed from rectangular to having a storefront on the Fall Street end, and a room added to the building's north end. The roof of the storefront end was raised seven or eight feet. (See 1871, 1873 and 1882 Seneca Falls map details, illustrations 11, 14 and 16, and the 1881 Sanborn map detail, illustration 23.) Further discussion of the building's physical appearance appears later in the text.

William Johnson only owned the chapel for a few years, as he died in 1875. (See illustrations 17 and 18 of William Johnson and his residence in Seneca Falls.)⁵

4. Reveille, August 30, 1872.

5. William Johnson was well known throughout New York as a state legislator. Born in December 1821 in Massachusetts, he moved with his parents to Frankfort, New York. At age 14 he studied mechanics and worked as a contractor on public works, a career which brought him to Seneca Falls. From 1849-1856 he built state canals and railroads, and he then entered woolen goods manufacturing. At the Civil War's outbreak, Johnson was a member of the state assembly, but he soon became a recruiter for Seneca County, and organized the 1,200 strong 148th regiment. He served as the regiment's colonel until forced to leave due to ill health. In 1871 he was elected by democrats to serve as state senator in the 26th senatorial district, which included Seneca Falls. He served two terms in the state senate, was on committees for manufactures, canals and militia, and chaired the Tweed investigating committee, which published a report on that scandal. In 1855 he married Angeline Chamberlain, the daughter of Jacob P. Chamberlain. They had five sons, one of whom, Charles Chamberlain, would run the Johnson Hall and opera house, and they lived on Cayuga Street near North Park, in a house since demolished. William Johnson was described as being "highly esteemed for his many personal qualities. He was possessed of a kind and generous nature, a warm social disposition and a frankness that made him a large circle of close personal friends. He was eminently successful in his ventures which was largely owing to his breadth of intellect, indefatigable zeal and rare devotion to his projects." William Johnson died on October 11, 1875. At his death the Seneca Falls Savings Bank, (Continued)

During his ownership, the chapel became a public hall which, apparently, possessed the capability to host dramatic productions. One of the first events to take place was a political rally, with the Honorable William Dorsheimer of Buffalo, "an eloquent champion of the liberal cause," who spoke on the day's political issues on October 11, 1872. He was followed by General John C. Caldwell of Maine who made a "ranting Radical speech" on October 14. The Catholic Society fair soon followed on October 22, 1872.⁶ Many types of activities, social, political and religious, occurred at the hall in subsequent years. (See Appendix E for a listing of Johnson Hall activities. See illustrations 19 to 22 for handbills of Johnson Hall events.)

Johnson Hall Appearance and Repairs

Soon after Johnson Hall opened for business a new drop curtain was put in place. Additionally, a banner was hung on the building's outer

5. (Cont.) of which he was president, was draped in mourning and the Island Works business was suspended. An obituary called him "the acknowledged wit of the Senate." Welch, "Grip's" Historical Souvenir, pp. 134-135; Untitled newspaper clipping, pencil notation "Jour 10-11-75," Personal Papers, Johnson, Archives Collection 37, Box 10, Folder 14, SFHS History of Seneca Co., plate XLIV. Colonel William Johnson's military and political career can be followed with some regularity in the local newspapers during the 1860s to mid-1870s. See: Ovid Bee, November 11, 1863; Seneca County Courier, April 18, 1861; Ibid., April 25, 1861; Ibid., August 21, 1862; Ibid., September 4, 1862; Ibid., September 18, 1862; Ibid., January 9, 1873; Ibid., August 14, 1873 for data on William Johnson's contribution to Seneca County's military, political, and economic history. One of his election notices in the Reveille read: "Vote for Col. William Johnson for State Senator. Let that gallant soldier and true Democrat have every vote. He never falters in his Democracy. He never tries to sell the soldiers out to the advocates of negro suffrage. He never talks one way and votes another. You know where to find him every time. Remember him at the ballot box; and let him go out of his county with a rousing majority that shall show the people of the district how he is regarded at home!" Reveille, November 4, 1865. It is one of those interesting twists of history that Johnson's wife, Angeline, was the daughter of one of the attendees at the 1848 Women's Rights Convention, where, of course, women's suffrage was advocated.

6. Reveille, September 27, 1872; Ibid., October 4, 1872; Ibid., October 18, 1872.

wall. The work was done by Curtis, Shandley & Co. These painters were also hired by William Johnson and Albert Jewett to paint and fresco the hall's interior. George E. Stevens, who managed the hall, supervised the work in November 1872. According to the Reveille: "The auditorium is to be finished in calcium colors, and the stage and scenery in oil colors. The scenery, when completed will be of handsome and unique designs and fully equal to that of the best opera houses. Instead of the old fashion slide scenery, there will be scenes with fly-wings, arranged in such a manner that each scene will be separate and distinct from each other."⁷

By April 1873 the Reveille reported that scenery for Johnson Hall had been completed and was being installed in the building by Leon Lempert, scenic artist of the Rochester Opera House. Thus, Curtis, Shandley & Co., may not have completed the work, as previously announced. Additionally, "The stage is being enlarged, and otherwise improved for dramatic exhibitions." The work was finished by April 18, 1873, and was pronounced, "very fine, indeed."⁸

An 1881 Sanborn map provided details of the Johnson Hall's construction, and how the building was changed from a chapel into a public hall. It was a two-story brick building with a shingle roof; the east and west walls had five windows each. Two stores, vacant in 1881, were on the first floor level, while the hall was on the second floor. A brick wall on the first floor created a separate room on the north end of

7. Reveille, November 29, 1872. Curtis, Shandley & Co., had its office in Jewett's Block at 85 Fall Street. John A. Curtis, who lived at 11 Mynderse Street, and George Shandley, of 16 Walnut Street, specialized in paints, oils, varnishes, window and picture glass, wall paper, window shades and fixtures. Their newspaper advertisement also mentioned the firm carried "CHROMOS, LITHOGRAPHS, PHOTOGRAPHS, LOOKING GLASSES, FRAMES, SQUARE, OVAL, MOULDINGS, &c., &c., &c. And all Goods connected with their trade." Reveille, December 6, 1872; 1874 Seneca Falls Directory, pp. 43, 94.

8. Reveille, April 11, 1873; *Ibid.*, April 18, 1873.

the building. Speculation has been made that the chapel may have been enlarged in 1857. Church records, however, do not mention the chapel being enlarged, but the "extensive repairs" could have included enlarging the chapel. Additionally, two rooms, the "conference room" and the "prayer room" are both mentioned for the first time in 1858. The 1872 Reveille article on the remodeling does not mention an enlargement. A 1917 newspaper clipping describing renovations in that year mentioned the additions to the front and back of the building when it was converted from a chapel into a public hall, but this may have been a reference to a 1890 addition, and not the earlier one, carried out either in 1857 or 1872. An 1886 Sanborn map detail revealed no changes from the 1881 Sanborn map, with the exception of the addition of what appears to be an outhouse. (See 1881 Sanborn map detail, illustration 23, and 1886 Sanborn map detail illustration 24.) Thus the documentation is unclear as to exactly when the first north addition was made--1857 or 1872.

Johnson Hall Tenants

When the Wesleyan Chapel was remodeled, space for two stores was created in Johnson Hall.⁹ A co-operative grocery might have been a

9. The 1862 Seneca Falls Directory gave the Wesleyan Chapel's address as 142-144 Fall Street. The city directories for 1867, 1874, 1881, 1888 and 1890 give no listing or address for the chapel or Johnson Hall. The street numbers changed at some time between 1881 and 1888, however, for the Johnson home address on Cayuga changed from 37 to 53. Village tax records for 1884-1887 refer only to lot number and Fall Street for the Johnson Hall, no numerical address is provided. County tax records, which might have provided a numerical address, were not available for this time period. Using the 1894 directory address of 67 Fall Street in the search for Johnson Hall tenants in the 1870-1890s proved invalid; newspaper ads for these possible tenants placed them elsewhere on Fall Street. These businesses included S.L. Jacoby insurance, lawyer Charles A. Hawley, and C.C. Penoyer meat market, but in the mid-1880s, the Mundy Building was at 67 Fall Street. Additionally, the 1881 Sanborn map gives the Johnson Hall address as 827-828 Fall Street, but Seneca Falls directory street address numbers are not this high. The 1886 Sanborn map detail gave the address as 1620-1621 Fall Street. Thus, Johnson Hall tenants are documented only from newspaper articles, or advertisements.

tenant when Johnson Hall first opened.¹⁰ In May 1875 E.T. Boyd advertised in the local newspapers that he had purchased the Seneca Falls furniture warerooms, located in Johnson Hall Block, where he would continue the business.¹¹ A Reveille advertisement read:

The furniture warerooms of Mr. E.T. Boyd, in Johnson Hall building, offer advantages to purchasers fully equal, if not superior to any other house in this vicinity. His stock is replete with every description of parlor, dining-room and chamber sets, marble-top and plain tables and stands, sofas, lounges, chairs of every kind, bureaus, beds and bedsteads, and every other article that is usually found in a first-class furniture store--all offered at prices lower than ever before.¹²

The furniture store did not remain in Johnson Hall for very long, however, for E.T. Boyd moved the business into Zalinski's Block, where he would have more room, in November 1875.¹³

10. Reveille, September 30, 1872. The 1874 Seneca Falls directory does not identify a co-operative grocery at the address of 144 Fall. The only business listed at that address was that of W.J. Allen & Co., carriage and wagon maker, with P. Feeck, agent. However, photographs of Johnson Hall in the 1870s reveal a carriage maker on the corner of Mynderse and Fall streets opposite the hall. 1862 Seneca Falls Directory, p. 71; 1874 Seneca Falls Directory, pp. 26, 113.

11. Reveille, May 7, 1875; Seneca County Courier, May 13, 1875. The 1874 Seneca Falls directory did not contain a listing for E.T. Boyd.

12. Reveille, May 7, 1875.

13. Seneca County Courier, November 18, 1875; Reveille, December 24, 1875. Adding to the problems with identifying tenants in Johnson Hall, Angeline Johnson owned the Johnson Block, located on the south side of Fall Street opposite the post office in the Partridge Block. A blacksmith and wagon maker named George Yetter announced in February 1877 that he had purchased the "well known stand on the CORNER OF FALL AND MYNDERSE STREET," and that he had opened two stores in the Johnson Block, to be filled the harnesses, blankets and robes. The Yetter business was probably located on the northeast corner of Fall and Mynderse streets where the Feeck and Allen businesses had stood, thereby accounting for the "well known stand." Seneca County Courier, February 22, 1877; *Ibid.*, March 5, 1891.

The 1881 Sanborn map detail of Johnson Hall reveals both stores in the building to be vacant, while the 1886 Sanborn map detail shows the two store areas occupied by "H & L Ho." and "Hose Ho," with a plumber located in the north end of the building. Further information on these businesses was not found. The initials may refer to "hook" and "ladder." (See illustration 23 for 1881 Sanborn map detail and illustration 24 for 1886 Sanborn map detail.)

Johnson Opera House

Both community events and stage performances were held in Johnson Hall until 1890, when the building's name was changed to Johnson Opera House. After William Johnson's death intestate, his wife Angeline and sole remaining son Charles inherited his property.¹⁴ (See illustration 25 of Charles Chamberlain Johnson.)

14. Angeline Chamberlain Johnson and her son Charles Chamberlain Johnson were prominent citizens of Seneca Falls. Angeline Johnson owned property, some pieces individually and others partially with her son, including, at various dates in the 1880-1890s, the house and barns on Cayuga Street, other houses in the village, two farms, the Johnson Hall, the Phoenix Mills on Canal Street, the Halsup House on State Street and the four-store complex known as Johnson Block. One of the farms she owned was the Kingdom Farm (100 acres) which she inherited from her father, Jacob P. Chamberlain's, estate in 1879. She owned this farm until her death and left it to her son Charles. Angeline Johnson also owned property in Tarrytown, New York, and other property "in the South." Village of Seneca Falls Tax Assessment, 1884, p. 27. These village tax books were located in autumn 1985 in a vault in the former village offices on Fall Street. (Hereafter cited as "Village tax"); Seneca County Tax, 1900, p. 35; These tax books were located in autumn 1985 in the Seneca County historian's office, in the Health Building in Waterloo. (Hereafter cited as "County tax"); 1984 Seneca Falls Directory, p. 311; Deed Book 122, March 10, 1904, p. 163, SCCW. As a prominent member of Seneca Falls society, her name often appeared in the local newspaper society columns. See sample items in Seneca County Courier, July 10, 1890; *Ibid.*, July 17, 1890; and in Seneca County Journal, May 11, 1892. By the early 1890s Angeline Johnson was living at 92 West 89th Street in New York City, where her son was in law school. After the Seneca Falls fire in 1890 she sold the lot where the Johnson Block had stood, in (Continued)

It is not known how the hall was managed or who managed it after William Johnson's death, but by 1891 when Charles C. Johnson reached adulthood, he had become the Johnson Opera House's manager.¹⁵

The change from hall to opera house occurred after the July 30, 1890, fire in downtown Seneca Falls which destroyed three full acres in the heart of the business district. The fire damage missed Johnson Hall only by half a block, as it destroyed the Hoag Hotel on the corner of State and Fall streets. (See illustrations 26 and 27 of the 1890 Seneca Falls fire.) More importantly, Daniels Opera House on the corner of Fall and State streets was burned. The Reveille rhetorically asked, "What are

14. (Cont.) addition to a lot on the corner of Fall and State streets, opposite the Hoag Hotel, where the Miller Block was soon erected. Seneca County Courier, March 5, 1891; *Ibid.*, September 10, 1891. Angeline Johnson evidently managed her business affairs cojointly with her son; they held several mortgages together in the 1890s. After her death on November 14, 1901, Charles Johnson had to establish he was the sole surviving Johnson heir for business purposes. In May 1908 the Johnson homestead on Cayuga Street was sold at foreclosure. Deed Book 122, March 10, 1904, p. 163, SCCW; Mortgages Book 76, July 11, 1892, p. 517, SCCW; Discharges of Mortgages, Book 10, July 14, 1897, p. 108; Mortgages Book 77, August 3, 1892, SCCW; Discharges of Mortgages, Book 10, July 3, 1897, p. 105, SCCW; Mortgages Book 84, July 2, 1897, p. 44, SCCW; Discharges of Mortgages, Book 16, May 9, 1918, p. 374, SCCW; Reveille, May 1, 1908. Charles Chamberlain Johnson was born in 1869 in New York City, moved to Seneca Falls in the early 1870s, and lived in the Johnson home on Cayuga Street. He graduated from Mynderse Academy in Seneca Falls, Cornell University in Ithaca, and attended Columbia College Law School in New York City. He was admitted to the bar in 1892, and served as district attorney of Seneca County from 1896-1899. His law office was in the Daniels Block on Fall Street. After the death of his mother, Charles Johnson moved permanently to New York City, where he practiced with the firm of S.F. and D.E. Meeker. In 1912 he was living at 217 Havemeyer Street in Brooklyn. He died in 1946. Welch, "Grip's" Historical Souvenir, p. 135; John S. Gay, "Lawyers of Seneca Falls, New York," Paper delivered before the Seneca Falls Historical Society May 12th, 1949, Seneca Falls History Collection (General), Archives Collection 28, Box 2, Folder 5, SFHS; Seneca County Courier, October 9, 1890; Masonic Daily News, January 27, 1902; Village tax, 1912, p. 41.

15. Seneca County Courier, October 1, 1891; 1894 Seneca Falls Directory, p. 593.

we to do without an opera house?" The Daniels Opera House owner, Milton Hoag, was in no position to rebuild, so the newspaper offered a challenge: "Some other and younger person should exhibit their enterprise by giving us a fine opera house."¹⁶

Angeline Johnson's response was to convert Johnson Hall into an opera house. By September 1890 she had updated the building's accommodations. The Seneca County Courier offered a general description: "The refitted and enlarged Johnson hall will be a very commodious and elegant opera house. Its seating capacity will be nearly 700, and its arrangements for lighting, warmth and ventilation are such as to render it both comfortable and healthful."¹⁷ The new opera house's comfort was publicly praised; the Seneca County Courier urged its readers to go see for themselves: "It will be a treat to see the elegant appointments of the house, to say nothing of the entertainment."¹⁸

The opening production on November 1, 1890, was the Rochester Mandolin orchestra company, with Jessie Bonstelle, elocutionist. Both the performance and the opera house received praise in the Seneca County Courier: "The new opera house is a gem of beauty and convenience, containing everything that modern improvement could suggest."¹⁹ (See illustrations 28, 29, and 30 for the Johnson Opera House.

Charles Chamberlain Johnson managed the theatre for many years in addition to practicing law, and was praised for the quality entertainment he brought to Seneca Falls. When the "celebrated Sam Small" provided

16. Seneca County Courier, July 31, 1890; Reveille, August 15, 1890.

17. Seneca County Courier, September 25, 1890. The paper also remarked: "Mrs. Johnson is also building upon her vacant lots on State street, where she proposes to erect a block of stores. Her public spirit is very advantageous to the town in this time of its desolation." This is interpreted to mean that Angeline Johnson was the moving spirit behind the Johnson Hall enlargement, rather than her son Charles.

18. Seneca County Courier, October 30, 1890.

19. *Ibid.*, November 6, 1890.

entertainment in July 1891, the Seneca County Courier remarked: "Mr. Johnson is untiring in his effort to procure the best talent for the entertainment of the public and it is hoped that a just appreciation of his effort may be shown by greeting Mr. Small with a crowded house. . . ." ²⁰ When Charles Chamberlain Johnson was out of town and after he moved to New York, others were hired to manage the opera house. ²¹

Theatre seasons usually ran from September until June. Musicians were employed to provide live music for the productions. In September 1891 the Seneca County Courier remarked: "Good music will be a special feature at Johnson Opera House during the season about to open. A fine new piano has been secured and a first-class orchestra of six pieces engaged. Everybody will enjoy the music, and, with the high ranking entertainments already booked, an enjoyable season is promised to the play-going public." ²²

Productions occurring in the opera house ranged over a wide field of entertainment, from burlesque to tragedy to minstrel. From 1890 to 1915 the chapel turned opera house hosted both local productions with Seneca

20. Ibid., June 25, 1891.

21. During an absence of Johnson in October 1891, those desiring to engage the opera house for "entertainments, balls etc." were to contact George W. Shewman to arrange "satisfactory terms." Seneca County Courier, October 1, 1891. In 1902 W.P. McCaul managed the opera house. 1902 Seneca Falls Directory, p. 89. By 1907 one "Doyle" leased the business from Charles Johnson and brought in plays and other events. He was praised by the Reveille for his efforts: "Neil Doyle is trying to make everybody happy these dreary days by the production of amusing plays at the Opera house. He may not be as fully rewarded as he should be, but, then, he is an optimist, and believes in things, all the same. His just reward is only a question of time." Reveille, March 22, 1907; Ibid., January 17, 1908. Doyle's name appeared in various newspaper articles as Neil Doyle and as James C. Doyle. Most of the articles referred to him only by his last name.

22. Seneca County Courier, September 3, 1891; Seneca County Journal, June 1, 1892.

Falls citizens taking leading roles, and national touring theatre companies. Political meetings continued to be held, as were church benefits and gatherings in the interest of changing society, such as prohibition. Near the end of the opera house's life, the revolution in entertainment can be observed, with the demise of burlesque and other forms of live theatre, and the introduction of the showing of moving pictures. A significant anniversary of the 1848 Women's Rights Convention was also observed in the opera house, along with the 100th anniversary of Elizabeth Cady Stanton's birth.²³ (See Appendix E for a partial listing of Johnson Opera House events. See illustrations 31 to 37 for Johnson Opera House handbills.)

1908 Observance of 1848 Women's Rights Convention

Harriot Stanton Blatch, daughter of Elizabeth Cady Stanton, came to Seneca Falls in March 1908 to plan the 60th anniversary observance of the 1848 Women's Rights Convention. The Seneca Falls Historical Society cooperated with the Equality League of Self-Supporting Women in arranging the ceremonies, which included placing a commemorative tablet on the east outside wall of Johnson Opera House. The celebration was held on Wednesday May 27, 1908, with the unveiling at 11:30 A.M. The Reverend Annis Ford Eastman of Elmira, New York, and Mary Church Terrell of Washington, D.C., made speeches. Subsequent proceedings included exercises at Mynderse Academy for students and late afternoon speeches in the opera house by local citizens and nationally known women's rights advocates honoring women's rights pioneers. An evening meeting was held at the Presbyterian church.

23. For more information on amusement halls and opera houses in Seneca Falls see Fred Teller, "Union Hall, Daniels Hall, Daniels Opera House and Other Amusement Halls of Seneca Falls," in Papers read before the Seneca Falls Historical Society for the year 1905. This article may be found in Seneca Falls Historical Society Papers 1904-1911/12. This article only mentions Johnson Hall in passing, that the opera "Pepita, the Gipsy Girl of Andalusia" was performed there. The opera, produced with local talent, was so successful that it was repeated again at Daniels Hall on January 16, 1877.

In addition to Blatch and Terrell, speakers and attendees included Margaret Stanton Lawrence; Lillie Devereaux Blake; Reverend Antoinette Brown Blackwell; William Lloyd Garrison's daughter, Fannie Garrison Villard; Elizabeth Smith Miller; Martha Wright's daughter, Eliza Wright Osborne; Maud Nathan of the New York Consumers League and others. Seneca Falls resident Mary Conklin Hubbard, one of the original signers of the 1848 Declaration of Sentiments, attended the ceremonies.²⁴ (See illustration 38 of the anniversary observation.)

1915 Observance of Elizabeth Cady Stanton Birthday

Elizabeth Cady Stanton's 100th birthday was celebrated in November 1915 at the Johnson Opera House. Local residents who remembered Stanton from her years in Seneca Falls offered their remembrances, while much of the rhetoric focused on the topic of women's suffrage. Harriet Stanton Blatch was unable to attend; her sister Margaret Stanton

24. "Anniversary Celebration of the 1848 Woman's Rights Convention, Seneca Falls, Wednesday, May 27th, 1908" program leaflet, Women's Rights National Historical Park files (Hereafter cited as WOR1); "Place Tablet in Opera House," undated newspaper clipping (with notation 1908), WOR1 files; Reveille, March 20, 1908; Ibid., May 1, 1908; Ibid., May 22, 1908; May 29, 1908. All of the proceedings were published by the Seneca Falls Historical Society. See: "Proceedings of the Sixtieth Anniversary of the Woman's Rights Convention Held in Seneca Falls in July, 1848," in Papers read before the Seneca Falls Historical Society For The Year 1908, pp. 26-73. This article may be found in Seneca Falls Historical Society Papers 1904-1911/12. The tablet reads:

On this spot stood the Wesleyan Chapel where the first Woman's Rights Convention in the world's history was held July 19 and 20, 1848. Elizabeth Cady Stanton moved this resolution, which was seconded by Frederick Douglass: "That it is the duty of the women of this country to secure themselves their sacred right to the elective franchise." Some of the signers of the Declaration of Rights: Lucretia Mott, Jacob P. Chamberlain, Martha Ca. Wright, Elisha Foote, Amy Post, Charles L. Hoskins, Mary Ann McClintock, Richard P. Hunt, Lavina Latham, Jonathan Metcalf, Mary H. Hallowell, Henry W. Seymour

Lawrence offered a speech which was "directly against the attitude of the local organization, and was deeply resented by the audience," which was largely female. One of the few remaining attendees of the 1848 Women's Rights Convention was present, Rhoda Palmer of Ontario County.²⁵

The Johnson Opera House was decorated for the occasion. According to a local newspaper:

The interior of the old opera house never presented a more attractive or brilliant scene [sic] with the colors of the Suffrage organization neatly arranged upon the wall, while many American flags at different places and one especially large one draped across the stage, added to the attractiveness and patriotism of the occasion. Hung on the walls were large pictures of Elizabeth Cady Stanton,²⁶ Judge Daniel Cady, her father, President Wilson and others.

Johnson Opera House Appearance and Repairs

Contemporary newspaper accounts of the Johnson Hall conversion into an opera house provided only general data on the work. An 1897 Sanborn map provided details which match the information given in the newspapers. The hall was enlarged again in 1890 through an two-story addition on the north end of the building. A wooden staircase stood on the exterior of the building's north and exterior. The opera house was located on the second floor, with the stage and scenery at the north end,

25. "Stanton Centennial Celebration," undated newspaper clipping, Archives Collection 37, Local Historical Personalities E.C. Stanton, Box 40, Folder 5, SFHS; "Stanton Centennial A Successful Affair" newspaper clipping with penciled notation "Oct. 15, 1915," in Scrapbook #3, p. 71, SFHS. Margaret Stanton Lawrence later apologized for her offensive remarks, which were apparently directed towards her mother's former neighbors in Seneca Falls. "I deeply regret that the story I told Friday evening of Mrs. Stanton's neighbors should have caused any personal feeling. I referred to a few isolated cases back in 1848. I am particularly sorry because my mother always had the warmest regard for her early friends and neighbors of all nationality in Seneca Falls."

26. "Stanton Centennial"

and a plumber, probably a tenant, located on the first floor. An additional brick wall on the first floor created another room; and the heater was located on the first floor. Tenants in 1897 appear to be "bowling" and a "repair shop" along with the plumber; very little further information concerning these businesses was found. A Johnson Opera House handbill referred to "Preston's Bowling Alley and Billiard Parlor," located in the "Johnson Opera house Block" in 1898. (See illustrations 40 and 41 for 1896 Seneca Falls map detail and 1897 Sanborn map detail. See advertisement on handbill, illustration 32.)

An 1911 Sanborn map revealed tenant space on the first floor, with the opera house still situated on the second floor. The two-story addition on the building's north end in 1897 was now three stories, with a three-story frame staircase attached on the exterior. The building's roof was now either tin or slate, with a composition roof over the staircase. Steam heat and electric lights had been installed by this time. At the north end of the building general repairing work was carried on in the northernmost room on the first floor, while dressing rooms were located on the second and third floors at the northernmost end of the building. The stage and scenery remained on the second floor, but had moved 20 feet southward to make room for the dressing rooms. The initials "UB" appeared; this may refer to a possible upper balcony placed around the back stage area for the stage crew. (See illustration 42 for 1911 Sanborn map detail.)

Only two interior photographs of the opera house have been found, and the authenticity of both are open to scrutiny. A photograph of a theatre interior is thought to be Johnson Opera House. Only two people in the photograph have been identified by Seneca Falls Historical Society staff. The name of the production is not known, and it is only a guess that the scene was indeed in the Johnson Opera House. (See illustration 43.) A second interior photograph is of the stage and hall, with chairs. The accompanying caption cited a roller skating rink being located inside the opera house, and this description is supported by newspaper advertisements in 1906-1908 for roller skating in the opera house. (See illustration 44.)

Data on repairs from 1890-1915 is scarce. A new roof was put on the Johnson Opera House in July 1892. The Seneca County Roofing Company did the work, and a local newspaper remarked: "The Johnson Opera House roof looks as slick and smooth as a toboggan slide, . . ."27 In August 1893 "Artist Smith" had nearly finished work on the opera house's drop curtain and scenes.²⁸

In January 1901 a fire occurred inside the opera house. E.S. Nowotmy was presenting "wargraph entertainment" when his machine caught fire.

The programme was about half over and a fire scene had just been announced when there was a cry of fire from the gallery followed by a loud crash of breaking glass. All heads were turned in the direction of the gallery and the sight that met their eyes struck terror to their hearts. A sheet of flame and black smoke was going up from the machine to the ceiling, and rapidly spread through the room. Everyone was seized with a wild desire to get out, believing that the whole place was on fire. What no doubt added greatly to the general panic was the fact that the seats were not fastened to the floor, being so arranged that they can be removed for dances and as the people rose to their feet these moved. . . . The cause of the accident was a film that slipped down on the rheostadt, and, being composed of celluloid, instantly ignited. Mr. Nowotmy endeavored to put it out with his hand but the flame caught among a number of loose films that had been laid aside after being used and thence to the curtains surrounding the machine.²⁹

By 1906 the years and continuous use must have taken their toll on the building. The Reveille reported in September that the opera house was being much improved and made more comfortable and convenient.

27. Seneca County Courier, July 14, 1892; Seneca County Journal, July 20, 1892. No listing for Seneca County Roofing Company was found in the 1894 Seneca Falls directory.

28. Seneca County Journal, August 30, 1893.

29. "A Panic at Seneca Falls" newspaper clipping with pencilled notation "1901," Scrapbook #21, p. 31, SFHS. Fortunately, there were no fatalities among the 500 people who ran, panic-stricken.

"There was great need of it." These repairs were probably not adequate because in October the newspaper called for a new opera house to be built, or for a unique offer to be accepted:

A reputable citizen of the place says if the village or the people of the village will purchase Johnson Opera house property and present to him a deed thereof, he will expend a sum equal to the purchase money in enlarging and fitting the building for a suitable Opera house. This is a proposition worthy of consideration. The pressing demand³⁰ for a modern Opera house should prompt an effort of this kind.

The newspaper optimistically predicted in November that "The opera house here will be put in good condition for good entertainments."³¹ Evidently nothing was done as editorial remarks were again printed in the paper in the spring of 1907. Once again, changes were being proposed:

It has been decided to materially enlarge, improve and beautify Johnson Opera house, and the work will begin as soon as the show season is over. The stage part of the house will be heightened, the front changed, a new entrance made, and the whole place made convenient and attractive. No expense or effort will be spared to render it a desirable and delightful play house.³²

Surely the opening of the 1908 season would find the "Opera house greatly improved and beautified, and in much better condition for first-class shows."³³

The sale of the building did not occur and James C. Doyle, the building's lessor, managed the opera house events for the 1907-1908 season. Again, in April 1907, the newspaper reported planned changes:

30. Reveille, September 14, 1906; *Ibid.*, October 12, 1906; *Ibid.*, October 26, 1906.

31. *Ibid.*, November 2, 1906.

32. *Ibid.*, March 8, 1907.

33. *Ibid.*, March 22, 1907.

The building will be very much improved when the present season is at an end. The stage will be enlarged and made more convenient, and furnished with better and more attractive scenery. The interior of the building will be handsomely decorated and its seating accommodations rendered more comfortable. The front will be remodeled and a safer and better entrance perfected. People who have looked anxiously forward for a more desirable opera house, one in keeping with public requirements and in all respects a credit to the village, will have to wait for a more auspicious condition of things. In the meantime, the present structure will be materially improved and made as convenient as is possible.³⁴

By mid-summer, however, no action had been taken, even though another building tenant, Charles H. Powers, ran advertisements for a "Re-Construction Sale." (See illustrations 45 and 46 for Powers' advertisements.) The Reveille editorially remarked that if a safe and comfortable play house was going to be used in the coming winter, alterations should have been started. Only in August was a contract let. The opera house was to be ready for use by September.³⁵ Apparently the expected changes were not made. In September the Reveille still discussed the needed work: "Some changes and improvements will be made to the house and a better and safer entrance provided. There is great need of it. Inasmuch as it is the only playhouse in town, it ought to be put in a safe and proper condition."³⁶

No other mention of repairs during this period was found, and the existing record in the Reveille is confusing and incomplete. The 1911 Sanborn map does show, however, that at least the stage had been enlarged with the addition of a third story at the northernmost end of the building. It was during this period that substantial physical changes were occurring in the building's neighboring environs. In January 1906 "Manager" Doyle installed a "magnificent electric light of a latter day

34. Ibid., April 19, 1907.

35. Ibid., July 26, 1907; Ibid., August 9, 1907.

36. Ibid., September 4, 1907.

pattern," in front of the opera house. It illuminated the street and was "extremely brilliant and attractive." In 1907 and 1908 the village of Seneca Falls suffered through the installation of village sewers, municipal water and street paving. Fall Street was paved by December 1911 and Mynderse Street by August 1920.³⁷

Other repairs to the building occurred in 1912. Charles H. Powers, the tenant with a furniture business located on the opera house's first floor, advertised that he was temporarily going out of business "on account of extensive repairs to be made during the present year on the building which I now occupy, I am obliged to vacate for a time."³⁸ The nature of these repairs is not known.

Tax records do not pinpoint when changes occurred or when repairs were made. The village tax records show the Johnson Hall's value in 1884 to be \$5,000; in 1886 the value rose to \$6,000, where it stayed until 1890. By 1894 the value was \$6,500 and by the time Charles Johnson sold the opera house in 1915 the property was valued at \$7,500.³⁹ Seneca County taxes were based on the same valuation of the opera house; in 1902 the property was worth \$6,500, rising in 1912 to \$7,000, which was its value at the time Johnson sold it in 1915.⁴⁰

Selling Portion of Opera House Lot

Angeline and Charles Johnson sold a portion of the opera house lot to Emmett J. Ryan Sr. on September 19, 1891. The property consisted of 25 feet off the north end of the land sold to William Johnson by the

37. Ibid., January 25, 1906; Ibid., May 10, 1907; Ibid., October 2, 1908; Ibid., December 15, 1911; Ibid., August 27, 1920.

38. Seneca County Courier-Journal, June 13, 1912.

39. Village tax 1884, p. 27; Ibid., 1886, p. 28; Ibid., 1887, p. 28; Ibid., 1890, p. 31; Ibid., 1894, p. 30; Ibid., 1915, p. 53.

40. County tax, 1901, p. 35; Ibid., 1912, p. 47; Ibid., 1915, p. 65.

Corwins.⁴¹ An 1896 Seneca Falls map confirms that Ryan built a structure behind the opera house. An 1897 Sanborn map indentifies the structure as an undertaking establishment. The 1902 Seneca Falls directory listed Ryan's undertaking business at 26 State Street, but the 1910 directory listed "Ryan's Morgue" at 7 Mynderse Street.⁴² (See 1896 Seneca Falls map detail and 1897 Sanborn map detail, illustrations 40 and 41.) The sale of this strip of land from the original Wesleyan Methodist property is the only such transaction documented in the Seneca County deeds.

Powers' Furniture Store and Doyle's Picture House

By the mid-1910s the character of the Johnson Opera House's entertainment had changed. The phenomenon of moving picture shows was introduced at least by 1906 by the opera house's lessor proprietor, James C. Doyle, and in 1914 his widow Nellie Doyle was continuing the business. Doyle's Picture House operated in the opera house at 124-126 Fall Street.⁴³ In November 1915 Nellie Doyle sold her moving picture show equipment to Milton Carr, who then conducted the business and charged \$.05 for each evening's show in the opera house.⁴⁴

41. Deed Book 109, September 19, 1891, p. 339, SCCW. Emmett J. Ryan Sr. was a prominent furniture dealer and undertaker in Seneca Falls. Seneca County Courier-Journal, June 18, 1931.

42. 1902 Seneca Falls Directory, p. 126; 1910 Seneca Falls Directory, p. 0.

43. 1910 Seneca Falls Directory, p. 56; 1914 Seneca Falls Directory, pp. 60, 1. James C. Doyle operated the Doyle saloon and restaurant in the Sharp building at 2 Ovid Street for eight or nine years before selling it in 1907. The Reveille remarked: "Mr. Doyle, having engaged more or less in the show business, will now have ample time to devote himself to this line of recreation for which he seems so well adapted. Reveille, January 11, 1907; 1906 Seneca Falls Directory, p. 40. Nellie Doyle owned a house at 5 Beryl Street in 1914, and was the proprietor of Doyle's Store at 121 Fall Street.

44. Reveille, November 5, 1915.

Another business located in the opera house was Charles H. Powers' furniture store. Powers was conducting this business in the building as early as 1902, and the 1911 Sanborn map showed a furniture store occupying the opera house's first floor. (See illustration 42.) On December 27, 1915, Charles Chamberlain Johnson and his wife Frances M., living in Brooklyn, sold the opera house to Charles Powers.⁴⁵ The Reveille commented on the sale:

The sale of Johnson Opera House property to Charles H. Powers was perfected last week and the property is now in new hands. . . . Mr. Powers has occupied the front of the building with his furniture business for a good many years, and it is his purpose to improve it and make it more available for general use. He will remain where he is, and the upper part will be continued as a public hall. The entire structure will be remodeled and made more attractive. The main part of the building was the Wesleyan Methodist church and was erected early in the '40s, but disposed of when the society built its new church on the corner of Fall and Clinton streets. It then became a public hall with the lower story fitted for stores. It is good property, conveniently located, and Mr. Powers will see that it is greatly improved for present and future use. He should immediately change the name of the property.⁴⁶

45. Deed Book 136, December 27, 1915, p. 591, SCCW; Reveille, April 12, 1907. Charles Powers was born in Norfolk, St. Lawrence County, in 1859. In 1894 he was an upholsterer and dealer in fine parlor furniture, with his business located in the Union Hall Block on Ovid Street. He boarded at the Franklin House. In 1900 his furniture business was at 119 Fall Street, and by 1902 the business was listed in the "Opera House Block." In 1906 the business was listed at 144-146 Fall Street; by 1910 the address of the opera house with the furniture business had changed to 154-156 Fall Street. In 1917 Powers advertised that he had, by that time, been in business for 23 years. He lived with his wife Nellie L. in a house at 97 Mynderse by 1906. Powers died in Seneca Falls in December 1932 at the age of 74. According to his obituary, "He conducted a furniture store here, and was well and favorably known. Quiet and unassuming in manner, and honest and upright in his dealings, he will be greatly missed." Seneca County Courier-Journal, December 8, 1932; 1894 Seneca Falls Directory, p. 345; 1900 Seneca Falls Directory, p. 64; 1902 Seneca Falls Directory, p. 119; 1906 Seneca Falls Directory, p. 62; 1910 Seneca Falls Directory, p. J; 1914 Seneca Falls Directory, p. 105; Reveille, June 15, 1917.

46. Reveille, January 7, 1916.

Charles Powers apparently made changes in the building beginning in February 1916. He advertised a "Special Reconstruction Sale" wherein he offered sale prices on his line of furniture. His newspaper advertisement read: "You will not recognize the old place after improvements are made, as he intends to have the largest and most attractive store in Seneca County."⁴⁷ It is not known what kind of improvements were made. (See illustrations 46-49 for Powers' furniture and advertisement.)

The moving picture business apparently continued in the second floor of the building. During the week of March 24, 1916, the proceeds from two evenings of the moving picture show were contributed toward financing a firemen's convention. At the end of March 1916, the Reveille announced that the "Johnson Opera house" would reopen "under new management" with a series of moving pictures. The new management was to present "splendid picture shows at popular prices."⁴⁸

Regent Theatre

It is not known if this "new management" was connected to building's sale on September 20, 1917. Charles and Minnie Powers sold the building to Asa B. Hilkert of Geneva, New York, who represented the management of play houses in Geneva and Ithaca, New York.⁴⁹ A local newspaper reported major renovations were to take place, thus raising doubts that the renovations advertised by Powers in the year previous actually occurred:

The building is to be thoroughly improved and made into a handsome picture and playhouse, the new owners expecting to

47. Reveille, February 4, 1916.

48. Reveille, March 24, 1916; *Ibid.*, March 24, 1916.

49. Deed Book 140, September 20, 1917, p. 587, SCCW; Reveille, August 24, 1917. The newspaper reported the sale as occurring on August 20, 1917, with possession taking place on September 1. These dates precede the date of sale given in the county deed book.

spend about \$17,000 in changes and alterations. The first floor will be utilized for shows. The change of ownership will result in greatly improved surroundings, and add very materially to the appearance of Mynderse and Fall streets. The work of alteration will begin at once, under the direction⁵⁰ of Mr. Hilkert, who is an experienced contractor and builder.

Asa Hilkert transformed the old opera house into a full scale moving picture theatre, the Regent Theatre. In October 1917 the contract for providing the seats was let to one Fred Teller. The number of seats ordered was 787, with November 10 the expected delivery date. At November's end the theatre was nearly completed. The Reveille reported that Hilkert had "converted it into a model structure of its kind by changes of the most elaborate character, very pleasing in appearance and most delightful in equipment."⁵¹

In December 1917 a local newspaper described the building's appearance as well as chronicled the local agitation for a new theatre, which resulted in the opening of both the Fisher Theatre and the Regent Theatre on Fall Street:

The new theater has been changed so much from the old structure, that its appearance, both the exterior and the interior, has but few indications of the old building.

The exterior of the building has been reconstructed and covered with white stucco. The entrance of the building has been changed from two side stairways to a wide entrance in the center of the building and a large portico built out over the walk in front of the entrance. Two stores occupy the street floor in front. The theater part of the old building was entirely on the second floor. Now the main part of the seating capacity of 700 is on the street level with only the balcony and boxes at the elevation of the Johnson Opera House auditorium. The interior is decorated in color scheme in which white and silver predominates.

The building entirely completed with two stores on the street floor and several suites of offices on the second floor, will cost the new owner about \$30,000. . . .

50. Reveille, August 24, 1917.

51. Ibid., October 5, 1917; Ibid., November 23, 1917; Ibid., November 30, 1917. In 1914 Fred Teller was a furniture dealer. 1914 Seneca Falls Directory, p. 121.

The Regent Theater building was originally a church. . . . Later the Wesleyans built the present church and additions were made to the front and rear of the building and it was used as the Johnson Opera House. After 1890 it was the only place where theatrical productions could be staged and for many years it was inadequate for that purpose so that agitation was started and very generally supported for the purchase of a site to be given to the person erecting a modern theater. The Fisher Theater was the result of that agitation. By the reconstruction of the Johnson Opera House building into the new theater, A.B. Hilbert, owner of the theater has improved the appearance of the business section and enhanced the value of all real estate in that part of Fall street. A.B. Hilbert had direct charge of the reconstruction of the building and drew the plans for the work.⁵²

Photographs of the Regent Theatre reveal that major alterations were made on the building. (See illustrations 50 and 51 of Regent Theatre.)

The opening date was set for December 7, 1917, when Asa Hilbert donated the use of the theatre for entertainment and a bazaar benefitting the Goulds Defense Guards. A 45-piece military band concert was featured, to "Help Bring Cheer to the Boys Who Will Fight Your Battle," during this year of world war.⁵³

The theatre's formal movie opening occurred on December 20, 1917. The first film featured was "Dormant Power" with Ethel Clayton starring.⁵⁴ The Reveille offered a description of the new theatre:

The formal opening of the new Regent Theatre was a feature of the local attractions last evening. The house was brilliantly illuminated and received unstinted praise for its fine appearance from a large and appreciative audience. The building has been finely refitted, refurnished and handsomely decorated and is in all ways a very creditable picture house, with every

52. "Regent Theater Opens Tomorrow" newspaper clipping with pencilled notation "1917," Becker Scrapbook 5, "Local and World Affairs 1917-1918," SFHS.

53. Reveille, November 30, 1917.

54. *Ibid.*, December 14, 1917.

convenience and comfort. It is the third place of amusement in the village and too much praise cannot be awarded to Mr. Hilkert, its owner, for his great outlay in⁵⁵ the production of a theatre house so complete in all its details.

In April 1918 the Regent Theatre, managed by L.E. Barger, was praised by the Reveille for showing "many fine pictures" and for "attracting large audiences."⁵⁶ It is an entertaining place to pass a pleasant hour in these strenuous times." (See illustrations 52-54 for Regent Theatre attractions.) Other events occurred in the theatre; a benefit performance was given for the Powhatan Lodge of Odd Fellows in March 1918, and Sergeant Douglas Aylen of Canada's fighting regiment "Princess Pat," lectured on the war and life in the trenches in May 1918. More significantly, the Baptist church in Seneca Falls began holding Sunday evening services in the Regent Theatre to save the expense of light and fuel in their church. The theatre was to be lit and heated for anyone who wanted to use the building during the extreme winter weather in January 1918.⁵⁷ Thus, 75 years after its construction, the converted Wesleyan Chapel continued to host religious meetings.

During this time period two tenants moved into the theatre. Optometrist and physician Dr. Albert J. Frantz opened his business in January 1918 on the second floor on the Fall Street side. Dr. Frantz occupied the premises at least until 1929, and perhaps until his death in 1932 at age 82.⁵⁸

55. Ibid., December 21, 1917.

56. L.E. Barger was a former resident of Geneva, New York, who came to Seneca Falls from Buffalo, where he managed a large picture theatre. "Regent Theater Opens Tomorrow".

57. Reveille, April 26, 1918; Ibid., February 22, 1918; Ibid., May 24, 1918; Ibid., January 11, 1918.

58. Ibid., January 11, 1918; Seneca County Courier-Journal, September 22, 1932. Dr. Frantz got married in his office at 124 Fall Street in March 1926. Reveille, March 12, 1926.

Another long-term tenant was the commercial office of New York Telephone Company, whose principal office was 15 Dey Street, Manhattan. Asa B. Hilbert leased space approximately 17 feet by 21 feet on the ground floor of the former opera house, now located at 124-126 Fall Street, for a term of three years, from January 1, 1918, until January 1, 1921. The yearly rent was \$420. New York Telephone Company had the right to make any interior changes, alterations, additions or other improvements to the building, including to the partitions and plumbing work inside, as the company needed. It also had the right to bring in, from underground or overhead, wires, pipes, or cables as necessary; to erect fixtures and appliances on the outside and in front of the building; to introduce from the street into the basement of the building, wires, pipes and cables, and to extend them to the building.⁵⁹

Hilbert provided running water; furnished a steam or hot water heating plant; and furnished and maintained one lavatory and water closet, connected to water and waste lines, in the basement of the building. He also was to keep the building in good condition, including the roofs, walls, hallways, stairs, approaches, entrances, exits, ceilings, windows and window lights.

At the end of two years, New York Telephone Company could renew the lease for another two years at the same conditions and rent.⁶⁰ This business office remained in the building until April 28, 1934, when it moved into the Hotel Gould at 114 Fall Street. The company's manager stated the new office provided more space and was more convenient for customers because it was located nearer Seneca Falls' business center.⁶¹

59. Deed Book 141, October 3, 1917, p. 315, SCCW.

60. Ibid., p. 316.

61. Seneca County Courier-Journal, May 10, 1934.

Seneca Falls Garage, Inc.

The Regent Theatre only survived two years.⁶² Asa B. Hilkert sold the building in October 1919 to Bertrand G. Mackey and Frank G. Knox. More physical changes were planned for the building. The Reveille detailed the new owners' intentions:

The structure will again be made into a two story building with a ball room on the upper floor and the street floor will be converted into a garage and automobile repair shop. The transaction involved substantially \$35,000. The theatre will be closed as a picture house on November first and possession will be given the purchasers about January first. In two months' interval Mr. Hilkert will execute a contract the purchasers have given him, for changing the building to suit its new uses.

The Fall street front of the building will not be changed materially, the G.L. Ayers store and the offices of the New York Telephone company, and the offices above, remaining as they now are.

The theatre entrance will be made into an entrance for the garage and about half the length of the building back on the Mynderse street side, another garage entrance will be made. The dance hall floor will be substantially on a line with the elevation of the present balcony and there will be two stairways leading into the hall from the Fall street side. The rear end of

62. Perhaps the Regent Theatre's short life was due to competition from other moving picture houses in the village. Three theatres operated in Seneca Falls at this time, offering both plays and moving pictures; the Regent Theatre, the Fisher Theatre, located immediately to the west of the Regent, and the Seneca Theatre at 30-32 Fall Street. The significance of moving pictures in people's lives during the war cannot be underestimated. The Reveille paid tribute:

It is the moving picture shows that give us hope and cheer in these days of stress and uncertainty. And we are thankful for the number we have with us. They afford us relief from cheerless monotony, as well as of glimpses of the incarnate world and quiet our disturbed minds with a realization of things that were, but are not now. They do not affect us with fuel or coal shortages, with work-a-day suspensions, with non-heated homes, nor their attendant evils. Long live the picture shows! We have three of them and they are a solace to our dreams and a comfort in our sorrows. Reveille, January 25, 1918.

the theatre will be left about as it is now. The space below the stage will be used as a vulcanizing and tire repair department. A large display window will be placed on the level of the stage, and that part of the building will be used as a display floor.⁶³

The garage was open for business by January 1920; newspaper advertisements touted available services. George B. Graves, Bertrand G. Mackey and Frank G. Knox were directors of the corporation which operated the garage, Seneca Falls Garage, Inc. The company was capitalized at \$40,000 of which \$13,250 had been issued by the time of the garage's opening.⁶⁴ (See illustrations 55-57 for garage building and advertisements.)

A series of court actions soon followed, however, resulting in the closing of the garage. Asa B. Hilkert filed suit on February 21, 1921, in Seneca County Supreme Court against Bertrand G. Mackey, Frank G. Knox, their wives, and all tenants in the building. Hilkert's action was for the foreclosure of the contract of sale and purchase executed between him and the defendants on October 18, 1919. Apparently the Seneca Falls Garage, Inc. did not pay in full and obtain title to the building. The civil actions in the case occurred from February through June 1921. The supreme court in Canandaigua ordered on April 9 that the property be sold at public auction. Hilkert was the highest bidder, offering \$15,000 for the building at the auction on May 28, 1921. He thus received all right and title to the property. All of the personal property was

63. Reveille, October 24, 1919.

64. *Ibid.*, January 9, 1920. Bertrand Mackey lived with his wife Alice at 29 Chapel Street. He was listed in the 1921 Seneca Falls directory as a purchasing agent at Goulds. Auto mechanic Frank G. Knox and wife Mary G. rented a home at 40 Chapel Street. 1921 Seneca Falls Directory, pp. 93, 85.

purchased by Norman Boyce of Ovid, New York, who moved the equipment and tools to his garage in Ovid.⁶⁵

Asa B. Hilbert held onto the building until 1925. During that time various businesses became tenants. In addition to Dr. Albert J. Frantz and the New York Telephone Company office, other businesses named in Hilbert's suit included a Frank H. Smith and the Seneca Falls Athletic Association. The 1921 Seneca Falls directory did not mention Smith or the athletic association, but cited a lyceum hall and the Kibbey Repair Shop, in addition to Frantz and the telephone company offices, as being at 124-126 Fall Street. Frank H. Smith was a town clerk who lived at 112 Cayuga Street. Elliot B. Kibbey was a "mechanical eng., repair shop," who lived at 114 State Street. He leased a portion of the ground floor of the garage, installed machinery, and opened a machine repair shop by mid-August 1921. Information on the G.L. Ayers business mentioned in the Reveille article on October 24, 1919, is confusing, possibly due to an error in the newspaper. George L. Ayers operated Ayers Art store and picture framing business in the Fisher Theatre building, located next door to the old chapel. A G.L. Brady, electrician, however, had a business at the corner of Fall and Mynderse streets at least in 1921 and 1922. His newspaper advertisement mentioned a "Garage Storage Entrance," and he sold electrical supplies, bulbs, and Sinclair gasoline. It is possible the G.L. Brady business was in the garage building, rather

65. LIS PENDENS, Book 6, February 21, 1921, p. 207, SCCW; Civil Actions and Special Proceedings, Docket 1, p. 92, file 362, SCCW; Deed Book 146, June 9, 1921, p. 583; Reveille, June 10, 1921. The original deed of sale between Hilbert and Mackey, etc., occurring on October 18, 1919, was never recorded in the Seneca County deed books because the property was not paid for in full, and title received. Hilbert paid county taxes on the building in 1918 and 1919. No paid taxes were found for the years 1920 and 1921, but Hilbert resumed paying them in 1922. County tax, 1918, p. 62; *Ibid*, 1919, p. 76; *Ibid.*, 1922, p. 75. In 1918 the property was valued at \$10,000; this figure jumped in 1919 to \$14,000. Hilbert paid village taxes in 1918 and 1919; the Seneca Falls Garage, Inc. paid them in 1920 and 1921. The Regent Theatre was valued at \$9,000, while the garage was valued at \$13,000. Village tax, 1918, p. 52; *Ibid.*, 1919, p. 52; *Ibid.*, 1920, p. 112; *Ibid.*, 1921, p. 119.

than the George L. Ayers business. The reason for the discrepancies between the tenants mentioned in Hilkert's suit and those mentioned in the city directory is not known.⁶⁶

Huntington Ford and the 1923 Women's Rights Convention Anniversary

Fred L. Huntington established a Ford and Fordson sales and service garage at 38-40 Fall Street in March 1922. By December he moved the business to the corner of Fall and Mynderse streets. (See illustration 58 for Huntington Ford advertisement.) Asa B. Hilkert made substantial changes to the building to accommodate the new business. The Reveille detailed the changes: "The entrance in the center of the building has been removed and arranged into a very attractive sales floor. The car entrance will be on the Mynderse street side of the building."⁶⁷

In the course of the alterations in November 1922 the 1908 bronze commemorative tablet was removed from the building because a "large double doorway" was cut into the wall where the tablet had been placed. Hilkert reportedly was to turn the tablet over to the Seneca Falls

66. 1914 Seneca Falls Directory, p. 40; 1921 Seneca Falls Directory, pp. 69, 83, 100, 116; Reveille, August 12, 1921; April 8, 1921; *Ibid.*, November 4, 1921; *Ibid.*, March 3, 1922. The G.L. Brady/Ayers business was mentioned in the newspaper, but not in the city directory listing for 124-126 Fall Street or in the Hilkert suit.

67. Reveille, November 3, 1922; *Ibid.*, December 1, 1922; *Ibid.*, December 8, 1922. Fred L. Huntington, who lived with his wife Elsie S. at 138 State Street in 1927, and then at 59 Cayuga Street in 1977 with his second wife Emily Knight, opened his Ford, Fordson and Lincoln dealership in 1922 after having been with the firm of Matson & Huntington of Baldwinsville five years previously. Huntington bought out the business from F.G. Burton. He then changed to Pontiac sales before operating a Chrysler dealership from 1932 on. He served as mayor of the village of Seneca Falls from 1951 to 1953, and died in December 1977. "Fred L. Huntington Long-time Falls auto dealer dies," Finger Lakes Times, December 7, 1977, Archives Collection 37, Personal Papers Huntington, Box 10, Folder 7, SFHS; 1927 Seneca Falls Directory, p. 75; Reveille, March 3, 1922; *Ibid.*, March 11, 1927.

Historical Society, but for some unknown reason it ended up in the offices of the Reveille, where it was to stay until replaced on the building.⁶⁸

Fred Huntington's automobile dealership was on the ground floor of the old chapel when the 75th anniversary of the 1848 Women's Rights Convention was held in July 1923. According to the Reveille, "Much interest and much indignation had been aroused among the women of the nation because they have learned that the bronze tablet marking the Lyceum Hall as the cradle of equal rights for women, has been removed."⁶⁹

The National Woman's Party sponsored the anniversary celebrations.⁷⁰ Apparently, Asa Hilkert refused to replace the tablet or permit the National Woman's Party the use of the building for any kind of service. Hilkert had state authorities inspect the building and he refused responsibility for the use of the building's public hall until the state requirements were met.⁷¹

Fred L. Huntington, however, allowed the National Woman's Party, which had delegates present from all 48 states, the use of his showroom for their headquarters. Elizabeth Cady Stanton's desk and Susan B.

68. Ibid., November 3, 1922; Ibid., November 10, 1922; December 1, 1922.

69. Ibid., April 20, 1923.

70. The National Woman's Party was founded in 1917. Led by social reformer Alice Paul, the group was devoted to the cause of women's suffrage. Alice Paul drafted the first equal rights amendment for women, which she publicly read in Seneca Falls at the Presbyterian Church on Cayuga Street on July 21, 1923. The amendment was then introduced into Congress. "National Woman's Party," handbill, Pamphlet Collection, Folder "National Women's Party," SFHS.

71. Hilda Watrous, The County Between the Lakes A Public History of Seneca County, New York 1876-1982 (Waterloo, New York: Seneca County Board of Supervisors, 1982), pp. 349-350.

Anthony's rocker were placed there on display. Evidently Asa Hilkert was approached with offers to purchase the building in an effort to preserve it.⁷² (See illustration 59 of group displaying the tablet.)

Hilkert and his wife Louise sold the building to the Geneva Farm Improvement Corporation, Geneva, on July 27, 1925. Several of the same tenants remained in the building. In 1927 these included the telephone office, Dr. Albert Frantz, Fred L. Huntington's Ford dealership and E.W. Hudson and Son, a florist business, which opened its doors in the building in the autumn of 1922.⁷³

A 1925 Sanborn map provided details of the building's construction at the time of this sale. The building was identified as a garage with a concrete floor, steam heat and electric lights. The garage had a 40-car capacity with automobile storage on the second floor. A frame runway built on the north end of the building enabled automobiles to be driven to the second floor. A fire escape stood on the east side, leading into Mynderse Street. (See illustration 60.)

It is not known what the Geneva Farm Improvement Corporation was, or who ran the business. This group owned the former chapel/opera house for less than a year, selling it in February 1926 to Cornelius T. Lynch of Geneva, New York.⁷⁴

72. Ibid., p. 350; Seneca County Courier-Journal, July 19, 1923. For an account of the 1923 commemoration events, see Watrous, pp. 349-353.

73. Deed Book 153, July 27, 1925, p. 157, SCCW; 1927 Seneca Falls Directory, p. 162. Reveille, November 3, 1922. In 1927 Edward W. Hudson and his wife Grace E. lived at 83 E. Bayard Street. Their son Frederick A. and his wife Doris M. boarded at 81 E. Bayard. The florist business office was at 126 Fall Street, while the greenhouses were at 83 E. Bayard Street. 1927 Seneca Falls Directory, p. 73.

74. Deed Book 154, February 1926, p. 263, SCCW. No day of this sale was provided. Cornelius T. Lynch was born in West Stockholm in St. Lawrence County. In 1898 he graduated from Potsdam Normal School and served as a school teacher both there and in New York City for several years. He prepared for a career in business by attending night school (Continued)

Fred L. Huntington's automobile dealership stayed in the building throughout these years, with one major change. In March 1927 he ended his connection with the Ford company and began selling Oakland and Pontiac automobiles. The new cars were placed on display on March 11.⁷⁵ This business remained in the building until January 1928, when Huntington was forced to move because the building's new owner, Cornelius T. Lynch, signed a lease with another automobile concern. Huntington held a big sale and transferred his business to 201 Fall Street at the corner of Fall and Rumsey streets.⁷⁶

Now that the building was out of Asa B. Hilkert's hands, further commemoration of the 1848 Women's Rights Convention occurred. The 1908 bronze tablet was finally replaced on the old chapel east wall on October 25, 1928. More than 100 women from neighboring counties attended a lunch and ceremony, followed by the replacing of the tablet.⁷⁷ (See illustration 61 of the ceremony.) Another observance was made in 1932 when the New York State Department of Education placed a marker

74. (Cont.) and working in factories and stores during vacation months. In 1902 he became affiliated with a furniture firm in Fulton, New York and in 1905 he and his brother purchased the Bernard Borgman Furniture and Carpet Store on Exchange Street in Geneva, New York before buying the S. Nester property. Lynch lived at 469 S. Main Street in Geneva, and was a philanthropist who donated \$100,000 to Geneva General Hospital, in memory of his wife Elizabeth M. Lynch. Undated newspaper clipping, obtained by Elaine Brown. Village tax records for 1925 and 1926 list Asa B. Hilkert as paying taxes on the building. The 1926 tax also lists the Geneva Farm Land Improvement Corp. with the name C.T. Lynch, written in pencil. The building is listed as a "Stucco Building." Village tax, 1925, p. 58; *Ibid.*, 1926, p. 54.

75. Reveille, March 11, 1927. Apparently Fred Huntington disagreed with Ford's policy during this time of shipping their "Model T" automobiles to the dealers not on order, in an effort to raise money. Huntington refused the cars and switched companies. Telephone interview with Edwin Riggs Jr., Auburn, New York, April 8, 1986.

76. Reveille, March 11, 1927; *Ibid.*, January 27, 1928; *Ibid.*, February 10, 1928.

77. Watrous, p. 353; Reveille, October 19, 1928.

at the corner of Fall and Mynderse streets which cited the convention. The historic marker reads: "First Convention for Women's Rights was held on this corner 1848."⁷⁸

Seneca Falls Sales Co., Inc.

Cornelius T. Lynch owned the building until 1944. The tenants in the building changed several times during his ownership. In 1929 Dr. Alfred Frantz was still in the building, as was the New York Telephone office, but Fred L. Huntington's Pontiac dealership had been replaced by the Seneca Falls Sales Co., Inc. by February 1928, which offered sales and service for Ford automobiles and trucks. Ford automobiles were once again being sold in the building. This company's president was Glenn A. LaRowe, vice-president Russell Hornbeck, with secretary-treasurer Lawrence B. Lathrop.⁷⁹

By 1935 both Dr. Alfred Frantz and the New York Telephone office were out of the building. The only business left was the Seneca Falls

78. Ibid., p. 354; Seneca County Courier-Journal, December 29, 1932. Also marked was Elizabeth Cady Stanton's home on Washington Street.

79. 1929 Seneca Falls Directory, pp. 98, 128. All three of these men lived in Auburn, New York. Reveille, December 2, 1927; Ibid., November 25, 1927; Ibid., February 17, 1928. The street addresses for the building in this time period are confusing. The chapel/opera house building was located at 142-144 Fall, but in 1928 the newspaper advertisements for the Seneca Falls Sales Co., Inc. gave the address as 136 Fall Street. Meanwhile, Fred Huntington's business in 1928 is listed at both 136 Fall and 201 Fall, even though he had moved to the latter address in January 1928. By March 1929 the Seneca Falls Sales Co., Inc. was advertised at 126 Fall Street, the address of the chapel/opera house building having changed once again. See Reveille, March 30, 1928; Ibid., June 29, 1928; Ibid., March 8, 1929. The 1929 directory listed a Homestead Grill at the same address of 124 Fall Street, the complete address of the building being 124-126 Fall Street, but later directories list the grill at 125 Fall Street, which was on the south side of the street.

Sales Co., Inc.⁸⁰ This Ford dealership stayed at 124-126 Fall Street until at least 1958. Lawrence Lathrop Sr. founded a Ford dealership in Syracuse, New York in 1917. He went into partnership with Samuel Henderson in Auburn, New York, and when Fred Huntington switched automobile companies in Seneca Falls, Henderson was offered a dealership there. Henderson was not associated with H&L Ford for very long; Lawrence Lathrop became the sole owner of the business in Auburn and of the Seneca Falls Co., Inc. in Seneca Falls, which was a separate corporation. Throughout the years various family members became officers and shareholders in the corporation, including two of Lawrence Lathrop's sons-in-law, Charles Almy and Edwin Riggs Jr.⁸¹ (See illustration 62 of Seneca Falls Sales Company advertisement and illustrations 63 and 64 of the building.)

Throughout the 1930s and 1940s the officers of the company changed several times. In 1939 Glenn A. LaRowe was still president, but Lawrence B. Lathrop had moved to the vice-presidency.⁸² By 1947 Lawrence B. Lathrop was president of the company, Charles R. Almy was vice-president, Dorothy Ball was secretary and Edwin Riggs of Auburn was treasurer. At this time the company had opened the Seneca Tractor & Implement Co., Inc. in the building along with the Ford sales and service. After World War II both a school bus and taxi service operated out of the building.⁸³

Cornelius T. Lynch and his wife Elizabeth sold the former chapel/opera house to Henderson & Lathrop of 41 Market Street, Auburn,

80. 1935 Seneca Falls Directory, p. 93.

81. Telephone interview with Edwin Riggs Jr., Auburn, New York, April 8, 1986.

82. 1939 Seneca Falls Directory, no page provided.

83. 1947 Seneca Falls Directory, pp. 67, 174, 181, 183; Telephone Interview with Edwin Riggs Jr., Auburn, New York, April 8, 1986.

on November 22, 1944. At the time of the sale Lynch had a plat map made of the property which provided minor details of the building's construction.⁸⁴ (See illustration 65 for 1944 Lynch map.)

Even though no photographs of the building have been found for the c. 1932-1948 time period, it is probable the building was not substantially changed during these years of depression and world war. The major changes which turned the old opera house into the Regent Theatre were probably retained during this era. In 1948, however, the building once again underwent major renovations. A modernization program lasting a year was finally completed in January 1948, and the Seneca Falls Sales Co., Inc. held a special open house to celebrate. A full page advertisement in the Reveille touted a "new building" with 100,000 square feet of floor space and new equipment. (See illustration 67 for 1948 advertisement.) The building was completely redesigned. According to the newspaper:

Designed by Wallace P. Beardsley, Auburn architect, the building was constructed by M.S. Matterson, general contractor. The two story building of brick, concrete and steel has a frontage of 50 feet on Fall Street and of 100 feet on Mynderse Street. Display rooms on the first floor are floored with rubber tile, with walls and woodwork papered and painted in a warm beige.

Directly back of the display room is the lubrication, washing and minor repair sections of the service department. Designed for fast efficient service, this section handles ignition, carburator, fuel pump, lights and other minor repairs.

The second floor, connected with the ground floor by a large electric elevator, is designed for major motor overhauls, body repairs and painting. The paint booth in one corner is the most modern in the area and the body and frame repair equipment is of the latest design. Heavy and large parts are stored on the second floor with small parts and accessories on the first floor. The entire building is heated by steam with radiators in the display rooms and units blowers in the two service departments.⁸⁵

84. Deed Book 189, November 22, 1944, p. 361, SCCW; 1944 Map Book 12, p. 15, SCCW.

85. Reveille, January 16, 1948.

The scope of work included plumbing and heating, sprinkling system, masonry, fixtures and wiring, floor tile, wallpaper and paint, roofing installation, and installation of the elevator. The building's exterior essentially still retains the basic configuration wrought by these changes. At the time of this renovation the workers discovered a concrete booth, approximately 8' x 10', in the building's attic. This was the projection booth for the Regent Theatre.⁸⁶

The 1925 Sanborn map corrected to 1955 provided details of the building's configuration after these major changes. The three storefronts on the second floor south side were gone, with the space used for the automobile sales and service. Automobiles were still being stored on the second floor. (See illustration 66 for 1925 Sanborn map detail corrected to 1955.)

Centennial Observance of 1848 Women's Rights Convention

In 1948, during Henderson & Lathrop, Inc.'s ownership of the building, the centennial observance of the 1848 Women's Rights Convention was held. Various ceremonies were held around the nation. In Seneca Falls the centennial pageant, "Women Awakened," was presented in Mynderse Academy by 185 local residents; J. Seymour Chamberlain, the great-grandson of Henry Seymour and Jacob Chamberlain, two signers of the Declaration of Sentiments, was honored; and at the post office, first-day issue ceremonies honored a three-cent purple stamp bearing the likenesses of Elizabeth Cady Stanton, Carrie Chapman Catt and Lucretia Coffin Mott. First-day cancellations on the centennial covers depicted the scene in the Wesleyan Chapel 100 years before. Nora Stanton Barney, granddaughter of Elizabeth Cady Stanton, and Ann Lord Strauss, descendant of Lucretia Mott, addressed a mass meeting. During the

86. Telephone interview with Edwin Riggs Jr., Auburn, New York, April 8, 1986.

afternoon of July 19, 200 visitors toured the centennial headquarters, set up in the Seneca Falls Sales Co, Inc. building, the former Wesleyan Chapel.⁸⁷

The Seneca Falls Sales Co., Inc. Ford dealership continued to operate in the building; in 1954 Charles R. Almy was vice-president and general manager.⁸⁸ Henderson & Lathrop, Inc., sold the building to Edwin A. Riggs Jr. on September 28, 1956. This sale was done with the consent of the Henderson & Lathrop, Inc. stockholders. These were Lawrence B. Lathrop Sr., Lawrence B. Lathrop Jr., Doris L. Riggs and Florence M. Johnson. The property was conveyed to Edwin A. Riggs Jr. for \$45,430.03.⁸⁹ By 1956 the automobile dealership had changed to East Motors, operated by Cecil P. East, of Fayette, New York, another son-in-law of Lawrence Lathrop. East Motors did not stay in the building very long; the business moved by 1958 to a new location on Waterloo Road.⁹⁰ For approximately a year the Seneca Knitting Mills used the building to conduct some of its business after the mills were damaged by fire.⁹¹ Edwin A. Riggs Jr. then transferred the building back to Henderson & Lathrop, Inc. of Auburn on December 30, 1959.⁹²

87. Watrous, pp. 357-359; Reveille, July 16, 1948. Emily Knight MacWilliams chaired the Woman's Rights Centennial Committee in charge of these festivities. She is the great-great granddaughter of Wesleyan Methodist pastor Horace Barton Knight, and was later married to Fred L. Huntington, who operated the Ford dealership in the building during the 1923 women's rights observances. In winter 1986 she still resided in Seneca Falls.

88. 1954 Seneca Falls Directory, p. 310. Charles R. Almy lived with his wife Ruth and two children at 25 Maple Street. He also operated a used automobile lot on Waterloo Road.

89. Deed Book 273, September 28, 1956, p. 27, SCCW; *Ibid.*, p. 23.

90. 1958 Seneca Falls Directory, pp. 117, 335; 1961 Seneca Falls Directory, pp. 193, 534.

91. Telephone interview with Frank J. Ludovico, Las Vegas, Nevada, April 7, 1986.

92. Deed Book 292, December 30, 1959, p. 567, SCCW.

Seneca Falls Laundromat

A new tenant was in the building by 1961. The Seneca Falls Laundromat, a self-help laundry, had opened for business in the first floor space on the south end of the building. The laundry was owned by Jim Munger of Fairport, New York, who had a partner, Seneca Falls resident Frank J. Ludovico.⁹³ (See illustrations 68 and 69 of Seneca Falls Laundromat advertisements.)

In 1971 the building was sold again, from Henderson & Lathrop, Inc., to Frank J. Ludovico. Jim Munger did not wish to make this purchase, resulting in Frank J. Ludovico buying out Munger's shares in the business and becoming sole owner of the building.⁹⁴ In 1971, Ludovico had built 10 apartments on the building's second floor, put in the apartment windows and repaired the stucco. He retained the first floor garage space and freight elevator.⁹⁵

The National Park Service acquired the property from Frank J. Ludovico on April 2, 1985.⁹⁶ (See illustration 70 for a contemporary photograph of the building.)

Plans are for the National Park Service to establish a permanent park headquarters in the former Boyce Garage/village offices, next to the Assembly of God Church (the former Wesleyan Methodist Church on the

93. 1964 Seneca Falls Directory, pp. 133, 378; 1966 Seneca Falls Directory, pp. 336, 365, 399. Frank J. Ludovico was president and treasurer of FJL Inc., a contracting firm. His wife, Julia A., was vice president and secretary general of the firm, and clerk for Seneca Falls Laundromat. In 1966 they lived at 144 W. Bayard Street.

94. Deed Book 353, February 3, 1971, p. 776, SCCW; Telephone interview with Frank J. Ludovico, Las Vegas, Nevada, April 7, 1986.

95. Ibid.; Village tax, 1973, p. 53.

96. Deed Book 405, April 2, 1985, p. 947, SCCW.

corner of Clinton and Fall streets), in the same block as the Wesleyan Chapel building. A national architectural design competition will be held in 1987 to design a treatment for the Wesleyan Chapel remnants and the entire surrounding block facing Fall Street. The Wesleyan Chapel will thus serve as a place of contemplation and education, and once again be a notable visible symbol of the American women's rights movement.

RECOMMENDATIONS FOR FURTHER RESEARCH

Much more information about the Wesleyan Chapel congregation may be gleaned from the Wesleyan Methodist church records. Data on church hierarchy, how the trustees were elected and what their duties were, how pastors were hired, and how the trustees worked with the pastor in running church affairs can all be pulled from the church record books. Other information available is the amounts of pastoral salaries, and how the funds for these salaries were raised by the congregation. Church members' lives were governed by strict rules: conduct considered unchristian was reported and investigated, the offender was warned to improve her or his standing, and progress reports were made. Unchristian behaviors included intemperance, attending dances, playing cards or associating with "ungodly" people in saloons. Insights into women's roles within the church are also provided. A thorough congregational history could be written.

The search for a photograph or a sketch of the Wesleyan Chapel took many different avenues. Leading national repositories were queried or searched, as were local libraries and archives. None of the standard archives either possess or could locate a photograph of the Wesleyan Chapel, 1843-1871. In these times of short staffs and shorter budgets, one can only hope that local and national collections were searched thoroughly.

A suggestion to search through agricultural journals published in the Seneca Falls area in the 1840s was followed; several publications were searched in the Cornell University's Mann Library and Annex, but no notice of the convention was found. The periodicals searched were: Country Gentleman, American Agriculturist, Monthly Genesee Farmer, and the Monthly Journal of Agriculture.

Names of photographers which appeared in the Seneca Falls newspapers or directories from 1843-1871 were sent to the International

Museum of Photography at the George Eastman House in Rochester, New York, which has its entire collection organized by photographers' names. No photograph of the chapel was found, even though the provided names were searched by the George Eastman House staff.

Dr. Corinne Guntzel's suggestions to search the papers and scrapbooks of Elizabeth Cady Stanton's children were followed. No details of the chapel were found in the Harriot Stanton Blatch scrapbooks and Elizabeth Cady Stanton correspondence at Vassar College, Poughkeepsie, New York. References to an interior photograph of the Wesleyan Chapel appear in Harriot Stanton Blatch's correspondence to Seneca Falls historian Janet Cowing and photographer Grace Woodworth, located in the Grace Woodworth Collection at the Seneca Falls Historical Society. In 1921 Blatch wanted an interior shot of the chapel "as it was in 1848 with high pulpit and sounding board," for her book on her mother, which was soon to be published. Janet Cowing had told Blatch that such a photograph was available. From Grace Woodworth she received a copy of the interior with a "group of members of the Wesleyan Church," which was not the photograph Blatch wanted. Subsequent correspondence between Woodworth and Blatch, however, revealed that Blatch paid for a copy of the interior with the church members, and for a photograph of the 1908 bronze tablet placed on the wall of the Johnson Opera House. No further mention of the chapel interior photograph with the pulpit and sounding board was made. No such photograph was found among Woodworth's glass plate negatives at the Seneca Falls Historical Society. The Theodore Stanton Collection in the Mabel Smith Douglass Library, Douglass and Cook Colleges, New Brunswick, New Jersey, contained no useful information or photograph.

Several efforts were made to publicize a search for a photograph. The Stanton Foundation in Seneca Falls held a contest in the fall of 1984; photographs of the second Wesleyan Methodist Church, on Clinton and Fall streets, were turned up; no photographs of the chapel appeared. USA Today was contacted regarding printing an article about the search, but its response was negative. The newspaper believed such an article

was a too-narrowly focused "woman's issue" piece which did not possess enough appeal for a broader readership. An article about the search did appear in the American Association for State and Local History journal History News. An additional notice of the search appeared in Picture Scope, the Quarterly Journal of the Picture Division, Special Libraries Association, in spring 1986.

An effort to contact descendants of the Hunt family was made. Elaine Brown discussed the issue of a Wesleyan Chapel photograph with several family members, but she was unsuccessful in obtaining any information.

Inquiries were also sent to several photograph collectors' organizations. No response was received, except from the Granger Collection, which possessed a twentieth century drawing of the 1848 Women's Rights Convention. Others contacted were the American Photographic Historical Society, Inc.; Delaware Valley Photographic Association; National Stereoscopic Association; the Photographic Historical Society and the Photographic Historical Society of New England, Inc.

A photographer, only half-jesting, gave the advice that everything in the world has been photographed once; the key was to find the photograph. If this is true, the search for a photograph of the Wesleyan Chapel should continue.

APPENDICES

APPENDIX A: DETAILS OF WESLEYAN CHAPEL INTERIOR

<u>Church Record Book</u>	<u>Date</u>	<u>Chapel Furnishing/Action Taken</u>
1	4/3/1848	indebtedness for stove; paints \$22.00
1	4/16/1855	fee of \$5.00 for use of chapel; committee appointed to employ a sexton and to provide fuel and lights, also to clean the house
1	9/10/1857	committee appointed to obtain two stoves; raising "twen one" dollars towards repairing the church
2	9/6/1858	gas bill \$4.90; for book \$.32; bill for introducing "gas in this meeting house" is \$100.00; J.A. Swallow burned receipts and expenditures in "repairing this house"
2	10/4/1858	gas bill for August \$2.65; coal bill \$4.50
2	11/1/1858	coal bill \$2.86; collection of \$27.25 to apply on carpet bill
2	12/6/1858	October gas bill \$4.25; \$18.25 paid on carpet bill; Sabbath afternoon prayer meeting granted use of the prayer-room by choir for rehearsal on Friday evenings, lights and fuel included
2	1/3/1859	gas bill \$2.65; glass & putty \$.38; committee appointed to "supply the Pulpit the year to come"; arrangements made for building the fires during the week for the extra meetings to be held
2	2/6/1859	baptism at the altar
2	2/13/1859	baptism at the altar
2	2/21/1859	Brother Van Tassel made claim for "extra services in taking care of church"; December gas bill \$3.25; January gas bill \$8.05
2	3/13/1859	baptisms at the altar

2	4/4/1859	February gas bill \$10.85; March gas bill \$8.50
2	4/17/1859	baptism at the altar
2	5/9/1859	coal bill \$2.25
2	5/24/1859	baptism at the altar
2	8/8/1859	April coal bill \$4.25; July gas bill \$9.50
2	9/15/1859	volunteers to take care of church
2	10/10/1859	gas bill \$6.95
2	11/14/1859	paid for "Coke" \$2.00; alcohol \$.44; coal \$2.31; T.J. Crosby, Sexton, for two weeks \$3.00
2	12/12/1859	wood \$2.00; L.F. Giddings six weeks as sexton, \$9.00
2	1/9/1860	paid Lyman Giddings \$7.00; gas bill \$13.00; carting \$.38
2	2/13/1860	coal \$.57; Giddings \$3.00; coal, \$4.00; trustees authorized to lower the pulpit two steps
2	3/14/1860	coal \$6.50; carting \$.19; Giddings \$1.50
2	4/9/1860	Giddings \$6.00; coal \$2.50
2	5/14/1860	Giddings \$4.63; gas pipe \$.75
2	7/9/1860	L. Giddings \$2.24
2	11/13/1860	broom \$.38; coal \$2.45; Giddings \$3.00; scuttle \$.68; gas bills \$16.85
2	8/13/1860	July 15 Giddings \$2.16; July 27 Giddings \$1.00; August 5 Giddings \$2.00; August 12 Giddings \$.79
2	1/14/1861	carting \$.25; alcohol \$.30; gas \$10.00
2	2/4/1861	gas overpaid \$1.50; coal & casting \$4.08; alcohol \$.30
2	3/4/1861	coal \$5.50

2 4/1/1861 brom [sic] \$.25; Van Tassel \$2.30; ditto \$5.58; coal \$.88

2 6/3/1861 volunteers sought to clean the church

2 7/8/1861 Birney \$.75; books \$.10; Mann & Miller \$10.00; moved that Br. Giddings be invited to "take charge of the house this month"

2 8/5/1861 lumber \$2.50; carting \$.18; nails \$.36; Birney \$2.00; express on melodian \$1.10

2 9/2/1861 screws \$.30; Birney \$1.25; Van Tassel \$1.00

2 11/4/1861 paid for "Repr Pipe" \$7.13; Backman \$2.50; coal & coke \$3.88; wood \$1.00; Crosby sexton \$1.00

2 12/2/1861 paid Crosby as sexton \$5.00; bill of \$1.93 for toping out chimneys

2 1/6/1862 Butts \$1.93; Crosby \$3.00; coal \$3.00

2 2/4/1862 making box \$2.54; coal \$3.00; Mr. Sitzenberger received permission to lower the platform in gallery at his own expense; services acquired to tune the melodian

2 3/3/1862 February for Crosby \$1.00; coak [sic] \$.30; paid note to Griswold \$16.00; coak [sic] \$.20; coal \$3.00; March for Crosby \$2.00

2 4/7/1862 tuning melodian \$2.00; Birney \$1.25; Crosby \$5.50; broom \$.18

2 6/2/1862 communion service \$.24; May 11 Crosby \$2.00; May 19 Crosby \$3.00

2 7/7/1862 Crosby \$5.00; fix melodian \$.25

2 11/3/1862 August Crosby \$3.50; September cleaning church \$2.00; September Crosby \$5.00; October for coke \$2.25; paid sexton \$15.00

2 12/1/1862 coal \$3.00; broom \$.25

2	12/8/1862	Brother Bell empowered to have stoves repaired
2	1/5/1863	settling insurance matter; repairing stove; glass & putty \$.30; coal \$3.00
2	1/19/1863	committee appointed to draw a draft of the church seats and recommend plan for renting them
2	2/2/1863	sexton \$4.00
2	3/2/1863	Carter \$3.00; plates \$.46
2	4/6/1863	gas bill presented for \$4.80; paid for painting numbers for seats \$3.00; coal \$3.45; tacks \$.18
2	6/1/1863	paid sexton on salary \$10.00
2	7/6/1863	printing \$1.75; trustees requested to procure a "suitable person" to take care of the church
2	8/3/1863	church seal \$2.00; Carter \$10.00; gas bill \$3.60
3	9/7/1863	stove sold \$2.37; Carter \$4.00; broom \$.25
3	10/5/1863	Norcott \$3.38; Carter \$5.00; coal \$7.00; for record book \$.60
3	11/9/1863	coal \$.50; coak [sic] \$.13; broom \$.25; gas bill \$6.00
3	12/7/1863	Carter \$1.50; Crosby \$3.00; Butts \$4.00; Crosby \$1.00; Crosby \$6.00
3	1/4/1864	Crosby \$6.50; Crowell \$5.00; Butts \$5.00; coke \$.13; McCoy fixing gate \$.50; motion to procure new stoves
3	2/1/1864	Crosby \$2.00; wine \$.75; Crosby \$3.00; coal & coke \$5.25
3	3/7/1864	coke \$1.00; Crosby \$5.00
3	4/4/1864	Crosby \$4.00; gas bill to January 11 \$11.20; Miller fixing stove pipe \$18.31

3	5/2/1864	sold "H Books" \$1.85; paid Holten for Deed \$5.00
3	6/13/1864	Crosby \$12.66; carting coal \$.13; Collver \$1.00; Birney for fixing burners \$2.38
3	8/1/1864	brush \$1.75; Crosby \$9.84; gas bill \$20.80; wine \$.75; coal \$13.13; hand books \$76.98; trustees requested to buy one ton of coal; choir empowered to draw \$8.00 for books
3	10/11/1864	Butts \$5.00; gas bill \$7.47; coke \$1.00
3	11/21/1864	alcohol \$.25; hymn book \$.52; R.F. Butts \$9.50
3	12/7/1864	committee appointed to repair gas lights and sidewalks; wood \$6.00; glass & putty \$.70; repairing windows \$.50; sexton \$1.50
3	1/2/1865	December Crosby \$2.00; sawing wood \$1.00; coke \$2.00; January Crosby \$6.00
3	3/6/1865	paid Birney repairing gas pipe \$11.15; wood \$2.00; February Crosby \$7.00; grate & lining for stove \$1.08; gas bill \$7.89; March Crosby \$6.00
3	5/8/1865	wood \$2.00; April Crosby \$6.50; gas bill \$8.72; lumber \$.35; May Crosby \$6.00; nails & alcohol \$.35
3	6/5/1865	stove pipe \$7.57; for Pass [?] book \$.25; wine \$1.00
3	7/3/1865	festival money appropriated to pay sexton, gas bill, and floating debt
3	8/7/1865	June 11 Crosby \$6.00; July 11 Crosby \$10.00; August Crosby \$8.50; gas bill \$7.47; possible appropriation of festival fund for an organ
3	9/11/1865	trustees instructed to purchase organ at price not exceeding \$400.00
3	10/2/1865	coal \$20.00; Penoyer \$3.50; express \$1.10; September Crosby \$6.00; October Crosby \$3.50

3	11/6/1865	paid for pail \$4.40; Crosby for walk \$23.43; Somers for printing \$4.00; ? for printing \$2.50; alcohol \$.10; motion that melodeon be sold to the highest bidder
3	12/4/1865	freight on organ \$4.95
3	1/8/1866	gas bill \$7.06; Crosby \$15.00
3	2/12/1866	coke \$1.80; Crosby \$4.00; wood \$5.00; coal \$13.50
3	5/7/1866	coal \$6.25; broom \$.38; pass [?] book \$.12
3	8/6/1866	May sexton \$20.00; Pew & Molten \$4.25; building walk \$6.00; sexton \$40.00; lumber \$19.08; gas bill \$61.23; broom \$.38; C.B. Howe \$100.00
3	9/10/1866	sexton \$10.00
3	10/1/1866	sexton \$7.00
3	11/12/1866	sexton \$9.00
3	12/3/1866	trustees moved to have Christmas Tree and charge adults \$.10 admission; broom \$.40; sexton \$5.00; stove & pipe \$49.72; William Smalley for wine \$3.88
3	1/21/1867	wood \$6.50; coal \$8.50; sexton \$14.00; repairing walk \$.37
3	3/11/1867	sexton \$5.00; 1 ton coal \$9.50; drawing coal \$.63; sexton \$12.00
3	5/13/1867	coal \$3.00; sexton \$7.50
3	6/2/1867	sexton \$4.50; Mr. Lamb \$1.25; Anna Rumsey appointed to committee to superintend cleaning the church
3	7/1/1867	broom \$.35; Bradley Cleaning \$3.75; Mrs. Rumsey \$5.25; for dirt \$15.75; sexton \$6.00; whitewashing \$.75
3	9/2/1867	gas bill \$52.18; sexton \$7.50; brooms \$.70; sexton \$6.00
3	9/30/1867	brooms \$.70; Conference \$10.29; sexton \$7.50

3	11/1867	coal \$7.50; cleaning church \$4.00; clean stoves \$2.00; sexton \$7.50
3	12/2/1867	sexton \$7.00
3	2/3/1868	coal \$9.00; stove grate \$1.00; January sexton \$8.50; coal \$9.00; coal hod \$1.25; February sexton \$8.50
3	3/2/1868	wood \$7.00; Sangworthy & c \$14.48; sexton \$6.50
1	3/23/1868	Brother Bellows to have the gas pipe in the church enlarged, and changes in order to get a sufficient light for the church
3	4/6/1868	coal \$5.50; sexton \$7.50; broom \$.35
1	4/10/1868	trustees discussed subject of repairs and remodelling of the church
3	5/4/1868	sexton \$6.50; coke \$1.50
3	6/1/1868	sexton \$9.00; resolution to clean the church, committee of Sisters Rumsey & Freeland appointed to superintend the work, and money collected; Brother Lyle appointed to superintend the fixing of the windows
3	7/13/1868	Mary Freeland \$5.56; gas bill \$63.80; sexton \$7.50
3	8/3/1868	Cynthia Carter \$.80; broom \$.35; sexton \$6.00; resolution to raise money to make repairs as necessary for the "preservation of the building and the fence"
3	9/14/1868	sexton \$9.00; insurance \$22.50; Sabbath School received permission to hang the maps up in the church permanently
3	10/12/1868	coal \$8.00; wood \$2.25; Mrs. King \$.50; repairs stove \$.50; sexton \$6.00
3	11/9/1868	coke \$2.50; sexton \$6.00
3	12/14/1868	repairs walk \$2.00; broom \$.45; carting \$.25; glass & putty \$.52; sexton \$7.50

3	1/11/1869	fixing stove \$.95; coal \$10.00; sexton \$9.00
3	2/8/1869	sexton \$6.00; shovelling snow \$1.00
3	3/8/1869	coal \$5.00; carting \$.25; wood \$2.25; sexton \$6.50; moved that \$8.75 be paid for gas burners for the pulpit
3	4/12/1869	coal \$4.50; sexton \$8.00
1	8/10/1869	personal property taken from church; one sofa, one mahogany mable top table and four sofa chairs
1	9/10/1869	classroom locked on Sabbath; chairman of board of trustees instructed to purchase furniture for the desk and altar at cost not exceeding \$60.00
4	10/3/1870	Miss Armstrong hired to play organ at \$1.00 per Sabbath
4	7/3/1871	voted to pay for hymn book and take up collection for same

Note: Many of the entries in the four First Wesleyan Church record books are difficult to read or interpret. Various people, some of whom were members of the congregation, were paid for some type of services rendered, although these services were not detailed. Handwriting was sometimes difficult to decipher, as was the meaning of several words. Thus this list of church expenditures, as it pertains to the chapel, is not inclusive.

APPENDIX B: APPEARANCE OF WESLEYAN CHAPEL, JULY 1848

Few details are available concerning the Wesleyan Chapel's appearance on the dates of the women's rights convention, July 19 and 20, 1848. Since the structure was only five years old at the time of the convention, references to its appearance at its dedication probably held true.

The chapel was brick, on a "good site," yet was neat and plain. Three dimensions were cited: 43' x 64', 44' x 64' and 60' x 40'. Fall street was not yet paved, but a sidewalk did exist on the west side of Mynderse Street along the chapel lot. Inside the chapel, galleries were on three sides and furniture included pulpit slips and an altar. Two rooms probably existed in addition to the main chapel--a vestry and a classroom.

Reminiscences of the convention proceedings mention windows, "high from the ground," and doors which could be barred by bolts on the inside. The gallery was again mentioned, as well as "dusty" windows, wooden benches or pews, and a platform with a desk and communion table. The only reference found concerning possible interior treatment comes from a church record book: on April 4, 1848 the trustees spent \$22.00 on "paints."

All other known details of the chapel's appearance, including furniture, gas fixtures, outbuildings and fences are available only for later time periods.

APPENDIX C: CHRONOLOGY OF EVENTS HELD IN WESLEYAN CHAPEL

This is a partial listing of events occurring in the Wesleyan Chapel, taken from the Seneca Falls Democrat, American Reveille, Seneca Falls Reveille, Seneca Free Soil Union and the Seneca County Courier, 1843-1871.

October 14, 1843--Wesleyan Chapel dedication

March 14, 1848--Union Temperance Society meeting

June 15, 1848--Freemen of Seneca Falls met to discuss presidential nominations

July 19 and 20, 1848--Women's Rights Convention held

January 26, 1849--G.W. Bungay delivered temperance address

July 4, 1851--Fourth of July celebration held, with address on temperance delivered by Thurlow W. Brown, and a reading of the Declaration of Independence. A balloon ascension occurred nearby.

February 2, 1852--Seneca Falls Temperance Society meeting

March 7, 1855--Elizabeth Cady Stanton gave lecture on "Common Schools"

March 19, 1855--Public meeting on temperance held

May 23, 1855--Reverend Antoinette L. Brown lectured on the Kansas Territory elections

November 1855--Thanksgiving Day services held

September 22, 1856--Frederick Douglass spoke in favor of Republican presidential candidate John C. Fremont

October 13, 1856--Republican meeting in support of John C. Fremont

December 14, 1857--Citizens meeting held to consider relief of the village poor

December 31, 1858--New Year's services held

January-February 1859--Series of revival meetings held

July 3, 1859--Reverend Horace Barton Knight delivered oration

October 3, 1859--Seneca Falls Total Abstinence Temperance Society held meeting

November 1859--Reverend Horace Barton Knight preached Thanksgiving sermon

December 4, 1859--Reverend W.W. Clayton of Auburn preached sermon on "Character of Christ"

December 24, 1859--Sabbath School children assembled at the chapel to receive presents from the Christmas Tree. Reverend Horace Barton Knight took the gifts from the tree and distributed them.

December 26, 1859--Reverend J.N. Crittenden delivered temperance lecture

April 26, 1860--The Rochester Conference of the Wesleyan Denomination in session "in this village"

July 13, 1862--Reverend John P. Betler of Syracuse gave sermons

October 26, 1862--Quarterly Meeting held, with "Love Feast" and administration of Lord's Supper

December 24, 1862--Sabbath School distributed presents on Christmas Tree

February 14, 1863--Meetings held for the purpose of renting the seats

March 11, 1864--Reverend Dr. Eddy of the Presbyterian Society lectured before the S.F.M.I. Association on "Republics - Their Immunities and Mission"

July 16, 1865--Reverend William W. Lyle installed as pastor

September 24, 1865--Reverend Lyle delivered abolition lecture on "the rights, duties and responsibilities of our Union soldiers"

April 13, 1866--Reverend Lyle started a course of lectures on astronomy and natural philosophy

April 30, 1866--Annual meeting for pew rental held

May 14, 1866--S.M. Hewlett delivered lecture on temperance, admission \$.25

October 28, 1866--Reverend Lyle gave lecture on "The Moral Aspects of the Present Political Issues"

January 20, 1867--Miss Owen, of Ohio, delivered lecture on temperance

- September 13, 1867--Rochester Conference in session, 40-50 clergy in attendance
- December 8, 1867--Reverend Amory H. Bradford, son of Reverend B.F. Bradford, former pastor at chapel, preached Sunday services
- December 20, 1867--Mrs. A.T. Randall gave temperance readings, admission free
- December 24, 1867--Celebration of Christmas Eve with Christmas Tree at chapel, "richly laden with suitable presents for the children, and friends in general," admission \$.10
- March 17, 1868--Temperance addresses delivered by Reverend Silas Ball, Grand Worthy Chief Templar of New York, and Reverends Krum and Lyle, in concurrence with Convention of Good Templars held in Seneca Falls
- April 24, 1868--Annual pew rental
- May 8, 1868--Dr. Miller began course of lectures on "Anatomy and Physiology," first lecture free, subsequent lectures \$.15. According to the Reveille, "His illustrations are pronounced very fine, and his models, skeletons and manikins the best of the kind made."
- May 22, 1868--Dr. Miller concluded course of public lectures with talk on the "Temperaments." "A lecture to ladies only will be given at the Church tomorrow afternoon."
- December 25, 1868--Holiday presents distributed from Christmas Tree
- May 14, 1869--Annual pew rental
- October 3, 1869--Reverend L.N. Stratton, of the Syracuse Conference of the Wesleyan Methodist Church, preached services
- December 31, 1869--Watch Night meeting held by church members
- February 6, 1870--Reverend Mr. Salisbury, of Wayne County, preached Sunday services
- February 13, 1870--The 64th quarterly meeting of the Seneca Falls Sabbath School Association held
- April 27, 1870--Annual session of the Rochester Conference of the Wesleyan Methodist Connection held at the chapel
- May 16, 1870--Free lecture delivered to "ladies of Seneca Falls" by Susan Everett, M.D., of Columbus, Ohio, on "The ill health of American women--its cause and cure"

November 24, 1870--Thanksgiving services held at 11 o'clock by Reverend Mr. Salisbury

February 15, 1871--Miss S.E. Bucklin, author of "In the Hospital and Camp," a record of her experiences as a hospital nurse during the war, delivered lecture, admission \$.25

November 30, 1871--Thanksgiving services held

December 25, 1871--Sunday school had a Christmas Tree

APPENDIX D: BIOGRAPHIES OF FIVE WOMEN WHO ORGANIZED
THE 1848 WOMEN'S RIGHTS CONVENTION HELD IN
WESLEYAN CHAPEL

MARTHA COFFIN PELHAM WRIGHT (December 25, 1806--January 4, 1875)

Martha Wright was born in Boston, Massachusetts, and was the sister of Lucretia Coffin Mott. She attended the Kimberton Boarding School near Philadelphia and in 1824 married army captain Peter Pelham. Martha was then expelled from the Society of Friends because she married out of meeting. A child, Marianna, was born to them in August 1825. After Pelham's death, Martha moved with her mother to Aurora, New York, in 1827 and taught school. In 1829 she married Philadelphia lawyer David Wright and gave birth to six children. She lived in Aurora until 1839, when she moved to Auburn, New York, with her husband.

After she helped plan the 1848 Seneca Falls women's rights convention with her sister Lucretia, Martha stayed involved with the movement. She served as secretary to the 1852 Syracuse convention, was vice-president of the 1854 Philadelphia convention, was elected president of conventions in Cincinnati, Saratoga, and Albany in 1855, and presided over the 1860 convention in New York City.

Martha Wright's loyalties remained with Susan B. Anthony and Elizabeth Cady Stanton during the division in the women's rights movement following the Civil War, and she helped organize the American Equal Rights Association and the National Woman Suffrage Association. In 1874 she was elected president of the latter organization. She died at age 68, and is buried in Auburn, New York.

Source: Notable American Women A Biographical Dictionary, 1971 ed., s.v. "Wright, Martha Coffin Pelham," by Paul Messbarger.

LUCRETIA COFFIN MOTT (January 3, 1793--November 11, 1880)

Lucretia Coffin Mott was born on Nantucket Island of Quaker parents, Anna Folger and Thomas Coffin. She attended public school in Boston for several years before entering the Friends' boarding school at Nine Partners near Poughkeepsie, New York. After four years of study and teaching she moved to Philadelphia, where she married teacher James Mott on April 10, 1811. They had six children.

After the death of an infant son in 1817 she began speaking in meeting. She was soon made an "acknowledged minister" in the Society of Friends. Yet her liberal views and sympathies with Elias Hicks led to her affiliation with the Hicksite group in the 1820s reorganization within the Society of Friends.

She was noted for her preaching skills and traveled extensively to speak at Quaker meetings on reform topics, including temperance, women's rights and abolition. Her chief interest remained the abolition of slavery even though she was not accepted at the World's Anti-Slavery Convention in London in 1840 because of her sex, which led to her subsequent organizing of the 1848 Women's Rights Convention. In 1833 she helped organize the American Anti-Slavery Society in Philadelphia, and was president of the Philadelphia Female Anti-Slavery Society. In 1837 she helped organize the Anti-Slavery Convention of American Women. Her abolitionist views were met with opposition from many Quakers and efforts were made to take away her ministry and membership.

After the 1850 Fugitive Slave Law was passed she and her husband sheltered runaway slaves in their home. After the Civil War she worked for the rights of freedmen. Lucretia Coffin Mott continued preaching and working in different reform movements until her death at her farm, "Roadside," outside Philadelphia.

Sources: Dictionary of American Biography, 1962 ed., s.v. "Mott, Lucretia Coffin," by Mary Wilhelmine Williams.

Famous American Women, 1980 ed., s.v. "Mott, Lucretia Coffin."

See also: Bacon, Margaret Hope. Valiant Friend The Life of Lucretia Mott. New York: Walker and Company, 1980.

Clemmer, Mary. "Lucretia Mott." In Our Famous Women An Authorized Record of the Lives and Deeds of Distinguished American Women of Our Times, pp. 462-497. First Published 1883; reprint ed., Freeport, New York: Books for Libraries Press, 1975.

Cromwell, Otella. Lucretia Mott. Cambridge, Massachusetts: Harvard University Press, 1958.

ELIZABETH CADY STANTON (November 12, 1815--October 26, 1902)

Elizabeth Cady Stanton was born in Johnstown, New York, the daughter of Judge Daniel Cady and Margaret Livingston Cady. She received her education at home, at the Johnstown Academy and at Emma Willard's Troy Female Seminary, where she graduated in 1832. She gained a working knowledge of the legal disabilities of married women from her father, and became interested in abolition through her cousin, Gerrit Smith, and his daughter, Elizabeth Smith Miller.

In 1840 she met and married prominent abolitionist Henry Brewster Stanton, and spent a portion of her honeymoon attending the World's Anti-Slavery Convention in London. In the following years the couple lived in Johnstown and Boston, where Stanton associated with exponents of various reforms. After a move to Seneca Falls in 1847 she circulated petitions favoring the passage of a married women's property rights bill, and organized the 1848 Women's Rights Convention.

In 1851 she met Susan B. Anthony, from nearby Rochester, New York, and for the next 50 years she campaigned for various reforms but devoted ever increasing time to women's rights. Stanton, the orator, theorist and writer, complemented Anthony's skills as an organizer and tactician. She wrote hundreds of letters, articles and essays, as well as Anthony's and her own speeches. She lectured about family life and children on the lyceum circuit, promoted liberalized divorce laws, coedited

the weekly Revolution, compiled the first three volumes of History of Woman Suffrage and wrote the Woman's Bible.

During the Civil War she turned her attention to abolition, and helped organize the Women's Loyal National League. After suffrage was granted to black males she returned to the cause of women's suffrage, and in May 1869 she helped organize the National Woman Suffrage Association. She served as president for the 21 years of the association's existence. Her 1878 draft of a federal suffrage amendment was basically the wording adopted in 1919. She became the first president of the new National American Woman Suffrage Association in 1890. Her death came in New York City at age 87.

Sources: Dictionary of American Biography, 1964 ed., s.v. "Stanton, Elizabeth Cady," by Mary Wilhelmine Williams.

Famous American Women, 1980 ed., s.v. "Stanton, Elizabeth Cady."

See also: Banner, Lois W. Elizabeth Cady Stanton A Radical for Woman's Rights. Boston: Little, Brown and Company 1980.

Bullard, Laura Curtis. "Elizabeth Cady Stanton." In Our Famous Women An Authorized Record of the Lives and Deeds of Distinguished American Women of Our Times, pp. 602-623. First published 1883; reprint ed., Freeport, New York: Books for Libraries Press, 1975.

DuBois, Ellen Carol., ed. Elizabeth Cady Stanton Susan B. Anthony Correspondence, Writings, Speeches. New York: Schocken Books, 1981.

Griffith, Elizabeth. In Her Own Right The Life of Elizabeth Cady Stanton. New York: Oxford University Press, 1984.

Lutz, Alma. Created Equal A Biography of Elizabeth Cady Stanton. New York: The John Day Company, 1940.

Nies, Judith. Seven Women Portraits From the American Radical Tradition. New York: The Viking Press, 1977.

Stanton, Elizabeth Cady. Eighty Years and More. New York: Schocken Books 1971.

In studying Elizabeth Cady Stanton's career subsequent to the 1848 Seneca Falls convention, one must consider Stanton's friend and co-worker Susan B. Anthony. Their legendary 50-year friendship was an

essential factor in the campaign for women's rights and woman suffrage. For biographical information on Susan B. Anthony see:

Anthony, Katharine. Susan B. Anthony Her Personal History and Her Era. New York: Russell & Russell, 1975.

Harper, Ida Husted. Life and Work of Susan B. Anthony. 3 vols. New York: Arno & The New York Times, reprint ed., 1969.

Stanton, Elizabeth Cady. "Susan B. Anthony," pp. 53-74. In Our Famous Women An Authorized Record of the Lives and Deeds of Distinguished American Women of Our Times. First Published 1883; Freeport, New York: Books for Libraries Press, 1975.

JANE MASTER HUNT (June 6, 1812--November 28, 1889)

Very little is known of Jane Master Hunt, a Quaker from Philadelphia. In 1845 she married Richard P. Hunt, a Waterloo Quaker entrepreneur. He was 15 years her senior and had a family from three previous marriages. Hunt bore three children and survived her husband by 33 years.

In July 1848 she invited Elizabeth Cady Stanton to visit her home and meet Lucretia Mott, visiting from Philadelphia. She attended the convention in Seneca Falls and signed the Declaration of Sentiments. She and her husband remained active in the progressive Quaker community, but details of her activities are scarce and scattered.

Sources: U.S. Department of the Interior, National Park Service, Women's Rights National Historical Park, New York, "Special History Study," prepared by Sandra S. Weber, Denver Service Center, Denver, Colorado, 1985.

Correspondence with Dr. Judith Wellman

MARY ANN MCCLINTOCK (1800-1884)

Very few details are known of Mary Ann McClintock's life. She and her husband Thomas left Philadelphia for Waterloo either in 1835 or 1836, and lived there until 1856 or 1857. Thomas McClintock ran a drugstore in a building he rented from Richard P. Hunt, then married to Thomas' sister Sarah.

Both the McClintocks were active in radical Quaker activities in Philadelphia and supported the abolition movement. Mary Ann McClintock may have been an acknowledged Quaker minister. She and her husband were affiliated with the Hicksite Quakers, and she served as assistant clerk for the Women's Yearly Meeting from 1839 to 1841. In 1848 she broke away from the Hicksite Quakers and helped form the even more liberal Congregational or Progressive Friends, who believed in practical reform. Her husband Thomas wrote the guidelines for the new society.

Of Mary Ann McClintock's five children, four daughters attended the 1848 Women's Rights Convention. The two eldest, Mary and Elizabeth, signed the Declaration of Sentiments along with their parents. Mary was appointed secretary for the proceedings and even delivered an address. Elizabeth delivered an address; she also prepared a report of the proceedings with her mother. Mary Ann and Elizabeth McClintock both attended the Rochester conference held a few weeks later.

The family remained active in Progressive Quaker Society throughout the 1850s, before they returned to Philadelphia. Mary Ann McClintock died there in 1884 at age 84.

Source: U.S. Department of the Interior, National Park Service, Women's Rights National Historical Park, New York, "Special History Study," prepared by Sandra S. Weber. Denver Service Center, Denver, Colorado, 1985.

APPENDIX E: JOHNSON HALL AND OPERA HOUSE EVENTS

This is a partial list of activities occurring in the Johnson Hall and opera house, taken from the Seneca County Journal, Seneca County Courier, Seneca County Courier-Journal, Ovid Bee, The Evening Herald, Seneca Falls Reveille and miscellaneous handbills. All the years of the Johnson Hall and opera house operations are not covered; this list is offered as representative of events held from 1872-1915.

Johnson Hall

- October 11, 1872--Honorable William Dorsheimer of Buffalo spoke on political issues of the day
- October 14, 1872--General Caldwell of Maine made "ranting Radical" speech
- October 22, 1872--Catholic Society fair commenced
- March 9, 1873--Temperance meeting held, under auspices of the Seneca Falls Tent of Rechabites, preached by Reverend G.A. Eggleston of Auburn
- March 30, 1873--Temperance meeting held, under auspices of the Seneca Falls Tent of Rechabites, preached by Professor Wilcoxon of Syracuse University
- April 14, 1873--German public ball held
- April 18, 1873--Young ladies of Seneca Falls act and sing in an opera
- December 26, 1873--"Pepita! The Gipsy Girl of Andalusia!" a tragic burlesque opera in five acts presented
- August 2, 1874--Temperance meeting addressed by Colonel Hoy of Albany
- December 30, 1873--Christmas supper for the Trinity church Sunday school held
- February 7, 1875--William C. Day and others address temperance meeting
- February 14, 1875--Silas Hewitt addressed temperance meeting
- April 4, 1875--Temperance meeting held

- April 5, 1875--Spelling school held
- April 25, 1875--Temperance meeting held, addressed by Reverend V.F. Bolton of Bearytown
- November 20, 1875--Dr. P.W. Emens of Syracuse began series of six or seven lectures on physiology and hygiene. Subject of first free lecture: "Sickness, its cause and cure"
- November 21, 1875--Dr. P.W. Emens of Syracuse addressed temperance meeting
- November 29, 1875--Professor W.R. Jones of Auburn organized singing class
- April 20, 1876--Masquerade given by the U.R. of D.
- November 5, 1877--St. Peter's Church Choir gave grand concert
- June 14, 1878--Women of the Baptist society hold strawberry and ice cream festival
- August 28, 1879--Women of the Wesleyan Methodist Church hold peach and ice cream festival
- October 20, 1881--Professor Parker taught dancing class
- October 28, 1881--Republican caucus held to select delegates to the county convention
- November 19, 1885--Second of series of "select dancing parties" of the Seneca Falls Knights of Labor held
- September 14, 1886--Meeting held to settle the Porter Street sewer question. "The result of the whole business was the adoption of a resolution 'that the Porter street surface sewer commence on State street and go west on Porter street to and down Mynderse street.'"
- November 4, 1887--Prohibition meeting held under auspices of Seneca Falls Prohibition Club, Reverend J.H. Harter of Auburn gave address
- January 25, 1888--Young people of the Wesleyan Methodist Church host a concert by the Centennial Jubilee singers of Harper's Ferry
- April 29, 1890--Women of the Methodist Episcopal Church sponsor the "Carnival of Trades" to benefit the church's parsonage debt; young ladies and gentlemen represented the different businesses of the village, with literary exercises accompanying the carnival; ice cream, cake, sandwiches and coffee were served. Admission \$.10
- August 6, 1890--Republican caucus held to elect five delegates to the county convention, to be held August 23 at Romulus

Johnson Opera House

- November 1, 1890--Opening entertainment at the opera house; The Rochester Mandolin orchestra performed with Jessie Bonstelle, elocutionist
- November 3, 1890--Members of Iron Moulders' Union hold grand benefit ball
- November 11, 1890--Women of the Congregational church host "Aunt Dinah's Husking Bee"
- November 18, 1890--Women of the Trinity church host five day carnival
- December 31, 1890--"Old Grimes Cellar Door" performed
- January 3, 1891--New England comedy "Uncle Hiram" performed
- January 6, 1891--"The Runaway Wife," a romantic drama in five acts, performed; "The situations are startlingly strong, the climaxes and language good and the scenic effects particularly fine."
- January 15, 1891--"Mugg's Landing" performed; prices \$.20 and \$.30
- January 16, 1891--"Gip" performed; prices \$.20 and \$.30
- January 17, 1891--Bishop's Comedy company performed "Dot," prices \$.20 and \$.30
- January 20, 1891--Barlow Brothers, travelling minstrel company performed
- February 25, 1891--The famous Fisk Jubilee Singers performed under auspices of the Congregational church society
- July 14, 1891--The "celebrated" Sam Small gave performance
- October 6, 1891--Congressman Horr of Michigan spoke to "open the campaign in Seneca Falls"
- October 12, 1891--Republican electors met in county convention to nominate county officers to be supported in coming election
- April 27, 1892--Opera company entertainment
- May 5, 1892--The Rose Hill English Folly Company, a traveling burlesque and vaudeville group, performed
- May 31, 1892--Memorial Day services; Charles A. Hawley, esq. delivered lecture, Reverend G.A. Story and Reverend S.M. Newland, and a quartette of ladies and gentlemen assisted in the services, conducted by Henry H. Jones, commander of Cross Post

June 14, 1892--McGibeny Family gave concert; "popular prices" were \$.25, \$.35, \$.50

July 22, 1892--The Catholic club hosted the "popular emotional drama in five acts, 'Cast Upon the World'" for the benefit of the club, which advanced the social and educational interests of members, cost \$.25

October 24, 1892--Wade's Metropolitan Stars performed

June 20, 1893--"Temple of Fame" presented under auspices of the Woman's Relief Corps

September 7, 1893--John L. Sullivan, ex-champion pugilist, performed in "That Man From Boston"; "Of course, the most interest centered in the ex-champion who was seen at this best in the glove contest with Dan Dwyer in the fourth act."

April 23-24, 1894--The comedienne Annie Ward Tiffany performed two of her most brilliant successes on successive nights; "Lady Blarney" and "Peggy Logan"

September 4, 1895--Concert held for the benefit of the Seneca Falls Library

January 15, 1897--"The Legend of Don Munio" sung by the Choral Union of Seneca Falls

January 8, 1898--Mlle. Rhea performed as Josephine in new Napoleonic play "The Empress"

January 28, 1898--Select Masque Ball held under auspices of The Silsby Hose Co., No. 2

January 24, 1901--The musical farce company "Who is Who" appeared

January 7, 1906--"The Village Parson" presented

January 10-12, 1906--The Nellie Kennedy Stock Company entertained

January 12, 1906--Moving picture entertainment presented

February 5, 1906--John W. Vogel's fine minstrel troupe performed

February 22, 1906--Two games of basketball played; between the Geneva Midgets and the Father Matthew second team; and between the regular Father Matthew team and Engle Birds of Syracuse

April 30-May 1, 1906--Moving pictures presented for benefit of the Seneca Falls baseball club

May 3, 1906--"Esmeralda" presented for benefit of Seneca Falls baseball club

May 17, 1906--May party given under auspices of the rink orchestra

June 25, 1906--"The Rector of St. Mark's" presented under auspices of Hyperion lodge of Odd Fellows

September 24-25, 1906--Cook & Harris company present moving picture show

October 12, 1906--Republican meeting held, featuring the party's nominee for governor, Mr. Hughes

October 26, 1906--De Rue minstrels performed

November 2, 1906--The Hadley moving pictures exhibited under auspices of Philathea Society of the Baptist church

November 5, 1906--Annual dance of the Father Matthew society held

November 6-10, 1906--Addie La Porte and the Salisbury Murray Stock Company in "The Gambler's Wife"; "Skate Saturday Afternoon & Eve."

November 12-13, 1906--Clifton Mallory's production of "David Garrick" presented for benefit of Woman's Relief Corps

November 14-16, 1906--Skating

December 8-9, 1906--Roller skating

December 13, 1906--J.C. Rockwell's New Sunny South company performed, with "noon parade"

January 4-5, 1907--Roller skating

January 7, 1907--M.O.E. Wee presented the pastoral drama "The Village Parson"

January 10-12, 1907--The Nellie Kennedy Co., appeared in a repertoire of "strong Dramatic Successes"

February 8, 1907--Rowland and Clifford's dramatic production "Thorns and Orange Blossoms" presented

February 9-10, 1907--Roller skating

February 11, 1907--Frank Whittier's musical comedy "A Dutchman's Honeymoon" presented

February 13, 1907--A.L. Scammon's melodrama "Side Tracked" presented, "Direct from the big cities with special scenery and High Class People"

March 2, 1907--"A Texas Ranger" presented

March 6, 1907--"The Beauty Doctor" presented

March 15-17, 1907--The Nellie Kennedy Stock Co. performed "That Boy Buster," "The Indiscretions of Gertrude," and "Miss Sherlock Holmes"

March 18, 1907--Roller skating

March 19, 1907--Dario, The Prince of Magic, performed illusions and mystifying American, Spanish and Hindoo magical feats

April 3, 1907--Hi Henry minstrel group performed

April 11, 1907--Grace Coghlan appeared in the comedy "Are You a Mason!"

April 17, 1907--Concert given by Clara Clemens, contralto, Marie Nichols, violinist and Edmund Wark, pianist

April 20, 1907--L.E. Gideon presented the "Famous Colored Comedian" A.A. Copeland, in the farce comedy "The Hottest Coon in Dixie"

April 23, 1907--Miss Grace Hopkins in "A Wife's Secret" presented

April 29, 1907--"Coon Hollow" presented

May 11, 1907--Brownlee & Reed's "Uncle Tom's Cabin" company performed

September 5, 1907--The "World-Famed Farcical Ecstasy" "What Happened to Jones" presented

Week of September 20, 1907--"The Passion Play" by moving picture representation presented

September 26, 1907--Roller skating, music by the Seneca Falls band

September 28, 1907--Fred E. Wright's musical revelry, "The Beauty Doctor"; prices matinee \$.25 and \$.50, evening \$.25, \$.50, \$.75, \$1.00

October 1, 1907--Comedians Appleton and Perry appear, along with the merry musical mixup "My Wife's Family"

October 5, 1907--Daniel Sully appeared in "The Golden Rule"

October 10, 1907--"Leah Kleschna" presented

October 17, 1907--W.E. Wee presented the four act drama "The County Sheriff," written by Kathleen Fanoie Kennedy

October 21, 1907--Rowley-Gay Company, featuring Nine Gay opened for one week in repertoire of new plays, beginning with "The Little New York Waif" and five vaudeville acts; roller skating Friday and Saturday evenings

October 31, 1907--John W. Vogel's Minstrels performed; parade at noon

November 1, 1907--Marks Dramatic Company performed

November 2, 1907--Musical comedy surprise "Brown From Missouri" presented with Hal Brown and Frances Brooke

November 4, 1907--Edwin J. Hadley, king of picture shows, presented

November 11, 1907--Old Fellows' Fair opened for two weeks

November 26, 1907--Wrestling matches between Charles Kaiser and H. Miller; and "Tax" Delave and Edward Gardner

December 9, 1907--Nellie Kennedy and company, 20 people, seven vaudeville acts, opened for one week

December 16, 1907--Big vaudeville show, pictures and songs, opened for the week, every night except Wednesday

December 23, 1907--"Lion and the Mouse" presented

December 24, 1907--Stetson's "Uncle Tom's Cabin" presented

December 25, 1907--"Biggest Picture Show ever in Seneca Falls" presented

January 1, 1908--"Hooligan in New York" presented

January 3-4, 1908--Skating, with band

January 6, 1908--Lulu Mae Vroman appeared in "For Her Father's Sake"

January 11, 1908--"The Poor Mr. Rich" presented, with 10 musical hits and "Clever Comedians"

January 13, 1908--French hypnotist Pauline performed

January 20-22, 1908--Advanced vaudeville with 10 acts presented

January 25, 1908--"The Toy Maker" presented with 25 original music numbers

January 30, 1908--"Uncle Josh Perkins" presented, "See Uncle Josh at the County Fair, Watch for the Big Parade of the Hayseed Band"

February 1, 1908--"Simple Simon" presented

February 3, 1908--Wrestling match between Chas. Kaiser vs. Joe Urlacher

February 11, 1908--The Castellano Operatic Concert company with Signor Eduardo Castellano, tenor, performed

February 24, 1908--Great rural comedy drama "The Choir Singer" presented

February 25-26, 1908--"Garden Party" given by Trinity Church Guild

February 29, 1908--"Jerry from Kerry" band and orchestra performed

March 2, 1908--George F. Hall in "A Gay Old Sport" presented

March 3, 1908--"The Man of the Hour" presented

March 7, 1908--"As Told in the Hills" presented

March 9, 1908--"The Arrival of Kitty" presented

April 27-28, 1908--Local lodge of Elks gave two minstrel exhibitions with home talent from Seneca Falls and Waterloo

Week of May 8, 1908--Dr. B.F. Beardsley of Hartford, Connecticut, delivered a course of lectures on health

May 11, 1908--De Rue Brothers' minstrels presented entertainment

May 14, 1908--Public meeting held under auspices of Citizens' club to discuss municipal water works question pro and con

May 27, 1908--Observance of 60th anniversary of the 1848 Women's Rights Convention in the Wesleyan Chapel

September 11, 1908--Musical comedy "Panhandle Pete" presented, with cast of 15 and chorus of 20 male and female voices

September 28-29, 1908--"Cameraphone" with its mechanical talking pictures exhibited

October 3, 1908--"Out in Idaho," cowboy play, presented

October 9, 1908--"Celebrated pictures" of the recent Gans-Nelson prize fight presented

October 22, 1908--Governor Hughes gave brief speech while on campaign tour

October 22, 1908--Joshua King's company presented "East Lynne"

December 11, 1908--"The Arrival of Kitty" presented

December 15, 1908--"The Follies of New York" presented

February 23, 1912--Joseph Conyer's production of "Our New Minister"
presented

November 1915--Elizabeth Cady Stanton's 100th birthday celebration

PERSONS CONSULTED DURING RESEARCH

Betty Auten, Seneca County historian, Waterloo, New York

Wallace Beardsley Jr., Auburn, New York

David Broadherson, Ithaca, New York

Elaine Brown, Geneva, New York

Amy Dougherty, university archivist, Syracuse University, Syracuse,
New York

Dr. Corinne Guntzel, professor, Department of Economics, Wells College,
Aurora, New York

Gerilyn Heisser, ex-executive director, Seneca Falls Historical Society,
Seneca Falls, New York

Opal Ottemiller, ex-president, Seneca Falls Historical Society, Seneca
Falls, New York

Barbara E. Pearson, architectural conservator, National Park Service,
Boston, Massachusetts

Scott Smith, clerk/treasurer, Village of Seneca Falls, New York

William W. Turverey, pastor, Brockville Wesleyan Church, Brockville,
Ontario

Fred Van Nostrand, county clerk, Seneca County, Waterloo, New York

Janet Riggs Waterman, Ithaca, New York

Dr. Judith Wellman, professor, Department of History, State University of
New York, Oswego, New York

Diana Wildeman, interim director, Seneca Falls Historical Society, Seneca
Falls, New York

REPOSITORIES VISITED DURING RESEARCH

LAKESWOOD, COLORADO

Rocky Mountain Region Office Library

WASHINGTON, DISTRICT OF COLUMBIA

Library of Congress

Newspaper and Current Periodical Room

Prints and Photographs Division

ITHACA, NEW YORK

Cornell University

Fine Arts Library

Mann Library and Annex

Olin Library

Department of Manuscripts and University Archives

SENECA FALLS, NEW YORK

Seneca Falls Historical Society

Village of Seneca Falls Archives

Women's Rights National Historical Park

WATERLOO, NEW YORK

Seneca County Archives

Seneca County Courthouse

County Clerk Office

REPOSITORIES CONSULTED DURING RESEARCH

WASHINGTON, DISTRICT OF COLUMBIA

Library of Congress
Prints and Photographs Division
Architecture, Design, and Engineering Collections
Wesley Theological Seminary
Library

MARION, INDIANA

The Wesleyan Church
Archives and Historical Library

WINONA LAKE, INDIANA

Free Methodist Church Headquarters
Marston Memorial Historical Center

CAMBRIDGE, MASSACHUSETTS

The Arthur and Elizabeth Schlesinger Library on the History of Women
in America

ADRIAN, MICHIGAN

The United Methodist Church
Detroit Annual Conference
The Commission on Archives and History
Archives, Adrian College Library

MADISON, NEW JERSEY

The United Methodist Church
General Commission on Archives and History

NEW BRUNSWICK, NEW JERSEY

Rutgers The State University of New Jersey
Douglass and Cook Colleges
Mabel Smith Douglass Library

ALBANY, NEW YORK

The New York State Library
Cultural Education Center

BIG FLATS, NEW YORK

The Wesleyan Church
Central New York District

COOPERSTOWN, NEW YORK
New York State Historical Association

NEW YORK, NEW YORK
Columbia University
 Avery Architectural and Fine Arts Library
The Granger Collection
G.D. Hackett, Photography
The New York Historical Society
The New York Public Library
 Rare Books & Manuscripts Division

POUGHKEEPSIE, NEW YORK
Vassar College
 The Library

ROCHESTER, NEW YORK
International Museum of Photography at George Eastman House
The Landmark Society of Western New York
Rochester Public Library
 Local History Division

REPOSITORIES VISITED OR CONSULTED BY ELAINE BROWN

AUBURN, NEW YORK
Seymour Library

GENEVA, NEW YORK
Geneva Free Library
Geneva Historical Society
Hobart & Wm Smith Colleges
Warren Hunting Smith Library

HOUGHTON, NEW YORK
Houghton College
Library

LYONS, NEW YORK
Wayne County Historical Society

PALMYRA, NEW YORK
Kings Daughters Free Library

ROCHESTER, NEW YORK
Colgate Divinity School
Library
University of Rochester
Rundel Library

WATERLOO, NEW YORK
Waterloo Library and Historical Society

ILLUSTRATIONS

Illustration 1. 1836 Seneca Falls Map.

SCALE

165 Feet or 18 Rods to an Inch

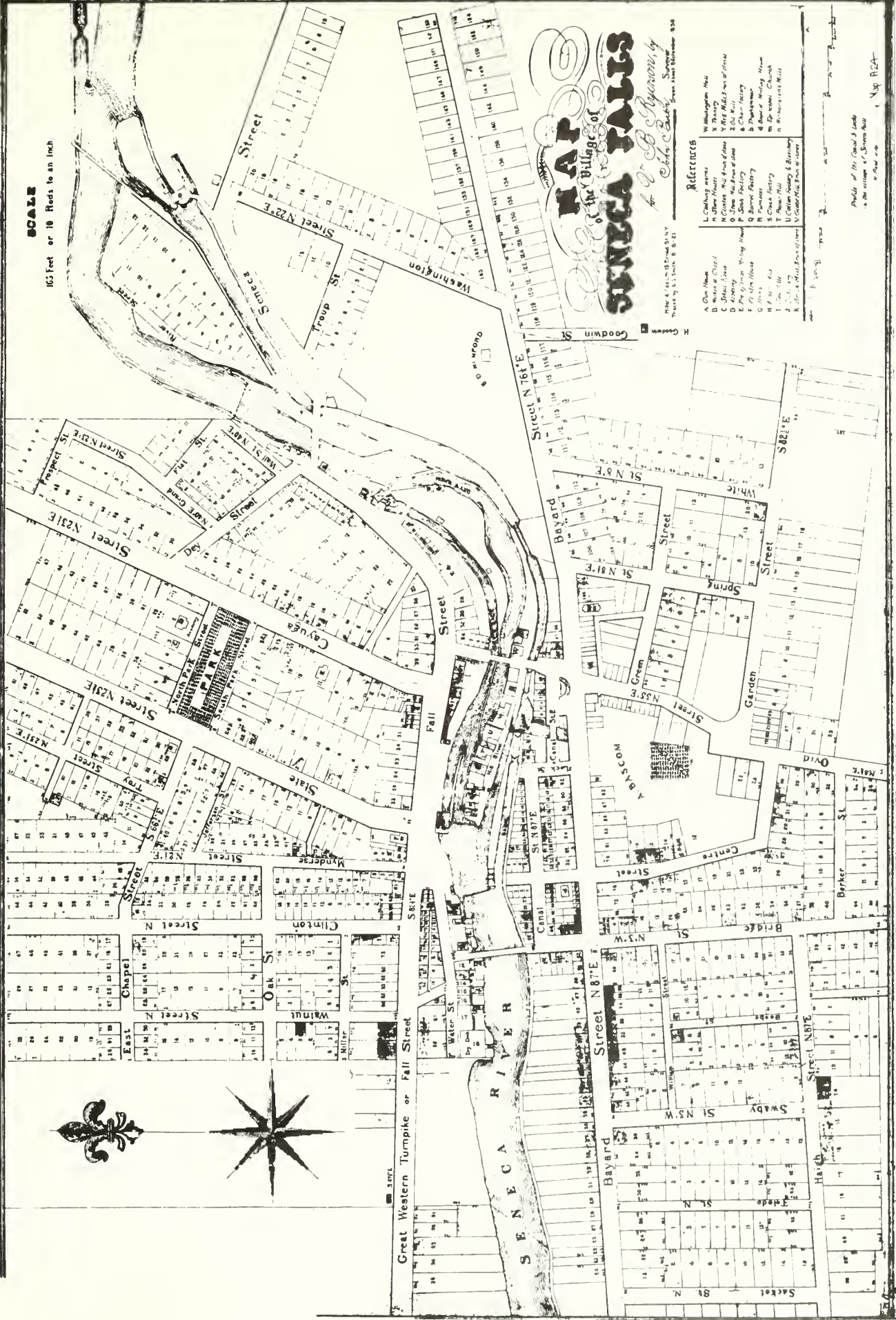

WATER

of the Village of

SENECA FALLS

for John B. Reynolds, Jr.

Surveyed by J. B. Reynolds, Jr. from 1825 to 1830

- References**
- A. Gun House
 - B. Water & Chapel
 - C. John's Store
 - D. Academy
 - E. Church
 - F. Church
 - G. Church
 - H. F. B. A. S.
 - I. F. B. A. S.
 - J. F. B. A. S.
 - K. F. B. A. S.
 - L. F. B. A. S.
 - M. F. B. A. S.
 - N. F. B. A. S.
 - O. F. B. A. S.
 - P. F. B. A. S.
 - Q. F. B. A. S.
 - R. F. B. A. S.
 - S. F. B. A. S.
 - T. F. B. A. S.
 - U. F. B. A. S.
 - V. F. B. A. S.
 - W. F. B. A. S.
 - X. F. B. A. S.
 - Y. F. B. A. S.
 - Z. F. B. A. S.

Printed at the Seneca Falls
by J. B. Reynolds, Jr.

Map 1825

Illustration 2. 1836 Seneca Falls Map, Detail.

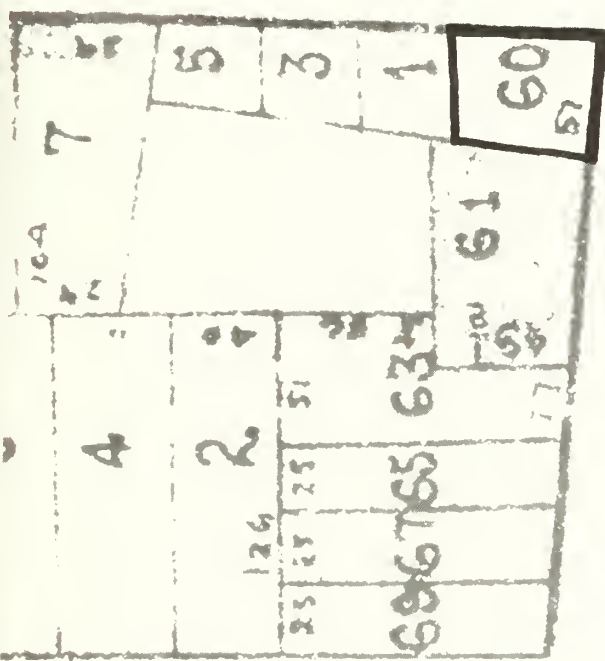
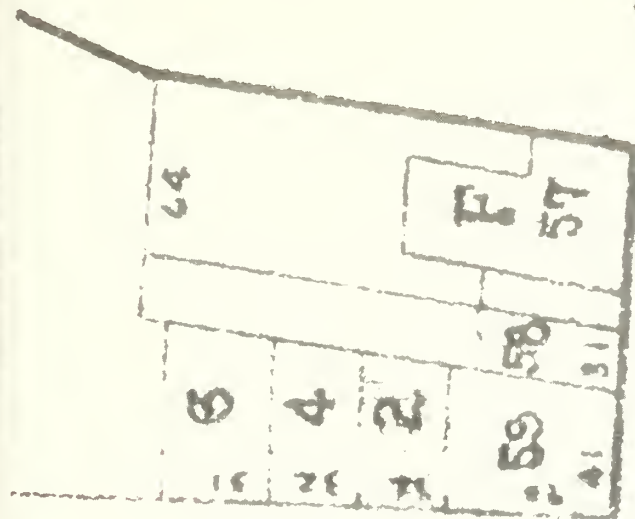

S. 82 1/2° E

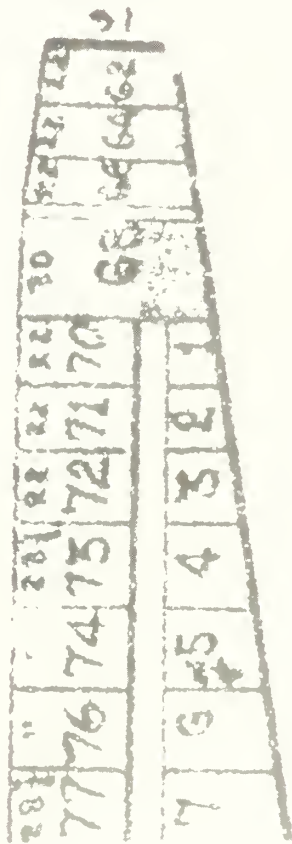

Illustration 3. Luther Lee. From McLeister, History of the Wesleyan Methodist Church of America.

Illustration 4. Samuel Salisbury. From Welch, "Grip's" Historical Souvenir of Seneca Falls.



*Yours for the whole truth
Luther Lee.*



REV. SAMUEL SALISBURY

Illustration 5. William W. Lyle. SFHS #2488.



Illustration 6. View of probable Wesleyan Chapel behind the Arnett Mill. From 1856 Cadastral Map.



Illustration 7. Interior of Old Wesleyan Church with Pastor, Superintendent & Teachers of Sabbath School, ca. 1858. SFHS #127.

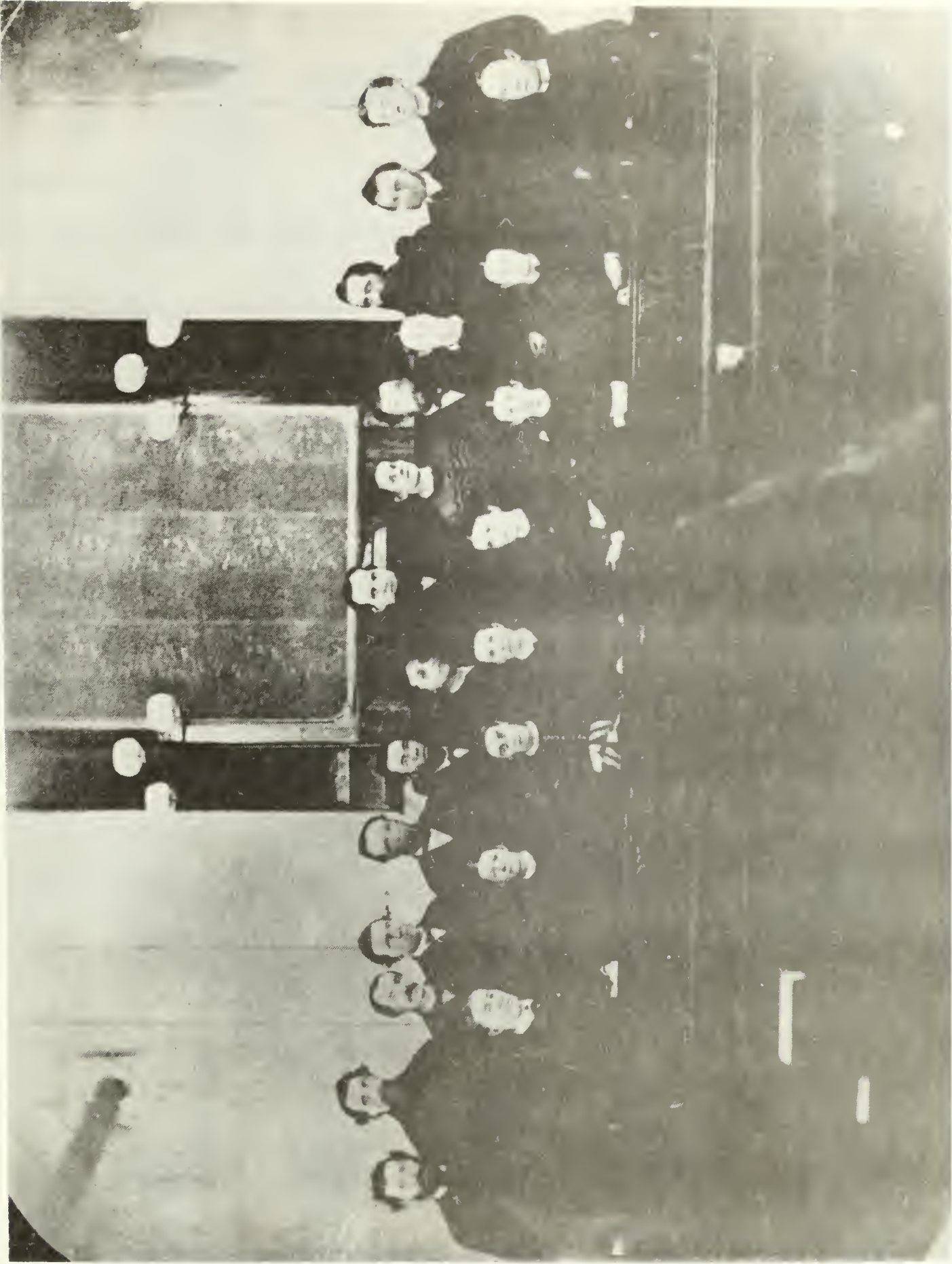

Illustration 8. 1856 Seneca Falls Map.

J. H. FRENCH
PHILADELPHIA
1850



Residence of J. C. Lundy



Residence of J. C. Lundy



Residence of J. C. Lundy



Residence of J. C. Lundy



Residence of J. C. Lundy



Residence of J. C. Lundy



Residence of J. C. Lundy



Residence of J. C. Lundy



Residence of J. C. Lundy

Illustration 9. 1856 Seneca Falls Map, Detail.

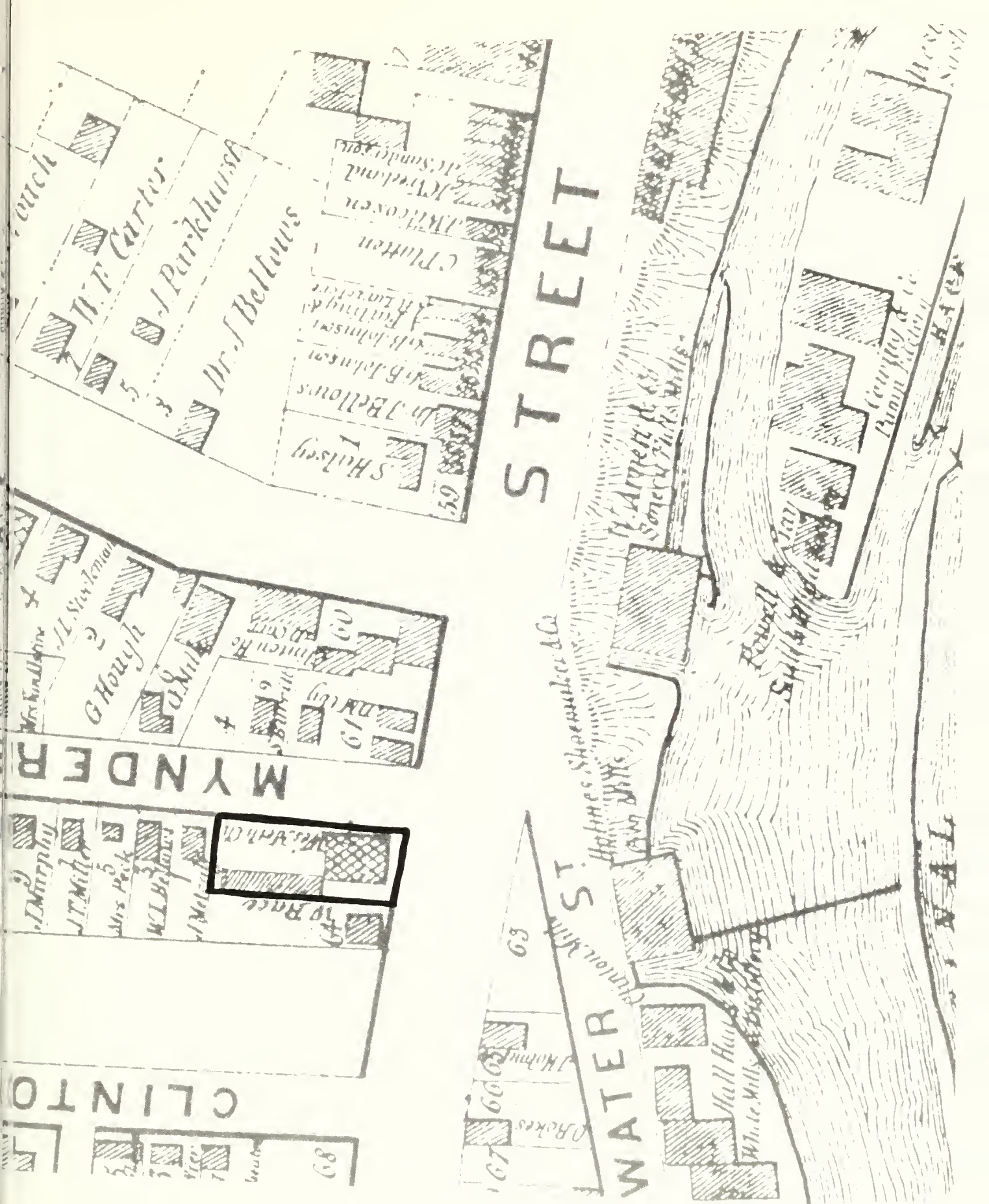

CLINTON

MYNDER

STREET

WATER

W. F. Carter

Dr. J. Bellows

J. Parkhurst

S. Shilsey

W. F. Carter

J. Parkhurst

S. Shilsey

Illustration 10. 1871 Seneca Falls Map.

MAP OF
THE VILLAGE OF
SENECA FALLS
SENECA CO.
NEW YORK.

PUBLISHED BY
W. W. RICHIE
ASSISTED BY T. A. CUNNINGHAM & C.
279 Chestnut St.
PHILADELPHIA.

1871
Scale 400 Feet per Inch
Copyright 1870



**SENECA FALLS
BUSINESS DIRECTORY.**

Business Name	Address
Adams Express Co.	100 Seneca St.
Amesbury & Co.	100 Seneca St.
Anderson & Co.	100 Seneca St.
...	...
W. W. Richie	279 Chestnut St. Phila.

Illustration 11. 1871 Seneca Falls Map, Detail.

Williams
F

Williams
Collings

Failing

Guinn	W	Quincy	J
Williams	W	Murphy	J A
Williams	W	Curtiss	
Williams	W		
	P	W L	Bellows
Troutman		E	Desky
		W Race	
	Seekell		CH.

MYNDE

W
Houseman
Res of
Dr R C Dunham
Office
G
Milke
Palmer
Hoag
Hotel
M Hoag

BSS
Geo
McQuillan
Wag St
Eng

Daniels
H Cadwell
L B Howell
ST

Mills
Phoenix Property
National Exchange
Bank Property

Illustration 12. The five women who organized the 1848 Women's Rights Convention. From Becker, History of Waterloo New York and Thesaurus of Related Facts.

Mary Ann McClintock

Martha Wright

Elizabeth Cady Stanton

Lucretia Mott

Jane Hunt

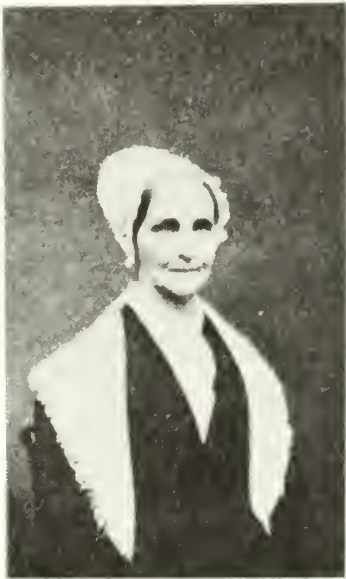
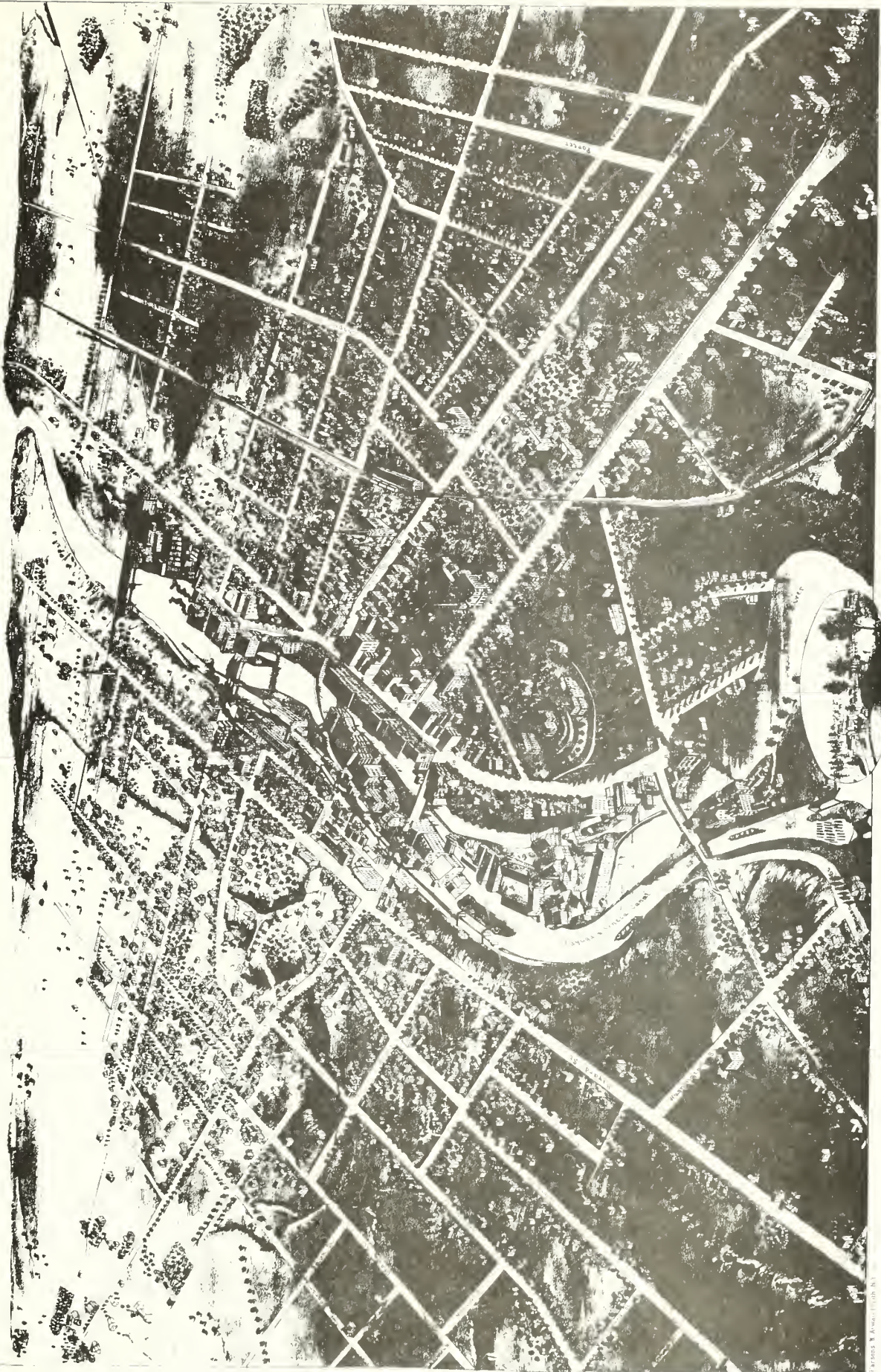

Illustration 13. 1873 Seneca Falls Map.



BIRD'S EYE VIEW OF SENECA FALLS, N. Y. 1878.

- MANUFACTURING REFERENCES:**
1. The Seneca Falls Manufacturing Co.
 2. The Seneca Falls Manufacturing Co.
 3. The Seneca Falls Manufacturing Co.
 4. The Seneca Falls Manufacturing Co.
 5. The Seneca Falls Manufacturing Co.
 6. The Seneca Falls Manufacturing Co.
 7. The Seneca Falls Manufacturing Co.
 8. The Seneca Falls Manufacturing Co.
 9. The Seneca Falls Manufacturing Co.
 10. The Seneca Falls Manufacturing Co.

- REFERENCES:**
1. The Seneca Falls Manufacturing Co.
 2. The Seneca Falls Manufacturing Co.
 3. The Seneca Falls Manufacturing Co.
 4. The Seneca Falls Manufacturing Co.
 5. The Seneca Falls Manufacturing Co.
 6. The Seneca Falls Manufacturing Co.
 7. The Seneca Falls Manufacturing Co.
 8. The Seneca Falls Manufacturing Co.
 9. The Seneca Falls Manufacturing Co.
 10. The Seneca Falls Manufacturing Co.

BIRD'S EYE VIEW OF SENECA FALLS, N. Y. 1878.

- REFERENCES:**
1. The Seneca Falls Manufacturing Co.
 2. The Seneca Falls Manufacturing Co.
 3. The Seneca Falls Manufacturing Co.
 4. The Seneca Falls Manufacturing Co.
 5. The Seneca Falls Manufacturing Co.
 6. The Seneca Falls Manufacturing Co.
 7. The Seneca Falls Manufacturing Co.
 8. The Seneca Falls Manufacturing Co.
 9. The Seneca Falls Manufacturing Co.
 10. The Seneca Falls Manufacturing Co.

- REFERENCES:**
1. The Seneca Falls Manufacturing Co.
 2. The Seneca Falls Manufacturing Co.
 3. The Seneca Falls Manufacturing Co.
 4. The Seneca Falls Manufacturing Co.
 5. The Seneca Falls Manufacturing Co.
 6. The Seneca Falls Manufacturing Co.
 7. The Seneca Falls Manufacturing Co.
 8. The Seneca Falls Manufacturing Co.
 9. The Seneca Falls Manufacturing Co.
 10. The Seneca Falls Manufacturing Co.

Illustration 14. 1873 Seneca Falls Map, Detail.

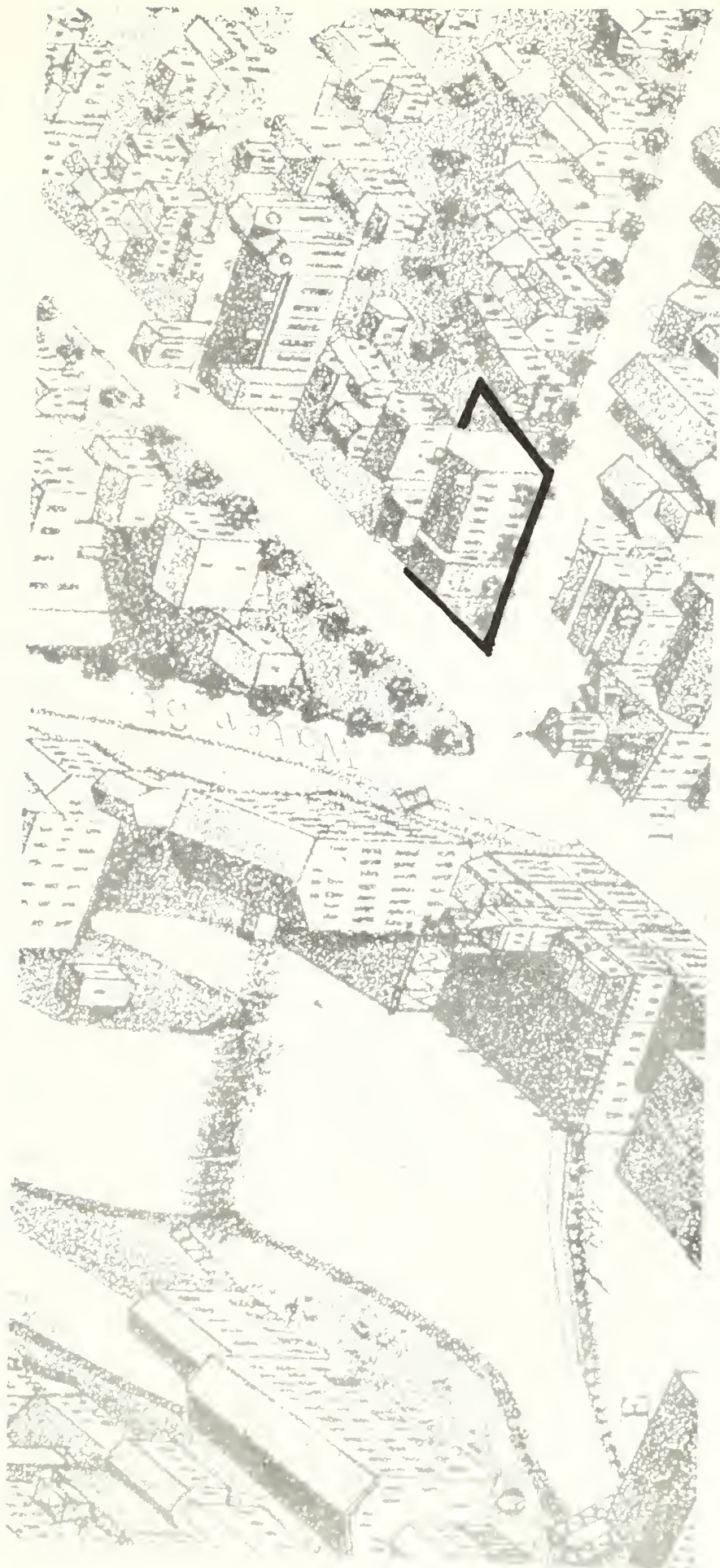
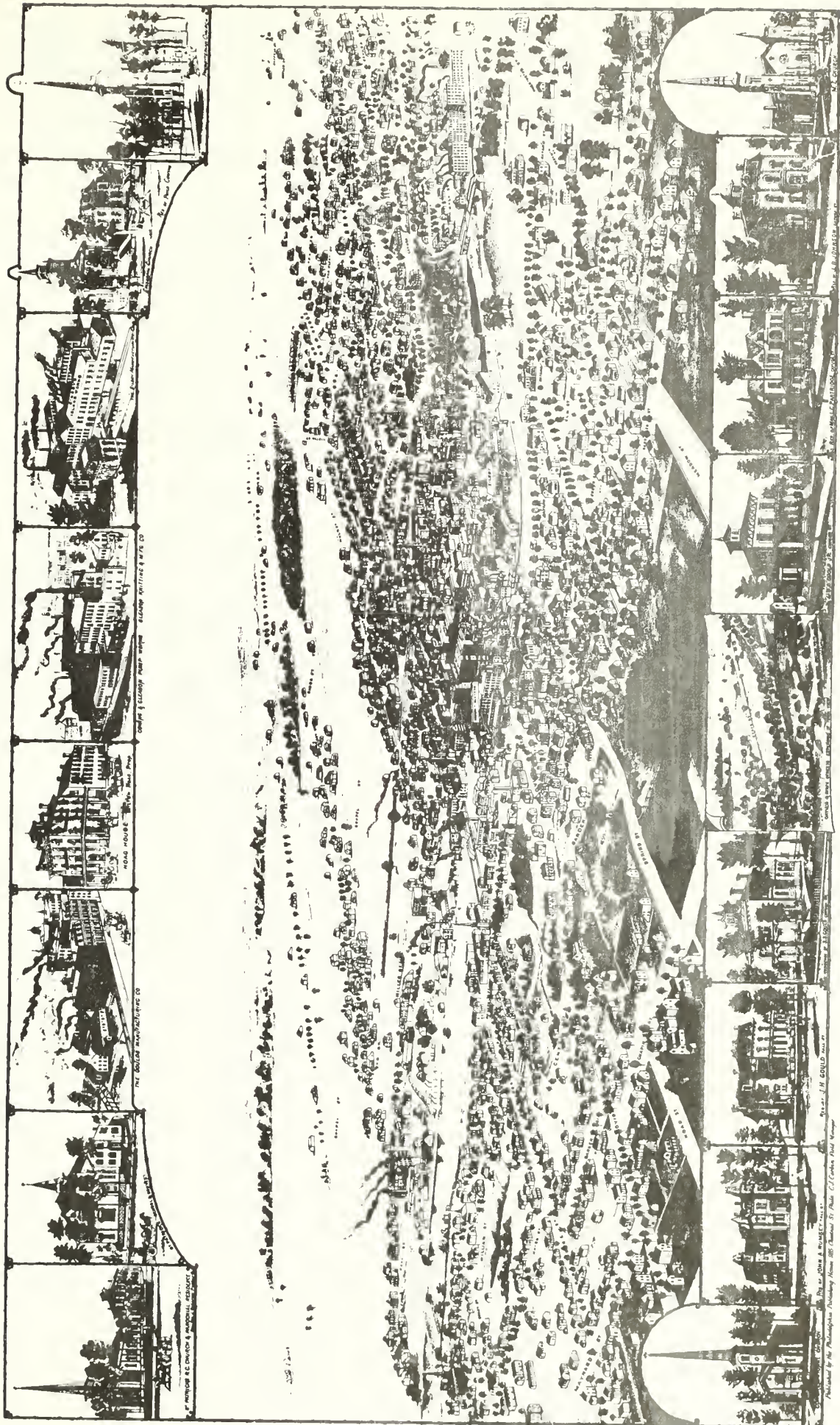

Illustration 15. 1882 Seneca Falls Map.



SENECA FALLS, NEW YORK, 1882.
 LOOKING NORTH-WEST.

Illustration 16. 1882 Seneca Falls Map, Detail.

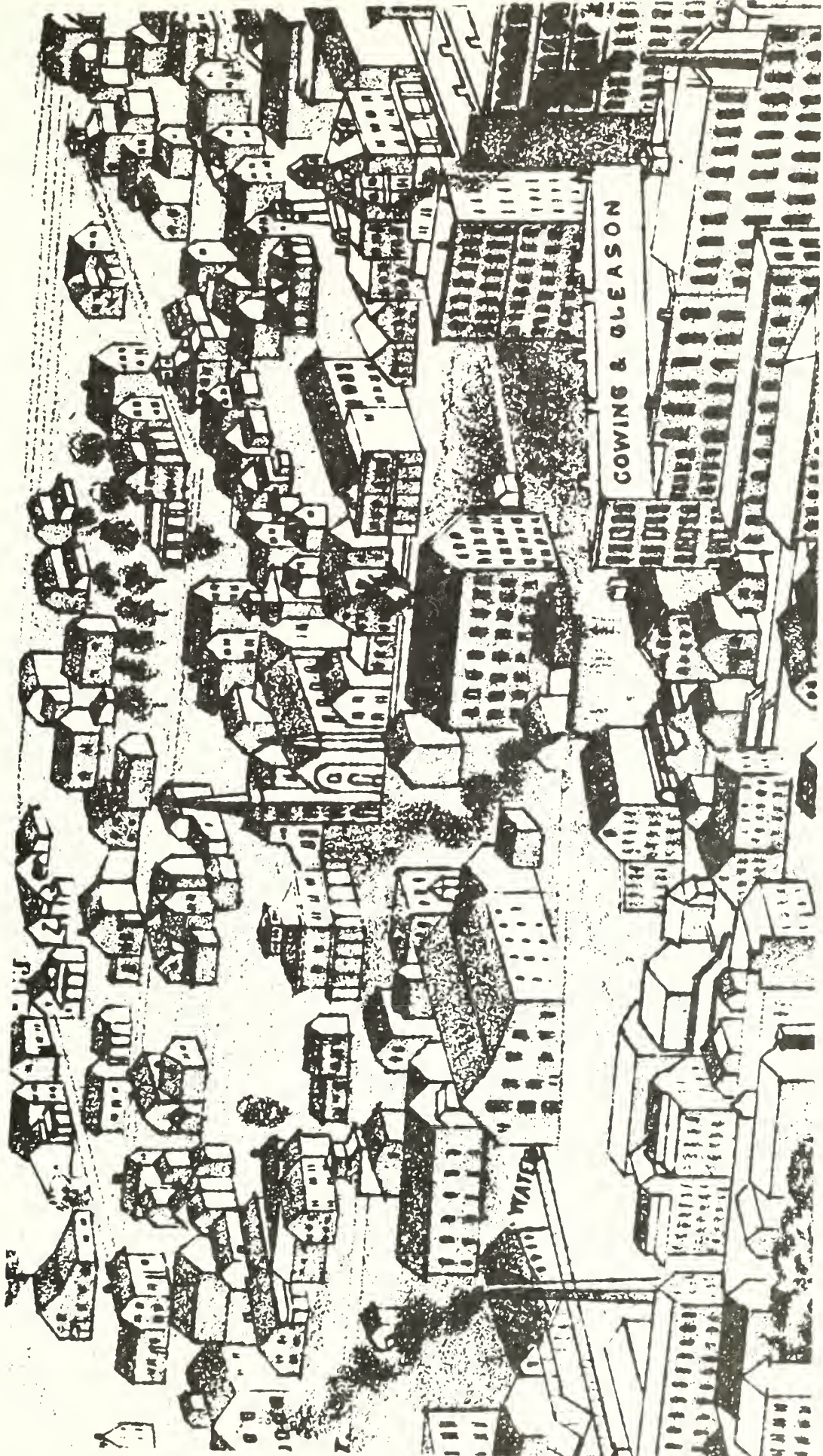

Illustration 17. William Johnson. SFHS #880.

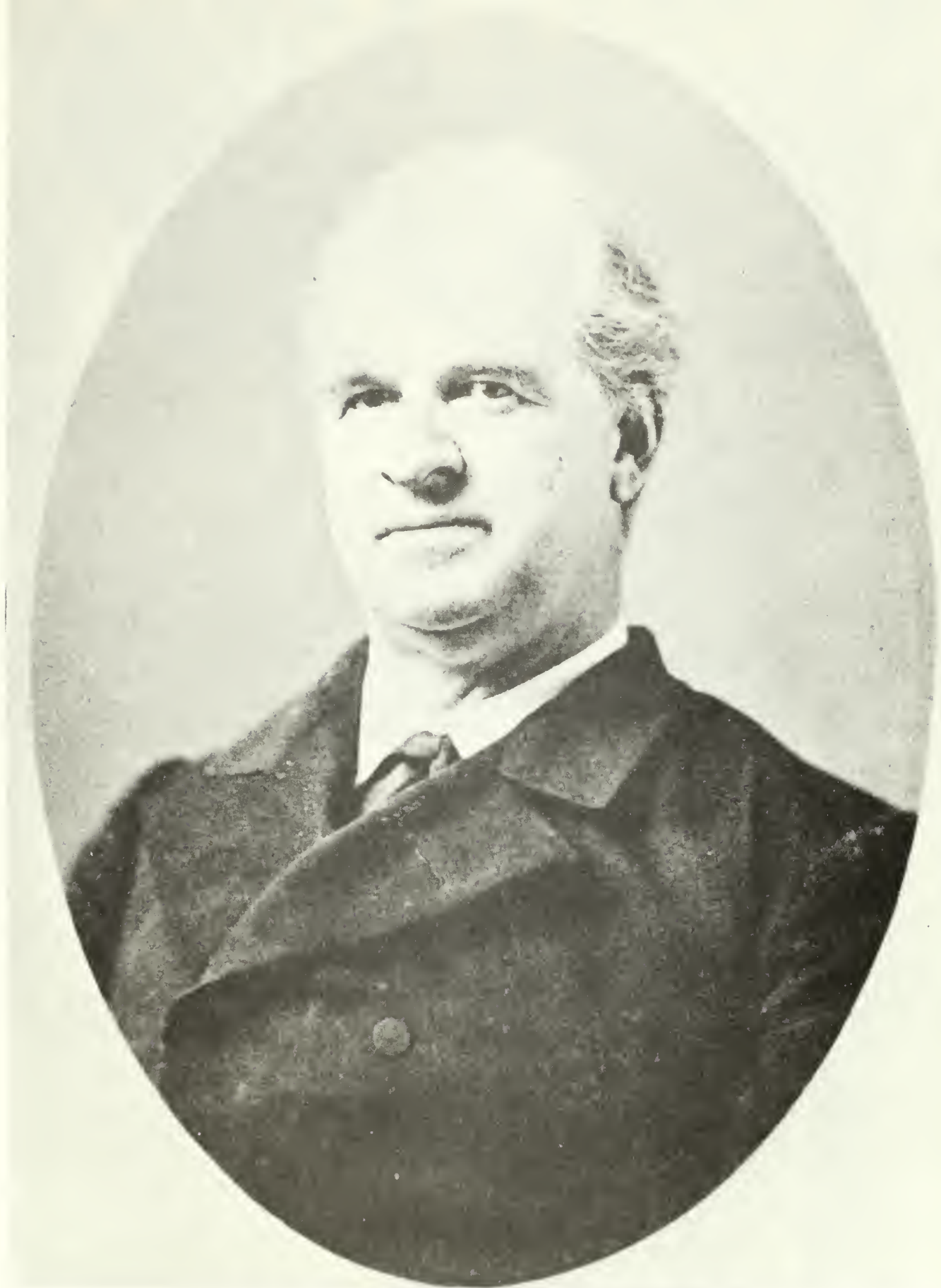

Illustration 18. Residence of Senator William Johnson. From History of Seneca Co.

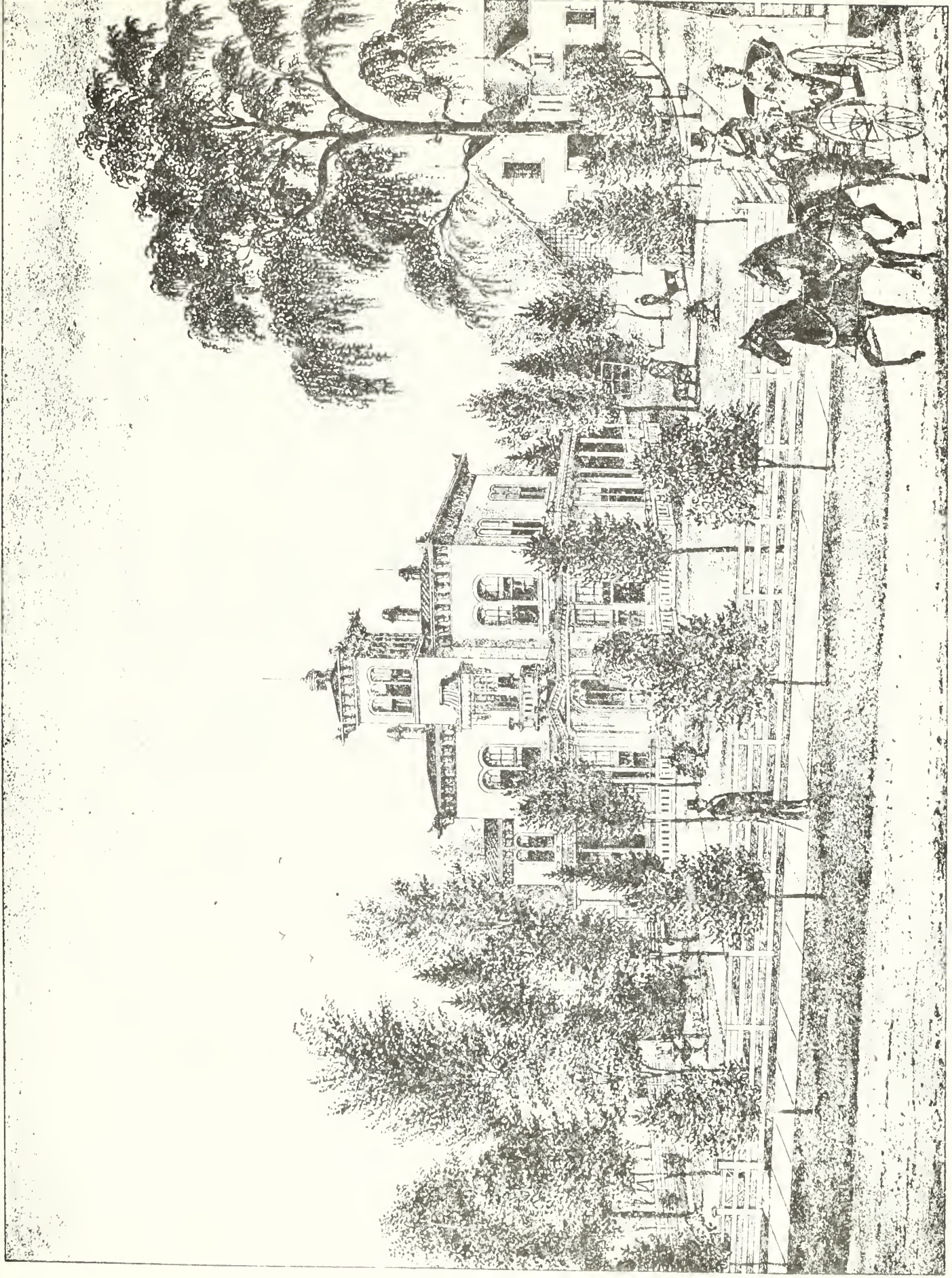

Illustration 19. "Grand Rally at Johnson Hall, To-Night" Handbill.
Archives Collection 32 Recreational and Performing Arts Collection, Box 1,
Folder 3, SFHS.

PRINCIPLES NOT MEN!

GRAND RALLY

At Johnson Hall,

TO-NIGHT.

Hon Jas. G. Maguire

WILL SPEAK TO NIGHT FOR

HENRY GEORGE

AND THE UNITED LABOR PARTY.

LET EVERYBODY COME AND HEAR THIS ELOQUENT JUDGE
OF THE SUPERIOR COURT OF CALIFORNIA.

SPECIAL INVITATION TO LADIES

JOURNAL PRINT

Illustration 20. "Pepita! The Gipsy Girl of Andalusia!" Handbill.
Archives Collection 32 Recreational and Performing Arts Collection, Box 1,
Folder #, SFHS.

PEPITA!

— o T H E o —

Gipsy Girl of Andalusia!

FRIDAY EVE., DEC. 26, 1873.

A TRAGIC BURLESQUE OPERA! IN FIVE ACTS.

Overture by Full Orchestra!

DRAMATIS PERSONÆ.

Don Carlos, a Spanish Count.....	E. M. Failing
Donna Inez, his wife.....	Sarah Leach
Pepita, their child.....	Margiea Rumsey
Dolores, Pepita's nurse.....	Paul Palmer
Margueritta, Dolores' daughter.....	Lillie Schermerhorn
Don Enrique, nephew of Don Carlos.....	E. D. Henion
Beverly Howard, Lieut. Commander U. S. N.....	J. M. Latham
Maynard Moore, } Lieutenants, {	J. Cowing
Paul Dayton, }	M. Dye
Clarence Bruce, }	L. Compson
Ben Bolt, }	J. Carr
Jose, Chief of the Gipsies.....	L. J. Rumsey
Lola, Queen of the Gipsies.....	Georgie Kline
Joanna.....	Nannie Guild
Zerolina.....	Fanny Lang
Elvira.....	Lillie Lewis
Amma.....	Carrie Twining
Meg.....	Addie Jewett
Mecansa.....	Debbie Hoster
Lurline.....	Jessie Coleman
Didama.....	Maud Murray
Christina.....	Lizzie Rumsey
Magdalena.....	Maud Stowell
Diana.....	Flora Williams
Isabella.....	Mary Day

ACT I.

SCENE I. Enrique's daring plot; Dolores becomes an accomplice; "Tis Done."

SCENE II. Love duty by Jose; planted meeting; Margueritta unfolds the plan; "I swear;" Child stolen.

ACT II.

SCENE I. Mourning of servants for the lost Pepita; Assumed grief of Dolores; Grand Famine Tribunal; Enrique smites vainly.

SCENE II. Touching appeal by Enrique; is urged to stay; "Uncle, dear Uncle, I will."

SCENE III. Midnight; Jose under Dolores' window; her fright; "Hand me over the money;" Mourning solo by Jose.

(Fifteen years supposed to have elapsed.)

ACT III.

SCENE I. United States naval officers rowing towards shore; Gipsies heard in the distance; "Listen boys, just hear that singing; say, what is it Ben?"

SCENE II. Gipsy camp; fortune telling the chief attraction; hearts lost; fortunes made; meetings planned.

SCENE III. By far the most touching scene; Beverly proposes to Pepita; is accepted; Enrique discovers that Pepita still lives; Ben Bolt appears at the wrong time as usual.

SCENE IV. "Oh we're a jolly crew;" "What, ho! what have we here?" A bloody combat; Enrique mortally wounded; Beverly stabbed and faints to slow music.

ACT IV.

SCENE I. Gipsy camp; enter sailors; anguish of Pepita; "Beverly, my darling."

SCENE II. Sad news reaches Don Carlos; Lady Inez, still speechless; "more sorrow in store."

SCENE III. (Handkerchiefs will not be amiss.) Enrique's death-bed; he confesses his crime; "Pepita still lives;" he does not receive forgiveness.

ACT V.

SCENE I. "What would you do love?" Pepita's answer; grand rejoicings; "can you my mother be;" A warning to all gay deceivers; lively suicide, "my knife is sharp"; finale; perfectly elegant.

Doors open at 7 o'clock. Performances to commence at 7.45

Revelite Printing House, Seneca Falls, N. Y.

Illustration 21. "Grand Concert" Handbill. Archives Collection 32
Recreational and Performing Arts Collection, Box 1, Folder 3, SFHS.

GRAND CONCERT,

BY THE ST. PETER'S CHURCH CHOIR,

AT JOHNSON HALL,

Seneca Falls, N. Y., Monday Evening, November 5th, 1877.

Programme.

PART I.

1. TE DEUM LAUDAMUS, *Lloyd.*
ST. PETER'S CHURCH CHOIR.
2. PIANO SOLO—Polonaise in A, *Chopin.*
MR. CHAS. E. VANLAER.
3. KING FUN, *Millard.*
MR. FEDOR WILLIMEK.
4. DUETT—Fly Away, Birdling, *Abt.*
MISS JENNIE BROWNE AND MRS. ARNETT.
5. ZITHER SOLO—Waltz, *Buchegger.*
MR. FEDOR WILLIMEK.
6. ECCO QUEL FIERO ISTANTE,
ST. PETER'S CHURCH CHOIR.

PART II.

1. PIANO SOLO, *Selections.*
MR. CHAS. E. VANLAER.
2. SLEEP WELL, SWEET ANGEL, *Abt.*
MR. GEORGE S. GREEN.
3. MURMURING VOICE OF THE DEEP,
MRS. ARNETT.
4. THE MESSAGE, *Blumenthal.*
MISS BROWN.
5. ZITHER SOLO, *a. Fantasia,* *Oesten.*
b. Slumber Song, *Kucken.*
MR. FEDOR WILLIMEK.
6. DUETT—Cheerfulness. *Gumbert.*
MISS BROWNE AND MR. GREEN.
7. JESUS LOVER OF MY SOUL, *Williams.*
ST. PETER'S CHURCH CHOIR.

Knapp & Peck, Pres., Auburn.

Illustration 22. "Prohibition Meeting" Handbill. Archive Collection 28 Seneca Falls History Collection (General) Box 1, Folder 7, SFHS.

PROHIBITION MEETING.

AT
JOHNSON'S HALL,
FRIDAY EVENING NOV. 4 1887,

UNDER THE AUSPICES OF

THE SENEGA FALLS PROHIBITION CLUB!

The Rev. J. H. HARTER of Auburn Will Address the Meeting

Good Singing by the Club Choir Will Enliven the Occasion.

LET EVERY BODY COME AND BRING HIS WIFE, FRIENDS AND NEIGHBOR.

Illustration 23. 1881 Sanborn Map, Detail.

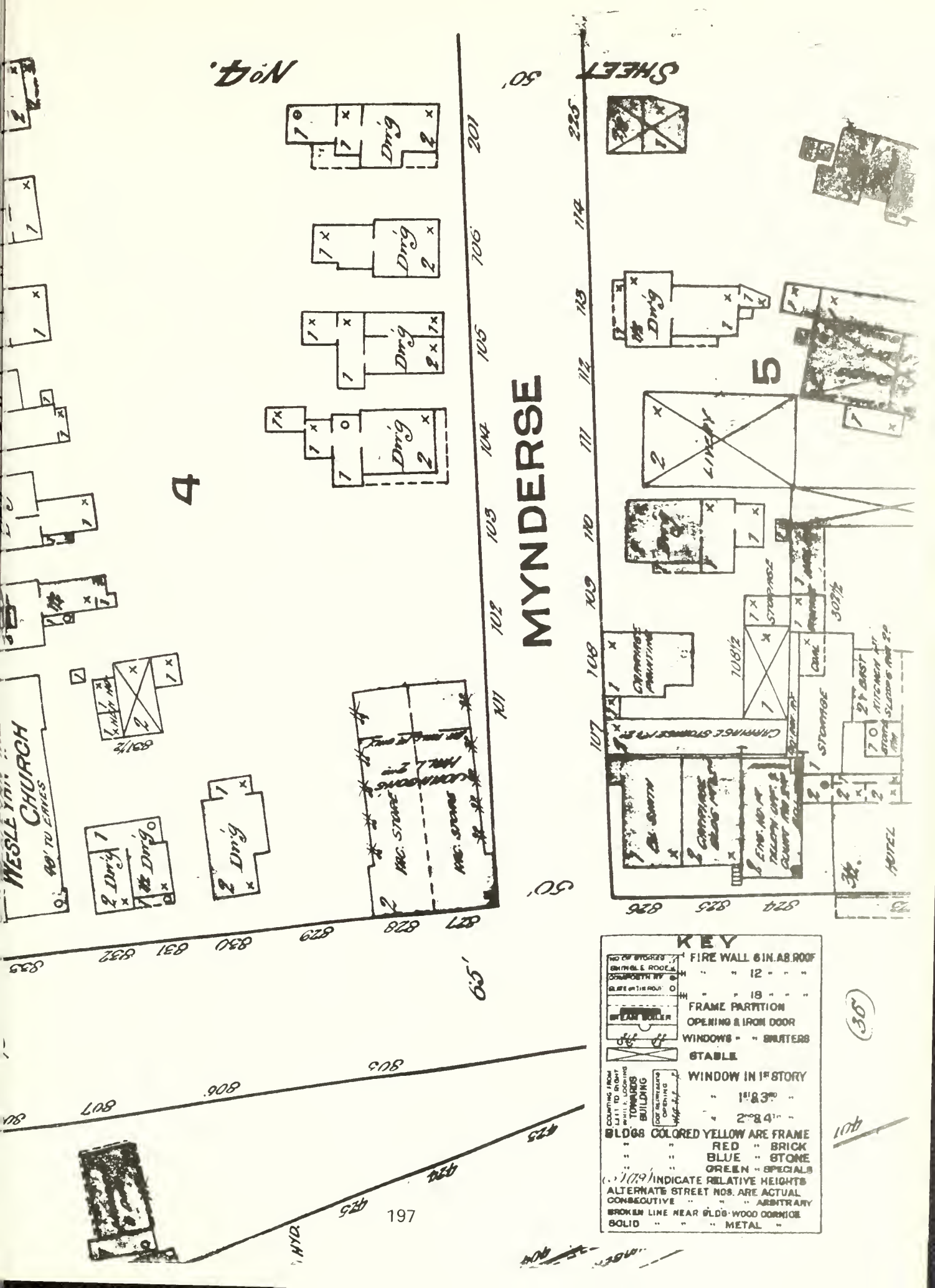

No. 4

4

MYNDRSE

SHEET

50

201

106

106

104

105

102

101

107

108

109

110

111

112

113

114

225

WESLEYAN CHURCH

90' TO ERIES

839

837

835

833

831

829

827

825

823

821

819

817

815

813

811

809

807

805

803

801

799

797

795

793

791

789

787

785

783

781

779

777

775

773

771

769

767

765

763

761

759

757

755

753

751

749

747

745

743

741

739

737

735

733

731

729

727

725

723

721

719

717

715

713

711

709

707

705

703

701

699

697

695

693

691

689

687

685

683

681

679

677

675

673

671

669

667

665

663

661

659

657

655

653

651

649

647

645

643

641

639

637

635

633

631

629

627

625

623

621

619

617

615

613

611

609

607

605

603

601

599

597

595

593

591

589

587

585

583

581

579

577

KEY

NO OF BYGERS	FIRE WALL 6 IN. AS ROOF
SHINGLE ROOF	" " 12 " "
COMBUSTIBLE	" " 18 " "
GLASS ON THE ROOF	FRAME PARTITION
OPENING	OPENING & IRON DOOR
WINDERS	WINDOWS " SHUTTERS
STABLE	WINDOW IN 1 ST STORY
" " " "	" " 1'8 3/4" "
" " " "	" " 2'8 3/4" "
LOGS	COLORS INDICATE RELATIVE HEIGHTS
" " " "	ALTERNATE STREET NOS. ARE ACTUAL
" " " "	CONSECUTIVE " " ARBITRARY
" " " "	BROKEN LINE NEAR BLDG. WOOD CORNICE
" " " "	SOLID " " METAL

30

40

Illustration 24. 1886 Sanborn Map, Detail.

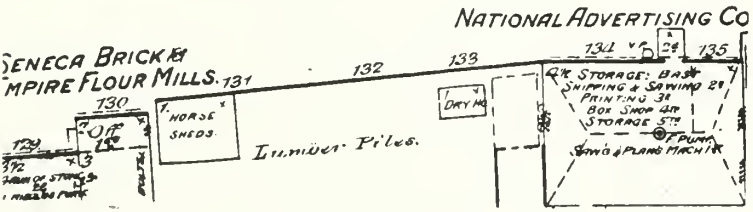
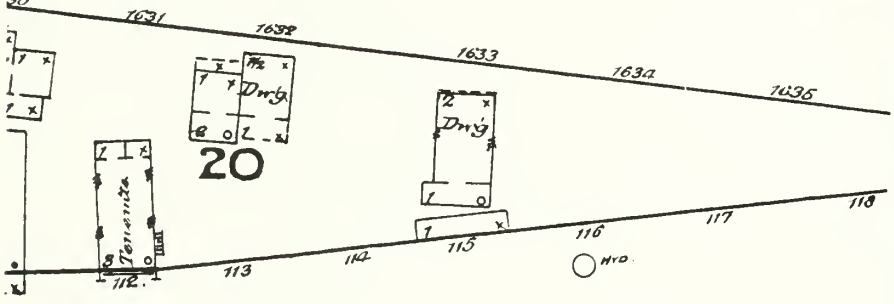
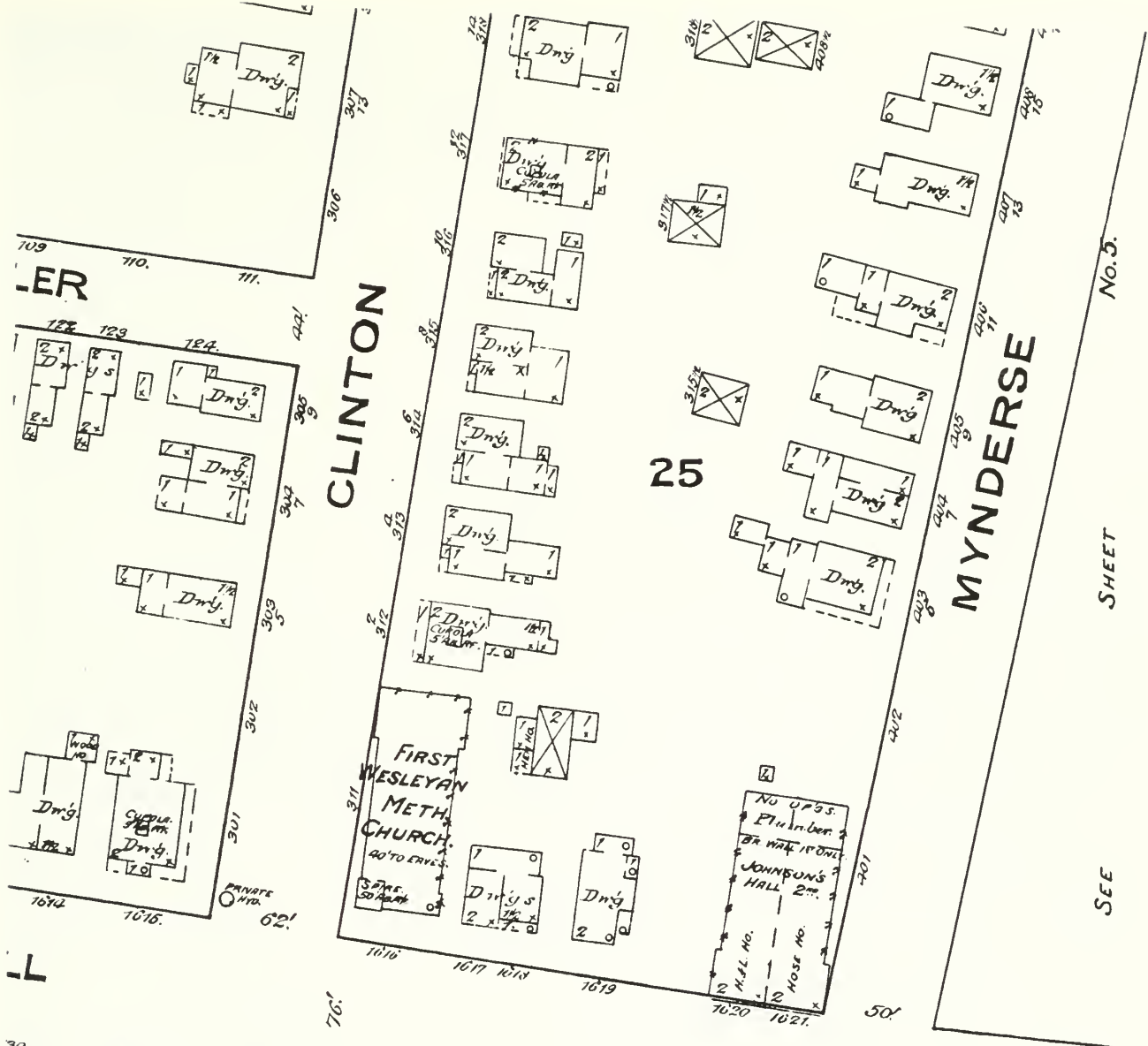

KEY

3	FIRE WALL 6 IN. AB. ROOF
12	" " " "
18	" " " "
1	FRAME PARTITION
1	OPENING & IRON DOOR
1	WINDOWS - SHUTTERS
1	STABLE
1	WINDOW IN 1 ST STORY
1	" 1" & 3"
1	" 2" & 4"
Bldgs colored yellow	ARE FRAME
Red	BRICK
Blue	STONE
Grey	IRON
Brown	ADUBE
Green	SPECIALS
(C)	MARKED (C) ARE CLOTH LINED
(S) (H)	INDICATE RELATIVE HEIGHTS
ALTERNATE STREET NO'S	ARE ACTUAL
CONSECUTIVE	" " ARBITRARY
BROKEN LINE NEAR BLDG	WOOD CORNICE
SOLID	" " METAL

Illustration 25. Charles Chamberlain Johnson. SFHS #377.

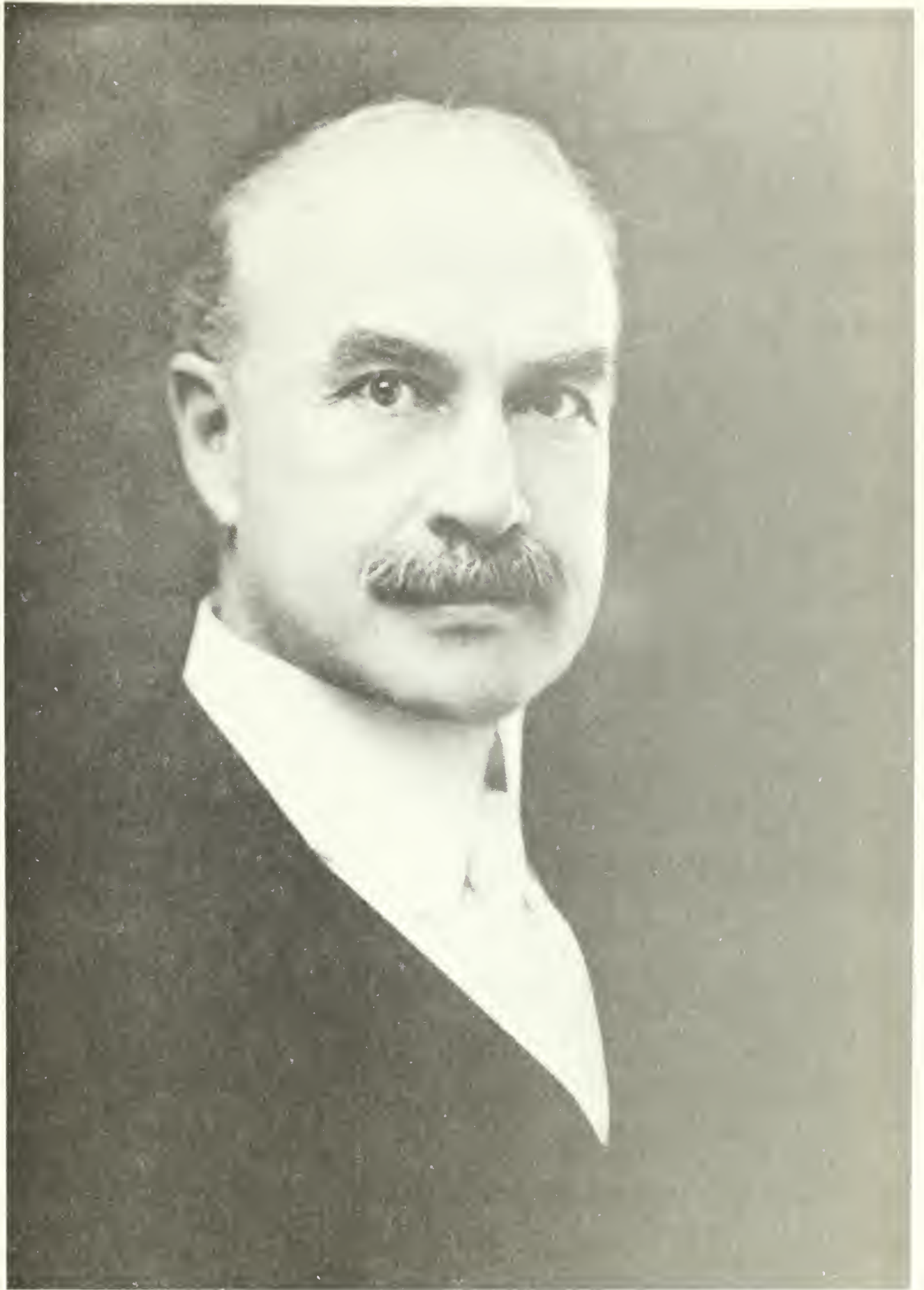

Illustration 26. Great Fire July 30, 1890. SFHS #719.



Illustration 27. Corner of Fall and State Sts. (July 1890) SFHS #713.



Illustration 28. Corner of Fall and Mynderse Sts. (no date provided) Note: Corner of opera house is on the left. SFHS #644.

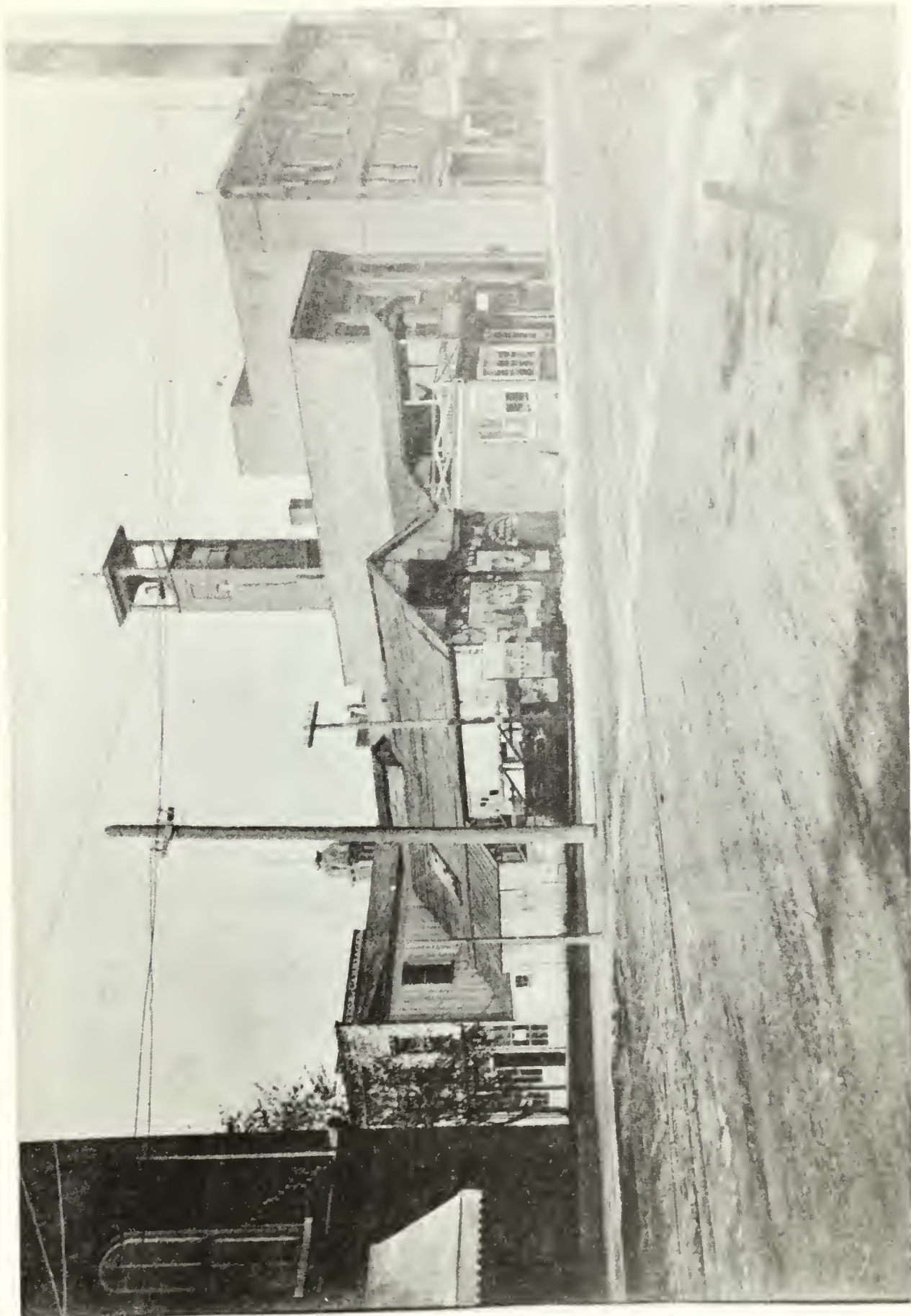

Illustration 29. Johnson Opera House. Photograph courtesy Seneca Falls Reveille.



Illustration 30. Corner of Fall & Mynderse Streets. (early 1920s) SFHS #2379.



Illustration 31. "Bon-Ton Minstrels" Handbill. Janet M. Cowing
Scrapbook 30 1850-1912 SFHS.

Johnson Opera House, **May 5**
Wednesday Eve'g,

M BON-TON **S** **MINSTRELS**

Benefit Library Fund!

PROGRAMME

FIRST PART.

BONES MR. GLENN, MR. ROTHWELL, MR. HARRISON,	* Interlocutor MR. WINKLE.	TAMBOS MR. MOSHER MR. RUMSEY MR. POLLARD
--	-------------------------------	--

Ninth Battallion on Parade..... Chorus
Put me off at Buffalo..... Mr. Rumsey
Thou Art my Own..... Quintette
Dar's a Watermelon Spottin' down at Johnson's..... Mr. Glenn
My First and Only Love..... Mr. Story
De Disappointed Coon..... Mr. Mosher
The Church Across the Way..... Mr. McBride
Ma Lulu..... Mr. Rothwell
Time Will Tell..... Mr Wells

— Grand Finale —

Policeman's Chorus from Pirates of Penzance.

OLIO

CLARINET SOLO,

Mr. Reals.

FRED DUELL,

in Cannon-Ball Pastimes.

DUNNIGAN & MURPHY,

in their Refined Clog Specialties.

GEORGE WINKLE,

New Talk on Woman's Rights.

CLAUDE PALMER,

in Feats of Strength.

THE BON-TON OCTETTE,

In Vocal Selections.

POW & LYNCH,

in Silence and Fun

ORCHESTRA UNDER THE DIRECTION OF
MR. JOHN DAVIS.

Admission 25c. Reserved Seats 35c and 50c.

Seats now on sale at Hull's Newsroom.

Illustration 32. "The Klondike Johnson Opera House Tattler" Handbill.
Archives Collection 32 Recreational and Performing Arts Collection, Box 1,
Folder 3, SFHS.

THE KLONDIKE JOHNSON OPERA HOUSE TATTLER

Seneca Falls N. Y., January 8, 1898.

Season '97-98.

CUMMINGS

THE HATTER

always keeps abreast of the times with the latest New York styles in

Shirts, Collars and Ties

at lowest prices. Remember the only haberdasher here is

CUMMINGS.

The Celebrated Lake Erie Wines

which are made under government supervision and this means that they are strictly pure, as heavy penalties are imposed upon persons adulterating such wines. For purity and medicinal purposes they cannot be excelled in any country in the world.

FOR FAMILY USE

we quote the following prices for four year old stock:

Port, Claret, Sweet Catawba, Tokny, Sweet Ionia,
25c per quart, 90c. per gallon.

J. D. FAYE, the proprietor and manufacturer of the wines will give \$1000. reward for the detection of any artificial coloring or flavorings in any of these wines. FOR SALE ONLY BY

W. H. ADKINSON, 14 State St., Seneca Falls.

Don't fail to call at
PRESTON'S BOWLING ALLEY and BILLIARD PARLOR tomorrow night in the Johnson Opera house Block.

OPERA HOUSE STAFF.

E. J. FORBES - - - Manager & Treasurer
J. C. BANKS - - - - - Press Agent
F. DeREAMER - - - - - Stage Carpenter
C. C. COONS - - - - - Chief Usher
LOUIS PLACE - - - - - Master of Props.

THE DISTINGUISHED ACTRESS

Mlle. RHEA,

In an entirely new Napoleonic play entitled

"THE EMPRESS,"

...with....

Mlle. RHEA as JOSEPHINE

....and....

Mr. Wm. Hanis as Napoleon Bonaparte

Prince de Talleyrand.....Frederick Vroom
Henri de Chantillon.....Lauren Rees
Santino, a Corsican.....Walter Lenox
Cambaceres, Arch Chancellor.....Fred C. Hoey
Prince Czerinchoff, Russian Ambassador....Ferdinand Wilson
Bertrand, Marshal of the Palace.....Robt. Whittier
Berthier.....James Dunn
Marie Louise, second wife of Napoleon.....Miss Lenox
Violette de Saix.....Miss Vaughan
Madame Bertrand.....Miss Mignon Fulton
Mlle. Jacquelin.....Miss Ellen Fulton
Mlle. Felicie.....Miss Sheridan

SYNOPSIS OF SCENES.

ACT I.

1809—Garden of the Tuilleries. The return from Wagram.
The Empress of France.

ACT II.

The Divorce

ACT III.

1812—The Masked Ball. Marie Louise

The Vision.

ACT IV.

1814—Fontainebleau. The abdication of Napoleon.

ACT V.

1814—Malmaison. The death of Josephine.

J. E. O'KEEFE

WINE AND LIQUOR STORE.

Imported Keywest and Domestic Cigars and Smoking Articles.

BOWLING ALLEY ATTACHED

SALGMAN & SAFLEY,

TAILORS.

We handle only the FINEST Woolens.
We employ only EXPERIENCED workmen.
And our PRICES are LOWEST in the city. We also do all kinds of CLEANING, PRESSING and REPAIRING
Over Waller's Hardware Store.

NEW BAKERY.

New Confectionery Store.

NEW LUNCH ROOM.

After the show call at Engler's New Lunch Room at No. 10 State street and get a lunch before going home. Everything in season can be found at this place.

Fresh baked goods and confectionery can be found constantly on hand at this place. Don't forget the number.

10 State St., Opera House Block.

WM. A. ENGLER.

Illustration 33. "Johnson Opera House Programme The Legend of Don Munio" Handbill. Janet M. Cowing Scrapbook 30 1850-1912 SFHS.

JOHNSON OPERA HOUSE

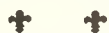

PROGRAMME

FRIDAY EVENING

JAN. 15, '97.

THE LEGEND OF

DON * MUNIO



TO BE SUNG BY THE

Choral Union † † †

OF SENECA FALLS, N. Y.

CHARACTERS REPRESENTED.

~ ~ ~

DON MUNIO	- - -	WILLIAM SCHOONMAKER
DONNA MATIA, his wife	- - -	MRS. COURTENAY ROTHWELL
ESCOBEDO, chaplain	- - -	CHARLES McBRIDE
ABADIL, a Moorish prince	- - -	JAMES SCHOONMAKER
CONSTANZA, his betrothed	- - -	ESTELLA BLAKNEY
RODERIGO, a messenger	- - -	F. TRACY WELLS
Chorus of Huntsmen, Retainers and Female Dependents.		

DIRECTOR	- - - - -	PROF. J. M. CHADWICK
PIANIST	- - - - -	MISS WILHELMINA BROWN

- No. 1—Chorus of Huntsmen and Retainers. Early morning
Court yard of Don Munio's castle.
- No. 2—Recitative and Aria. The castle of Don Munio. Donna
Maria alone in her chamber. Toward sunset.
- No. 3—The Responses and Aretta. Evening. The chapel of
the castle. Escobedo, the chaplain, with the women,
and such retainers as have not followed their master
on his expedition. Conclusion of the vesper service.
- No. 4—Chorus—Ava Maria.
- No. 5—Recitative and Aria. Morning in the forest. Don
Munio alone.
- No. 6—Recitative. Don Munio.
- No. 7—Chorus. (Female voices.) Strains of a Moorish march.
Females of the Moorish cavalcade singing as they
journey.
- No. 8—Chorus. Don Munio's retainers make their appearance
from all sides, wholly surrounding the Moors.
- No. 9—Recitative and Aria. Abadil. Don Munio. "The En-
treaty."—Abadil.
- No. 10—Recitative and Interraazzo. "The Ransom."
- No. 11—Chorus of Moors and Christians. Abadil and Con-
stanza. Chorus.

PART II.

- No. 12—Recitation and Aria. Abadil. The day preceding the
nuptials. A terrace of Don Munio's castle. Sunset
Abadil awaiting Constanza.
- No. 13—Chorus. The chapel choir chanting the evening hymn.
- No. 14—Duet. Abadil and Constanza. Night. The terrace of
the castle. The Moorish lovers.
- No. 15—Chorus. The festivities following the marriage.
- No. 16—Bolero, for orchestra.
- No. 17—Quartette—Don Munio, Donna Maria, Abadil and
Constanza.
- No. 18—Duet. A chamber in the castle. Don Munio and
Donna Maria
- No. 19—Battle hymn. (Male voices.)
- No. 20—Chorus. The chapel of the castle. Choir chanting
the dirge for the dead.
- No. 21—Escobedo, with chorus. The chaplain addresses those
assembled.
- No. 22—Roderigo. The message from Palestine.
- No. 23—Chorus. Finale.

Illustration 34. "Select Masque Ball" Handbill. Archives Collection 32
Recreational and Performing Arts Collection, Box 1, Folder 3, SFHS.

Select Masque Ball.

You are cordially invited to attend a Select Party,
to be held at

Johnson Opera House, Seneca Falls.

Friday Evening, January 28th, 1898

UNDER THE AUSPICES OF THE SILSBY HOSE CO. NO. 2.

MUSIC BY THE ELITE ORCHESTRA:

WILLIAM BLAKENEY, CHARLES SAVAGE, WILLIAM SAVAGE,
FRANK FRANTZ, ELBERT W. FREELAND.

GRAND MARCH AT NINE O'CLOCK.

MASQUERS MUST PRESENT INVITATION AT DOOR.

Illustration 35. "Temple of Fame" Handbill. Archives Collection 32
Recreational and Performing Arts Collection, Box 1, Folder 3, SFHS.

Illustration 36. "David Garrick" Handbill. Janet M. Cowing Scrapbook SFHS.

CLIFTON MALLORY'S
MAGNIFICENT PRODUCTION

**David
Garrick**

JOHNSON OPERA HOUSE *1906*
Monday and Tuesday Evenings, Nov. 12 and 13

Management Woman's Relief Corps *1906*

CAST

David Garrick.....Clifton Mallory
Ada Ingot.....Genevieve Dean
Simon Ingot.....Fred Canfield
Richard Chivy.....Fred Spaid
Samuel Smith.....Ves Norcott
Mrs. Samuel Smith.....Mae Hurd
Reginald Jones.....Charles Norcott
Araminta Brown.....Mary Somers
Thomas.....George Coons

COSTUMES—English Court, period 1742.

SCENERY—By Sosman & Landis.

Incidental Music by Mrs. Clifton Mallory, Musical Director

SYNOPSIS

ACT 1—June 1742. Time—Morning and Afternoon.
Scene—Saloon in Ingot's House.

ACT 2—Time—Afternoon and Evening. Scene—
Same as Act 1.

ACT 3—Time—Early the Next Morning. Scene—
Apartments of David Garrick.

Note—Owing to the peculiar ending of the third act the audience is requested to remain seated until the final fall of the curtain.

MUSICAL SPECIALTIES

Which will precede the action of the play.

SAILORS' FROLIC

Jeanie Young	Anna Best	Anna Norton
Gladys Davis	Alice Penoyer	Gertrude Sawyer
Florence Magill	Olive Sangster	Gladys Ingles
Ethel Devlin	Mildred Fegley	Valetta Craft
Frances Dooley	Bertha Myers	Ada Armstrong
Helen Royston	Ethel McMellian	Susie Philo

GIRLS' MILITARY DRILL

	Alice Dooley, Captain.	
Lena Gaston	Mary Plunket	Ruth Alleman
Leta Fahrenwald	Teresa Lynch	Emma Laties
Margaret Ferguson	Mary DeLapp	Marie Rooney
Anna Bordner	Susian Litsenberger	Ethel Flanagan
Agnes Muldoon	Florence Runge	Dapna Terney
Charlotte Barton	Susie Aitken	Gennie Dempsey

SUSIE'S BAND

	Jeanette Brown, Drum Major.	
Ethel Hurd	Marguerite Bracket	Genevieve Cunningham
Rose Oakes	Rose McGraw	Pearl Simons
Helen Hurd	Bertha Bogardus	Martha Scollins
Florence Morris	Edna Williams	Marie Reagan
Pearl Bogardus	Elma Stanton	

Reserved Seat Sale opens Monday A. M., Nov. 12 at Hull's

PRICES, - 25, 35 & 50 CENTS

Illustration 37. "Our New Minister" Handbill. **Archives Collection 32**
Recreational and Performing Arts Collection, Box 1, **Folder 3**, SFHS.

Johnson Opera House

Friday Evening Feb. 23, '12

Joseph Conyer's Production

America's Greatest Character Play

Our New Minister

A Story of the Hardscrabble Folks, by Denman Thompson
and George W. Ryer, authors of "The Old Homestead."

CAST OF CHARACTERS:

Thaddeus Strong, our new minister Garland Gaden
Lem Ransom, a reformed convict M. H. Harriman
Curt Ho'ten, on the fence Charles F. Adams
Obadiah Blurton, with settled opinions John E. Gilbert
Sylvanus Bartlett, postmaster and storekeeper Fred Clark
Calvin Abdal, our old minister L. Irwin
Hannibal Chapman, a pretender Will D. Ingram
Sheezicks, a Billy Baxter lad from New York
..... Edgar W. Ballou
Jack Frazier, an escaped convict L. Irwin
Joe Ransom, brother to Nance Master Hazelton
Nance Ransom, Lem's daughter Carol Warren
Dorcas Tattleby, name and nature alike Hattie French
Esther Strong, our new minister's sister Ruth Hayes
and
DARIUS STARTLE, a country detective
..... JOSEPH CONYERS

SYNOPSIS OF SCENES:

Act I—Front of village store and postoffice.
Act II—Library and study of Thaddeus Strong.
Act III—Kitchen and workshop of Lem Ransom.
The scene is laid in Hardscrabble, N. H. Six weeks
are supposed to elapse between Acts I and II; three weeks
between Acts II and III.

Big Picture Show

To-morrow and all next week

Matinee every day at 3:00. Night 7:15

Illustration 38. 60th Anniversary of 1848 Convention SFHS #2896.

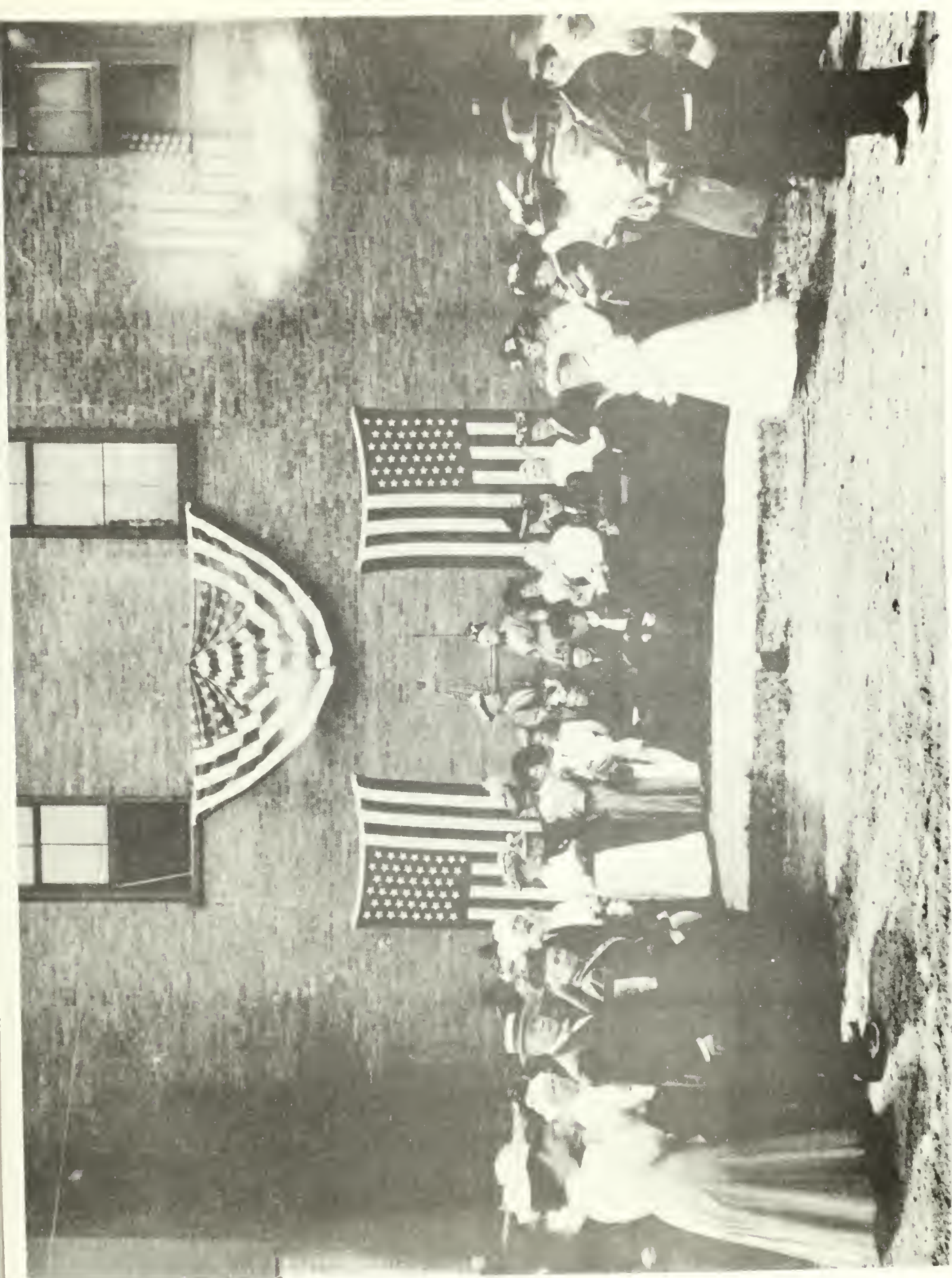
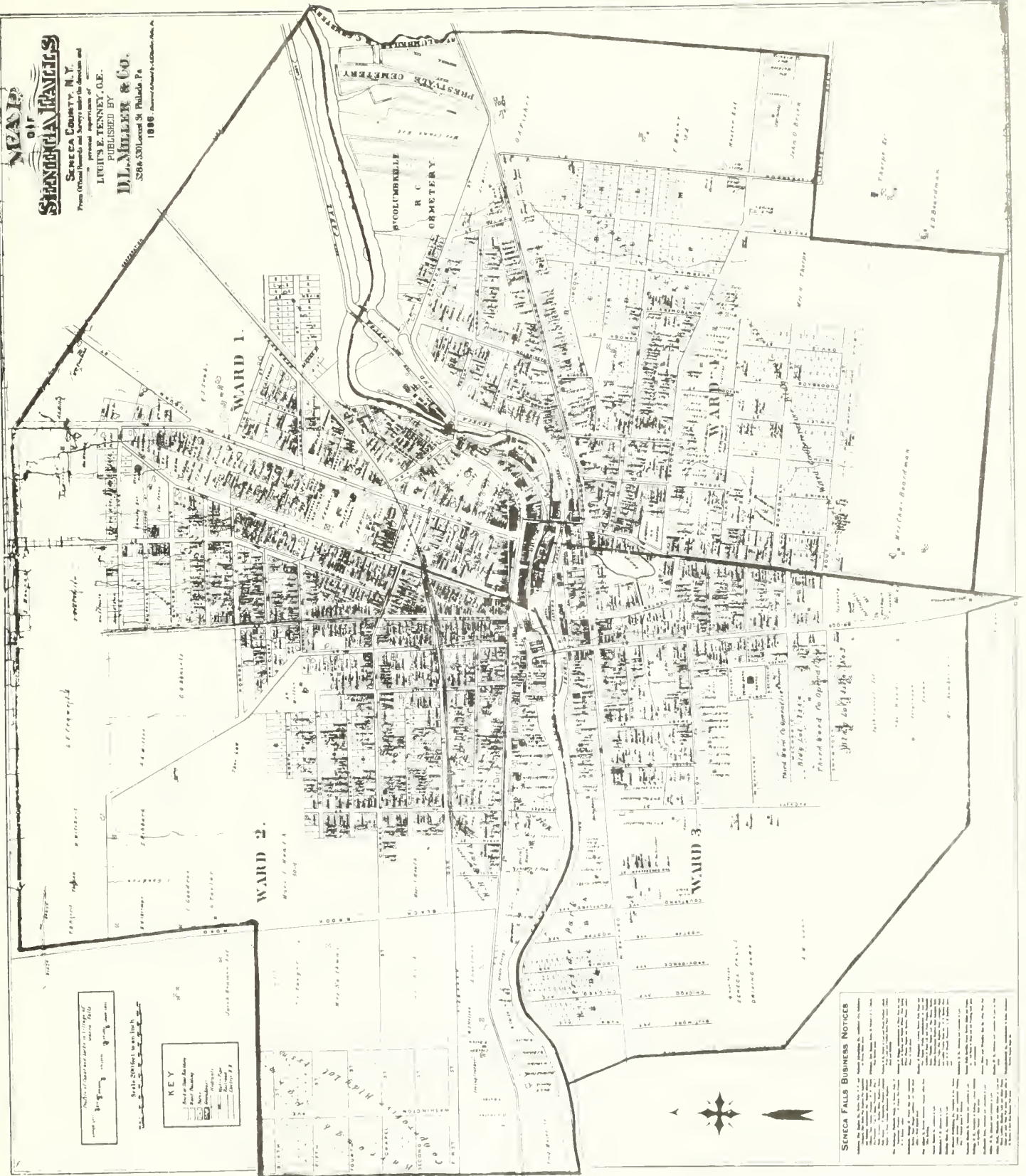

Illustration 39. 1896 Seneca Falls Map.

NEAR
OF
STANDARD MAPS
 SENeca COUNTY, N.Y.
 From Official Records and Surveys made for the State and
 personal experience of
LUDWIG E. TENNEY, O.E.
 PUBLISHED BY
W. L. MILLER & CO.
 529 & 531 South 9th Philadelphia, Pa.
 1886. (Revised January 1st 1886)



SENECA FALLS BUSINESS NOTICES
 The Seneca Falls Chamber of Commerce has been organized for the purpose of promoting the general interests of the town and county, and of acting as a medium of communication between the various business concerns of the place. The Chamber of Commerce is composed of the following members: [List of names and addresses follows]

Illustration 40. 1896 Seneca Falls Map, Detail.

Illustration 41. 1897 Sanborn Map, Detail.

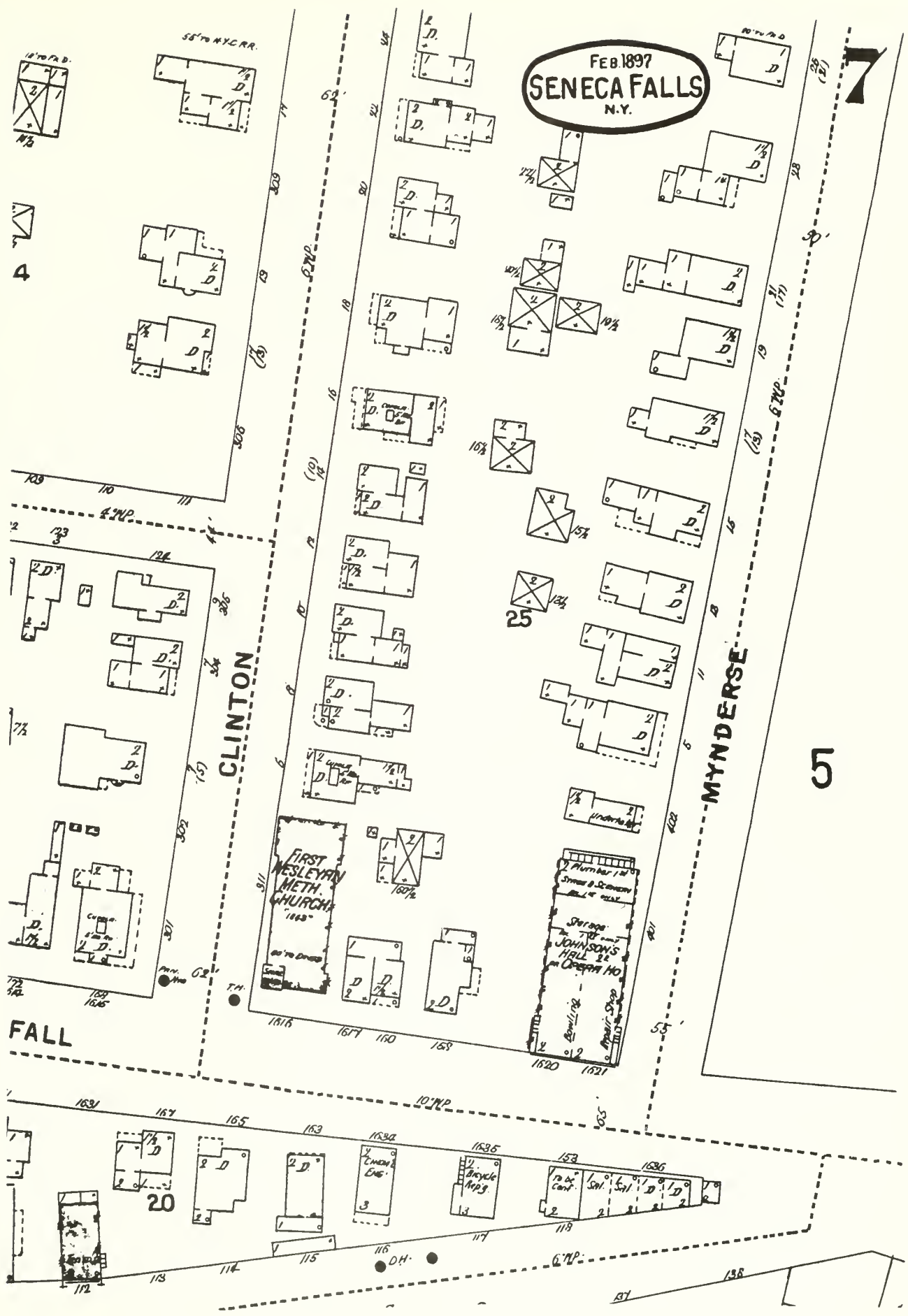
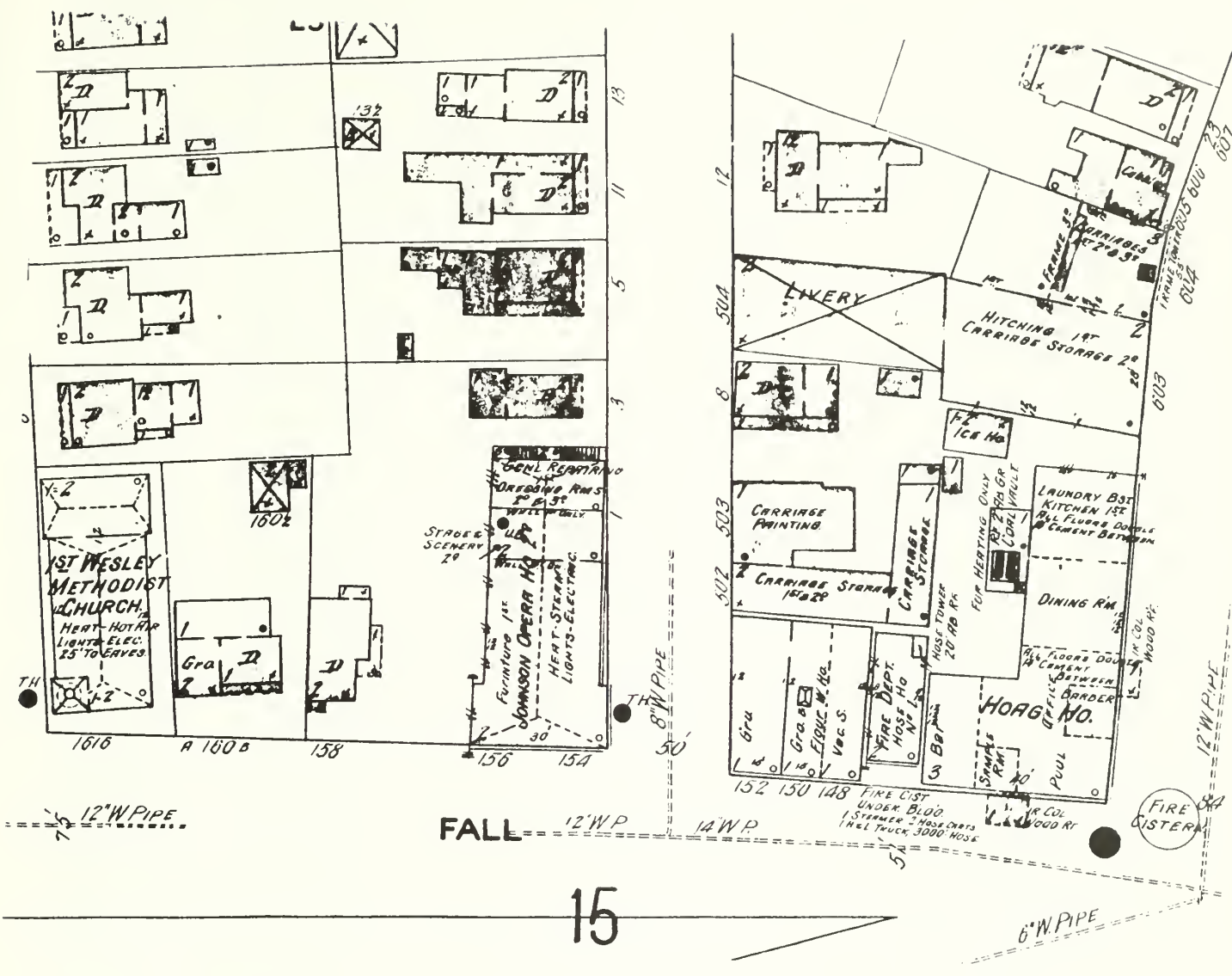

Illustration 42. 1911 Sanborn Map, Detail.



KEY	
NUMBER OF STORIES 3	FIRE WALL 6IN ABV ROOF
SHINGLE ROOF	METAL CORNICE
COMPOSITION RT & SLATE OR TIM RT & O	FIRE WALL 12IN ABV ROOF
	WOOD CORNICE
	FIRE WALL 18IN ABV ROOF
	FRAME PARTITION
	OPENING WITH IRON DOOR
	" " "STANDARD" "
	IRON DOOR
	WINDOWS & IRON SHUTTERS
	WINDOW - 1ST STORY
	WINDOWS 1" & 3RD STORIES
	" " 2ND & 4TH "
	STABLE
BUILDINGS COLORED	YELLOW ARE FRAME
..	RED BRICK
..	BLUE STONE
..	GRAY IRON
..	BROWN ADOBE
..	GREEN SPECIALS
(5) (27)	INDICATE RELATIVE HEIGHTS
+	FIRE STATION, AS SHOWN ON KEY MAP
ALTERNATE STREET NUMBERS ARE ACTUAL	
CONSECUTIVE STREET NOS ARE ARBITRARY	

Illustration 43. Possible Johnson Opera House Interior (no date, name of production not known, only two participants identified) SFHS #2759.

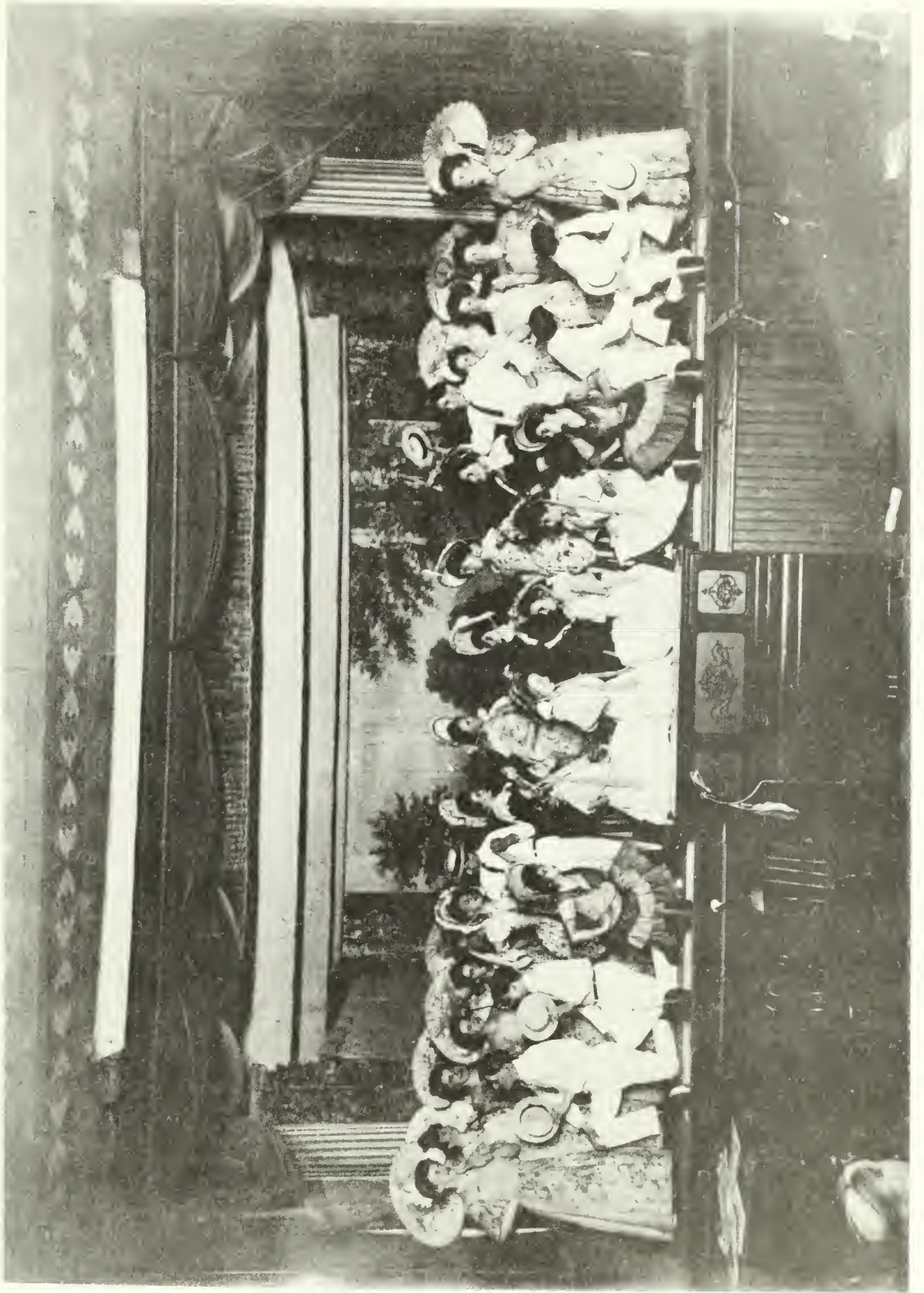

Illustration 44. Interior of the Johnson Opera House when it was used as a roller skating rink, ca. 1907. WORJ files.

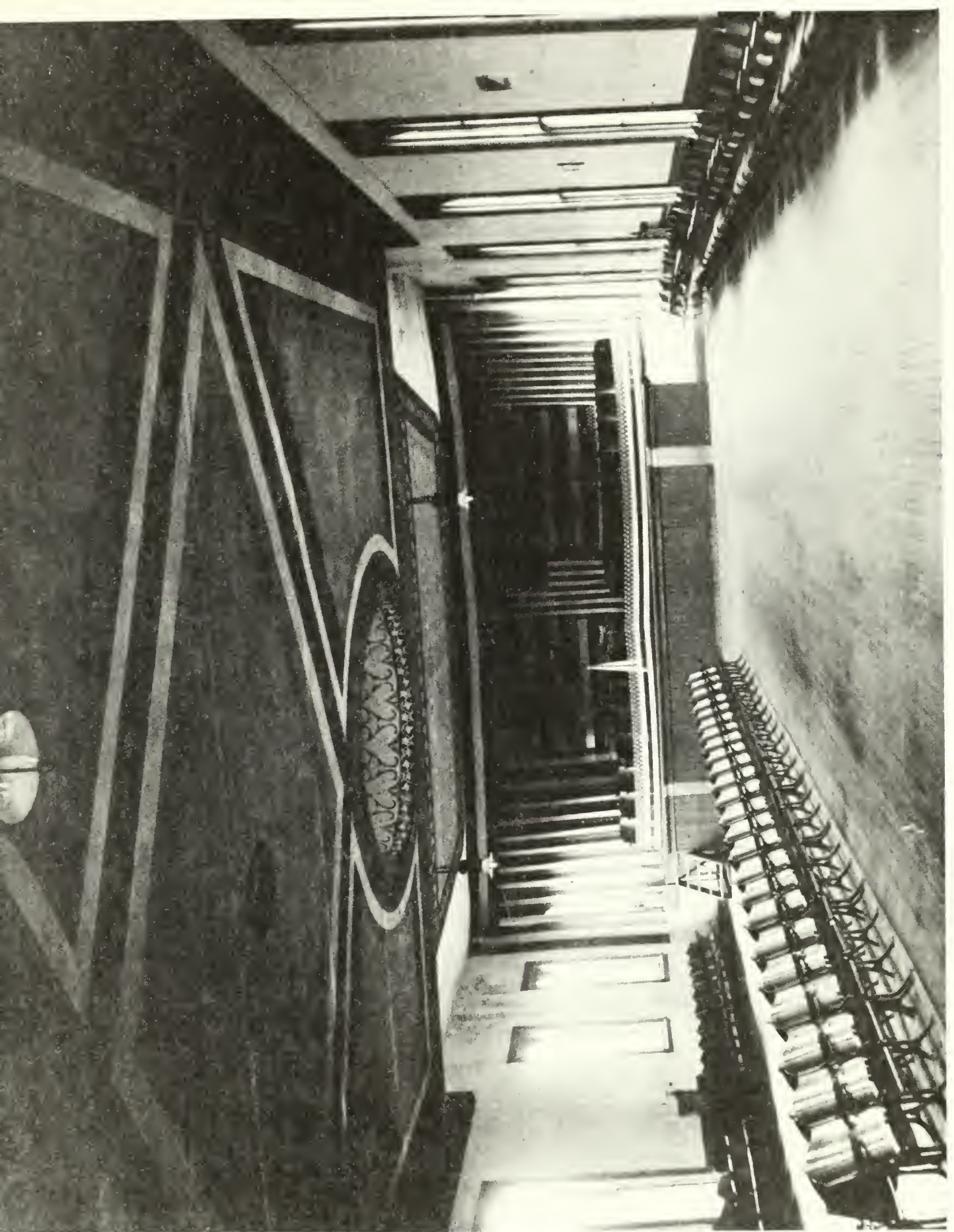

Illustration 45. Powers' Furniture Advertisement, Reveille, April 19, 1907.

Re-Construction Sale Still Continues.

Mrs. D. I have read in this paper about C. H. Powers Re-Construction Sale. Just for the fun of the thing I went into his store last week? Well say, he is certainly doing a big business and selling just as he says.

Mrs. B. Oh yes. I bought a Sideboard that was marked \$33 for \$25 all quartered oak, polish finish, large plate glass mirror 18x40 bevel edge, one drawer lined for silver, cast brass handles, etc. Wish you would come in and see it. He is selling the entire stock at prices that beat all competitors.

C. H. POWERS, Johnson Opera House Block

FURNITURE, CARPETS and RUGS.

Illustration 46. Powers' Furniture Advertisement, Reveille, September 25, 1908.

THINK it OVER

We are selling a solid Oak Dresser, glass 24x28
for \$11 98.

The best Woven Wire Spring for	\$3.50
IXL. Kitchen Cabinets for	\$12.00
A good Round Top Table for	\$10.80
Set of Oak Dining Chairs for	\$9.00
Childs' Crib Beds for	\$6.75
All Steel Cots \$3.00	Cots \$1.50

Goods Marked In Plain Figures.

C. H. POWERS, Opera House Block.

Illustration 47. Fall Street, Seneca Falls, N.Y. looking east from Johnson Opera House, ca. 1900 SFHS #3667.



Illustration 48. Fisher Theatre ca. 1920 (Powers' Furniture located next door) SFHS #2585.

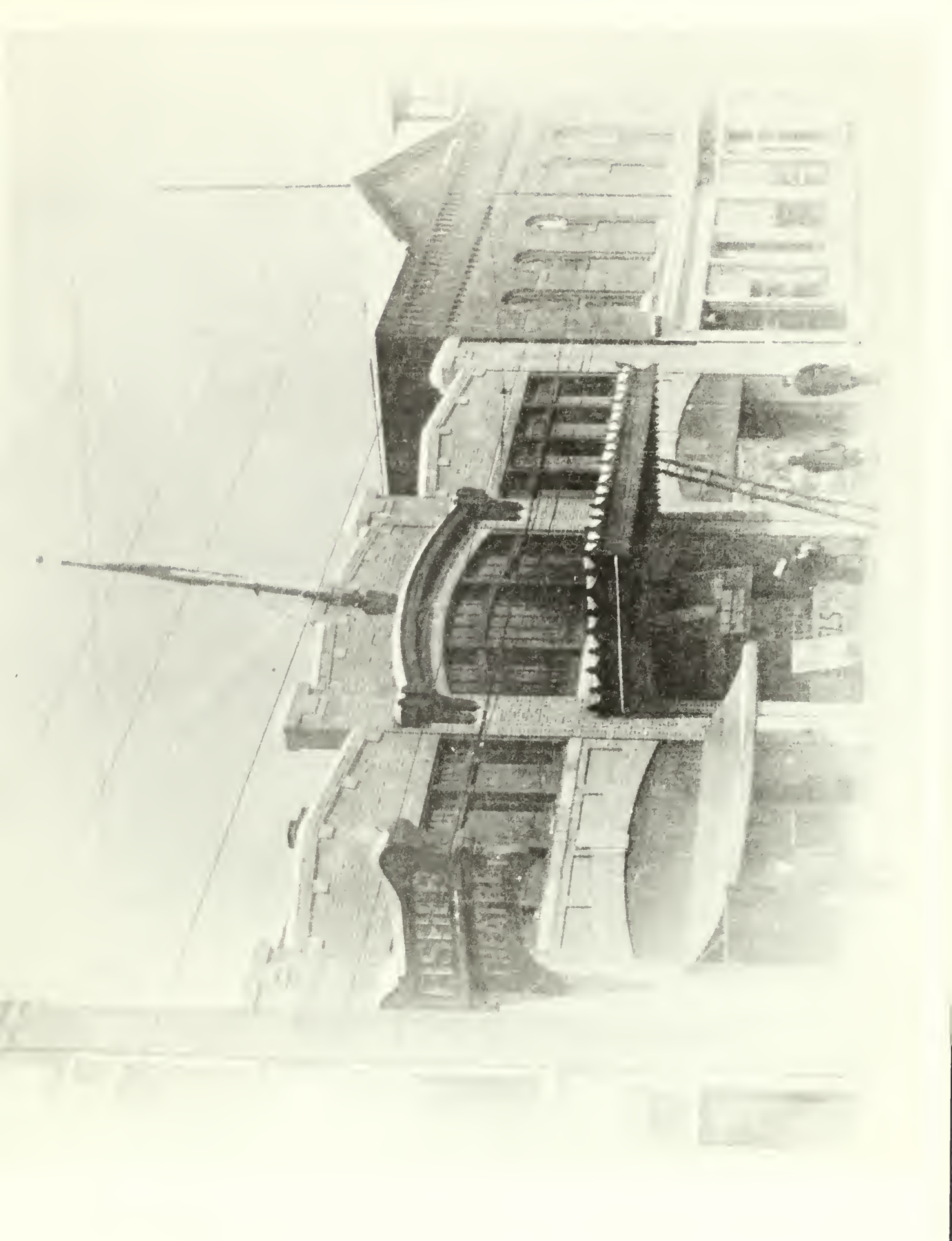

Illustration 49. Powers' Furniture Advertisement, Reveille, February 4, 1916.

Go in and buy Some article
of FURNITURE at
Powers'
Special Reconstruction Sale

You need something in his line. He is selling out a lot of it. You will not recognize the old place after improvements are made, as he intends to have the largest and most attractive store in Seneca County.

Wake Up People! Do It For Seneca Falls!
That's It! Why Not!

Illustration 50. Theatre District, Seneca Falls, N.Y. ca. 1919 SFHS #3585.

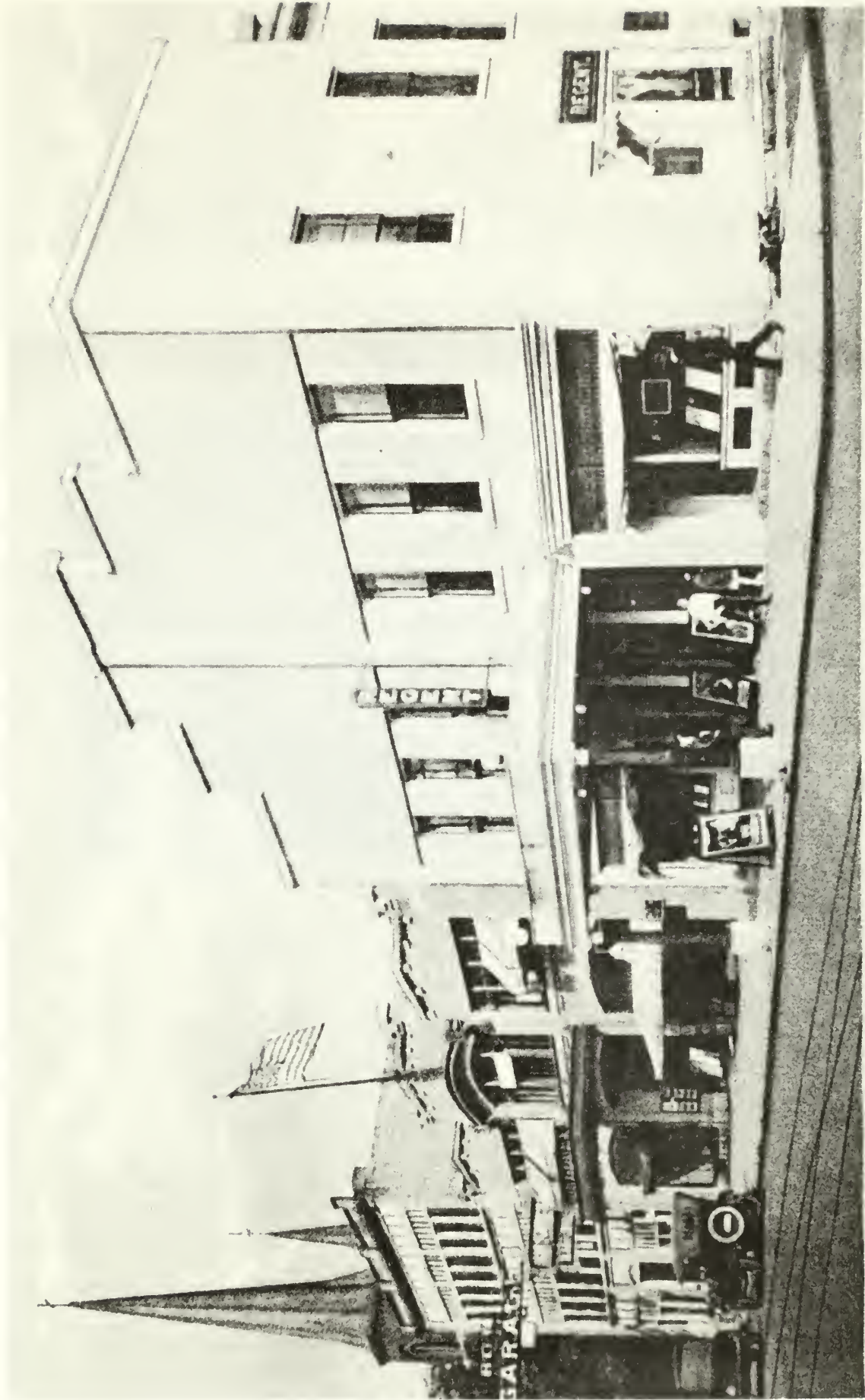

THEATRE DISTRICT, SENECA FALLS, N. Y.

Illustration 51. Regent Theatre, Seneca Falls N.Y. WORl files.



REGENT THEATRE, SENECA FALLS, N. Y.

Illustration 52. "Monster Bazaar and Entertainment at the new Regent Theatre" Advertisement. Reveille, November 30, 1917.

GET YOUR TAG

ALL SENECA COUNTY BENEFIT CAMP RECREATION FUND

Sanctioned by Seneca County Home Defense Committee

The Goulds Defense Guards

WILL GIVE A

Monster Bazaar

and Entertainment

**AT
THE
NEW**

Regent Theatre

SENECA FALLS

December 7th and 8th

BAND CONCERT 45 **PIECE MILITARY BAND 45**

*Help Bring Cheer to the Boys Who Will
Fight Your Battle*

REGENT THEATRE DONATED BY A. B. HILKERT

Doors Open 7 P.M. Sat. Matinee 2 P.M.

Illustration 53. "Grand Opening of the Regent Theatre" Advertisement.
Reveille, December 14, 1917.

Grand
Opening
of the

REGENT
THEATRE

Thursday
Dec. 20th

WITH ETHEL CLAYTON
in **"Dormant Power"**

ALSO A HOYT COMEDY

Friday
Special Program

MAE MARSH
in **"Sunshine Alley"**

A Goldwyn Production in Six Parts

LATEST AMERICAN WAR NEWS

ALSO A COMEDY

Saturday

JULIA SANDERSON
"The RUNAWAY" In Five Parts

Also **CHARLES CHAPLIN**, the World's Famous Comedian
in the **"FLOOR WALKER"**

A LAUGH FROM START TO FINISH

On OPENING DAY a Complimentary Ticket given with every ticket purchased. Good for one admission any day after, if used before Feb. 1, 1918

Admission, Lower Floor 10c, and 1c war tax; Balcony 15c, and 2c war tax

Illustration 54. Regent Theatre Advertisement, 1918. Reveille,
December 17, 1918.

REGENT THEATRE

**A. B. HILKERT,
Owner.**

FRIDAY and SATURDAY
THEDA BARA
The "SHE-DEVIL"

Watch For

EDDIE POLO

IN

"The Lure of The Circus."

Dec. 27th and 28th.

Illustration 55. Mynderse and Fall Street (Seneca Falls Garage, Inc.) ca. early 1920s
SFHS #3332.



Illustration 56. Seneca Falls Garage, Inc. Advertisement. Reveille,
January 9, 1920.

Let Me Explain Why I Represent the



"Exide" Starting & Lighting Battery

First. I am firmly convinced that the "Exide" Battery is all that the manufacturer claims it to be, in every detail a quality product.

Second. I can sell the "Exide" Giant to my customers and feel satisfied that they are getting a battery which will give them the nearest to 100 percent service which it is possible to build into a starting battery.

Third. I know that the thirty-one years of specialized storage battery building experience that is built into the "Exide" is proof positive that it is the *right* battery, in every sense of the word, for *your* car.

Fourth. I know what the "Exide" Battery has accomplished for hundreds of thousands of car owners the country over. It will accomplish the same for you—"A Sure Start Assured."

Let's Talk It Over—Learn How "Exide" Construction Differs

"Exide" Battery Service

meets any need of any starting battery. If it is a question of a simple test or difficult repair, recharging or rebuilding, "Exide" Battery Service is available. "Exide" Battery Service is founded upon the same quality basis as the "Exide" Battery: its one real purpose is to provide for the individual need of every individual user of any starting battery.



Seneca Falls Garage, Inc.
Our Battery Dept. is in charge of

GEORGE B. GRAVES

Call 155-W.



**LOOK FOR
THIS SIGN**

Illustration 57. Seneca Falls Garage, Inc. Advertisement. Reveille,
April 2, 1920.

AUTO MOVIES

By SENECA FALLS GARAGE, INC.



THERE is something the matter with a man's auto vision if he cannot see that this repair shop is the one that should furnish all the necessary repairs to his auto. Our methods of doing business will help you and your car.

PHONE 155-W

SENECA FALLS GARAGE

COR. FALL & MYNDERSE STS.

Illustration 58. Fred L. Huntington Ford Advertisement. Reveille,
December 1, 1922.

Announcing

Our removal to Cor. of Fall & Mynderse
Sts., on Dec. 5th., will show a New Ford
Four Door Sedan in our new Show Room.
Come in and see it.

Thanking you for past favors and courtesies, I am

FRED L. HUNTINGTON,
Phone 48 **FORD DEALER.**

Illustration 59. Group of people displaying commemorative tablet, 1923. (left to right - Carl Rogers Sr., vice president/general manager, Seneca Falls Rule and Block Co.; Bert G. Mackey; Mrs. Daniel Moran; Dr. Follette, village president; Devillo Pollard, Seneca County assemblyman; Anita Politzer; Earl Clark, publisher of the Reveille; Leonard Stafford, publisher of Seneca County Press. SFHS #2846.



Madison W. Phillips
Seneca Falls, N. Y.

Illustration 60. 1925 Sanborn Map, Detail.

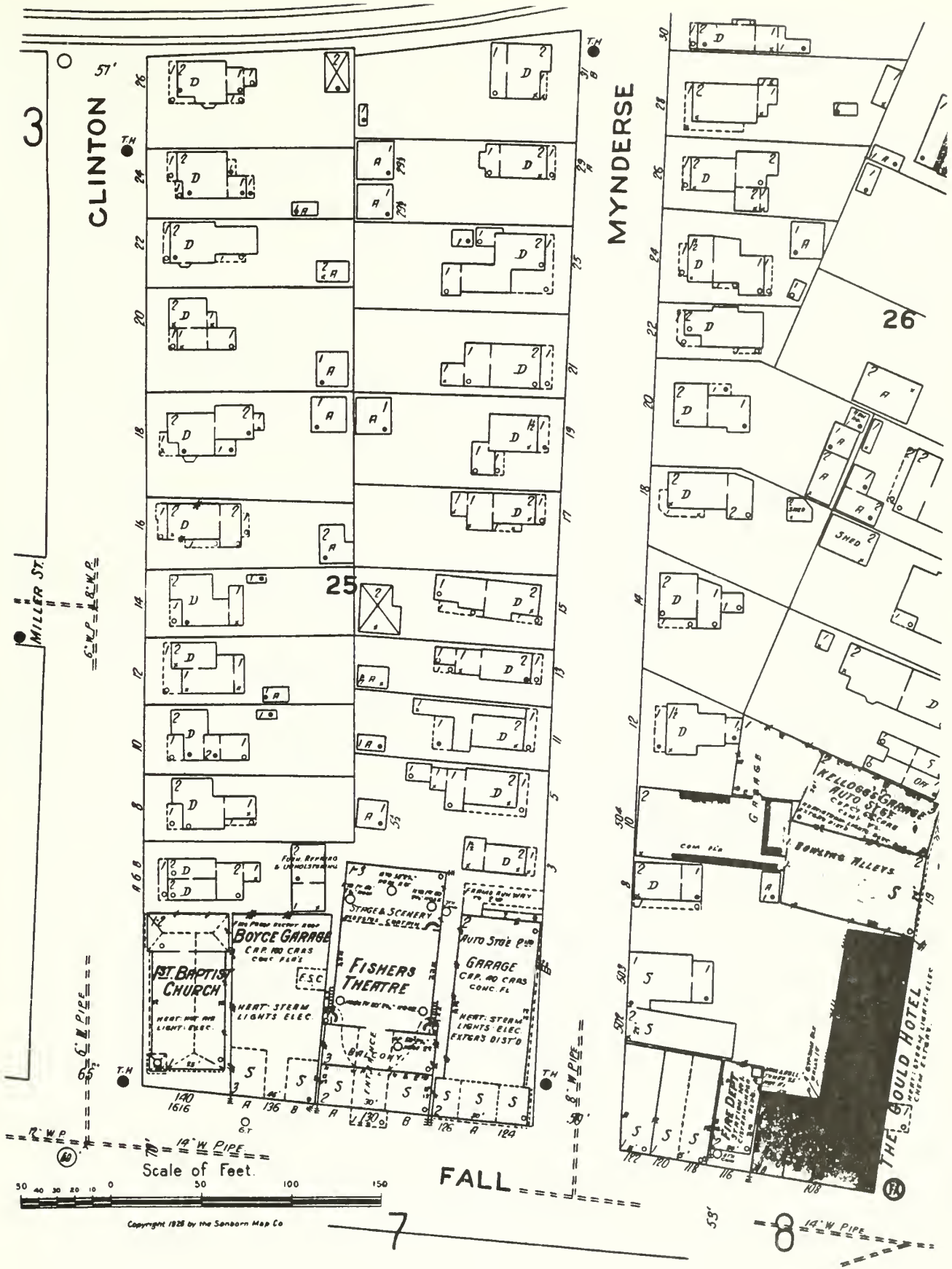

CLINTON

MYNDERSE

FALL

Scale of Feet.

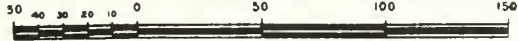

Copyright 1928 by the Sanborn Map Co

Illustration 61. Members of N.Y.S. League of Women Voters attending replacing of tablet at Seneca Falls, 1928 SFHS #2841.



Illustration 62. Ford Garage, WORL files.

Illustration 63. Seneca Falls Sales Co., Inc. Advertisement. 1929
Seneca Falls Directory.



SENECA FALLS
SALES CO., Inc.
124-126 FALL ST.
PHONE 24 SENECA FALLS

Authorized
Cars



Dealers
Trucks

Illustration 64. Ford Garage Detail, WORL files.

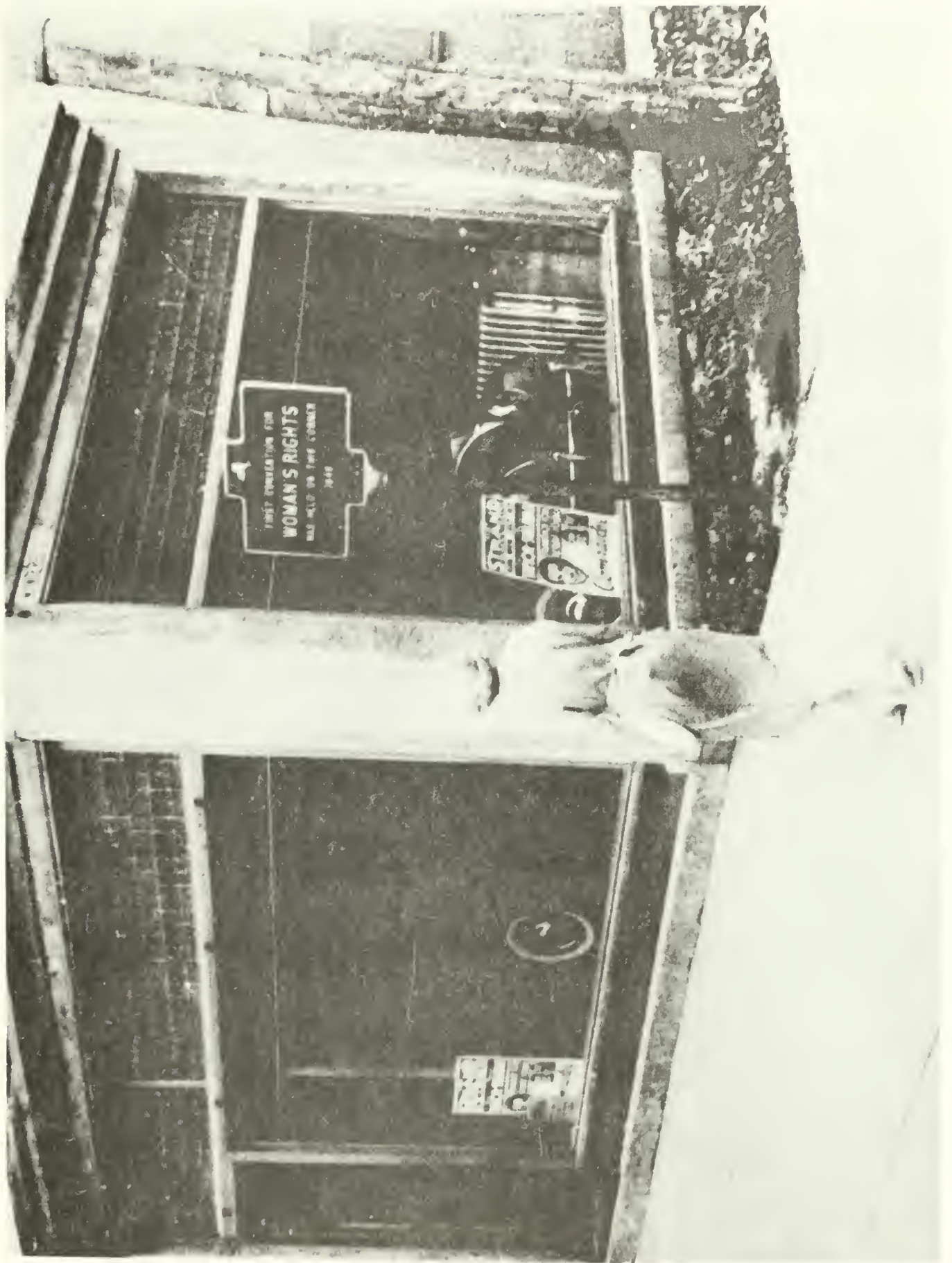
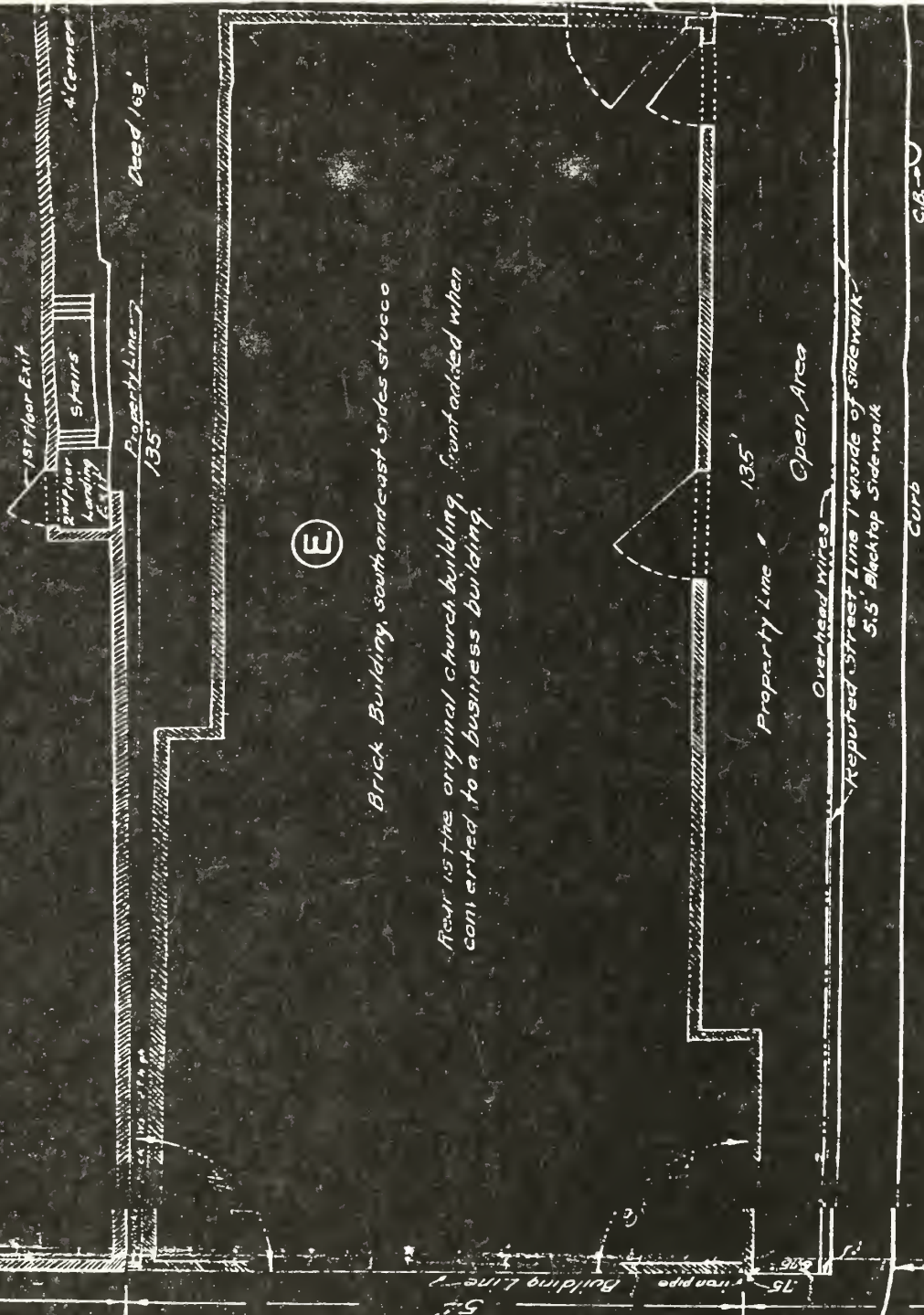
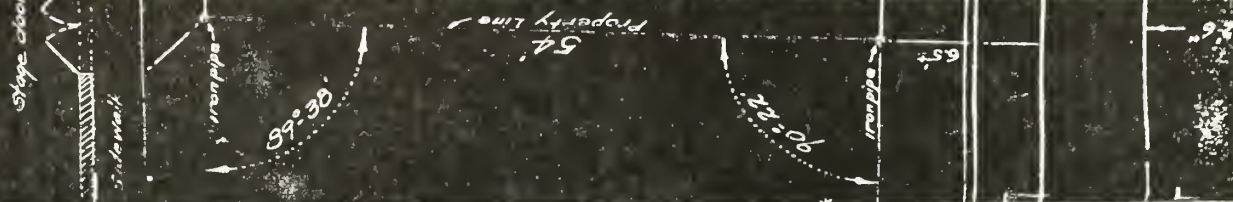

Illustration 65. Lynch plat map of building, 1944, 1944 Map Book 12, p. 15, SCCW.



E

Brick Building, south and east sides stucco

Rear is the original church building, front added when converted to a business building.



STRE

MYNDERSE

Sanitary Sewer

Curb

Open Area

Property Line

Reputed Street Line 1' inside of sidewalk

5.5' Bleektop Sidewalk

Overhead wires

Need leg

4' Center

1st Floor Exit

2nd Floor Landing

Stairs

Stage door

Sidewalk

iron pipe

90°

54'

Building Line

15' iron pipe

15'

49.5'

24'

20'

44'

44'

Illustration 66. 1925 Sanborn Map corrected to 1955, Detail.

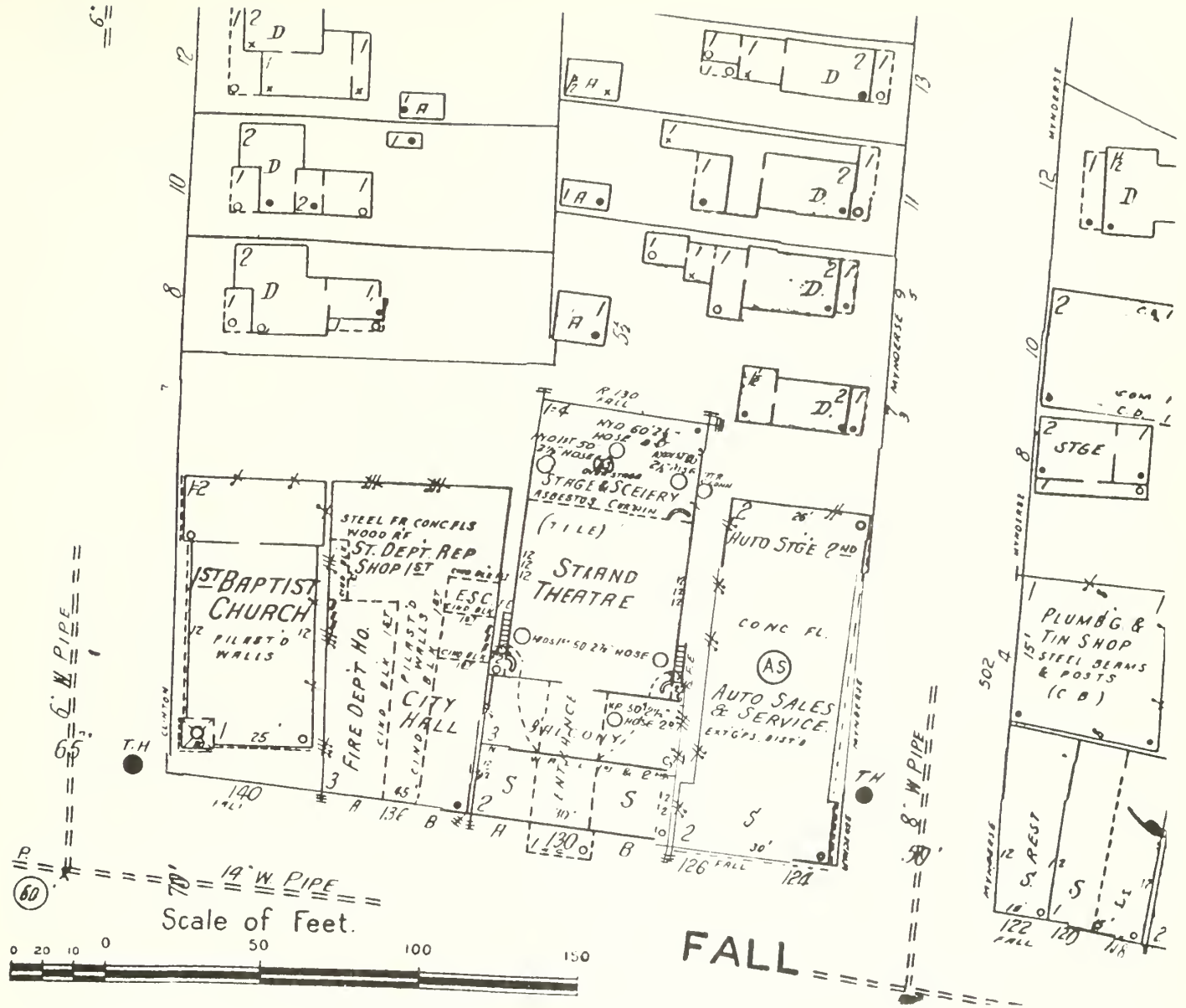

KEY

WINDOWS 123 WITH WIRE GLASS	FIRE WALL 6IN ABV ROOF
NUMBER OF STORES	METAL CORNICE
SHINGLE ROOF	FIRE WALL 12IN ABV ROOF
COMPOSITION RF	WOOD CORNICE
SLATE OR TIN RF	FIRE WALL 18IN ABV ROOF
STEAM BOILER	FRAME PARTITION
OPENING WITH IRON DOOR	OPENING WITH IRON DOOR
" " "STANDARD"	" " "STANDARD"
IRON DOOR	IRON DOOR
WINDOWS & IRON SHUTTERS	WINDOWS & IRON SHUTTERS
WINDOW 1ST STORY	WINDOW 1ST STORY
WINDOWS 1ST & 3RD STORIES	WINDOWS 1ST & 3RD STORIES
" " 2ND & 4TH "	" " 2ND & 4TH "
STABLE (CB) - CONCRETE BLOCK	STABLE (CB) - CONCRETE BLOCK
BUILDINGS COLORED YELLOW ARE FRAME	BUILDINGS COLORED YELLOW ARE FRAME
" " " " RED BRICK	" " " " RED BRICK
" " " " BLUE STONE	" " " " BLUE STONE
" " " " GRAY IRON	" " " " GRAY IRON
" " " " BROWN FIRE PROOF	" " " " BROWN FIRE PROOF
(5) (27) INDICATE RELATIVE HEIGHTS	(S) AUTOMATIC SPRINKLERS
+ FIRE STATION, AS SHOWN ON KEY MAP	+ FIRE STATION, AS SHOWN ON KEY MAP
ALTERNATE STREET NUMBERS ARE ACTUAL CONSECUTIVE STREET NOS ARE ARBITRARY	

Illustration 67. Seneca Falls Sales Co., Inc. Advertisement. Reveille,
January 16, 1948.

New *Ford* Sales & Service Building Opened

Seneca Falls Sales Co., Inc. celebrates completion of modernization program with special "Open House"



Ford Motor Company officials and officers and staff of the Seneca Falls Sales Co., Inc. welcomed hundreds of Seneca County residents at an "Open House" in the company's new sales and service building at Madison and Falls Streets, Seneca Falls, Thursday evening, January 15th. The "Open House" marks the completion of a modernization program started more than a year ago. The new building, with its 100,000 square feet of floor space and new equipment, provides this community with one of the finest motor car, truck and tractor service garages in the United States.



Charles R. Almy
Vice President
General Manager

In inviting the public to inspect the building and equipment, Charles R. Almy, vice-president and general manager of Seneca Falls Sales Co., Inc., said: "Our modernization program was started with only one thought in mind — to provide the most modern, efficient service possible for the owners of Ford motor cars, trucks and tractors in this area. We have left no stone unturned to secure the latest equipment and to obtain a staff of efficient mechanics. We cordially invite you to inspect our department of the establishment."

carburetor, fuel pump, lights and other minor repairs.

The second floor, connected with the ground floor by a large electric elevator, is designed for major motor overhauls, body repairs and painting. The paint booth in one corner is the most modern in the area and the body and frame repair equipment is of the latest design. Heavy and large parts are stored on the second floor with small parts and accessories on the first floor. The hot re-building is heated by steam radiators in the display rooms and hot blowers in the two service departments.

Designed by Wallace P. Beardsley, Auburn architect, the building is constructed by M. S. Matterson, general contractor. The ten story building is brick, concrete and steel, has a frontage of 50 feet on Fall Street and of 100 feet on Mendenhall Street. Display rooms on the first floor are floored with rubber tile, brick walls and woodwork papered and painted in a warm luge.

Directly back of the display room is the operation, washing and minor repair sections of the service department. Designed for fast efficient service, this section handles ignition,

Contractors and supply firms who contributed to the building include: M. S. Matterson, general contractor; De Rosa & Schaertl, mason contractors; Doran Brothers, plumbing and heating; Henry & Cook, painting contractors; Globe Sprinkler Co., Inc., sprinkler system; Warsaw Elevator Co., elevator; Onondaga Supply Co., equipment; The Electric Shop, fixtures and wiring; Syracuse Glass Co., plate glass; Cortland Overhead Door Co., service station doors; Cullum Acoustical Co., floor tile; Workens Paint Headquarters, wallpaper and paint; Central City Roofing Co., roofing installation.

M. S. Matterson
General Contractor

Doran Brothers
Plumbing & Heating
Contractors

Madison Street Seneca Falls, N. Y.

Wallace P. Beardsley

We Are Proud

Seneca Falls Sales Company
New Modern Building
Globe Automatic Sprinkler Co., Inc.
115 Alexander Street
Rochester, 4 N. Y.

**Wordens Paint
Headquarters**

Genesee Street Auburn, N. Y.

**Congratulations
and
Best Wishes**

Onondaga Supply Co., Inc.
Syracuse, N. Y.

Central City Roofing Co.

Seneca, New York

De Rosa & Schaertl
Mason Contractor

101 Cayuga Street Seneca Falls, N. Y.
Telephone: 34-W; 382-J.

Henry & Cook
Painting Contractors

Seneca Falls, N. Y.

Seneca Falls Sales Co., Inc.

Modern Sales & Service Building
is equipped with a
Warsaw Elevator

Warsaw Elevator Co.
Warsaw, N. Y.



Edwin Johnson
Car Service



C. Spencer
Car Service



Andrew Storms
Body & Paint Dept.



Henry Wilbey
Service Department



Fay Darcy
Tires and Equipment
Sales



Charles Edmunds
Parts Manager



Louis Jones
Transportation

Illustration 68. Seneca Falls Laundromat Advertisement. Reveille,
May 17, 1961.

BOY SCOUT DAY

Troops

70

73

80

88



Packs

73

80

88

AT

Seneca Falls Lundramat

Corner Of Fall & Mynderse St.

Saturday June 3rd 7:AM.-8:PM.

Entire Receipts For The Day To

Be Donated To The Boy Scout

Troops Of Seneca Falls

Illustration 69. Seneca Falls Laundromat Advertisement. Reveille,
July 29, 1964.

SPECIAL LOAD DRY CLEANING

12 LBS. \$1.75

10 LBS. \$1.50

THUR., FRI. and SAT. only during sidewalk sales days. Leave your loads and bring as many as you wish. Our operators do all the work. Machine time is only 23 minutes.

SENECA FALLS *Laundromat*

Illustration 70. Seneca Falls Laundromat after purchase by National Park Service, 1985.



ANNOTATED BIBLIOGRAPHY

PRIMARY SOURCES MANUSCRIPT MATERIALS

Seneca County Courthouse

Civil Actions and Special Proceedings
Deeds
LIS PENDENS
Map Book
Mortgage Records

Seneca County Archives

Seneca County Tax Records

Seneca Falls Historical Society

Archive Collection 22: Seneca Falls, N.Y. Churches Collection, First Wesleyan Methodist Church Collection, Books 1-4, 7; also copy of One Hundred Years of Service for Christ in the Wesleyan Methodist Church 1844-1944. Utica, New York: n.p., 1944.

Archive Collection 28: Seneca Falls History Collection (General)

Archive Collection 32: Recreational and Performing Arts Collection

Archive Collection 37: Personal Papers Huntington
Personal Papers Johnson
Local Historical Personalities G. Woodworth
Local Historical Personalities E.C. Stanton

Pamphlet Collection

Photograph Collection

Scrapbook Collection

Scrapbooks #2, 3, 5, 21, unnumbered

Janet M. Cowing Scrapbook 30 1850-1912

"History of Seneca Falls From 1787 to 1873 From Scraps saved by Mrs. C.O. Goodyear"

Village of Seneca Falls

Board of Trustees of Village of Seneca Falls "Minute Book 1837-1855"
"Minute Book 1856-1872"

Village of Seneca Falls Tax Assessments

All of the above sources provided vital information about the Wesleyan Chapel and its subsequent building evolution. The Seneca Falls Historical Society possessed most of the available information on the chapel. The Wesleyan Methodist church records contained information on the congregation for the years 1843-1871, although data on the building itself was scarce. Photographs of the Johnson Hall, Johnson Opera House and subsequent building uses were found in the society's photograph collection. Handbills of productions offered in Johnson Hall and opera house were found in the Cowing Scrapbooks. Village and county tax records and deeds provided an outline of chapel's subsequent ownership.

ARTICLE

Stanton, Elizabeth Cady. "Susan B. Anthony," pp. 53-74. In Our Famous Women An Authorized Record of the Lives and Deeds of Distinguished American Women of Our Times. First Published 1883; Freeport, New York: Books for Libraries Press, 1975.

This article contains information about Susan B. Anthony, written by the woman who knew her well.

BOOKS

Disturnell, John, Compiler. A Gazetteer of the State of New York. Albany, New York: C. Van Benthuysen & Co., 1843.

DuBois, Ellen Carol, ed. Elizabeth Cady Stanton and Susan B. Anthony Correspondence, Writings, Speeches. New York: Schocken Books, 1981.

History of Seneca Co., New York 1786-1876. Philadelphia: Everts, Ensign & Everts, 1876; reprint ed., Ovid, New York: W.E. Morrison & Co., 1976.

[McClintock, Mary] Report of the Woman's Rights Convention, Held at Seneca Falls, N.Y., July 19th and 20th, 1848. Rochester, New York: John Dick, 1848[?]

Pegler, George. Autobiography of the Life and Times of the Rev. George Pegler. Syracuse, New York: Wesleyan Methodist Publishing House, 1879.

Stanton, Elizabeth Cady. Eighty Years and More Reminiscences 1815-1897. New York: Schocken Books, 1971.

Stanton, Elizabeth Cady; Anthony, Susan B.; and Gage, Matilda Joslyn. History of Woman Suffrage. vol. I 1848-1861. Rochester: Susan B. Anthony, 1889; reprint ed., New York: Source Book Press, 1970.

Stanton, Henry B. Random Recollections. New York: Harper & Brothers, 1887.

Stanton, Theodore and Blatch, Harriot Stanton, eds. Elizabeth Cady Stanton as Revealed in Her Letters Diary and Reminiscences. 2 vols. New York: Harper & Brothers Publishers, 1922.

Tolles, Frederick B., ed. Slavery and 'The Woman Question' Lucretia Mott's Diary of Her Visit to Great Britain to Attend the World's Anti-Slavery Convention of 1840. Supplement No. 23 to the Journal of the Friends' Historical Society Haverford, Pennsylvania: Friends' Historical Society and London: Friends' Historical Society, 1952.

Woman's Rights Conventions Seneca Falls & Rochester 1848. New York: Arno & The New York Times, 1969.

These sources provided much of the data for chapter II on the 1848 Women's Rights Convention. Many were written by attendees at the convention. The Pegler autobiography provided a few scant details of the Wesleyan Chapel in 1843. The Disturnell gazetteer provided information on Seneca Falls' appearance in 1848. The six volume History of Woman Suffrage was written by self-appointed chroniclers of the women's rights movement, who also were leaders in the struggle for women's suffrage and other campaigns. The History of Seneca Co., provided data on the Wesleyan Methodist congregation and on William and Charles Chamberlain Johnson.

DIRECTORIES

Boyd, Andrew. Boyd's Directory of Seneca Falls, Waterloo, Canandaigua and Geneva 1888-1889. Syracuse, New York: Central City Publishing House, 1888.

_____. Boyd's Directory of Seneca Falls and Waterloo 1890-1891. Syracuse, New York: Central City Publishing House, 1890.

Brigham, A. Delancey, compiler and publisher. Brigham's Geneva, Seneca Falls and Waterloo Directory and Business Advertiser For 1862 and 1863. Geneva, New York: A. DeLancey Brigham, 1862.

Child, Hamilton, compiler. Reference Business Directory of Seneca County, N.Y. 1894-'95 With Map. Seneca Falls, New York: E.M. Child, Courier Printing Company, 1894.

_____. Gazetteer and Business Directory of Seneca County, N.Y. For 1867-8. Syracuse, New York: Hamilton Child, 1867.

Combs, Charles W. and Pollard, J.D. compilers. Official Seneca Falls Village Directory For 1921-22. Seneca Falls, New York: The Journal Publishing Company, 1922?.

- Directory of Seneca Falls New York Vol. 1 1900. New York: Interstate Directory Co., 1900?
- Evans, William W. and Crofoot, Wesley W., compilers and publishers. Seneca Falls and Waterloo Village Directory 1874-5. Syracuse, New York: Truair, Smith & Co., Printers, 1874.
- The Journal Publishing Company, compilers. Official Seneca Falls Village Directory For 1914-15. Seneca Falls, New York: The Journal Publishing Company, 1915?
- Kellogg, R.W., compiler. Kellogg's Seneca Falls Village Directory For 1910-11. [no further publishing history]
- Lant Bros. Directory Publishers, compilers and publishers. Seneca County Directory 1881-2. Rochester: Erastus Darrow, Publisher, 1881.
- Manning, H.A. Co., compilers and publishers. Seneca Falls and Waterloo (New York) Directory for the Year Beginning January, 1927 vol. I. Schenectady, New York: H.A. Manning Co., 1927.
- _____. Manning's Seneca Falls and Waterloo (New York) Directory For Year Beginning May, 1929 vol. II. Schenectady, New York: H.A. Manning Company, 1929.
- _____. Manning's Seneca Falls and Waterloo (New York) Directory For Year Beginning August, 1935 vol. III. (Schenectady, New York: H.A. Manning Company, 1935.
- The Ned Trick Seneca Falls and Waterloo New York Directory 1954-1955 vol. I no. 5. Tupper Lake, New York: Ned Trick Directory Service, 1954.
- Parsons, Samuel, compiler. Parsons' Seneca Falls and Waterloo Directory 1888. Syracuse, New York: The Syracuse Journal Company, ca. 1888.
- Reiser, Charles J., compiler. Seneca Falls and Waterloo Directory 1902-3. Corning, New York: Press of The Robertson-Trotter Co., ca. 1902.
- Seneca Falls Directory 1939 [no further publishing history]
- Seneca Falls Including Waterloo New York ConSurvey City Directory vol. 4 1961. n.p.: Mullin-Kille and The Seneca County Press, 1961.
- Seneca Falls (Including Waterloo) New York ConSurvey City Directory vol. 5 1964. n.p.: Mullin-Kille and The Seneca County Press and News, 1964.
- _____. vol. 6 1966. n.p.: Mullin-Kille & The Seneca County Press, 1966.

Seneca Falls New York Classified Buyers' Guide 1947. n.p.: The Mullin-Kille and Press, 1947.

Seneca Falls New York ConSurvey Directory vol. 1 1942. Seneca Falls, New York: Mullin-Kille Company and The Seneca County Press, 1942.

Seneca Falls New York ConSurvey City Directory vol. 3 1958. n.p.: Mullin-Kille and The Seneca County Press, 1958.

Vick Publishing Company, compiler and publisher. Vick's Standard Directory and Reference Book of Seneca Falls and Waterloo 1906-1907. Rochester, New York: Vick Publishing Company, 1906.

These directories were most helpful in piecing together the Wesleyan Chapel's building evolution. Data on possible tenants was provided, as well as personal information on the various chapel owners and companies doing repairs on the building.

ENCYCLOPEDIAS

Dictionary of American Biography, 1962 ed., S.v. "Mott, Lucretia Coffin," by Mary Wilhelmine Williams.

_____, 1964 ed., S.v. "Stanton, Elizabeth Cady." by Mary Wilhelmine Williams.

Encyclopedia of World Methodism, "The Wesleyan Church."

Famous American Women, 1980 ed., S.v. "Mott, Lucretia Coffin."

_____, 1980 ed., S.v. "Stanton, Elizabeth Cady."

Notable American Women A Biographical Dictionary, 1971 ed. S.v. "Wright, Martha Coffin Pelham," by Paul Messbarger.

These dictionary entries provided biographical information on several 1848 Women's Rights Convention organizers, and on Wesleyan Methodist church hierarchy.

INTERVIEWS

Huntington, Emily Knight. Seneca Falls, New York, Telephone Interview, March 20, 1986.

Ludovico, Frank J. Las Vegas, Nevada, Telephone Interview, April 7, 1986.

Riggs, Edwin Jr. Auburn, New York, Telephone Interview, April 8, 1986.

MAPS

Sanborn, 1881, 1886, 1897, 1911, 1925, 1925 with 1955 corrections

Seneca Falls, 1836, 1856, 1871, 1873, 1896

The Sanborn maps provided details of the Johnson Hall and opera house construction. The Seneca Falls maps provided the barest data on the building's evolution, but were useful in locating other structures in town.

NEWSPAPERS

American Reveille 1855-1857, 1859-1860

American Wesleyan 1869, 1870

Evening Herald 1894

Masonic Daily News 1902

North Star 1848

Ovid Bee 1863

Seneca County Courier 1848, 1851-1852, 1859, 1861-1862, 1864-1866,
1873-1879, 1881-1883, 1885, 1890-1892

Seneca County Courier-Journal 1906-1907, 1912, 1923, 1931-1932, 1934

Seneca County Journal 1886, 1888, 1890, 1892-1893, 1901

Seneca Falls Democrat 1843

Seneca Falls Free Soil Union 1849

Seneca Falls Reveille 1860, 1862-1873, 1875, 1880, 1890, 1893, 1895,
1906-1908, 1915-1920, 1921-1923, 1926-1928, 1948, 1961, 1964

True Wesleyan 1843, 1845, 1849

All of these newspapers yielded information on events which occurred in the Wesleyan Chapel, Johnson Hall, Johnson Opera Hall, Regent Theatre and other uses of the building. Supporting data on possible tenants was sometimes provided, along with general commentary on the building's changes in ownership and physical appearance. Political commentary on the Wesleyan Chapel congregation was gleaned from the newspapers, as well as a few details of the chapel's appearance at the time of its dedication.

PAMPHLET

Stowell, Henry. "A History of Seneca Falls, N.Y. (1779-1862)"
Originally from Brigham's - 1862 - Geneva, Seneca Falls and Waterloo Directory. Pamphlet, Seneca Falls, New York: Seneca Falls Historical Society reprint ed., April 1975.

The Stowell history provided data on the chapel congregation.

SECONDARY SOURCES
PUBLISHED ARTICLES

- Bradley, A. Day. "Progressive Friends in Michigan and New York." Quaker History 52 (Autumn 1963):95-103.
- Bullard, Laura Curtis. "Elizabeth Cady Stanton." In Our Famous Women An Authorized Record of the Lives and Deeds of Distinguished American Women Of Our Times, pp. 602-623. First published 1883; reprint ed., Freeport, New York: Books for Libraries Press, 1975.
- Clemmer, Mary. "Lucretia Mott." In Our Famous Women An Authorized Record of the Lives and Deeds of Distinguished American Women of Our Times, pp. 462-497. First Published 1883; reprint ed., Freeport, New York: Books for Libraries Press, 1975.
- Maynard, Douglas H. "The World's Anti-Slavery Convention of 1840" Mississippi Valley Historical Review 47 (1960): 452-471.
- Riegel, Robert E., ed. "'Woman's Rights and Other' Reforms' in Seneca Falls:" A Contemporary View." New York History 46 (January 1965): 41-59.
- Smith-Rosenberg, Carroll. "Beauty, the Beast and the Militant Woman: A Case Study in Sex Roles and Social Stress in Jacksonian America." American Quarterly 23 (1971): 562-584.
- _____. "The Female World of Love and Ritual: Relations Between Women in Nineteenth-Century America." Signs: Journal of Women in Culture and Society 1 no. 1 (1975): 1-29.
- Thomas, Allen C. "Congregational or Progressive Friends A Forgotten Episode in Quaker History." Bulletin of Friends' Historical Society 10 (November 1920): 21-32.
- Wellman, Judith. "Women and Radical Reform in Antebellum Upstate New York: A Profile of Grassroots Female Abolitionists." In Clio Was a Woman: Studies in the History of American Women, pp. 113-127. Edited by Mabel E. Deutrich and Virginia C. Purdy. Washington, D.C.: Howard University Press, 1980.

These secondary articles provided information on a variety of topics. The Bradley, Maynard and Thomas articles offered background data on the Progressive Quakers and the 1840 World's Anti-Slavery Convention in London. The Bullard and Clemmer articles provided biographical data on two of the 1848 Women's Rights Convention organizers. Smith-Rosenberg offered excellent analysis of the era in which the 1848 Women's Rights Convention occurred, which helped place the convention in context. The Wellman article also offered background information on the efforts of abolitionists. Riegel's editing of the Mary Bull piece provided a reminiscence of the 1848 Women's Rights Convention by an attendee.

BOOKS

- Altschuler, Glenn C., and Saltzgeber, Jan M., Revivalism, Social Conscience and Community in the Burned-Over District The Trial of Rhoda Bement. Ithaca: Cornell University Press, 1983.
- Anthony, Katharine. Susan B. Anthony Her Personal History and Her Era. New York: Russell & Russell, 1975.
- Bacon, Margaret Hope. Valiant Friend The Life of Lucretia Mott. New York: Walker and Company, 1980.
- Banner, Lois W. Elizabeth Cady Stanton A Radical for Woman's Rights. Boston: Little, Brown and Company, 1980.
- Basch, Norma. In the Eyes of the Law Women, Marriage, and Property in Nineteenth-Century New York. Ithaca: Cornell University Press, 1982.
- Beard, Mary R. Woman as Force in History A Study in Traditions and Realities. New York: Octagon Books, 1976.
- Becker, John E. A History of the Village of Waterloo New York and Thesaurus of Related Facts. Waterloo, New York: Waterloo Library and Historical Society, 1949.
- Cromwell, Otella. Lucretia Mott. Cambridge: Harvard University Press, 1958.
- Cross, Whitney R. The Burned-Over District The Social and Intellectual History of Enthusiastic Religion in Western New York 1800-1850. New York: Harper & Row, Publishers, 1950.
- Douglas, Ann. The Feminization of American Culture. New York: Alfred A. Knopf, 1977.
- Drummond, Andrew Landale. The Church Architecture of Protestantism An Historical and Constructive Study. Edinburgh: T & T Clark, 1934.
- DuBois, Ellen Carol. Feminism and Suffrage The Emergence of an Independent Women's Movement in America. Ithaca: Cornell University Press, 1978.
- Flexner, Eleanor. Century of Struggle The Woman's Rights Movements in the United States. Cambridge, Massachusetts: Harvard University Press, 1959.
- Foner, Philip S., ed. Frederick Douglass on Women's Rights. Westport, Connecticut: Greenwood Press, 1976.

- Griffith, Elizabeth. In Her Own Right The Life of Elizabeth Cady Stanton. New York: Oxford University Press, 1984.
- Gurko, Miriam. The Ladies of Seneca Falls The Birth of the Woman's Rights Movement. New York: Schocken Books, 1974.
- Hallowell, Anna Davis, ed. James and Lucretia Mott Life and Letters. Boston: Houghton, Mifflin and Company, 1884.
- Harper, Ida Husted. Life and Work of Susan B. Anthony. 3 vols. New York: Arno & The New York Times, 1969.
- Hewitt, Nancy A. Women's Activism and Social Change Rochester, New York 1822-1872. Ithaca: Cornell University Press, 1984.
- Kraditor, Aileen S., ed. Up From the Pedestal Selected Writings in the History of American Feminism. Chicago: Quadrangle Books, Inc., 1968.
- Lerner, Gerda. The Majority Finds Its Past Placing Women in History. New York: Oxford University Press, 1979.
- Lutz, Alma. Created Equal A Biography of Elizabeth Cady Stanton. New York: The John Day Company, 1940.
- McLeister, Ira Ford. History of the Wesleyan Methodist Church of America. Revised edition by Roy Stephen Nicholson. Marion, Indiana: The Wesley Press, 1959.
- Manual of the Churches of Seneca County With Sketches of Their Pastors 1895-1896. Seneca Falls, New York: Courier Printing Company, 1896.
- Melder, Keith E. Beginnings of Sisterhood The American Woman's Rights Movement, 1800-1850. New York: Schocken Books, 1977.
- Nies, Judith. Seven Women Portraits From the American Radical Tradition. New York: The Viking Press, 1977.
- Paulson, Ross Evans. Women's Suffrage and Prohibition: A Comparative Study of Equality and Social Control. Glenview, Illinois: Scott, Foresman and Company, 1973.
- Portrait and Biographical Record of Seneca and Schuyler Counties New York. New York: Chapman Publishing Co., 1895.
- Scott, Anne Firor and Scott, Andrew M. One Half the People The Fight for Woman Suffrage. Philadelphia: J.B. Lippincott Company, 1975.
- Sinclair, Andrew. The Better Half The Emancipation of the American Woman. New York: Harper & Row, Publishers, 1965.

Thomas, Hilah F., and Keller, Rosemary Skinner, eds. Women in New Worlds Historical Perspectives on the Wesleyan Tradition. Nashville: Abingdon, 1981.

Welch, Edgar L. "Grip's" Historical Souvenir of Seneca Falls. Syracuse?, New York: n.p., 1904.

Watrous, Hilda. The County Between the Lakes A Public History of Seneca County, New York 1876-1982. Waterloo, New York: Seneca County Board of Supervisors, 1982.

Many of these secondary works provided background data on the women's rights movement as it evolved after the 1848 Women's Rights Convention. Chronicling the movement, headed by Elizabeth Cady Stanton, Susan B. Anthony, and their co-workers were the texts by Anthony, Bacon, Banner, Basch, Beard, Cromwell, Douglas, Flexnor, Gurko, Hallowell, Harper, Hewitt, Kraditor, Lerner, Lutz, Melder, Nies, Paulson, Scott, and Sinclair. The Thomas and Keller book provided scarce data on the history of women within the Methodist tradition, although no information specific to Seneca Falls was found. The Watrous book provided much needed information concerning the chapel building during the twentieth century, as the focus of commemoration by the National Woman's Party and other groups. Data on the Wesleyan Methodist congregation in Seneca Falls was found in McLeister, Manual of Churches, Welch and One Hundred Years. Cross, and Altschuler and Saltzgaber provided a religious and geographical context for the 1848 Women's Rights Convention by examining the environments existing prior to, or at the time of, the convention. The Drummond text provided general data on Protestant architecture in Great Britain.

MISCELLANEOUS CORRESPONDENCE

Thomas, Paul W., Archives and Historical Library, The Wesleyan Church, Marion, Indiana, April 8, 1986.

Wellman, Judith, Ph.D., State University of New York, Oswego, New York, April 4, 1986.

PAMPHLET

"A History of The Wesleyan Church," Marion Indiana: Office of the General Secretary, The Wesleyan Church, November 1982.

REPORTS

Building-Structure Inventory Form, NYS Office of Parks, Recreation & Historic Preservation, Division For Historic Preservation, "Charles Corwin House, 7 Mynderse St." prepared by Rick Bernstein and Margaret McFadden, August 1985.

U.S. Department of the Interior, National Park Service, "Architectural Survey, Women's Rights National Historical Park, Seneca Falls, New York," prepared by Barbara E. Pearson, North Atlantic Historic Preservation Center, Boston, Massachusetts, March 1984.

U.S. Department of the Interior, National Park Service, "Special History Study, Women's Rights National Historical Park, New York," prepared by Sandra S. Weber, Denver Service Center, Denver, Colorado, 1985.

The inventory form provided information on Charles C. Corwin, the owner of the chapel after it was sold by the Wesleyan Methodists. The Pearson report offered data on the building's physical history, while the Weber study contained information on Seneca Falls history, Wesleyan Methodist congregational history, and data on the 1848 Women's Rights Convention and its organizers.

UNPUBLISHED PAPERS

"Albert Jewett." In Papers read before the Seneca Falls Historical Society Including the History and Centennial Proceedings of the First Presbyterian Church, Seneca Falls, N.Y. for the year 1907, pp. 37-40. (Seneca Falls Historical Society Papers, 1903-1911/12.)

Cowing, Mrs. Philo and Frazier, Rev. S.F. "Early Churches of Junius." In 100th Anniversary of the Town of Junius. Historical Papers Read before the Seneca Falls Historical Society, pp. 27-34. (Seneca Falls Historical Society Papers, 1903-1911/12.)

Medden, Edwin. "The First Congregational Church." In Centennial Anniversary of Seneca County and Auxiliary Papers published by the Seneca Falls Historical Society, 2d Annual, 1904, pp. 65-66. (Seneca Falls Historical Society Papers, 1904-1911/12.)

Monroe, Stephen, "Seneca Falls in Earlier Days. 'Should Old Acquaintance be Forgotten.'" In Papers read before the Seneca Falls Historical Society For the Years 1911-12, pp. 33-45. (Seneca Falls Historical Society Papers, 1904-1911/12.)

Sanderson, James S., "Some Early Recollections of Seneca Falls." In Papers read before the Seneca Falls Historical Society For the Years 1911-12, pp. 58-60. (Seneca Falls Historical Society Papers 1904-1911/12.)

Teller, Fred. "Union Hall, Daniels Hall, Daniels Opera House and Other Amusement Halls of Seneca Falls," In Papers read before the Seneca Falls Historical Society for the Year 1905, pp. 35-64. (Seneca Falls Historical Society Papers, 1904-1911/12.)

"Proceedings of the Sixtieth Anniversary of the Woman's Rights Convention Held in Seneca Falls in July, 1848." In Papers read before the Seneca Falls Historical Society for the Year 1908, pp. 26-73. (Seneca Falls Historical Society Papers, 1904-1911/12.)

Wellman, Judith. "The Mystery of the Seneca Falls Women's Rights Convention: Who Came and Why?" May 31, 1985. (Typescript. Copy available at WOR1.)

----- . "Women's Rights, Free Soil, and Quakerism: The Seneca Falls Women's Rights Convention." Paper presented at SHEAR Conference, July 1981. (Typescript. Copy available at WOR1.)

All of the Seneca Falls Historical Society papers provided data on the history of Seneca Falls, and specific information on the chapel building itself. This data was concerned with both physical appearance of the chapel building and events that occurred within its walls. The Wellman papers contained a wealth of data on the signers of the Declaration of Sentiments; the religious, economic, and social networks existing among the signers; and data on Elizabeth Cady Stanton.



As the nation's principal conservation agency, the Department of the Interior has basic responsibilities to protect and conserve our land and water, energy and minerals, fish and wildlife, parks and recreation areas, and to ensure the wise use of all these resources. The department also has major responsibility for American Indian reservation communities and for people who live in island territories under U.S. administration.

Publication services were provided by the graphics staff of the Denver Service Center. NPS D-4, April 1987

