

THE STANTON HOUSE

Women's Rights National Historical Park



99-0057-B

Historic Structure Report



THE STANTON HOUSE
HISTORIC STRUCTURE REPORT

Women's Rights National Historical Park
Seneca Falls, New York

By

Barbara A. (Pearson) Yocum
Building Conservation Branch, Northeast Cultural Resources Center
Northeast Region, National Park Service
U.S. Department of the Interior
Lowell, Massachusetts

Written 1989

Published 1998



Digitized by the Internet Archive
in 2012 with funding from
LYRASIS Members and Sloan Foundation

<http://archive.org/details/historicstructur00stant>

CONTENTS

LIST OF FIGURES AND CREDITS	viii
PREFACE	xii
ACKNOWLEDGEMENTS	xiii
EDITOR'S FOREWORD <i>May 1998</i>	xiv
I. <u>ADMINISTRATIVE DATA</u>	1
II. <u>HISTORICAL BACKGROUND</u>	5
INTRODUCTION	7
PRE-STANTON PERIOD (1798-1847)	8
Lot No. 6 and The Bayard Company	8
Development of Lot No. 6	9
Village of Seneca Falls	11
Sale of the Lower Red Mills	11
Samuel and William Bayard	12
Map of 1836	13
Bayard Domiciles	13
Sale of the William Bayard House	14
STANTON PERIOD (1847-1862)	16
Move to Seneca Falls	16
Stanton Family	17
Stanton Home	18
Exterior Appearance	19
Interior Rooms	19
Ventilation	20
Heating	21
Lighting	21
Water	21
Outbuildings	22
Grounds	22
Street Address	23

POST-STANTON PERIOD (1862-1982)	24
Sale of the Stanton House, 1862	24
Subdivision of the Stanton Lot, 1864	24
Boardman Family Ownership, 1867-1900	25
Seneca Falls Maps: 1871, 1873, and 1896	25
Photograph, Circa 1900	26
Gilmore Family Ownership, 1900-1943	27
Burroughs Family Ownership, 1945-1978	30
Ralph Peters and the Stanton House, 1978-1982	30
III. <u>PHYSICAL INVESTIGATION AND ANALYSIS</u>	45
ARCHITECTURAL INVESTIGATIONS	47
Background	47
Methodology	47
Documentation	47
Historic Building Materials	48
Nails	50
Mortar	50
Paint	50
Wallpaper	51
Circa-1900 Photograph	51
ARCHEOLOGICAL INVESTIGATIONS	53
Background	53
Investigation of the East Wing - 1980	53
Investigation of the Wings and Porches - 1983	53
Investigation of Cellar Features - 1983	56
IV. <u>DESCRIPTION OF PHYSICAL EVOLUTION</u>	59
INTRODUCTION	61
PRE-STANTON PERIOD (1798-1847)	62
Background	62
Early Buildings	62
Origin of the South Wing	63
Origin of the Main House	63

Moving and Reconstruction, Circa 1837	65
The East Wing	69
The North Wing	70
Later Interior Decorating	71
Remodeling, Circa 1840	71
Redecorating, Circa 1841-1846	74
STANTON PERIOD (1847-1862)	75
Background	75
Exterior Appearance	75
Site	75
General Description	75
Walls	76
Doorways	76
Windows	77
Roofs, Cornices, and Gutters	78
Chimneys	79
Finishes	79
Interior Appearance	80
Finishes	80
Kitchen Location	80
Cellar	81
Room 101	83
Room 102	87
Room 103	91
Room 104	96
Room 201	101
Room 202	105
Room 203	108
Room 204	112
POST-STANTON PERIOD (1862-1982)	116
Background	116
Removal of the North Wing, Circa 1864	116
First-Story Alterations, Circa 1880	117
Remodeling, 1902-03	117
Shed Addition and Electrical Wiring, Circa 1910	118
New Shop, 1919	119
Exterior Painting, 1928	119
Exterior Shingle Siding, Circa 1930s	119
Renovations, 1948	120
More Renovations, 1960s-1970s	120

V. <u>EXISTING CONDITIONS AND RECOMMENDATIONS</u>	131
EXISTING CONDITIONS	133
Background	133
Exterior Conditions	135
Interior Conditions: Cellar	147
Interior Conditions: First Story	151
Interior Conditions: Second Story	173
RECOMMENDATIONS	189
Background	189
Site	190
Structural Work	190
Exterior Features	191
Foundation	191
Siding	191
Doorways	192
Windows	193
Roofs	195
Cornice and Gutters	196
Chimneys	196
Missing Wings	196
Interior Features	198
Cellar	198
Room 101	199
Room 102	202
Room 103	205
Room 104	208
Room 201	212
Room 202	215
Room 203	217
Room 204	220
Utility Systems	223

VI. <u>APPENDICES</u>	225
APPENDIX A. Nail Analysis	227
APPENDIX B. Mortar Analysis	243
APPENDIX C. Paint Analysis	257
APPENDIX D. Wallpaper Analysis	281
APPENDIX E. Contents of Wall Cavities	291
APPENDIX F. Reused Woodwork	297
APPENDIX G. "Home Life" Lyceum Speech, Circa 1880	333
APPENDIX H. Site Drawings of Existing Conditions, 1982-1983	337
VII. <u>BIBLIOGRAPHY</u>	385

LIST OF FIGURES AND CREDITS

1.	“Map of the Village of Seneca Falls for V.B. Ryerson” (detail) by John Burton, 1836. Courtesy the Seneca Falls Historical Society	31
2.	Map of the Village of Seneca Falls, 1852, from the <i>Plat Book of Topographical Maps; Seneca County, New York</i> . Courtesy the Seneca Falls Historical Society	32
3.	Cadastral wall map (detail) by J.H. French, 1856. Courtesy the Seneca Falls Historical Society	33
4.	Subdivision of the Stanton lot, as suggested by the tax assessment of 1864. NPS drawing by Barbara Yocum	34
5.	“Map of the Village of Seneca Falls” (detail) by W.W. Richie, Philadelphia, 1871. Courtesy the Seneca Falls Historical Society	35
6.	“Bird’s Eye View of Seneca Falls, N.Y., 1873” (detail) by Parsons and Atwater. Courtesy the Seneca Falls Historical Society	36
7.	Map of Seneca Falls, 1896. Courtesy the Seneca Falls Historical Society	37
8.	Earliest exterior photograph of the Stanton House, circa 1900. Courtesy the Seneca Falls Historical Society	38
9.	Stanton House: west elevation, photograph dated circa 1904-05. Courtesy the Seneca Falls Historical Society	39
10.	Stanton House: west and south elevations, post card dated circa 1915. Courtesy the Seneca Falls Historical Society	40
11.	Insurance map “Seneca Falls, New York,” by the Sanborn Map Company, 1925 corrected to 1955. Courtesy the Seneca Falls Historical Society	41
12.	Stanton House: west elevation, photograph dated circa 1920s. Courtesy the Seneca Falls Historical Society	42
13.	Stanton House: west elevation, photograph dated circa 1930s. Courtesy the Seneca Falls Historical Society	43
14.	Stanton House: west and east elevations, photographs by J. Carl Burke, Jr., for the Historic American Buildings Survey, July 19, 1968	44
15.	Map showing areas of archeological testing at the Stanton House, May 1983. NPS drawing by Linda Towle	57

Note: The next nine figures are NPS conjectural drawings prepared by Jana Gross in 1989.

16.	First-floor plan of William Bayard's house, circa 1837	122
17.	Second-floor plan of William Bayard's house, circa 1837	123
18.	Stanton House: west elevation, circa 1847-62	124
19.	Stanton House: south elevation, circa 1847-62	125
20.	Stanton House: east elevation, circa 1847-62	126
21.	Stanton House: north elevation, circa 1847-62	127
22.	Stanton House: cellar plan, circa 1847-62	128
23.	Stanton House: first-floor plan, circa 1847-62	129
24.	Stanton House: second-floor plan, circa 1847-62	130
25.	Stanton House: west elevation. Measured drawing by Paul D. Dolinsky and Rebecca Trumbull for the Historic American Buildings Survey, 1982	137
26.	Stanton House: west elevation. NPS annotated photograph by Barbara Yocum, June 1982	138
27.	Stanton House: front porch interior. NPS annotated photograph by Barbara Yocum, June 1982	139
28.	Stanton House: south elevation. Measured drawing by Paul D. Dolinsky and Rebecca Trumbull for the Historic American Buildings Survey, 1982	140
29.	Stanton House: east elevation. Measured drawing by Paul D. Dolinsky and Rebecca Trumbull for the Historic American Buildings Survey, 1982	141
30.	Stanton House: south and east elevations. NPS annotated photograph by Barbara Yocum, June 1982	142
31.	Stanton House: east elevation. NPS annotated photograph by Barbara Yocum, June 1982	143
32.	Stanton House: north and east elevations. NPS annotated photograph by Barbara Yocum, June 1982	144
33.	Stanton House: roof and site plan. Measured drawing by the Historic American Buildings Survey, 1982	145

34.	Stanton House: basement [cellar] plan. Measured drawing by Paul D. Dolinsky for the Historic American Buildings Survey, 1982	149
35.	Stanton House: first-floor plan. Measured drawing by Paul D. Dolinsky for the Historic American Buildings Survey, 1982	153

Note: except as noted, all of the following figures are NPS annotated photographs by Barbara Yocum, 1982.

36.	Stanton House: Room 101, looking south	154
37.	Stanton House: Room 101, looking west	155
38.	Stanton House: Room 101, looking north	156
39.	Stanton House: Room 101, looking east	157
40.	Stanton House: Room 101, detail of east wall at former mantel location	158
41.	Stanton House: Room 101, looking southeast	159
42.	Stanton House: Room 101, looking northwest	160
43.	Stanton House: Room 102, looking east	161
44.	Stanton House: Room 102, looking southwest	162
45.	Stanton House: Room 103, looking west	163
46.	Stanton House: Room 103, looking north	164
47.	Stanton House: Room 103, looking southwest	165
48.	Stanton House: Room 103, looking southeast	166
49.	Stanton House: Room 104, looking southwest	167
50.	Stanton House: Room 104, looking north	168
51.	Stanton House: Room 105, looking northeast	169
52.	Stanton House: Room 105, looking northwest	170
53.	Stanton House: Room 105, looking southwest	171
54.	Stanton House: Stairway to the second story	172

55.	Stanton House: second-floor plan. Measured drawing by Paul D. Dolinsky and Rebecca Turnbull for the Historic American Buildings Survey, 1982	175
56.	Stanton House: second-story hall, looking southwest	176
57.	Stanton House: second-story hall, looking north	177
58.	Stanton House: second-story hall, detail of braced-frame post at north wall	178
59.	Stanton House: second-story hall, looking south	179
60.	Stanton House: Room 201, looking northeast	180
61.	Stanton House: Room 201, looking northwest	181
62.	Stanton House: Room 202, looking north	182
63.	Stanton House: Room 202, looking southeast	183
64.	Stanton House: Room 202, looking southwest	184
65.	Stanton House: Room 203, looking east	185
66.	Stanton House: Room 204, looking southwest	186
67.	Stanton House: Room 204, looking northeast	187

Also see Appendix H for annotated site drawings of the Stanton House.

PREFACE

This historic structure report is the product of an exhaustive documentary, architectural, and archeological investigation of the Stanton House. Research on the site commenced in 1980 when Dr. Paul Grebinger of Eisenhower College conducted an archeological dig of the missing east wing. A report on the findings of the dig was entitled "The Domestic Economy of Elizabeth Cady Stanton: Her House and Its Artifacts." Shortly thereafter, a report on the history of the house was written by Corinne Guntzel for the National Park Service. This report was entitled "History of the Stanton House" and dated June 1, 1982.

National Park Service research commenced in June 1982. The first step was to record the existing conditions with black-and-white photographs and detailed site drawings. Architectural drawings were prepared by the Historic American Buildings Survey. A search was also begun at this time for early photographs and other historical documentation on the site. This search focused on sources most likely to produce specific information about the building; these sources are listed in the bibliography.

Architectural investigation of the house began in July 1982. Assisting in this work was a National Park Service restoration crew under the supervision of Exhibit Specialist John T. Darcy. It was found that the Stanton House had been extensively remodeled in 1902-03, during which many pieces of the old building had been reused in new locations. Historic doorway architraves, for example, were found to have been reused as wall studs, and pieces of an old mantel as floor joists. Reconstruction of the historic appearance of the house therefore involved removing the later alterations, carefully studying the pieces, and reassembling the historic assemblage. In many ways, this work resembled a jigsaw puzzle. Additional archeological work was undertaken on the site and in the basement in 1983.

The information thus compiled will enable the National Park Service to accurately restore the house to the period 1847-62. The conclusions drawn here were based on the best and most complete evidence available at the time the report was written. However, it is possible that additional evidence may come to light in the future, particularly documentary information. Such information may contradict—or confirm—some of these conclusions.

ACKNOWLEDGEMENTS

Many people deserve recognition for their involvement with the Stanton House. Ralph Peters purchased the house in 1978 and thereby assured its preservation. The Elizabeth Cady Stanton Foundation dedicated itself to saving the house and supported the involvement of the National Park Service (NPS); three members who should be remembered for their contributions are the late Corinne Guntzel, Judy Wellman, and Lucille M. Povero. Judy Hart of the National Park Service was instrumental in the creation of Women's Rights National Historical Park, and later became its first superintendent. The staff at the Seneca Falls Historical Society was most cooperative in allowing the use of their extraordinary collection of local maps, photographs, and written documentation. Research on the architectural materials of the Stanton House could not have been accomplished without the National Park Service restoration crew supervised by Exhibit Specialist Darcy and later, Stephen S. Spaulding. Archeological investigations at the site were supervised by Dr. Paul Grebinger of Eisenhower College, and by Linda Towle (assisted by Dick Hsu) of the National Park Service. Several staff members at the North Atlantic Historic Preservation Center should be remembered for their work at the Stanton House. These were E. Blaine Cliver, Chief, Historic Preservation; Peggy Albee, Architectural Conservator; and, Larry Sorli, Historical Architect. It was Cliver's expertise with historic buildings that caused many pieces of the Stanton House puzzle to fall into place. Albee worked on the historic appearance of the exterior cornices, the front doorway, and the mantels. Sorli worked out the design of the historic stairway, the doors, and other missing features of the house. Also, Edward McManus, NPS Metals Conservator, reconstructed the historic design of the Merriman-type window sash springs. Finally, thanks goes to Architectural Technician Jana Gross, whose illustrations appear in this report.

EDITOR'S FOREWORD

May 1998

A complete NPS exterior and interior restoration of the extant portions of the Stanton House was accomplished in 1983-85 by the North Atlantic Historic Preservation Center (NAHPC), North Atlantic Region (NAR), located in Boston, Massachusetts. The work was guided by the findings and recommendations contained in this report. The missing wings were not reconstructed. For more information, see the forthcoming completion report on the project.

Since the restoration, Women's Rights National Historical Park (NHP) has been able to acquire four adjacent properties that were historically part of the Stanton House lot, but were later sold off. These are the Nies House, the Dewall Ranger Station, the parking lot, and the former Hawker House. Thus, the park now holds the entire area of the historic Stanton House lot.

Administrative changes since 1982 include the inclusion of the former North Atlantic Region (NAR) of the National Park Service into the Northeast Region (NER), headquartered in Philadelphia. The North Atlantic Historic Preservation Center (NAHPC) has become the Building Conservation Branch (BCB) of the Northeast Cultural Resources Center (NCRC), located in Lowell, Massachusetts.

I. ADMINISTRATIVE DATA

The Stanton House is located at 32 Washington Street in Seneca Falls, New York. It is significant for being the former home of Elizabeth Cady Stanton who lived here with her family from 1847 until 1862. Elizabeth Cady Stanton was one of the organizers and participants in the first Women's Rights Convention that took place at the Wesleyan Chapel in Seneca Falls in July 1848. She is also remembered for being the philosophical force and the rhetorician of the 19th-century women's rights movement.

State recognition of the Stanton House was bestowed in 1932 when a historical marker was installed on the front lawn by the New York State Education Department. National recognition was conferred in October 1966 when the house was entered as a National Historic Landmark in the National Register of Historic Places. The house was also listed as part of a thematic nomination to the National Register—"The Women's Historic District"—in February 1980. Women's Rights National Historical Park was established by Public Law 96-607 Title XVI, which was signed on December 28, 1980. Section 1601(c) of that document designated the Stanton House, then in private ownership, as one of nine sites in the new park. The house was purchased by the U.S. Government for inclusion in the park in June 1982. Women's Rights National Historical Park was officially dedicated the following month, in July 1982. That summer, the Stanton House was surveyed by Cornell University for inclusion in the New York State Building-Structure Inventory. Architectural drawings of the existing condition of the house also were prepared by the Historic American Buildings Survey in the summer of 1982.

Treatment of the Stanton House had been discussed several years earlier in a report dated October 1979 and entitled "Women's Rights Historic Sites: Study of Alternatives." This report noted that several alterations had been made over the years to both the house and to the site. It further recognized that, "despite these alterations, there appears to be sufficient evidence to restore the house to its appearance during the years it was occupied by the Stantons." Alternative two of the report proposed a restoration of the house. It states:

The life of Elizabeth Cady Stanton and her role in the women's rights movement would be interpreted at the Stanton house, which would be restored to the extent feasible....An important aspect of the events leading up to the 1848 convention was Stanton's boredom and discontent with her life in Seneca Falls after a much more intellectually stimulating life in Boston. This story and her later role in the women's rights movement could be graphically portrayed at the restored Stanton house.

Work commenced in July 1982 to determine the feasibility of restoring the Stanton House to the period of Stanton occupancy, 1847-62. Section-106 approval was given "to research the structure for potential period fabric and any architectural detail evidence that may remain. This work will entail removal of nonhistoric fabric from a historic structure." The findings of the investigation were written in a "Preliminary Historic Structure Report" dated October 1982. This report stated that sufficient historical documentation and physical evidence existed to perform an accurate restoration of the existing main house and the south wing; insufficient evidence remained to reconstruct the missing east and north wings.

Meetings were then held to discuss these findings with the cultural resource professionals in the National Park Service's North Atlantic Regional Office. It was agreed that a restoration would have "no adverse effect on the qualities for which the building was included in the National

Register.” The National Park Service further believed that, “indeed, a restored Elizabeth Cady Stanton House will enable the park visitor to understand more clearly the domestic environment in which Stanton lived and formulated the ideas which led to the Seneca Falls Convention in July 1848.”¹

Finally, a meeting was held at the Stanton House on December 16, 1982, which was attended by professionals from both the National Park Service and the New York State Historic Preservation Office. Again, a concurrence of “no adverse effect” was reached. The Advisory Council on Historic Preservation in Washington, D.C., agreed with this decision as stated in a letter to the NPS Regional Director dated February 2, 1983. This concluded “Section-106” review. Restoration of the house was therefore allowed to proceed.

The Stanton House is included in the National Park Service “List of Classified Structures” as LCS number “22582,” structure number “01.” It is a “Category A” structure, meaning it “must be preserved and maintained.”

¹ Letter dated November 29, 1982, from NAR Regional Director to the New York State Historic Preservation Officer.

II. HISTORICAL BACKGROUND

INTRODUCTION

The purpose of the architectural investigation and research at the Stanton House, Women's Rights National Historical Park, was to determine the appearance of the house when Elizabeth Cady Stanton lived there from 1847 to 1862. Since very little written documentation survives about the building, the emphasis of this investigation has been to supplement the written record by studying the structure itself. Building materials can often be dated and thus serve as a primary source of information. These materials include paint, nails, lath, mortar, wallpaper, and moldings, to name a few. In addition, archeological work done in the summer of 1980 and in 1983 has provided information about those portions of the house that are no longer standing. Used in conjunction with the extant written and photographic record, it was possible to determine how the Stanton House looked in the mid-19th century.

Historical documents reviewed in 1982 included photographs, property deeds, mortgages, maps, court records, tax records, local directories, federal census records, Stanton family letters and biographies, news articles, and publications of the Seneca Falls Historical Society. The time period researched spans the years from the late 18th century (since it is not known exactly when the house was built) to the present time. In addition, an attempt was made to locate writings of or about the Bayard family, since William M. Bayard is known to have occupied the house prior to the Stantons. Organizations whose collections were consulted for this research are listed in the bibliography of this report.

PRE-STANTON PERIOD (1798-1847)

The house in Seneca Falls given by Daniel Cady to his daughter Elizabeth Cady Stanton in 1847 had by that time been standing for at least nine years.¹ It was documented as being extant in 1838, when it was owned and occupied by the family of William Bayard.² There is very little historical documentation on the house prior to the Stantons' occupancy. No pre-Stanton drawings, prints, or photographs are known to exist. Fortunately, the development of the site and the adjacent Village of Seneca Falls has been recorded in both primary and secondary sources. These sources were helpful in understanding the history of both the Stanton House and its site, which the architectural and archeological evidence indicates has been unusually complex. Briefly, the site appears to have had two early buildings on it. These were probably gone by ca. 1837, when the main house and its south wing were moved onto the site from separate locations. The east wing appears to have been constructed at about the same time. The physical evidence for these conclusions is presented in Chapter IV.

Lot No. 6 and The Bayard Company

The two acres of land on which the Stanton House stood in 1846 were originally part of Lot No. 6 in the West Cayuga Reservation.³ This lot comprised 250 acres of land and "embrac[ed] about one-half the water power on [the south] side of the [Seneca] river."⁴ In the late 18th century, Lot No. 6 was located outside the Village of Seneca in the Town of Washington, County of Cayuga.⁵ All 250 acres were purchased in 1798 by the Bayard Company.⁶

The Bayard Company was composed of five partners in 1798: Stephen N. Bayard, Robert Troup, Nicholas Gouverneur, Elkanah Watson, and Colonel Wilhelmus Mynderse.⁷ Bayard and Watson had been officers during the Revolutionary War, and first came to the area in 1791 "to spy out the land which the State had recently set apart as bounty land for soldiers."⁸ Colonel Mynderse,

¹ Different sources cite the date of the Stantons' move into the house as 1846 or 1847. The date of 1847 will be used in this report.

² Mortgage Book R, Bayard Papers, Seneca Falls Historical Society.

³ Based on deed research in the Seneca County Courthouse, Waterloo, New York.

⁴ Henry Stowell, *A History of Seneca Falls, New York (1779-1862)* (reprinted from *Brigham's 1862 directory for Geneva, Seneca Falls, and Waterloo*, by the Seneca Falls Historical Society, 1975), p. 6.

⁵ Stowell, p. 10.

⁶ Stowell, p. 6.

⁷ Stowell, p. 4.

⁸ Mrs. S.A. Wetmore, "The Bayard Family," *Seneca Falls Historical Society Papers, 1911-12*, p. 65.

who became a partner in 1795, was an active member of the company and its business agent.⁹ Of the five partners, he appears to have been the only one who resided in the area. His “double log house” was built on a hill (not on Lot No. 6) in 1795.¹⁰ Sometime before 1803, Gouverneur and Watson relinquished their interests in the company to Robert Troup. Bayard, Troup, and Mynderse were therefore the only remaining partners when the name of the company was changed from the “Bayard Company” to “W. Mynderse and Company” in 1803.¹¹

Development of Lot No. 6

Lot No. 6 was first developed in 1807 after being in the possession of the Bayard Company, later known as W. Mynderse and Company, for nearly nine years.¹² Local boundaries had changed by 1807, so the property was then within the jurisdiction of the Town of Junius, County of Seneca.¹³ This venture involved the construction by the company of a grist mill on the lower rapids of the Seneca River. Known as the Lower Red Mills, it was the second flouring mill in the area. The first was the Upper Red Mills, located to the west of the Lower Mills, and built in 1795 by the Bayard Company.¹⁴ The Lower Red Mills and surrounding land are seen in two early maps of the Village of Seneca Falls, dated 1815 and 1825.¹⁵

Not long after the construction of the Lower Red Mills, W. Mynderse and Company began to experience financial difficulties. Robert Troup withdrew from the concern in 1809 by disposing of his interests to Stephen Bayard, including a three-fifths share of Lot No. 6.¹⁶ Most or all of the company’s property was finally put up for sale in 1817, at which time a notice describing four parcels was issued.¹⁷ Parcel number one included holdings in the Seneca Falls area. “Two Grist Mills” were described as part of this parcel, leaving no doubt that Lot No. 6 was part of the sale.

⁹ Stowell, p. 4.

¹⁰ Stowell, p. 6.

¹¹ Wetmore, “The Bayard Family,” p. 66.

¹² Stowell, p. 6.

¹³ Stowell, pp. 5-6. Junius was founded in 1803 and Seneca County in 1804.

¹⁴ Stowell, p. 6.

¹⁵ The 1815 map is entitled “Plan of the Village of Seneca Falls--Laid Out for W. Mynderse & Co. by F. Geddes Esq., Aug. 26th 1815.” The 1825 map is entitled simply a “Map of the Village, Seneca Falls.” Both are in the collection of the Seneca Falls Historical Society.

¹⁶ Wetmore, “The Bayard Family,” p. 66, and Deed Book D, p. 457.

¹⁷ Stowell, pp. 7-8.

The notice gives an excellent description of the area in 1817:

No. 1 To contain about 1,160 acres, in one connected parcel on which are erected two Grist Mills, each with two Runs of Stone, with every necessary machinery for manufacturing flour of the very best quality; and ample storage for 30,000 bushels of wheat; a Saw Mill, Fulling Mill, Clothier's Work, Drying House, and three Carding Machines, all in the best order; a large Dwelling House, with proper out-houses; two very convenient dwelling houses for millers, a Cooper Shop and implements, a new store-house for mercantile purposes, and another for storage of flour and merchandise.

Of this tract a due portion is under cultivation, and the residue is well timbered; the land is of best quality, well cleared and fenced, with good barns and other buildings, calculated for the use of farmers....¹⁸

For reasons that are not known, the property advertised by W. Mynderse and Company in 1817 did not sell. Not until 1825 was the company dissolved and its holdings dispersed. At that time, "all parties met...and chose Herman Bogart & Jacob L. Lazelere as the commissioners to divide the property into...equal shares, each partner to draw by lot their respective share...."¹⁹ It was later recalled that "in the distribution of assets the bonds, mortgages, and the lower end mill with its surroundings [went] to S.N. Bayard."²⁰ The latter included a portion of Lot No. 6.

It is unclear if one or both of the early structures were standing on the Stanton House site when Stephen Bayard acquired full title to the Lower Mill property in 1825. The 1815 and 1825 maps of the Village of Seneca Falls that depict the Lower Red Mills and surrounding property show no structures in the vicinity of the mill building or on the Stanton House site. However, it is possible that insignificant and/or deteriorated buildings existed but were simply not shown. Ancillary buildings to the Lower Red Mills may have been constructed on the lot as early as 1807 or sometime thereafter by W. Mynderse and Company. The notice distributed in 1817 by the company does in fact describe "two very convenient dwelling houses for the millers,...storage buildings,...and good barns and other buildings, calculated for the use of farmers....," although no exact locations are given.²¹

¹⁸ Stowell, pp. 7-8.

¹⁹ Stowell, p. 9.

²⁰ Wetmore, "The Bayard Family," pp. 65-66.

²¹ Stowell, pp. 7-8. More precise information on these buildings could no doubt be obtained from the books and diaries of Colonel Mynderse, which were said to be "models of neatness and regularity" in 1862. These documents, however, could not be located in 1982.

Village of Seneca Falls

The Village of Seneca Falls saw considerable changes following the dissolution of W. Mynderse and Company in 1825. During the company's nearly 30-year tenure, "rival villages [had] sprung up on either side—the county buildings were located elsewhere—and a water-power capable of propelling one hundred and fifty runs of millstone...suffered to run to waste...."²² After 1825 "commenced the progress and rapid growth of Seneca Falls."²³ In 1829, the Town of Junius was subdivided and the Town of Seneca Falls created.²⁴ The Village of Seneca Falls was incorporated in 1831.²⁵ The 1830s were a boom period for the village: many new businesses and organizations were established, and a large number of buildings and homes constructed. By 1836, Seneca Falls had 450 dwelling houses and 3,000 inhabitants, compared to 40 dwellings and 200 inhabitants in 1824.²⁶

Whether or not Stephen Bayard's Lower Red Mills also prospered in the years following 1825 is not known, since no records of the business have been found. Bayard himself apparently never lived in Seneca Falls. He is recorded in the Seneca County Registry of Deeds as being "late of Schenectady, but at present of New York City" in 1809, and "of New York City" in 1831.²⁷ In his absence, Bayard may have either administered the Red Mills from afar, employed a business manager in Seneca Falls, or leased the property to someone else. It is possible that he maintained a business arrangement with Colonel Mynderse after the dissolution of their company in 1825. Colonel Mynderse remained a resident of Seneca Falls until his death in 1836.²⁸

Sale of the Lower Red Mills

The Lower Red Mills, along with other holdings in Seneca Falls, were sold at public auction in 1831 to pay a debt of \$23,353.56 owed by Stephen N. Bayard to Samuel and Richard Stockton.²⁹ The property was then described as "part of Lot No. 6 of the West Cayuga Reservation in the County of Seneca...supposed to contain about 73 acres of land excepting out of the same about 2

²² Stowell, p. 7.

²³ Stowell, p. 9.

²⁴ Stowell, p. 6.

²⁵ Stowell, p. 18.

²⁶ Stowell, "New York Gazetteer Supplements."

²⁷ Deed Book D, p. 457, and Deed Book X, p. 421.

²⁸ Stowell, p. 9.

²⁹ Deed Book X, p. 421.

acres of land owned by Wilhelmus Mynderse....”³⁰ It was purchased by Susan Bradford, Samuel Bayard, and Elias Boudinot, all of New Jersey, and executor trustees of the Elias Boudinot estate. It appears that the new owners had no intention of moving to Seneca Falls, since they were described as still residing in New Jersey two years later in 1833.³¹

Samuel and William Bayard

The Bayard family regained possession of the Lower Mills property in December 1833. At that time, the 73-acre parcel of Lot No. 6 in the West Cayuga Reservation was purchased by Samuel J. Bayard “of Seneca Falls” and William M. Bayard “of Palmyra, N.Y.”³² Both Samuel and William were sons of Stephen N. Bayard. Both were residents of the area at the time their deed was recorded in 1833. Wetmore has suggested that the brothers had come to Seneca Falls from Albany as early as 1825 “to manage their father’s share of the property.”³³ However, Federal census records (taken every 10 years) suggest that the Bayards did not live in the area until after 1830, and that they did not come from Albany. They first appear in the Federal census for Seneca County in 1840. They are not listed in the Wayne County (Town of Palmyra) Federal census for 1830, nor in the City of Albany Federal census for 1820 and 1830.³⁴ It is possible that they arrived prior to 1830 and were “missed” by the 1830 census takers: they may have been living in someone else’s home, and so were not listed as the “head of household” on the census forms. It seems more likely, though, that Samuel and William did not move to the Seneca Falls area until sometime after 1830 and before December 1833, when they purchased the 73 acres of Lot No. 6.

Samuel and William Bayard were described in an early 20th-century article as being “energetic men who soon enlarged the capacity of the lower mill to two hundred and fifty barrels of flour a day.”³⁵ However, they did not retain ownership for long because in April 1835 they sold the mill, along with 1 1/2 acres of land and water rights sufficient for four runs of mill stones, to Richard Richardson.³⁶ A map of the Village of Seneca Falls made in 1836 shows “The Richardson Mills” in the same location as the former Lower Red Mills.³⁷ Although no longer owners of the Lower Red Mills, the Bayards did not give up the milling business completely or the “Red Mills”

³⁰ Deed Book X, p. 421.

³¹ Deed Book Z, p. 150.

³² Deed Book Z, p. 150.

³³ Wetmore, “The Bayard Family,” p. 66.

³⁴ The Federal census records were viewed on microfilm at the National Archives Waltham Record Center in Waltham, Massachusetts.

³⁵ Wetmore, “The Bayard Family,” p. 66.

³⁶ Deed Book C, p. 339.

³⁷ “Map of the Village of Seneca Falls for V.B. Ryerson by John Burton, Surveyor, Drawn about Sept. 1836,” Seneca Falls Historical Society.

appellation. In a September 1836 issue of "The Seneca Farmer," Bayard and Company advertised lime and ground plaster for sale at the "Red Mill":

Customers from a distance may always be sure of a load here. Our storehouse is calculated to hold four or five hundred tons and our mill is kept running without any necessary interruption.³⁸

That the plaster mill was also located on Lot No. 6 is verified by a mortgage release of that property dated 1852 that mentions the "post and board fence next East from the Old Plaster Mill stand."³⁹

Map of 1836

As briefly mentioned in the previous section, another map was drawn of Seneca Falls in the same year that the Bayards were advertising in "The Seneca Farmer." Dated "about September 1836," the map was entitled "Map of the Village of Seneca Falls for V.B. Ryerson by John Burton." Streets are shown in the vicinity of Lot No. 6, and the land is subdivided into numbered lots. "Washington" is one of these streets, with lots on the east side numbered one through 20 (from south to north). No buildings are delineated on Lots 16 through 20, at the corner of Washington and Seneca Streets (the later site of the Stanton House).

Bayard Domiciles

It is not known where Samuel and William Bayard lived in the Seneca Falls area prior to 1836-37.⁴⁰ The first record of Samuel's residency dates to 1836-37, when he purchased the "newly built" home of Colonel Mynderse soon after the Colonel's death.⁴¹

William Bayard and his family appear to have been living in the structure now known as the Stanton House by 1838. This is based on a mortgage document dated December 1838, in which Samuel and William and their wives mortgaged their 73 acres of Lot No. 6 for \$15,000. Excluded in the mortgage were the two acres formerly owned by Colonel Mynderse, six parcels that had been sold off or contracted, and "the house and lot now occupied by Wm. M. Bayard at the corner of Washington and Seneca Str."⁴² This is the first known reference to the house occupied by the Stanton family nine years later.

³⁸ Wetmore, "The Bayard Family," p. 66.

³⁹ Deed Book D2, p. 51.

⁴⁰ Directories of Seneca Falls would provide valuable information on the Bayard's whereabouts, but none prior to 1862-63 have been located.

⁴¹ Wetmore, "The Bayard Family," p. 66.

⁴² Mortgage Book R, Bayard Papers, Seneca Falls Historical Society.

The Federal census of 1840 gives a general idea of the size and type of household headed by William M. Bayard. It is known from other sources (to be discussed later) that William Bayard still occupied the “Stanton House” at the time of the census. The total number of household members listed under the name of “William M. Bayard [sic]” is eight, including three males and five females. The oldest male, most likely William, is recorded as being “employed in the navigation of canals, lakes, & rivers.” Of the females, one is listed as being under the age of five, one between the ages of five and 10, one between the ages of 15 and 20, and two between the ages of 20 and 30. One of the latter is presumably William’s wife, Romenia.

The house occupied by this large family, as explained in Chapter IV, appears to have been created circa 1837 by moving a two-story main house onto the property from an unknown location, and attaching to it a south wing probably moved in from yet another unknown location. Two other wings were added at an early date: an east wing (on the east side of the south wing), and a north wing (on the north side of the main house). The east wing most likely dated to ca. 1837; the north wing was constructed a little later (circa 1839). The south wing was built over one of the two early foundations, while the east wing used the foundation of the other.

Sale of the William Bayard House

Financial difficulties were experienced by the Bayard brothers, according to judgments filed against them in October 1840.⁴³ In addition, payments were not made on the 1838 mortgage and a judgement describing the mortgaged property was filed on August 24, 1841.⁴⁴ Another judgement was filed in June 1842 citing Lot No. 6, “excepting...the house and lot where Bayard now lives at the corner of Washington and Seneca Streets—and other lots & c.”⁴⁵ Finally, a public auction was held on December 10, 1842, to sell all the property owned by Samuel and William Bayard as of December 4, 1840.⁴⁶ Since most of Lot No. 6 had been mortgaged to the North American Banking Company in 1838, this left of that parcel only “the house and lot now occupied by William Bayard” available for sale.

The auction of 1842 and the transactions that proceeded it are described in detail in a deed dated 1844. The sale was by decree of a ruling of the Supreme Court of New York in the law suit of William Dumont versus William M. and Samuel J. Bayard. Rights to purchase the property were sold to William A. Sacket and Robert L. Stevenson of Seneca Falls in the event that the Bayards were unable to redeem it after one year. After the passage of more than a year, the rights were purchased by William Pennington, Judgement Creditor for the Bayards. Daniel Cady (father of

⁴³ Deed Book P2, p. 225.

⁴⁴ Seneca County U.S. Pendens: 1831 to 1857, p. 15, filed August 24, 1841.

⁴⁵ Seneca County U.S. Pendens: 1831 to 1857, p. 159, filed June 21, 1842.

⁴⁶ Deed Book P2, p. 225.

Elizabeth Cady Stanton) was involved with the next transaction as representative for the Bank of Utica, and the property was finally conveyed to Elisha Foote, Jr., in March 1844.⁴⁷

Exactly when William Bayard and his family vacated their house on Washington Street is not known. They may have remained after the auction of 1842 with hopes of redeeming their property, or may have arranged in 1844 to lease from Elisha Foote, Jr. The first known reference to the Bayards' absence is Daniel Cady's deed, dated March 26, 1845, which describes the property as:

All that certain lot of land with the buildings thereon...formerly owned & occupied by William M. Bayard...bounded Sly and Ely by a board fence...and contains 2 acres of land....⁴⁸

Also on May 26 and August 20, 1845, quit-claims for the above-described property were recorded by William's wife, Romenia C., and Samuel's wife, Jane A., in exchange for \$250 and \$50 paid to them by Daniel Cady.⁴⁹ The quit-claims may represent the women's voluntary voiding of dower rights to the property sold by their husbands. No transfer of property was complete without such witnessed voiding of rights.⁵⁰

It is unlikely that the new owners of the house—Elisha Foote, Jr., and Daniel Cady—ever lived in it, given its condition in 1847 as described by Elizabeth Cady Stanton:

The house we were to occupy had been closed for some years and needed many repairs, and the grounds, comprising five [sic] acres, were overgrown with weeds.⁵¹

⁴⁷ Deed Book P2, p. 225.

⁴⁸ Deed Book 58, p. 129.

⁴⁹ Deed Book 58, p. 129.

⁵⁰ NPS memorandum, Linda Canzanelli, Superintendent, Women's Rights NHP, to Manager, Cultural Resources Center, April 2, 1992.

⁵¹ Stanton, *Eighty Years and More: Reminiscences 1815-1897* (New York: Schocken Books, 1971), p. 144. It is not known why Stanton thought she owned five acres, rather than two.

STANTON PERIOD (1847-1862)

Move to Seneca Falls

Elizabeth Cady Stanton, her husband Henry B. Stanton, and their three small sons moved to Seneca Falls from Boston because of Henry Stanton's poor health. There they lived in William Bayard's former residence, given to Mrs. Stanton by her father Daniel Cady. Exactly when this move occurred has been a point of some controversy. Mrs. Stanton wrote in her autobiography, "in the spring of 1847 we moved to Seneca Falls."⁵² Supporting this date is the deed conveying the Seneca Falls property from Daniel Cady to his daughter Elizabeth Cady Stanton, which is dated June 22, 1847.⁵³ However, in a revised autobiography entitled *Elizabeth Cady Stanton as Revealed in her Letters, Diaries and Reminiscences*, this passage was changed to read, "in 1846 we moved to Seneca Falls."⁵⁴ In addition, Mrs. Stanton recalled supervising alterations to the house at the same time that the Constitutional Convention was in session in Albany, which convened in 1846.⁵⁵ Certain issues at the convention, however, continued to be debated through 1847, so this reference cannot be used as proof that the Stantons moved in 1846.⁵⁶ To conclude, insufficient information is available to determine unequivocally if the correct date is 1846 or 1847. The date 1847 will be used in this report.

The property in Seneca Falls to which the Stantons moved is described in Elizabeth Cady Stanton's deed as follows:

...that certain dwelling House & lot of land containing about 2 acres in the Village of Seneca Falls which were formerly occupied by William M. Bayard Esquire and were conveyed by the late sheriff of the County of Seneca Falls to Elisha Foote Esquire & by him to me [Daniel Cady].⁵⁷

⁵² Stanton, *Eighty Years*, p. 143.

⁵³ Deed Book 52, p. 479.

⁵⁴ Harriot Stanton Blatch and Theodore Stanton, *Elizabeth Cady Stanton as Revealed in Her Letters, Diaries & Reminiscences*, Vol I. (New York: Harper & Brothers, 1922), p. 141.

⁵⁵ Stanton, *Eighty Years*, pp. 144-45; Corinne Guntzel, "History of the Stanton House" (typescript, Women's Rights NHP, June 1, 1982), p. 2.

⁵⁶ Sandra S. Weber, *Special History Study: Women's Rights National Historical Park* (National Park Service, September 1985), p. 63.

⁵⁷ Deed Book 52, p. 479.

Mrs. Stanton noted that the house had been "closed for some years and needed many repairs."⁵⁸ She was directly involved with the work that preceded her family's occupancy. She later wrote:

My father gave me a check and said, with a smile, "you believe in woman's capacity to do and dare; now go ahead and put your place in order." After a minute survey of the premises and due consultation with one or two sons of Adam, I set the carpenters, painters, paperhangers, and gardeners at work, built a new kitchen and wood house, and in one month took possession. Having left my children with my mother, there were no impediments to a full display of my executive ability. In the purchase of brick, timber, paint, etc., and in making bargains with workmen, I was in frequent consultation with Judge Sackett and Mr. Bascom. The latter was a member of the Constitutional Convention, then in session in Albany, and as he used to walk down whenever he was at home, to see how my work progressed, we had long talks, sitting on boxes in the midst of tools and shavings, on the status of women....⁵⁹

This account was later revised by Stanton's daughter Margaret Stanton Lawrence to read, "built a fine new kitchen, wood house, and several porches."⁶⁰

Stanton Family

Elizabeth Cady and Henry B. Stanton moved to Seneca Falls with three young sons, Daniel, Henry, and Gerrit. Four more children, two sons and two daughters, were born to them while they lived in Seneca Falls. They were named Theodore, Maggie, Hattie (Harriot), and Robert. Two Federal census records, dated 1850 and 1860, document the Stanton Family during the time they lived in upstate New York.⁶¹ These are transcribed below in their entirety.

United States Census: 1850
Seneca County, New York State

H.B. Stanton	44 M	Lawyer
E.C. "	34 F	
Daniel C. "	8 M	
H.B. "	6 M	
Gerrit "	4 M	

⁵⁸ Stanton, *Eighty Years*, p. 144.

⁵⁹ Stanton, *Eighty Years*, pp. 144-45.

⁶⁰ Margaret Stanton Lawrence, "Elizabeth Cady Stanton 1815-1915" (Vassar).

⁶¹ Federal census records, National Archives Waltham Record Center.

United States Census: 1860
Seneca County, New York State

Henry B. Stanton	54 M	Lawyer
Elizabeth C. "	44 F	
D. Cady	"	18 M
Henry	"	16 M
Gerrit S.	"	14 M
Theodore	"	9 M
Maggie	"	7 F
Hattie	"	4 F
Robt	"	1 M
Mary Leary	18 F	Servant

Stanton Home

It is unfortunate that no photographs, drawings, or detailed descriptions exist of the Stanton home, either before or after the remodeling of 1847. It is possible, however, to piece together a general picture of the house based on family writings, maps, tax records, and deeds.

The house was located “on the outskirts of the town, roads very often muddy and no sidewalks most of the way....”⁶² It was “about a mile from the railroad station, situated on high ground overlooking the Seneca River....”⁶³ Mrs. Stanton referred to her house as “my sequestered cottage on Locust Hill,” and—beginning in 1849—as “Grasmere.”⁶⁴ The “locust” may have been descriptive of the locust trees that are still abundant in the area. “Grasmere” is a long lake in northwest England, which she and her husband had visited on their honeymoon; perhaps the nearby Seneca River and Finger Lakes reminded Mrs. Stanton of the Lake District in England.

The house was quite large by all accounts, as would have been necessary to accommodate the ever-growing Stanton family, servants, and frequent visitors. Tax assessment records for the years 1851, 1854, and 1860-62 indicate that the house and the land together were assessed for \$1,500.⁶⁵ In 1860, this put the Stanton property in the top seven percent of assessments when compared with similar properties in the area, suggesting that the Stanton house was comparatively large and well-kept.⁶⁶ Stanton’s son Gerrit later remembered the house as a “mansion...a long

⁶² Stanton, *Eighty Years*, p. 194.

⁶³ Gerrit Smith Stanton, “How Aged Housekeeper Gave Her All to Cause of Woman’s Suffrage” (ca.-1930s news article, Seneca Falls Historical Society).

⁶⁴ Stanton, *Eighty Years*, p. 145, and Guntzel, “History,” p. 4.

⁶⁵ Guntzel, “History,” Appendix D.

⁶⁶ Judith Wellman, “Elizabeth Cady Stanton’s House: Some Thoughts” (typescript, September 1982, p. 2).

rambling house...with wings....”⁶⁷ Maps made of the area in the mid-19th century show the house as a “T” shape in 1852 and an “L” shape in 1856. These maps, however, are large in scale, and their house shapes should be viewed as approximations, rather than accurate drawings.

Exterior Appearance

Very few descriptions of the house’s exterior appearance have been found. The 18-month-old baby was once rescued from “the chimney, on the highest peak of the house” where he had apparently been seated by his brothers.⁶⁸ In a letter to a friend in 1853, Mrs. Stanton described herself “seated on my front piazza in a big chair....”⁶⁹ Henry B. Stanton inquired, “is the gutter up?” in a letter written to Seneca Falls in January 1857.⁷⁰ Several years later in 1862 he wrote, “Boys! Get the leaves and the ice out of the gutter!”⁷¹

Interior Rooms

References to interior rooms are more frequent than descriptions of the exterior of the house, but are similarly lacking in detail. Rooms specifically mentioned include the kitchen, dining room, parlor, bedrooms, nursery, and “chambers” of an unspecified nature. In 1852, Mrs. Stanton wrote to her son Daniel, “I sit in the dining-room alone...and Amelia [Willard] is in the kitchen making bread.”⁷² Based on function, the kitchen and dining room were probably located next to or near to one another. The kitchen may have had a small closet. Writing to her cousin Elizabeth S. Miller, she described her autumn preserving chores “in which dispensation I continued until my little closet and every available bowl & tumbler in the house were filled....The spoons & tables, the knobs of the doors...were all more or less sticky.”⁷³ The kitchen is the logical place to do preserving, so the closet may have been located there. (Alternatively, it may have been in the cellar.) Gerrit Stanton later recalled the house filled with visitors, “and no vacant chairs in the dining room.”⁷⁴ The dining room was also remembered in one of the family stories about Seneca Falls, in which Mrs. Stanton dealt with “a poor neighbor under the influence of liquor...she led him into the dining

⁶⁷ Gerrit Smith Stanton, “Aged Housekeeper.”

⁶⁸ Stanton, *Eighty Years*, p. 164.

⁶⁹ Blatch and Stanton, Vol. II, p. 53.

⁷⁰ Henry B. Stanton to Elizabeth Cady Stanton, January 1857 (Elizabeth Cady Stanton Papers, Library of Congress).

⁷¹ Henry B. Stanton to Elizabeth Cady Stanton, letter dated January 7, 1862, Library of Congress.

⁷² Blatch and Stanton, Vol. II, p. 42.

⁷³ Blatch and Stanton, pp. 53-54.

⁷⁴ Gerrit Smith Stanton, “Aged Housekeeper.”

room, told him to sit down in an easy chair, and be quiet...there she left him, returning to her work in another room.”⁷⁵

The parlor was used by the family, not closed up and reserved for guests. Henry Stanton wrote home to his sons in Seneca Falls in 1852, “shall we not have a good time when we all meet at home, in the parlor—Father, Mother, Daniel, Henry, Gerrit and little Theodore?”⁷⁶ The parlor had at least two doors: Mrs. Stanton wrote that following a disagreement with her father one night in 1855, “he...left the parlor by one door and I...left by another.”⁷⁷

Bedrooms were numerous. Gerrit Stanton remembered that the Seneca Falls house “had many bedrooms...”⁷⁸ At least some of these were located “upstairs,” probably on the second story. Mrs. Stanton wrote in 1852 to absent son Daniel, “the boys [Gerrit and Theodore] are upstairs in bed and asleep.”⁷⁹

Child-rearing was an ongoing occupation at the Stanton House. Mrs. Stanton painted a picture of her busy life in 1853, “singing lullabies at one moment in the nursery and...ditties the next moment on the piano-stool.”⁸⁰ At times she became impatient with the tedium of mothering, and described her discontent to Susan B. Anthony in 1856: “Imagine me, day in and day out [caring for] the precious contents of a little crib in the corner of my room. I pace up and down these two chambers of mine like a caged lioness....”⁸¹

Ventilation

Elizabeth Cady Stanton was a strong advocate of fresh air and ventilation.⁸² Her house in Seneca Falls is said to have reflected this according to a family story. A few years after 1854 at a dinner with Horace Greeley, a Congressman named “Mr. S.” is said to have commented, “every time her husband goes away she cuts a door or a window. They have only ten doors to lock every night, now.”⁸³

⁷⁵ Blatch and Stanton, Vol. I, p. xv.

⁷⁶ Henry B. Stanton to Sons, February 22, 1852 (Elizabeth Cady Stanton Papers, Library of Congress).

⁷⁷ Blatch and Stanton, Vol. II, p. 42.

⁷⁸ Gerrit Smith Stanton, “Aged Housekeeper.”

⁷⁹ Blatch and Stanton, Vol. II, p. 42.

⁸⁰ Blatch and Stanton, p. 50.

⁸¹ Blatch and Stanton, p. 66.

⁸² Elizabeth Cady Stanton, “Home Life” (ca.-1880 lyceum speech, manuscript, Rutgers University), pp. 4-6.

⁸³ Stanton, *Eighty Years*, p. 209.

Heating

Heat was provided to the Stanton home by burning wood. Henry Stanton inquired during one of his absences in the winter of 1857, "have you plenty of wood?"⁸⁴ During a previous winter when the house had been shut up, Henry Stanton visited two or three times and reported to the family, "it was very cold in the rooms; but there is plenty of wood in the wood house, and we could soon warm it up."⁸⁵ Mrs. Stanton later recalled, "night after night, by an old-fashioned fireplace, Susan B. Anthony and I plotted and planned the coming agitation..."⁸⁶ Whether the fireplaces or stoves or both were used for heating is unclear. Stoves were certainly in use by the mid-19th century. Mrs. Stanton herself described in detail helping "our Congressman's wife" pick out a new cooking stove and a sitting room stove in 1854, the pipes of which connected to "dumb stoves above to heat the upstairs rooms."⁸⁷ No such descriptions, unfortunately, are available of the Stanton House heating devices.

Lighting

"Lamps were used to light the houses" during the Seneca Falls years, according to Gerrit Stanton.⁸⁸ Candles appear to have been used by the Stantons to light the way to the bedrooms at night. Mrs. Stanton recalled an evening in 1855 when both she and her father "took a candle" and left the parlor.⁸⁹

Water

Where the Stantons obtained their water, such as from a well or a cistern, is never mentioned in the documentary records. Likewise, a room for washing is mentioned, although we know "the baby [was] accustomed to a morning bath in a large tub..."⁹⁰ Hymen Klionsky of Seneca Falls remembered driving his father's truck in a Seneca Falls parade in 1932 or 1933 with Elizabeth Cady Stanton's bathtub on the back. The zinc-lined tub, said to have been removed from the Stanton

⁸⁴ Henry B. Stanton to Elizabeth Cady Stanton, January 1857.

⁸⁵ Henry B. Stanton to Sons, February 22, 1852.

⁸⁶ Stanton, *Eighty Years*, p. 167.

⁸⁷ Stanton, *Eighty Years*, pp. 205-06.

⁸⁸ Gerrit Smith Stanton, "Aged Housekeeper."

⁸⁹ Blatch and Stanton, Vol. II, p. 61.

⁹⁰ Blatch and Stanton, Vol. I, p. 152.

House, was stolen from the truck that day.⁹¹ There is no way, unfortunately, to verify whether the tub was actually Stanton's or had been installed by a later resident. That the accommodations in the house were in fact old-fashioned, thereby suggesting the latter possibility, may be inferred from Mrs. Stanton's regret at leaving her Boston home "with all the modern conveniences."⁹²

Outbuildings

Outbuildings located on the grounds during the Stantons' residency and mentioned in Mrs. Stanton's writings include a wood house, a smoke house, and a barn. Of these buildings, the 1847 wood house is the only structure known to have been built by the Stantons. The Stanton children seem to have gotten much use of the outbuildings. "[One] time the three elder brothers entered into a conspiracy, and locked up the fourth, Theodore, in the smoke-house.... The three were [then] imprisoned in a garret [of the house?] with two barred windows. They summarily kicked out the bars, and, sliding down on the lightning rod, betook themselves to the barn for liberty."⁹³ The barn was "equipped as a gymnasium for rainy days...[and] a billiard table for the older boys so that they could bring their friends home to play, instead of gathering in the village around a billiard table where they might be tempted to drink, smoke, or gamble."⁹⁴

Grounds

The grounds surrounding the Stanton House comprised "large vegetable gardens...lawns, [and] trees...."⁹⁵ The east and south property lines were bounded from 1845 until at least 1863 by a board fence.⁹⁶ The front (west) side of the property was enclosed in part with a hedge by 1856.⁹⁷ Henry Stanton seems to have taken an interest in the trees and the garden. In a letter home to Seneca Falls dated January 1857 he advised moving "the snow around the apple trees."⁹⁸ In August 1861 he wrote, "I have staid [sic] away so long, that the boys must hoe or have hoed the

⁹¹ Hymen Klionsky to Judy Wellman, conversation August 31, 1982.

⁹² Stanton, *Eighty Years*, p. 145.

⁹³ Stanton, *Eighty Years*, p. 164.

⁹⁴ Alma Lutz, *Created Equal: A Biography of Elizabeth Cady Stanton* (New York: The John Day Co., 1940), p. 100.

⁹⁵ Gerrit Smith Stanton, "Aged Housekeeper."

⁹⁶ Deed Book 58, p. 129 (1845); Deed Book 58, pp. 32-33 (1856); Deed Book 58, p. 134 (1856); and Deed Book 68, p. 148 (1863).

⁹⁷ Deed Book 58, p. 134.

⁹⁸ Henry B. Stanton to Elizabeth Cady Stanton, January 1857.

garden. Also, have grass cut & put around fruit & evergreen trees.”⁹⁹ Lawn furniture and equipment included garden benches; swings, bars, and ladders for the boys; and a flagpole.¹⁰⁰ A flag is said to have been hoisted on the flagpole after the birth of each child, “red for a boy, white for a girl—to let friends know they could visit.”¹⁰¹

Street Address

The year 1862 was the last year that the Stanton family lived in Seneca Falls, and the first year for which a Seneca Falls directory exists. Listed therein is “Stanton Henry B., lawyer” residing at “1 Washington [Street],” and “Stanton Henry B. Jr.” boarding at the same address. Interestingly, Elizabeth Cady Stanton is absent from the directory.¹⁰²

⁹⁹ Henry B. Stanton to Elizabeth Cady Stanton, August 16, 1861 (Elizabeth Cady Stanton Papers, Library of Congress).

¹⁰⁰ Blatch and Stanton, Vol. I, p. xv; Lutz, p. 100; Lois W. Banner, *Elizabeth Cady Stanton: A Radical for Woman's Rights* (Boston: Little, Brown & Co., 1980), p. 49.

¹⁰¹ Banner, p. 49.

¹⁰² *Brigham's Geneva, Seneca Falls & Waterloo Directory & Business Advertiser for 1862 & 1863.*

POST-STANTON PERIOD (1862-1982)

Sale of the Stanton House, 1862

After residing in Seneca Falls for 15 years, the Stanton family moved to Brooklyn, New York, in 1862. In April of that year, Elizabeth Cady Stanton sold her Washington Street home, along with two acres of land, to John S. Edwards of Seneca Falls for \$1,650.¹⁰³ The tax rolls in 1862 list this property as being worth \$1,500, the same amount assigned for the years 1851, 1854, and 1860-62. Edwards and his wife Martha lived in the Stantons' former house for one year only. Early in 1863 they bought, and presumably moved to, a place known locally as the "Usher farm."

Subdivision of the Stanton Lot, 1864

In April 1863, John and Martha Edwards sold their property, which had previously been "conveyed by Elizabeth Cady Stanton," to William A. Duncan for \$1,975.¹⁰⁴ The property was still assessed for \$1,500, according to the tax records for that year. Duncan was listed as a "Bookkeeper" at the "Seneca Knitting Mills" in the 1862-63 directory for Seneca Falls and vicinity. Shortly after his acquisition of the property, he began to divide the two-acre parcel into lots. In August 1863, Duncan contracted to sell one lot at the northwest corner to Edward J. Howard.¹⁰⁵ Six lots were eventually created (fig. 4), as documented by the deeds recording their sales dated August 1864 through April 1870. That the lots were in fact conveyed earlier than the deeds would suggest, however, is apparent from the tax rolls for 1864 completed on or before March of that year. Five of the six lots were then assessed to their eventual or intended owners. One lot, at the southwest corner, remained in the ownership of William Duncan in 1864. Assessed for the most amount of money, \$600, was the lot then assigned to Peter Taylor. This was the lot with the Stanton House thereon. The two lots on either side of Taylor's lot were then described as "vacant."¹⁰⁶ The housing shortage and rising rents reported in the local newspaper in 1864 and 1865 no doubt played a role in the property being divided at this time.¹⁰⁷

Peter Taylor's lot was located approximately in the center of the Stanton's original two-acre parcel. Although Taylor was listed as the owner of record in the tax assessment rolls for 1864, his

¹⁰³ Deed Book 65, p. 270.

¹⁰⁴ Deed Book 68, p. 148.

¹⁰⁵ Deed Book 92, p. 413.

¹⁰⁶ Considerable research on this topic was done by Hanns Kuttner in 1984 and 1985. His findings are written in a "Memorandum for Superintendent" dated December 3, 1984, and a "Summary" dated February 1985. Both are on file at the park.

¹⁰⁷ Guntzel, "History," p. 6.

deed to the property is dated two years later—March 1866.¹⁰⁸ This deed describes the purchase price as \$1,000 and the lot dimensions as 90 feet wide along Washington Street by 230 1/2 feet deep.¹⁰⁹ No reference is made to the house.

Boardman Family Ownership, 1867-1900

By the time Peter Taylor officially acquired his lot on Washington Street in 1866, he was described as being from Syracuse and “late of Seneca Falls.”¹¹⁰ It is therefore not surprising that on that same day he sold the property for \$1,360 to George and William Savage and Burnett B. Boardman, all of Seneca Falls.¹¹¹ Both William Savage and Burnett B. Boardman are listed as farmers in the Seneca County Directory for 1867-68, although no resident addresses are given. George and William Savage sold their share of the property to Burnett Boardman in October of the following year for \$450, thus making Boardman the sole owner.¹¹²

The Stanton House property remained in the possession of the Boardman family for 33 years, but there is no evidence that the Boardmans ever lived there. The Seneca Falls-Waterloo Village Directory for 1874-75 lists Burnet [sic] B. Boardman as a farmer living in a house in the “E. Bayard N. Village limits.” Seven years later, Boardman’s post office address is listed in the 1881-82 Seneca County Directory as “Clifton Springs,” and by 1888 he is not listed at all in the Seneca Falls-Waterloo Directory. Burnett Boardman sold the Washington Street property in 1890 to his son, George P. Boardman, for \$740. Both father and son were then living in Clifton Springs, New York.¹¹³ The Seneca Falls-Waterloo Directory for this year and 1891 lists a “John Byrne, laborer” living in the house at “32 Washington,” the current address of the Stanton House. Assuming that the address has not changed, Byrne was most likely a tenant of George Boardman. The property remained in the Boardman family until 1900.

Seneca Falls Maps: 1871, 1873, and 1896

Seneca Falls maps that were made during the years of Boardman family ownership are dated 1871, 1873, 1874, 1881, 1886, and 1896. Of these maps, only three show the buildings on Washington Street. These are the maps dated 1871, 1873, and 1896.¹¹⁴

¹⁰⁸ Deed Book 72, p. 483.

¹⁰⁹ This corresponds to the size of the Stanton House lot in 1982.

¹¹⁰ Deed Book 72, p. 483.

¹¹¹ Deed Book 76, pp. 144-45.

¹¹² Deed Book 77, p. 23.

¹¹³ Deed Book 108, p. 23.

¹¹⁴ All of the maps mentioned in this section are in the collection of the Seneca Falls Historical Society.

The map of 1871 is entitled the "Map of the Village of Seneca Falls, Seneca County, N. Y.," and was published by W.W. Richie of Philadelphia. It shows the Stantons' former lot at the corner of Washington and Seneca Streets subdivided into four long lots along Washington Street, each with a building thereon. The lot to the far north was owned by "N. Law," the north center lot by "B.B. Boardman," the south center lot by "J. Gargen," and the far south lot by "J. McKeivitt." The map is not entirely accurate, however, since it is known from research in the Registry of Deeds that the Stantons' lot was in fact divided into six separate parcels by this time. It is nevertheless of interest because it shows the Stanton House. This is a crude rendition that portrays the house as a simple rectangular shape oriented with its end facing Washington Street.

The map of 1873 shows considerably more detail, with all buildings drawn in perspective. This is a view looking southwest, so only the north and east (back) sides of the houses are visible on the former Stanton property. Shown on this lot are what appears to be either one large house with many wings, or a group of closely spaced buildings. It is likely that the latter is the case, based on the 1871 map. This map shows that two lots had been created at the north end of the Stanton House lot by this time, with a house on each. This means that on the 1873 map, the Stanton House would be the third house from the corner. Even without its north wing, it appears to be a sizable structure. The artist has shown a main two-story section with three wings. To the north is the main house with its west gable end facing Washington Street. On the back side of the main house is a one-story shed or enclosed porch. What is now the south wing is incorrectly drawn with its gable end facing the street, rather than ridge-parallel to the street. This mistake has been attributed to artistic license on the part of the map maker. Attached to the south wing are two east wings, each progressively smaller than the south wing. Also shown are doorways and windows but no chimneys.

The latest map, dated 1896, is similar to the 1871 map, except that it shows only three lots and three houses on the former Stanton lot. The north and center north lots in the 1871 map were combined by 1896 and owned by "Jos. Kinsella." The 1871 center south lot remained intact in 1896, with the Stanton House on it; it was owned by "Geo. Boardman." The 1871 south lot and house was intact and owned by "Pat Gargen." Boardman's house by this time was drawn as two side-by-side, overlapping rectangles. It is presumed that the north rectangle represented the main two-story house, and the south rectangle the south wing with its attached east wing. This thought is verified by the earliest known photograph of the house, which has been dated "circa 1900."

Photograph, Circa 1900

The earliest known photograph of the Stanton House is a black-and-white view (discolored to brown and cream) that shows the front and south sides of the house. It measures 4 13/16 inches wide by 3 13/16 inches high, is mounted to a cardboard backing, and appears to be an albumen print.¹¹⁵ Written on the back side of the cardboard mount are the words:

Given to A.H. Barben by Anne McGran from Mary Gilmore effects. July
1970. Picture of E.C. Stanton home before remodeling [sic].

¹¹⁵ Albumen prints may be roughly dated between the years 1855 and 1920, according to James M. Reilly, *Care and Identification of 19th-Century Photographic Prints* (Kodak Publication No. G-2S, Rochester, NY: Eastman Kodak Company, 1986).

The original is in the collection of the Seneca Falls Historical Society.

The date of "circa 1900" has been assigned to the photograph for several reasons. It shows the property already subdivided and fenced on the north side, which occurred in 1864. Second, it does not show the extensive alterations of 1902-03, and so predates those years. Third, assessors' records indicate that the house was in poor repair, which would be consonant with its use for the 33 years prior to 1900 as a rental property.¹¹⁶ Finally, the inscription says that the photograph was in the effects of Mary Gilmore. She was the daughter of Hugh and Mary Gilmore, who purchased the property in 1900 and remodeled the house several years later. It seems quite likely that the Gilmore family took the photograph following their purchase of the house in May 1900.

The photograph shows the main two-story house, a 1 1/2-story wing to the south, and another 1 1/2-story wing attached to the east side of the south wing. An open porch is located on the front (west) side of the south wing, along with the front doorway entrance with a three-panel door and sidelights. In the south elevation of the east wing are two more exterior doorways, these fitted with four-panel doors. One of these side doorways is protected by a small shed roof. Three types of window sashes are seen in the windows: nine panes over six panes, six over six, and four over four. All of the window openings but one have exterior louvered shutters. The finish on most of the exterior elements including the siding, cornice, shutters, and porch columns, appears to be a dark color. Only the window sashes and the stiles and rails of the east wing doors are a light color. Paint analysis undertaken as part of the architectural investigation identified the dark color as red, but found no surviving samples of the light color. A water pump with wood platform/cover is located in front of the house, as is a wood plank sidewalk that parallels Washington Street. Signs of disrepair include the collapsed porch floor, the sagging porch roof, and missing bricks in the east chimney. Tax assessments for the years 1890 to 1900 illustrate the progressive deterioration of the house. In 1890 and 1894 the property was assessed for \$800, in 1897 and 1898 for \$750, and in 1900 for \$600. That the house was occupied at the time the photograph was taken is suggested by an open front window and the fact that the front door is ajar.

Gilmore Family Ownership, 1900-1943

George P. Boardman sold his Seneca Falls property on Washington Street in May 1900. Boardman was then a "bachelor" living in Hartford, Connecticut. The property was purchased by Hugh and Mary Gilmore of Seneca Falls for \$500.¹¹⁷ The Gilmores appear to have done little work on the house in their first year of ownership, since the tax assessment for 1901 dropped to \$400 (from \$600 in 1900). It is also possible that the lower assessment is attributable to the demolition of an outbuilding or a portion of the house such as a wing.

Extensive remodeling was undertaken in the early 20th century by the Gilmore family. "Improvements" apparently commenced as early as 1902 and continued through 1903, because the

¹¹⁶ Tax assessments are a questionable form of evidence when not corrected for inflation, and they do not always accurately reflect the trend of property values. However, they can be useful when corroborated by other types of evidence.

¹¹⁷ Deed Book 120, p. 158.

tax assessment rose to \$600 in those years. That the work continued through 1903 is substantiated by a newspaper fragment of that date that was found during the architectural investigation to have been incorporated into the brickwork of the new chimney. The alterations were completed by 1904 according to "*Grip's Historical Souvenir of Seneca Falls, N.Y.*, which noted Mrs. Stanton's house had "been entirely remodeled."¹¹⁸ Coincidentally, the tax assessment rose to \$700 in 1904, and remained this amount for the next five years.

The earliest photograph of the house following the renovations has been dated circa 1904-05. This is based on the age of the little girl in the photograph, Mary Gilmore, who appears to be about four or five years old.¹¹⁹ Only the front (west) side of the house may be seen in this view, along with a barn or shed in the back yard towards the south side. Despite this restricted view, the following changes to the house are evident when compared with the earlier photograph of circa 1900:

- south-wing raised to two stories;
- south-wing chimney removed;
- new south-wing chimney built;
- new porch built on west elevation of south wing;
- roof cornice of south wing and main house altered;
- gable-end pediment of main house shingled;
- window sashes changed to one-over-one lights;
- new louvered window shutters installed;
- main body of the house and porch painted a light color, and window sashes and shutters painted a dark color; and
- exterior water pump mounted on a round mill stone.

The next photograph is a post card view that shows the west and south elevations of the house. The date of this post card is not known, but two aspects suggest a date of circa 1915. First, no bushes have yet grown around the foundation. Second, the post card shows the small shed that was added to the east side of the east wing. This shed addition may have been built sometime between 1909 and 1911, when the tax assessment increased from \$700 to \$850. The card is tinted, showing the siding a light gray color and the trim and porch columns white. However, one must remember that such tinting was often based on artistic license rather than fact.

The post card shows that—like the west elevation—the south elevation of the south wing and the east wing appeared quite different from their appearance in the circa-1900 photograph. These changes were probably part of the renovations done by the Gilmores in 1902-03 and include:

- former east wing replaced by a smaller east wing;
- gable-end pediment of south wing shingled;
- two first-story windows installed in the south elevation of the south wing;
- cellar window installed in the south elevation of the south wing; and
- exterior cellar entrance and bulkhead constructed on the east side of the south wing.

¹¹⁸ Edgar L. Welch, "*Grip's Historical Souvenir of Seneca Falls, N.Y.* (Syracuse, 1904), p. 30.

¹¹⁹ Guntzel, "History," pp. 6-7.

Harriot Stanton Blatch, Mrs. Stanton's youngest daughter, cited alterations made to the house in an anniversary speech to the National Woman's Party in Seneca Falls on July 20, 1923:

Mrs. Stanton was domiciled just over there, only a fraction of the house still stands, changed as the [Wesleyan] Chapel greatly. With wings clipped and its acres of shaded lawn and gardens cut to meet the needs of a growing neighborhood, it gives but a hint of the days of seventy-five years ago....¹²⁰

The Sanborn Insurance Map of 1925 (later corrected to 1955) is the first fire insurance map of Seneca Falls that includes the Washington Street area. Three frame dwellings are shown on the lot numbered "32" on Washington Street: a dwelling (the Stanton House), a one-story auto garage, and a 1 1/2-story shed with one-story wing at the rear of the property. The dwelling is composed of two two-story sections in an L configuration, a small one-story front porch, and a small one-story rear wing. The dwelling is located close to Washington Street, the auto garage to the southeast of the dwelling, and the large shed directly to the east (rear) of the dwelling near the back property line. This shed is probably the one seen behind the Stanton House in the circa 1904-05.

The next photograph, dated circa 1920s, appears to have been taken after the circa-1915 post card view because bushes have grown up along the foundation of the east elevation. Similar to the circa 1904-05 photograph, only the east elevation of the house is shown. To the southeast of and set back from the house is a small gable building. This is probably the auto garage included on the Sanborn map of 1925. It is not seen in the photograph of circa 1904-05 and was therefore built sometime after that date. The tax assessment for 1919 includes a "shop" for the first time, coincidental with a \$50 increase, perhaps due to the new garage. The east elevation of the house itself has not changed significantly from the views of circa 1904-05 or circa 1915. The only difference appears to be the paint on the porch, where the upper columns have been changed to a dark color (similar to the body of the house), while the lower columns and railings have been painted a light color. Some white trim on the main house is evident, although it is worn looking.

Sometime not long after the circa-1920s photograph, another photograph was taken. This view has been dated "circa 1930s" based on the style of the automobile and the size of the bushes in front of the house. Changes made to the house by this time include the installation of shingle siding, removal of the window shutters, and painting all of the exposed trim a light color. Although it is not within the range of the photograph, a historical marker was also installed in front of the house in the 1932 by the New York State Education Department.

Mary C. Gilmore sold the Stanton House property in June 1943 to Gerald and Mary Ann Pagano of Seneca Falls for \$2,500. Mary Gilmore was the daughter of Hugh and Mary Gilmore and the executor of her father's estate.¹²¹ The Paganos lived in the house just under 2 1/2 years before selling it to Stanley and Helen Burroughs, also of Seneca Falls, in October 1945.¹²²

¹²⁰ Blatch, "Address to the National Woman's Party Anniversary Celebration," July 20, 1923 (Stanton Papers, Library of Congress).

¹²¹ Deed Book 187, p. 164.

¹²² Deed Book 190, p. 467.

Burroughs Family Ownership, 1945-1978

The Burroughs family owned the Stanton House property for the next 30 years, from 1945 until 1978. Many improvements were made to the house during that time. A short film clip of the 1948 National Woman's Party anniversary celebration shows the front porch in the process of being enclosed.¹²³ T.J. Casamassima, who grew up across the street from the Stanton House, helped Mr. Burroughs do painting and other improvements. Casamassima remembers painting the exterior of the house green in the spring of 1972. He also recalls that the house had previously been white, except for the shingles in the east gable pediment that had no paint. Interior rooms were also painted that summer. Some of the colors used were bright green (for the porch), yellow, and beige. Sometime after 1972, Casamassima remembers removing a porch from the east end of the east kitchen wing and building an enclosed porch. A bathroom was added on the first story by Disaro Contractors. Wood paneling was installed in some of the rooms by Mr. Burroughs, as was a drop ceiling in the front room (Room 101) after the plaster ceiling had fallen. The west bedroom (Room 201) was used by the Burroughs family for storage, the east bedroom (Room 202) as the master bedroom, and the south bedroom (Room 204) as the daughters' room. Room 102 was also used as a bedroom by Mr. Burroughs' mother for a short while before it was paneled.¹²⁴

Ralph Peters and the Stanton House, 1978-1982

In September 1978, Stanley and Helen Burroughs—who were then living in nearby Waterloo—sold the Stanton House property to Ralph Peters of Seattle, Washington.¹²⁵ Peters' intention was to keep the house off the market until it could be purchased by the Elizabeth Cady Stanton Foundation.¹²⁶ In the meantime, the house was cared for by live-in caretaker Lucille M. Povero. Peters transferred the property to the Stanton Foundation on January 6, 1982.¹²⁷ The Stanton Foundation in turn transferred the property to the National Park Service on June 29, 1982.¹²⁸ Women's Rights National Historical Park was officially dedicated the following month in July 1982.

¹²³ Guntzel, "History," p. 7.

¹²⁴ T.J. Casamassima to Barbara Pearson, conversation June 7, 1982.

¹²⁵ Deed Book 380, p. 542.

¹²⁶ *The Reveille*, "Convention Days '82" issue, Seneca Falls, New York, July 14, 1982.

¹²⁷ Recorded April 1, 1982. Registry of Deeds, Book 393, Deeds page 720.

¹²⁸ Registry of Deeds, Book 394, Deeds page 607.

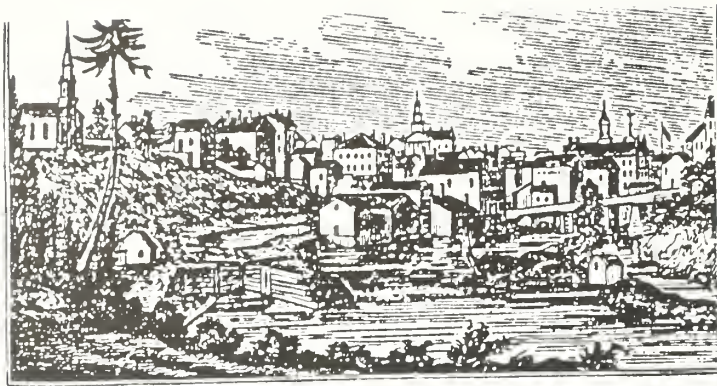

EAST VIEW OF SENECA FALLS VILLAGE.

1841.

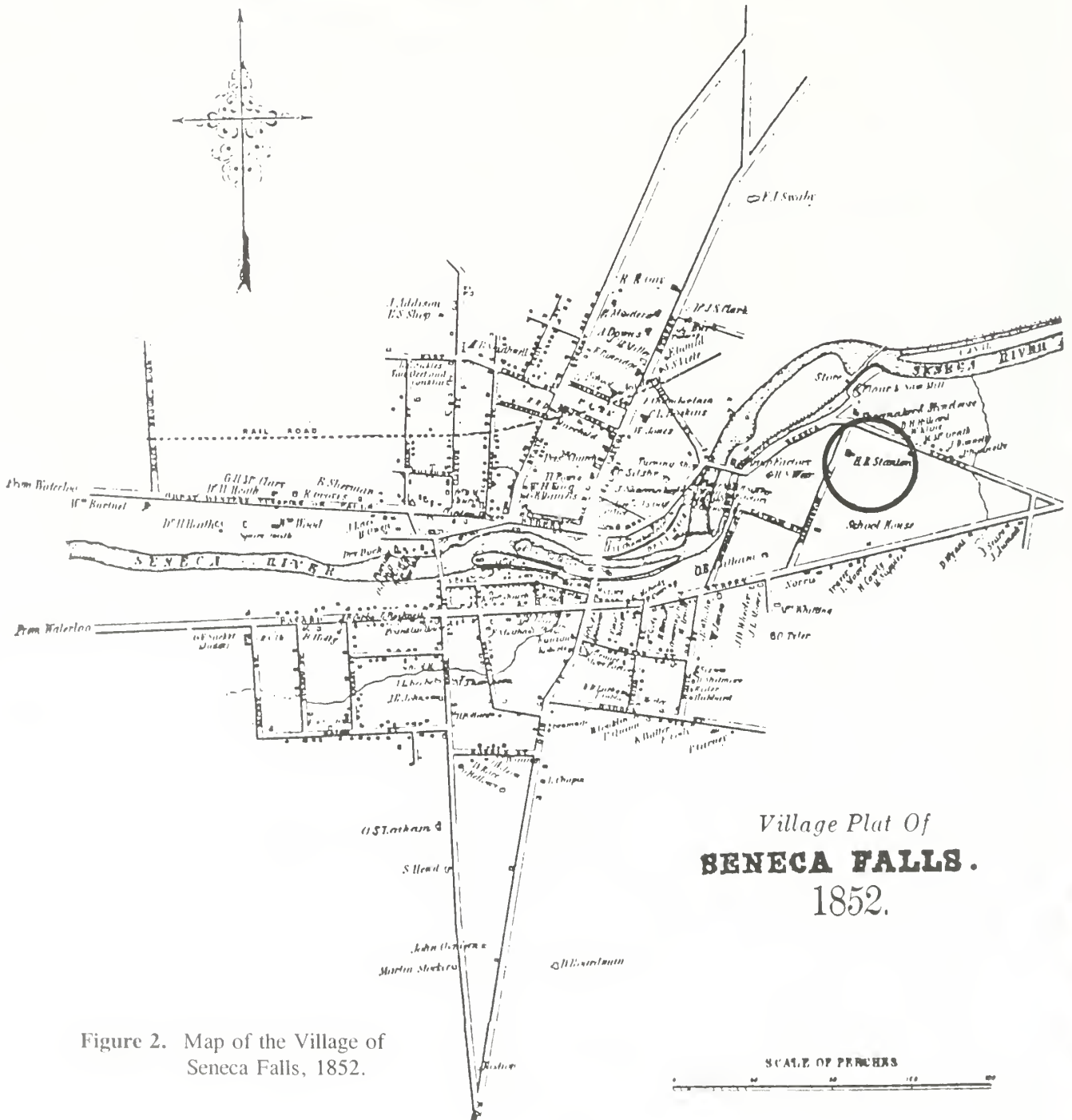

Figure 2. Map of the Village of Seneca Falls, 1852.

VILLAGE OF SENECA FALLS.

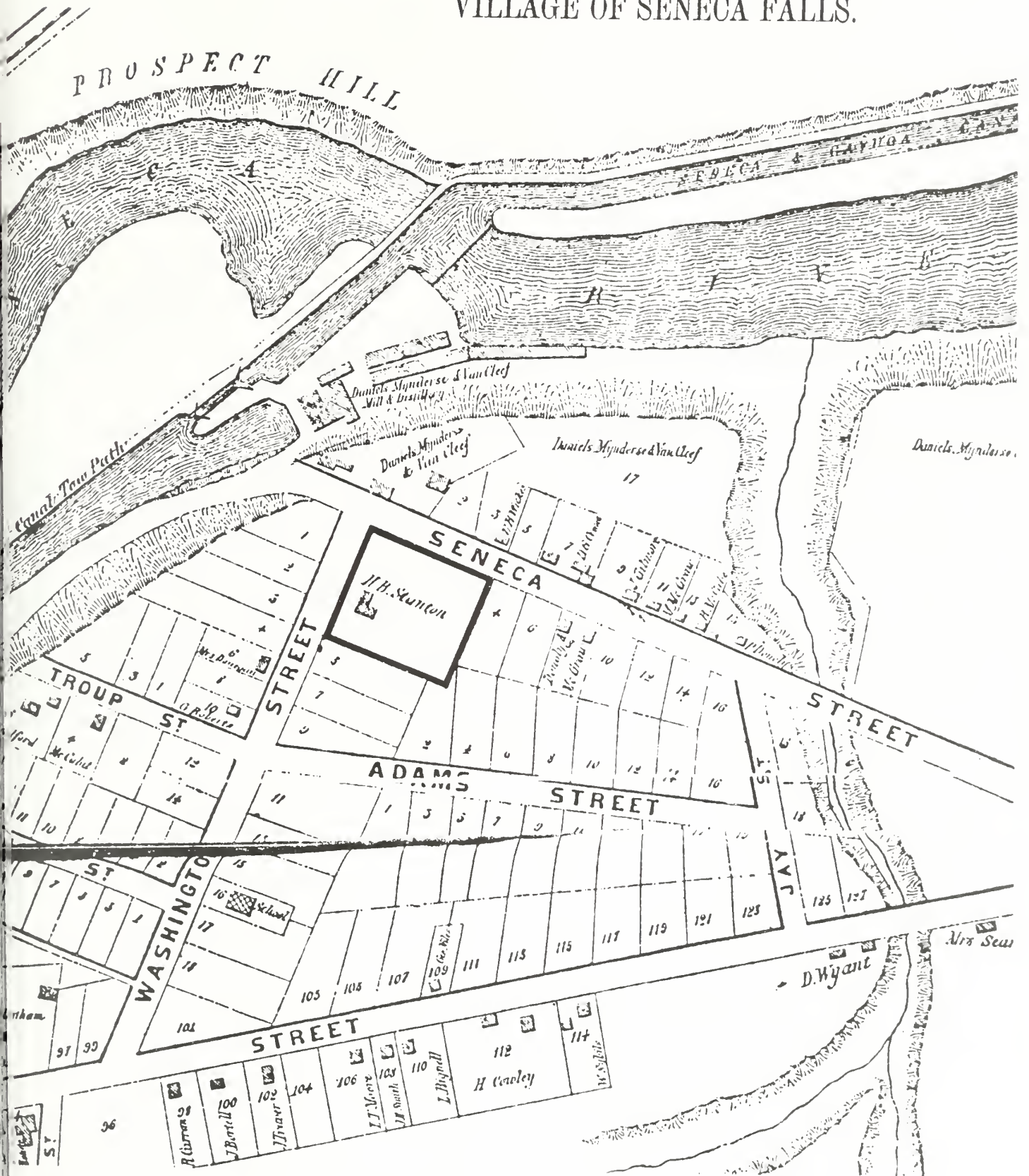

Figure 3. Cadastral wall map (detail) by J.H. French, 1856.

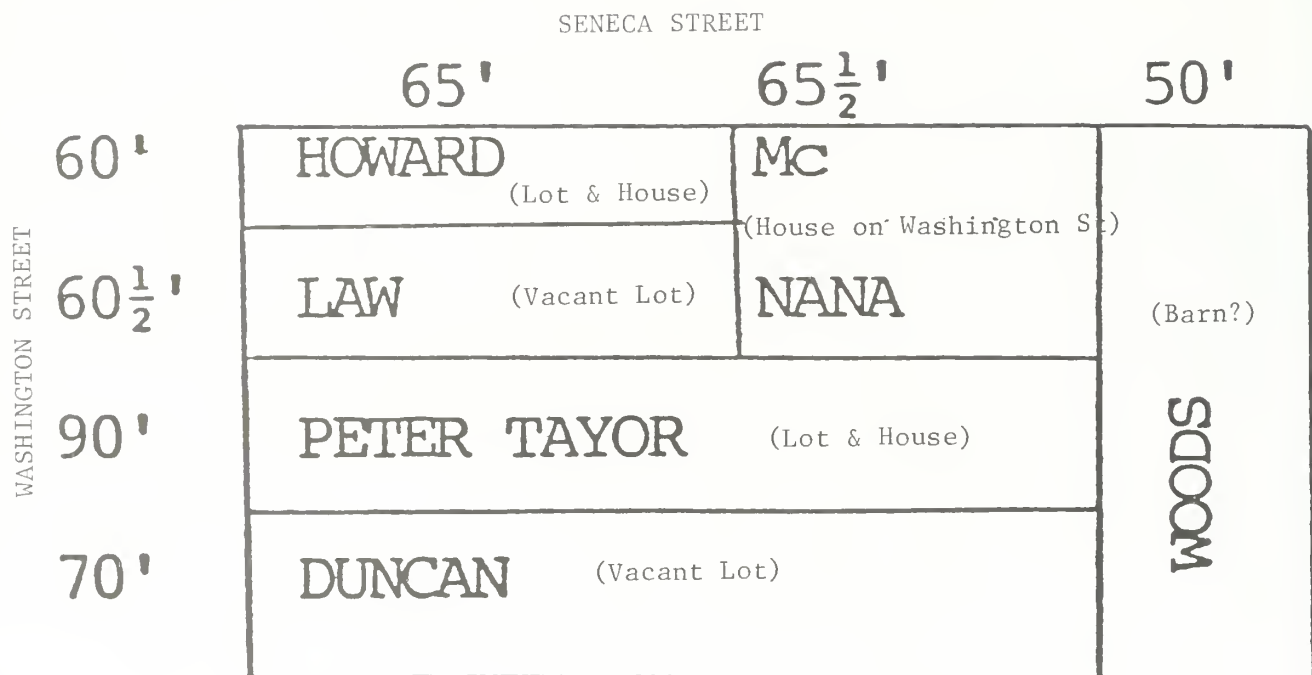

Figure 4. Subdivision of the Stanton lot, as suggested by the tax assessment of 1864.

BIRD'S EYE VIEW OF
SENECA FALLS, N. Y.
1873.

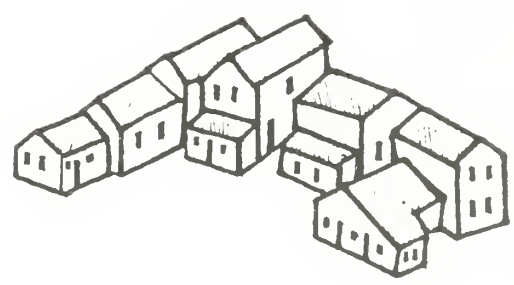

Figure 6. "Bird's Eye View of Seneca Falls, N.Y." (detail), 1873.



Figure 7. Map of Seneca Falls (detail), 1896.

▲
N



Figure 8. Earliest exterior photograph of the Stanton House, circa 1900.



Figure 9. Stanton House: west elevation, circa 1904-05.



HOME OF ELIZABETH CADY STANTON, SENECA FALLS, N. Y.

Figure 10. Stanton House: west and south elevations, circa 1915.

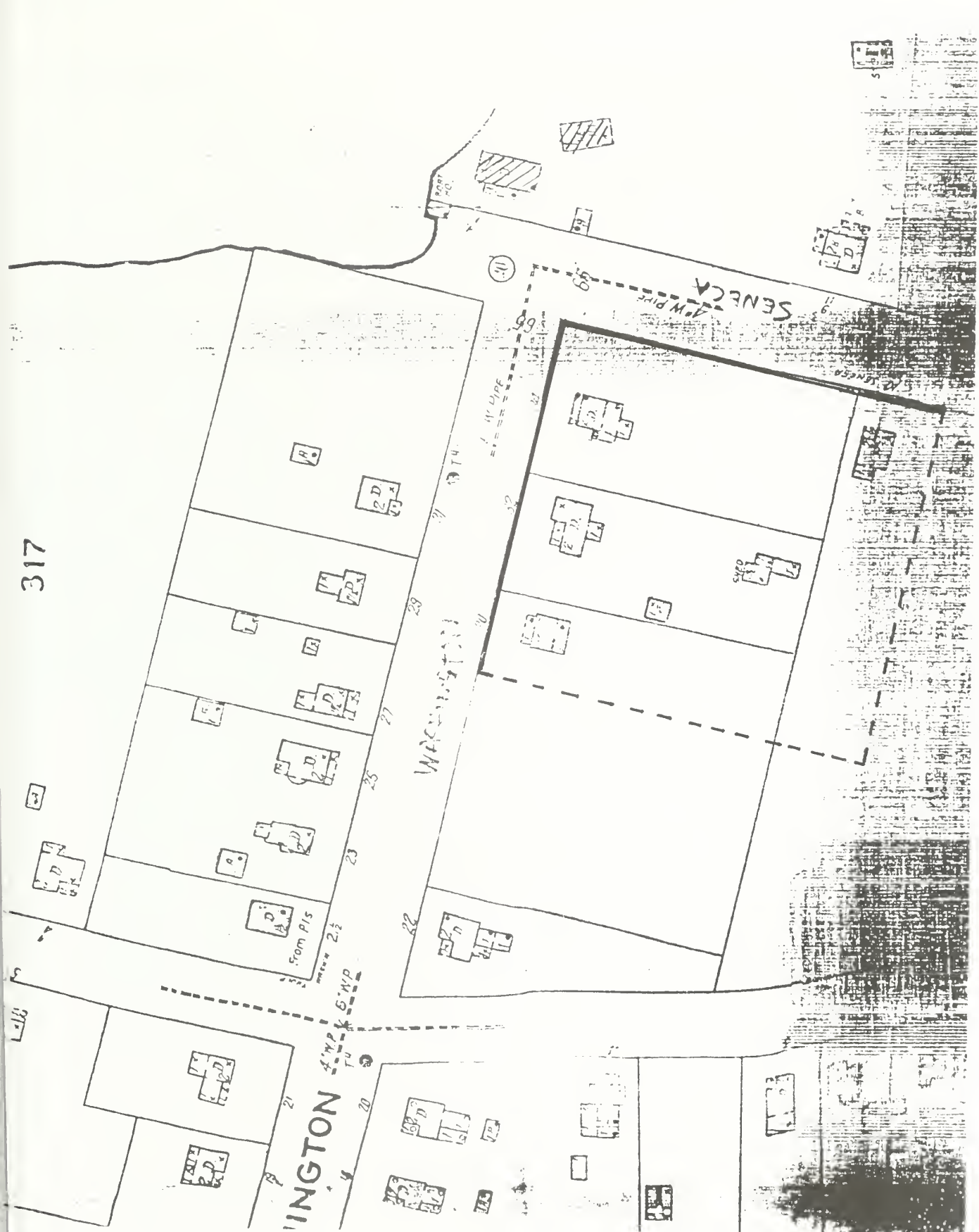

Figure 11. Insurance map "Seneca Falls, New York" (detail), 1925 corrected to 1955.

▲
N



Figure 12. Stanton House: west elevation, circa 1920s.



Figure 13. Stanton House: west elevation, circa 1930s.



Figure 14. Stanton House: west and east elevations, July 19, 1968.

III. PHYSICAL INVESTIGATION AND ANALYSIS

ARCHITECTURAL INVESTIGATIONS

Background

As may be surmised from the "Historical Background" section of this report, very little written or graphic information has survived on the appearance of Elizabeth Cady Stanton's house prior to circa 1900. Although we know from photographs that extensive alterations were made in 1902-03, the house itself still provides the most valuable information for determining its appearance during the time the Stanton family lived there from 1847 to 1862. Historic building materials are commonly preserved beneath modern materials such as plasterboard and wall-to-wall carpeting. Old plaster and wallpaper become covered over by later additions or fall into protected areas such as wall cavities. Old woodwork is sometimes found in odd locations, having been reused by a frugal renovator. Missing historic architectural features, such as a staircase or window, may even be identified with some detective work. Clues to look for include structural-framing anomalies, patches, paint lines, plaster marks, and nail holes. The building materials themselves may be dated by examining their stylistic characteristics, nails, lath, and wallpaper. Mortar and paint, when studied in context and comparatively, are also helpful in interpreting the architectural evolution of a building.

Methodology

An organized approach to the study of the Stanton House building materials was important in order to make a systematic evaluation. To this end, individual rooms and wall cavities were numbered, and a cataloging system established. First, numbers 101 through 105 were arbitrarily assigned to the rooms on the first story, and numbers 201 through 204 to the rooms on the second story. Second, wall cavities—located between the interior walls and the exterior siding, and defined by studs and braces—were individually labeled as explained in Appendix E. Third, a cataloging system was set up to keep track of historic woodwork that had been reused during the renovations of circa 1880 and 1902-03. A three-part catalog number was devised that included "WORI" for Women's Rights National Historical Park, "01" for the Stanton House, and "R001" for reused item number one. Thus, reused item number four would have catalog number "WORI 01 R004." Similarly, samples of nails, mortar, paint, and wallpaper were given three-part catalog numbers, with the "R001" substituted by "N001" for nails, "M001" for mortar, "P001" for paint, and "W001" for wallpaper.

Documentation

The first step in the architectural investigation of the Stanton House was to record, both photographically and schematically, the existing conditions of the building in June 1982. Mortar and paint were taken from both modern and suspected older features for preliminary examination and comparison. Following this initial recording and sampling, selective removal of obviously modern materials (such as plasterboard and acoustical ceiling tiles) was begun in July 1982 by a National Park Service restoration crew under the supervision of Exhibit Specialist John T. Darcy. Measured

architectural drawings were made of the house by the Historic American Buildings Survey (HABS) soon thereafter. Recording and sampling continued to be done concurrently with this work.

Historic Building Materials

It soon became apparent in the course of the architectural investigation that considerable historic (i.e., Stanton period or earlier) material remained in the Stanton House. Early structural elements included the foundation walls, the post-and-beam structural frame, and the roof rafters and sheathing boards in both the main house and the south wing. Much old lath and plaster remained in the main house, and small amounts in the south wing. Plaster and layers of old wallpaper survived on the walls behind additions made in 1902-03, such as partition walls and the south wing's chimney. Most floorboards and some pieces of interior trim remained in their original locations, secured with early machine-cut nails. Window and doorway architraves on the first story were in the Greek Revival style, which roughly spanned the years 1820 to 1850.¹ Those in the main house were in a later Greek Revival style made popular by Minard Lafever in 1835.² Close inspection revealed that this woodwork was an alteration, although it was most likely in the house when the Stanton Family lived there.

In addition to historic building materials preserved in situ, plaster and wallpaper were also found to have survived in locations other than from their original ones. Large sheets of plaster with wallpaper attached were discarded beneath the new front porch in 1902-03. Fragments of early plaster and wallpaper were also found in the wall cavities. That a significant amount of artifactual debris had accumulated in the wall cavities was discovered in the process of removing the exterior board siding to check the structural framing conditions. cursory examination of these cavities turned up not only large amounts of plaster keys and rodent nests, but also early wallpaper fragments and an Indian Head penny dated 1859. It was therefore decided to number the cavities, empty the contents of each cavity into plastic bags, and systematically sort through the debris. Significant items retrieved and recorded were brick fragments from cavities adjacent to missing early chimney stacks, coal nuggets, fragments of window glass, plaster with painted finishes, glass buttons, a hexagonal black glass bead (such as from a woman's dress), straight pins, women's hair pins, a ceramic fragment, and fragment of lead-glazed earthenware. Generally speaking, plaster and wallpaper fragments were identified to have originated from the room contiguous to the wall cavity. In some cases, however, it was also recognized that painted plaster had fallen from the second story into the wall cavities on the first story. This was particularly important in determining the historic appearance of Room 204, which had been completely gutted of old plaster and woodwork in 1902-03. Painted wall plaster from this room with a distinctive light blue paint was found to have fallen into the first-story wall cavities of Room 104, thus providing the otherwise-unavailable paint history of the room. Based on this paint evidence, it was then possible to identify the missing baseboards that had been removed and reused in new locations in 1902-03.

¹ Howard Major, *The Domestic Architecture of the Early American Republic: The Greek Revival* (Philadelphia: J.B. Lippincott Co., 1926), p. 7.

² Minard Lafever, *The Beauties of Modern Architecture* (1835, reprinted in 1839, 1849, and 1855).

A large amount of historic woodwork, in addition to the baseboards from Room 204, was found to have been preserved in "reused" locations in the Stanton House. While the renovations of 1902-03 comprised the bulk of this material, alterations made circa 1840 and circa 1880 also utilized old woodwork. Interior woodwork was discovered to have been reused as structural elements in the floors, walls, and ceilings. This included floorboards, baseboards, doorway and window architraves and jambs, portions of the curved staircase missing from Room 103, and two sections of the fireplace mantel missing from Room 104. Also "encapsulated" in the house were exterior elements such as sections of the south wing's front (west) doorway, cornice pieces, a section of corner board, skirt boards, and siding boards. More visible reuse locations were also identified, such as the mantel in Room 101 that had been relocated from the north wall to the east wall. Doorway frames and architraves on the second story had been relocated to new partition walls, and two interior four-panel doors had been relocated to different rooms. Determining the original locations of these reused elements involved comparing paint samples and molding profiles of reused items with extant historic fabric, aligning nail holes, and studying the exterior historic photograph dated circa 1900. A total of 196 reused items were cataloged as previously described, with the three-part catalog number written in indelible ink either directly on the object or on an attached artifact tag. This number was then recorded on an inventory sheet, along with the item's reuse location, description, nail types, paint samples taken, and the original location if this could be determined. This inventory is included in its entirety in Appendix F.

Evidence of missing Stanton-period architectural features came to light as later alterations continued to be identified and removed. Two former wings, one on the east side of the south wing and another on the north side of the main house, had left their marks on the existing house in the form of flashing nails, lath, and plaster. Foundation walls for these wings, uncovered by archeologists in 1980 and 1983, are discussed later this report. In the extant house, two staircases to the second story were located in the south wing based on cutouts and subsequent patching in the second floor joists, lath nails in the joist ends, and painted outlines or impressions on the first floor floorboards. Two chimney stacks, one in the south wing and the other in the main house, had been removed in 1902-03. Remaining physical evidence for the chimneys was found in the form of the structural framing in the first and second stories, brick footings in the cellar of the main house, a stone base foundation in the cellar of the south wing, and fragments of bricks in the contiguous wall cavities. The locations of missing partition walls and closets were identified based on painted outlines on the floors, plaster marks (or lack thereof), and later patches in the plaster walls and ceilings.

In addition to recording architectural evidence at the house itself, samples of building materials were removed for detailed examination and analysis at the North Atlantic Historic Preservation Center (NAHPC) in Boston, Massachusetts. These included nails, mortar, and paint.

Nails

Two types of nails were identified in the 93 nails sampled at the Stanton House: wire and machine-cut. Wire nails did not come into wide use in the United States until the 1890s, and were found in the Stanton House in association with the alterations of 1902-03 and later.³ The machine-cut nails were all observed to have machine-made heads, usually found after 1815.⁴ Based on associated woodwork, the machine-cut nails that would have been extant during Elizabeth Cady Stanton's time have round ends and shanks clasped for heading on either the cut or the uncut edges of the nails. All machine-cut nails that postdate Stanton's occupancy of the house (i.e., after 1862) have sheared ends and shanks clasped for heading on the uncut edges. Detailed descriptions of the nails samples and their locations are included in Appendix A.

Mortar

All of the mortar sampled at the Stanton House is a lime/sand mixture that was used to lay or patch brick and stone walls, or to plaster the interior walls. Eighty-one samples were taken and transported to the NAHPC in Boston for examination. This involved recording paint layers (if any), separating out the sand components, and/or running a mortar analysis. The paint-analysis procedure is described in detail in the following paragraph. Sand separations, accomplished using hydrochloric acid diluted in water to dissolve the calcium carbonate, were done on 51 of the 81 samples. Separations were done for plaster samples only to quickly distinguish a 1902-03 plaster, which used white sand, from earlier plasters that used brown sand. Analysis was undertaken in order to determine sand and lime proportions for comparison purposes. Based on this analysis, six periods of mortar were identified. These periods were tentatively dated circa 1820s, 1837, 1839, 1840, 1880, and 1902-03, based on the sample locations and associated features such as nails and lath. Mortar sample locations and analysis results are included in Appendix B.

Paint

Small samples of paint, 445 total, were extracted from exterior and interior painted features using an X-Acto knife fitted with a number-18 blade. The samples were placed into individually labeled envelopes and transported to the NAHPC in Boston, where they were studied in cross-section under a Bausch and Lomb stereozoom microscope at up to 70 times magnification. Spot chemical tests were done to identify lead paints by using sodium sulfide, and calcimine paints by using diluted hydrochloric acid. Each paint layer was recorded and its color and individual characteristics noted. Dating of paint layers was accomplished using various types of information such as date of installation, stylistic characteristics, associated nail and wallpaper types, and exterior photographic documentation. Painted woodwork that had been reused and subsequently encapsulated within the

³ W.F.M. Goss, *Bench Work in Wood* (Boston: Ginn & Co., 1887 and 1890), p. 158.

⁴ Lee H. Nelson, *Nail Chronology as an Aid to Dating Old Buildings* (Nashville: American Association for State and Local History, 1968).

floors, walls, and ceilings was especially helpful in dating paint layers. Descriptions of the paint samples and their locations may be found in Appendix C ("Paint Analysis"), Appendix E ("Contents of Wall Cavities"), and Appendix F ("Reused Woodwork").

Wallpaper

A remarkable inventory of wallpapers was found to have survived at the Stanton House, dating from the late 1830s to the early 1940s. Forty-one samples were recovered from various locations such as extant walls and ceilings, wall cavities, and a refuse pile under the front porch. A sample of wallpaper was usually composed of multiple layers of papers. The most layers, 17 total, were found in Room 104. Separation of wallpaper layers was carried out at the NAHPC in Boston, where papers were soaked in warm water and then carefully pried apart with a spatula. The papers were then dried on acid-free blotting paper. After drying, the separated papers were recorded photographically using color slide film. Dating of the wallpapers was based on the substrate characteristics (plaster, lath, and lath nails), the paper type, and the design printed on the paper. Papers found attached to 1902-03 plaster were known to be of 20th-century vintage, while papers on 19th-century plaster might be earlier. Wallpapers made after 1835-38 were machine-made and characterized by the absence of the regularly spaced horizontal seams that would be found in earlier hand-made papers.⁵ No hand-made wallpapers were identified at the Stanton House. Another datable paper characteristic is the fiber composition. Papers were composed of rag fibers until around 1855, when less-expensive wood-pulp papers came into use.⁶ Wood-pulp papers are easily identified by a spot chemical test known as the "Borrows Greenwood Test."⁷ All wallpapers identified as being from the Stanton period (1847-62) were found to be composed of rag fibers, not wood pulp, based on this test. Stylistic characteristics of the wallpaper designs were also useful dating devices, since popular designs changed over time.⁸ A list of the wallpaper sample locations, together with the wallpaper chronology for each room, is included in Appendix D.

Circa-1900 Photograph

One last tool used in the Stanton House building fabric study was the circa-1900 exterior photograph previously described in the "Historical Background" section. Although some features of this photograph probably postdate the Stanton period, such as the four-over-four window sashes,

⁵ Catherine Lynn, *Wallpaper in America: From the Seventeenth Century to World War I* (New York: W.W. Norton & Co., Inc., 1980), p. 41; and Leander J. Bishop, *American Manufacturers From 1608 to 1860* Vols. II & III (Philadelphia: Edward Young & Co., 1868), p. 306.

⁶ Harold J. Plenderleith and A.E.A. Werner, *The Conservation of Antiquities and Works of Art* (London: Oxford University Press, 1976).

⁷ F.D. Armitage, *Atlas of Paper-Making Fibers* (1957).

⁸ Lynn, *Wallpaper in America*, and consultation with wallpaper expert Richard Nylander of the Society for the Preservation of New England Antiquities on February 1, 1983.

this view is still valuable because it is the earliest known photograph of the house. It was therefore studied in minute detail. The original print was borrowed from the Seneca Falls Historical Society, and photomicrographs were taken at up to five times magnification using the Bausch and Lomb stereozoom microscope. The film used was black-and-white ISO 125. Eighty shots were taken, focusing on every element of the house and yard. The prints resulting from this procedure were remarkably concise in detail, due in large part to the high resolution (i.e., fine grain) of the original print. The photomicrographs were most particularly useful in determining the historic appearance of missing exterior elements such as the front doorway, the window shutters and sashes, the roof cornices, and the south wing's front porch and chimney.

ARCHEOLOGICAL INVESTIGATIONS

Background

The Stanton House property was the subject of three archeological investigations in the 1980s. They were designed to collect information about historic but missing wings and porches, and about two features within the cellar of the extant house.

The existence of a north wing and an east porch on the main house, and of a pre-1903 east wing appended to the extant south wing, was known prior to the archeological investigations. The historic north wing was recalled by architectural evidence remaining on the north wall of the extant main house. The existence of an east porch was suggested by architectural evidence for two French doorways in the first-story east wall; such doorways would have normally opened onto a porch. The historic east wing is seen in a circa-1900 photograph that shows the front and south sides of the house. The south wall of the wing had two doorways and two windows. The width of this wing—14 feet, 6 inches—was revealed when a notch for an east-wing roof girt was uncovered during restoration in the east wall frame of the existing south wing.⁹

Investigation of the East Wing - 1980

The first investigation, which focused on the historic east wing, was conducted by Dr. Paul Grebinger of Eisenhower College in 1980. This was before the smaller ca.-1903 east wing was removed by the NPS. However, since the latter was wider but shorter than the historic wing, he was able to work in the presumed location of the east end of the east wing. He did uncover portions of a foundation and recover some artifacts, but no report on his work was available by the time the second investigation of the east wing took place in May 1983.

Investigation of the Wings and Porches - 1983

This project, undertaken by a four-person crew of NPS archeologists after the ca.-1903 east wing was removed, was more extensive than the 1980 investigation. It was supervised by Linda Towle, Project Lead Archeologist, with assistance from Dr. Dick Ping Hsu.¹⁰ Dr. Grebinger showed them the artifacts he had recovered in 1980, loaned them his photographs, and provided them

⁹ Research files, North Atlantic Historic Preservation Center.

¹⁰ Dick Ping Hsu and Linda Towle, "Report on the Archeology of the Stanton House, Women's Rights NHP" (Boston: Division of Cultural Resources, North Atlantic Region, National Park Service, November 1983).

with a copy of his field map. He also provided them with copies of two papers that were prepared about his Stanton House data.¹¹

Archeological testing was performed at four locations on the Stanton property (fig. 15), as follows:

- Area E: the vicinity of the historic east wing;
- Area N: the vicinity of the north wing;
- Area P: the vicinity of the presumed east porch; and
- Area W: the vicinity of an intended trench for utility wires (for Section-106 compliance).

Transects were laid out across each area, and excavation units were defined along each transect. The excavation units varied in size from 1' by 3' to 3' by 3'.

Area E (East Wing)

Features found by the team included, from east to west, the following:

- A north-south foundation wall, 18 inches thick, located at a distance of 34 feet 3 1/2 inches from the east wall of the extant south wing.
- An area paved with bricks one brick deep, laid east-west in sand, without mortar; this area begins at the 18-inch foundation wall and extends westward for a distance of 4 feet; it runs the entire width of the wing, and is located 8-9 inches below the 1983 grade.
- An area paved with fieldstone slabs, also covering the width of the wing; it extends westward from the brick paving a distance of 5 feet.
- Another north-south foundation wall, 10 inches thick and located just west of the fieldstone paving; it does not extend the entire width of the wing, stopping short of the adjacent north and south foundation walls.

The archeological team interpreted this evidence as follows: the wing as it existed before the Stantons' arrival extended only to the 10-inch foundation wall. As part of Mrs. Stanton's repairs to the house in 1847, she extended the wing eastward to the 18-inch foundation wall, and built a new hearth (the brick-paved area) and interior brick kitchen fireplace. This would explain her statement, "I set the carpenters, painters, paperhangers, and gardeners at work, built a new kitchen and wood house, and in one month took possession."¹²

¹¹ Paul Grebinger and Corinne Guntzel, "The Domestic Economy of Elizabeth Cady Stanton: Her House and Its Artifacts" (typescript, 1981); and Jeff Hoffman, "The Excavation at the Stanton House: A Comparison of Two Provenances" (typescript, 1983).

¹² Elizabeth Cady Stanton, *Eighty Years and More: Reminiscences 1815-1897* (New York: Schocken Books, 1971), pp. 144-45.

The NAHPC architectural staff that had conducted the 1982 architectural investigation interpreted the information somewhat differently, based on the following:

- Using the technique of reverse perspective on the ca.-1900 photograph, they determined that the wing was only about 28 feet long. This would have placed the east wall at the joint between the brick paving and the fieldstone paving.
- The area of brick paving seemed unlikely to have been Stanton's hearth. The bricks were laid east-west, rather than north-south as would have been expected, and they had no mortar. The expanse of paving would suggest an old-fashioned open fireplace, rather than the stove that Stanton probably would have used. Finally, this scenario would suggest that the floor of Stanton's kitchen was 8-9 inches below grade.
- It appears as if brick paving had to be taken up to allow the fieldstone paving to be laid.
- Mortar analysis suggested that the 18-inch-thick east wall predated not only 1847, but also 1837 (see Appendix B).

The architectural team concluded that the historic east wing was built ca. 1837 with its east end overlapping the remains of a small, earlier structure with a brick floor. At that time, the portion of brick paving covered over by the wing was taken up, and the fieldstone paving was laid as a base for the wing's brick hearth and chimney.¹³ Mrs. Stanton's 1847 kitchen renovations would not have included lengthening the east wing.

Further archeological research, conducted with assistance from architectural investigators and historians, might be able to resolve these seemingly contradictory conclusions.

Area N (North Wing)

The area where the north wing of the house had been located was labeled "Area N." Excavation here began simultaneously with work in Area E. The placement of excavation units in Area N was based on the supposition that the dimensions of this wing would have been approximately the same as the dimensions of the existing south wing. The front elevation of the house therefore would have been symmetrical as was in keeping with the Greek Revival style.

The northeast corner of the wing was found where it had been expected, at the edge of Transect N-2. Excavations to determine the location of the northwest corner of the wing were not undertaken because the dimensions of the wing are so close to those of the extant south wing that the location of this corner can be assumed with reasonable certainty. Another consideration was the fact that the northwest corner was most likely located in the middle of the paved driveway of the adjacent Hawker house, and excavations there would have inconvenienced the residents. In addition, excavation time was limited, and the east wing and porch areas were given higher priority.¹⁴

¹³ Research files, North Atlantic Historic Preservation Center.

¹⁴ Hsu and Towle, p. 5.

Area P (East Porch)

This area was excavated following the completion of Area N. No evidence was found of an external stairway or porch in this location. However, a wall of undressed slab stone was discovered about 17 inches wide running eastward from the main house for a distance of 8 feet. This was identified as the north wall of a pre-Stanton bulkhead entrance to the cellar. The wall lines up with a joint in the interior cellar wall where the doorway to the bulkhead was closed. Also found were a terra-cotta drain pipe covered with an iron sheet; a single layer of brick paving at a depth of 10 inches below grade approximately 16 feet from the back of the house; a post mold; and the northern edge of a well, possibly used during the Stanton occupation of the house.¹⁵

Investigation of Cellar Features - 1983

The third investigation, of the two features in the cellar of the extant house, was conducted by Dr. Grebinger in the winter of 1983-84. These were what appeared to be brick paving or footings in the north end of the main two-story part of the house, and a massive stone feature at the south wall of the south wing.

Prior architectural investigation of the south-wing cellar had identified early foundation walls that were lower and wider than the ca.-1837 foundation walls. This suggested that the extant, ca.-1837 south wing had been erected on the site of an earlier foundation here. Mortar analysis indicated that the stone feature likewise predated the construction of the house ca. 1837, being contemporaneous with the earlier walls.

Dr. Grebinger determined that the brickwork in the floor of the main-house cellar did indeed appear to be footings for the now-missing support for the ca.-1837 north chimney.¹⁶ The original function of the stone feature in the south-wing cellar was less clear. It was filled with two or more layers of fieldstone between which was sandy soil. Cultural debris including wire nails was found between the stones in the top layer only; no material culture was found in the soil comprising the second layer. This suggests that the stone feature was originally built as a solid mass, perhaps as a base for a fireplace for the pre-1837 structure here.

¹⁵ Hsu and Towle, p. 12.

¹⁶ Dr. Paul Grebinger, "Report to National Park Service, Archaeological Investigations, E.C. Stanton House, Seneca Falls," March 1983 (submitted August 1984).

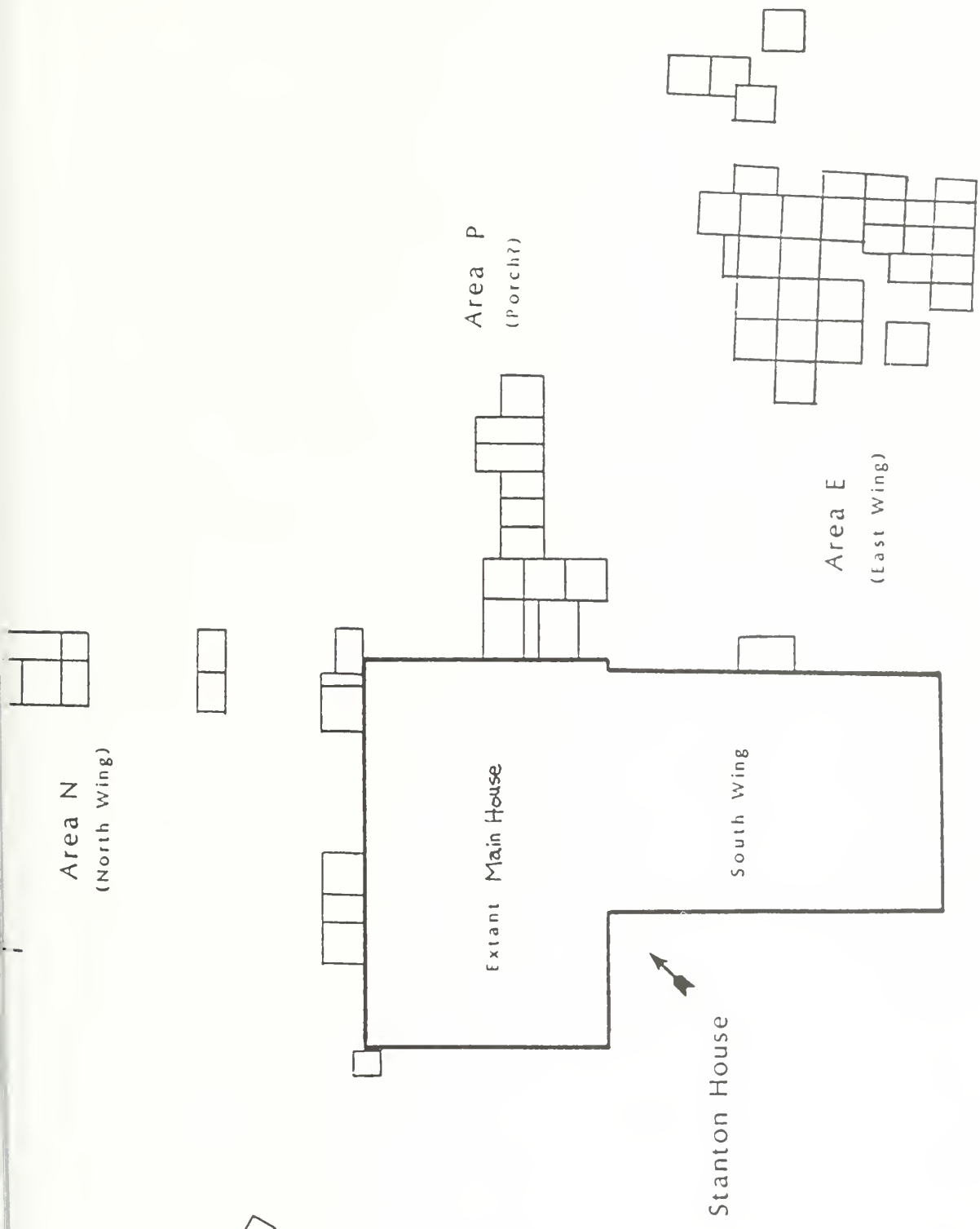

Figure 15. Map showing areas of archeological testing at the Stanton House, May 1983.

IV. DESCRIPTION OF PHYSICAL EVOLUTION

INTRODUCTION

The section that follows is a detailed description of the Stanton House's architectural evolution. This description integrates the research information obtained from the historical documents, the architectural investigations, and the archeological investigations. The history of the house has been divided into three periods: pre-Stanton (1798-1847), Stanton (1847-1862), and post-Stanton (1862-1982). Because the house was built before the Stantons' occupancy, an attempt has been made to decipher its early history. The most complete description, however, is provided for the years 1847 to 1862 when the Stanton family lived in Seneca Falls. Identification and documentation of post-Stanton alterations was also important, because these alterations would need to be "undone" in order to return the house to its Stanton-period appearance.

PRE-STANTON PERIOD (1798-1847)

Background

Architectural and archeological investigations indicate that the Stanton House had a complex history before the Stanton family moved into it in 1847. Two early buildings stood on the site prior to the Stanton House; mortar analysis of the remains of their foundations remains suggests that they dated to around the 1820s. These had disappeared by 1836, based on their absence on a map of that year. Shortly thereafter, at least two and perhaps three separate buildings were moved from other locations onto the lot and joined together. One of these, a two-story building, became the main house. Another was 1 1/2 stories; this became the south wing. The third may have been the so-called east wing, which was attached at an early date to the east side of the south wing. Alternatively, the east wing may have been built shortly after the other two sections were joined. This joining has been approximately dated 1837, based on the map of September 1836—which shows no buildings on the site—and a mortgage document dated December 1838 that mentions “the house and lot now occupied by William M. Bayard.”¹ The residence grew in size when another wing was built on the north side of the main house, after 1837 and but probably before 1842, when Bayard’s property was auctioned. It may have been part of major alterations in the Grecian style believed to have been done ca. 1840. These were the last major changes made before 1847.

Early Buildings

The physical evidence is clear that two early buildings once stood on the Stanton House site. Evidence of one of the buildings is found in the cellar of the present south wing. Here, early foundation walls that are lower than the circa-1837 foundation survive on the east and west sides. Also, at the south wall is a massive stone base of unknown original function. A mortar sample (M047) taken from this feature was found upon analysis to be a unique lime mortar not found in association with the circa-1837 foundation. This mortar is believed to be contemporary with the earlier building on the site and has been roughly dated to the 1820s. Archeological investigation of this feature by Dr. Paul Grebinger in 1983 determined that the interior is filled with two or more layers of fieldstone between which is sandy soil. Cultural debris including wire nails was found between the stones in the top layer of fieldstone only. No material culture was found embedded in the soil between the stones in the second layer. This suggests that the stone structure was originally built as a solid mass, perhaps as the base for an early fireplace on the first story.

Physical evidence of a second building, located to the east of the first building, was found by the archeologists in their excavation for the missing east wing. Remnants of this early building were located about 8 inches below existing grade and included stone foundation walls and interior brick paving that were originally thought to have been the east end of the missing east wing. Close analysis of these remnants, however, suggested otherwise. First, mortar analyzed from the east and west foundation walls (samples M076 and M078) were found to be similar in composition to the

¹ Mortgage Book R, Bayard Papers, Seneca Falls Historical Society.

early mortar in the previously described stone base below the south wing. Second, a ceramic shard found beneath the brick paving was determined by the archeologists to have been manufactured sometime before 1840. Third, the east wall of the east wing was measured to be 34 feet 3 1/2 inches from the existing east wall of the south wing. This conflicted with the circa-1900 photograph, from which measurements were taken that identified the length of the wing as being only 28 feet long.² It therefore appears that the Stanton House's east wing was built on the site of an earlier brick-floored structure.

As stated previously, these early buildings were not shown on the 1836 map, which suggests that they were no longer standing at that time. Alternatively, they could have been extant but in dilapidated condition, or utilitarian structures (such as barns, sheds, or warehouses) considered to be of minor importance. In any case, they were succeeded by the Stanton House. The two buildings may have been associated with the Lower Red Mills, a flouring mill built in 1807 and located only a short distance away to the northwest. Early occupation of the site is also suggested by two coins found in the yard by the archeologists in 1983: one dated 1813, the other dated 1835.

Origin of the South Wing

The present south wing was placed circa 1837 over the early foundation containing the stone base, as described previously. (The foundation was heightened as part of this work.) It seems most likely that the wing was salvaged from another site, and was not one of the two early buildings here. This is based on the 1836 map, which shows no structures in the vicinity, and on the mortar analysis for this report, which found no pre-1837 mortar in the cellar walls of the south wing. It is possible that further mortar sampling in that area might discover such early mortar; this could be compared to the mortar taken from the early stone base, to see if an association was probable between the south wing and the ca.-1820s foundation under it.

The wing had probably been a utilitarian building originally, based on two facts. First, the structural framing—in which the floor joists are placed 16 to 17 inches on center—had no provision for a stairway to the second story. Second, the interior was not plastered until it became part of the Stanton House. One early use is suggested by a pre-1837 doorway threshold preserved beneath a window in the first-story east wall. (That the window rather than the doorway is contemporary with the plastering is indicated by original lath nails found in the wood that frames the window opening.) No early exterior siding remains on the south wing, although what may be an early siding nail (N043) was found in the exterior framing of the wing's east elevation that was later covered by the east wing.

Origin of the Main House

There is little doubt that the main two-story part of the Stanton House was constructed elsewhere and moved to its present site where it was joined with the south wing. This is based on

² This measurement was obtained by using "reverse perspective"—a technique for determining linear dimensions from perspective dimensions in photographs.

several features. First, the brick support base for the north interior chimney was not keyed into the stone cellar foundation wall, as would most likely be the case if the house had been built in place. Second, the south elevation appears to have been exposed (i.e., lacking a wing) at one time; this would have been impossible on the present site, due to the existence of the old foundation located on the south side. Evidence includes: (1) fragments of large nails spaced for exterior board siding and now covered by the south wing; (2) paint on the south-elevation cornice (R131, R135) that was later covered by the south wing; and (3) interior plaster marks on a second-story center post, which indicate that the connecting doorway with the south wing was originally a window. Third, the location of the early interior stairway to the second story suggests that the original orientation of the house had the present south elevation as the facade.

Physical evidence—detailed later in this section—indicates that the house was originally built after 1822. It definitely existed on its present site by 1838, based on the Bayard mortgage document of that year. For ease of reference in this report, this range of dates has been shortened to circa 1830. The original location and owner of the house is not known.

Structural framing of the two-story house is heavy post-and-beam construction. Diagonal corner braces are numerous and stabilize the frame at the corner and center posts. Joists are spaced 16 inches on center. Cellar ceiling joists are oriented north-south in the present west end of the house and east-west in the east end; on the first and second stories, all ceiling joists are oriented east-west. Openings were provided in the framing for an interior chimney stack, a stairway to the cellar (although unused mortises in the center beam suggest that this was a change made during construction), a stairway to the second story, and doorways and windows, suggesting that the building's intended use was as a residence rather than a utilitarian structure. The roof is of gable design, with roof rafters mitered and nailed at the peak. Roof sheathing consists of crudely finished wide boards. Although no original roofing shingles remain, these were no doubt hand-rived wood shingles.

Some early exterior siding that appears to predate 1837 remains on the present north and west elevations of the main house. This is a board siding, rectangular in cross-section, measuring $6 \frac{1}{8}$ inches wide by seven-sixteenths of an inch thick. Board ends are butted, and the approximate width of board exposed to the weather was $4 \frac{3}{4}$ inches. These boards were attached with machine-cut nails. Original corner boards, one of which remains at the present northwest corner, had a decorative bead. Analysis of paint from the early north siding (P143, P230) and the south cornice (R131, R135) reveals the house was originally painted yellow with white trim.

As previously mentioned, what is now the south elevation of the main house appears to have been the front on its original site, based on the location of the early stairway to the second story (see figures 16-17). Evidence of this stairway, which was removed circa 1840, consists of structural framing details, patches in the second-story floorboards, and ceiling-lath patching in the first-story ceiling. Located in what is now Room 102, the stairway divided that space into an entry hall on one side and a small room on the other. A plaster wall screened the stairway from the adjacent room, but the stairway was open to the hallway, based on lath and plaster evidence on the framing for the stairway opening in the second story.

Also located on the first story was a large room, now Room 101. Later remodelings have destroyed all evidence of early interior doorways. However, common circulation patterns of the day suggest that two doorways connected this room with the rest of the house: one leading to the stair

hall, the other to the small room off the stair hall. Heat was provided by a fireplace that was located on an exterior wall. Framing for the interior chimney and hearth may be seen today in the first and second stories. Paint outlines on the existing floorboards indicate a closet was situated on the left side of the fireplace.

Relatively little evidence is left of the main house's original first-story finishes. All interior trim such as baseboards and architraves were replaced circa 1840. The old plaster was also replaced at this time, although the original circular-sawn lath held with early cut nails was retained. Assuming that the lath and plaster were installed soon after construction, the circular-sawn lath indicates the house was built sometime after 1822.³

The second story of the main house appears to have remained in an unfinished condition for a period of time following construction. Originally built as one large room, plain baseboards 6 1/2 to 6 3/4 inches high and plain window trim were installed but not painted. Nails holding this woodwork were machine-cut with round ends and shanks clasped for heading on the uncut (flat) edges. Two diagonal braces projected into the room from the side posts to the center ceiling beam. A fireplace and framing for a hearth were located at an exterior wall with an interior chimney, leaving little doubt that the intention was to eventually make this story habitable.

Later finishing of the second story appears to have been accompanied by a few alterations and additions. This finishing occurred before the south wing was appended and has been dated circa 1835, based on plaster marks that delineate a window opening at the south wall center post where an interior doorway was later added. At this time, the two diagonal braces projecting into the room were cut off, a section of baseboard was removed from the present southeast corner, and two windows were added in the present east wall. Two corner braces were cut to accommodate the new windows. Added were partition walls to create two chambers, a stair hall, two closets (one on either side of the fireplace), a 7-1/2 inch high baseboard in the stair hall, a hatch to the attic in the ceiling of the stair hall, doorway architraves with single bead detailing, four-panel doors, circular-sawn lath, and lime plaster. Nails holding the new woodwork differed from the original woodwork nails by having their shanks clasped for heading on their cut edges. The partition wall studs were crude wide planks that were reused during renovations in 1902-03. The woodwork on the second story was not painted until this time, based on the absence of paint on the circa-1830 baseboards where they were covered by the 1835 partition walls.

Moving and Reconstruction, Circa 1837

The moving and joining of the main two-story house and the south wing is believed to have occurred about 1837, based on documentary information described previously. (As will be explained shortly, the physical evidence suggests that the east wing was also constructed at this time.) Samuel and William Bayard had owned the property since December 1833.⁴ In 1836-37, Samuel Bayard

³ The circular saw came into general use in 1822 in nearby New England, according to J. Leander Bishop in *American Manufacturers from 1608 to 1860*, Vol. III (Philadelphia: Edward Young & Co., 1868).

⁴ Deed Book Z, p. 150.

purchased the former home of Colonel Mynderse.⁵ His brother William was living in the future Stanton House by 1838. It thus seems likely that William Bayard was responsible for creating the house later occupied by the Stantons.

The first work undertaken circa 1837 would have been site preparation. The existing old foundation appears to have been repointed at this time (M046) and heightened to receive the south wing. A cellar for the main house must have been excavated to the north of this foundation, with stone foundation walls laid with lime mortar (M048). The foundation for the east wing also appears to have been laid at this time, based on an analysis of the mortar type used in its construction. Above grade, the new foundation walls were made the same height for the main house, the south wing, and the east wing. Cut stones were used for the front (west) elevation except where the walls of the south wing were covered by the front porch. Direct access from the outside into the new main house cellar was made possible by a doorway located in the east wall of the main house foundation. The wood header and jambs for this doorway are still intact in the east cellar wall, and the archeologists uncovered the exterior stone retaining walls for this entrance in 1983.

The main two-story house appears to have been moved intact with lath and plaster, but without its chimney stack, which was later reconstructed in brick. This reconstructed chimney was supported in the cellar by brick footings that probably supported a brick arch. Although the chimney was removed in 1902-03, remnants of it were found during the architectural and archeological investigations. The brick footings were uncovered in 1983 three inches below the existing dirt floor, and fragments of bricks were found to have been preserved in the cavities of the north wall in Room 101. Other work done circa 1837 involved removing the siding from the south elevation of the main house, to facilitate the attachment here of the south wing. Lath and plaster evidence confirms that the original exterior doorway in the south elevation became an interior connecting doorway to the south wing. Similarly, on the second story, a south-elevation window was converted to a doorway to the wing. Lath nail evidence also suggests that a window in the second story of the north elevation was closed up at this time.

Much more work was done to the utilitarian building that became the south wing. Close examination of the post-and-beam frame revealed that the entire frame may have been taken apart and reassembled on the newly heightened foundation using a combination of old and new timbers. For example, the former exterior north wall of the wing (now abutting the main house) seems to have been completely reworked to make it an interior wall. The old wall studs were removed, and a new north-wall girt and corner posts were installed. That these timbers were new is evidenced by the fact that their north sides have no nail evidence of earlier exterior siding, no mortises for other beams, and no mortises for wall studs. No new north-wall studs were needed, because the wall of the main house took their place. As in the main house, a brick chimney was constructed, judging by extant structural framing and the photograph of circa 1900. Supporting it in the cellar was the old stone base that was investigated by Dr. Grebinger in 1983.

New board siding was installed on the south wing circa 1837, small sections of which were found in their original locations on the south and west elevations in 1982. These boards were both wider and thicker than the circa-1830 siding on the main house, measuring 6 3/4 inches wide by half an inch thick. The ends of these boards were also butted. Surface exposure to the weather was not regular, varying from 4 inches and 5 1/2 inches on the front (west) elevation to 4 1/2 inches and 4

⁵ Mrs. S.A. Wetmore, "The Bayard Family," *Seneca Falls Historical Society Papers, 1911-12*, p. 66.

3/4 inches on the south elevation. Some board siding removed from the south elevation of the main house may also have been used on the south wing, although none was specifically identified during the architectural investigation.

The main entrance to the newly created house was in the west elevation of the south wing. Although extensively altered in 1902-03, this doorway is seen in the exterior photograph of circa 1900 to have been Greek Revival in style, with sidelights. Pieces of this doorway that were removed and reused during the remodeling of 1902-03 (R094; R130; R151a,b) further define it as having two pilasters on either side of the doorway and a drip-cap header.

The old window sashes, also removed in 1902-03, are shown in the photograph of circa 1900. In the south wing, these sashes had nine-over-six lights (panes) in the west elevation, and six-over-six lights in the south elevation. Also fitted with nine-over-six sashes were the second-story windows of the main house. That both types of sashes were extant circa 1837 is confirmed by the placement of cutouts for early flat metal sash springs in the old window frames of the main house and south wing, discovered during the architectural investigation in 1982.

A new porch was built onto the front elevation of the south wing when it was joined to the main house. It seems clear that the porch was constructed at this time: rubble stone was used for the wing's west foundation wall, instead of the cut stones that would have been used if the foundation wall was not going to be hidden by the porch. The porch was removed in 1902-03, but its appearance is documented by the circa-1900 photograph. It was open, with a plank floor and a shed roof supported by two Doric columns. A remnant of a gutter leader can be seen at the southeast corner of the cornice. The slope of the porch roof is less than that of the adjacent south wing roof, which is further proof that the porch was not part of the pre-1837 structure.

Interior finishing work was also undertaken in the south wing at this time. Installed were partition walls, a steep staircase to the second story, woodwork, and lath and plaster. Partition walls divided the first-story space into three separate rooms, and the second story into two rooms. In addition, partition walls were installed on either side of the new fireplace on the first story (Room 104) to create a stairway space on the left side and a closet on the right side. Although all of these partition walls were removed in 1902-03, evidence such as paint lines on the floorboards and plaster marks helped to identify their locations. Even the wall studs were found to have been reused in 1902-03. These studs were wide planks similar to those used in the main house circa 1830 and circa 1835.

The stairway to the second story of the south wing was built by first installing the partition wall to the east side of the south-wall fireplace and then cutting the existing second-floor joists. The partition thus became a bearing wall, carrying the weight of the floor above. That this was the case is indicated by the pressure marks left in the floorboards at the former location of the wall. This staircase by necessity must have been very steep. Removed in 1902-03, all that remains of the stairway are the pressure marks in the floor, the sawn-off floor joists, and a trim fragment attached to an adjacent second-story floorboard that had been reused elsewhere in 1902-03 (R190).

The interior of this former utilitarian building was further domesticated by the addition of baseboards, doorway and window architraves, doors, and a fireplace mantel. Of this woodwork, two types were identified: stylized and plain. Rooms with stylized woodwork were characterized by doorway and window architraves with attached Grecian moldings, and baseboards (6 1/4 to 6 3/4

inches high) with a bead along the top edge. Interior doors in stylized rooms had four panels with Norfolk latches (based on R065), and one stylized room (Room 104) had a fireplace mantel (based on R065). Rooms with plain woodwork were characterized by plain-board doorway and window architraves, and plain-board baseboards (5 3/4 to 6 inches high). Determining which type of woodwork had been used in each of the five south-wing rooms was complicated by the fact that all of the interior woodwork had been removed in 1902-03, except for one window architrave in Room 104. Fortunately, much of the removed woodwork had been reused in various locations in the house. Returning these reused woodwork pieces to their original locations was accomplished by comparing paint layers, recording the painted outlines of doorway-architrave moldings on floorboards, and aligning nail holes. Thus, circa-1837 woodwork was identified for the following rooms: Room 103, west end - stylized; Room 103, east end - plain; Room 104 - stylized; Room 203 - unknown (although most likely plain); Room 204 - plain. Large nails used to attach the woodwork circa 1837 were machine-cut with round ends and shanks clasped for heading on the uncut (flat) edges.

All of the first- and second-story rooms in the south wing were plastered circa 1837. Lath used at this time was a crude split type, rather than sawn. Lath nails were small (about one inch long), machine-cut, with round points and shanks clasped for heading on their cut edges. Plaster was a lime-sand mixture with hair binder, composed of about one part lime to two parts brown-color sand. Most of this plaster was removed in 1902-03, with the only evidence of it remaining in 1982 being the characteristic lath nails and plaster marks on the wall studs, ceiling joists, and roof girts. Lath with attached plaster survived only on the first story behind one later partition wall (M024a), and on the second story behind the circa 1902-03 bathroom wainscot (M044). Loose plaster was also identified to have fallen into the exterior wall cavities of Rooms 103 and 104 (M041 and M042).

Painted finishes circa 1837 were relatively austere for both the main house and the south wing, based on the paint analysis. Exterior siding and trim were white (white lead in oil), a typical Greek Revival treatment. Interior plaster walls received a water paint such as calcimine, and the woodwork was finished with oil paint. A summary of the interior finishes, to the extent known, is as follows:

<u>Room</u>	<u>Floor</u>	<u>Plaster</u>	<u>Woodwork</u>
101	gray	?	?
102	?	?	?
103 (east)	gray	cream	cream
103 (west)	gray	?	cream
104	yellow	blue	gray
201	?	?	dark gray
202	?	?	dark gray
203	?	white	?
204	?	white	dark gray

The East Wing

Unlike the extant main house and the south wing, little is known about the east wing because it was removed in 1902-03. The only information available comes from the photograph of circa 1900 that shows just the south elevation, from architectural fragments found during the architectural investigation, and from archeological work done in 1980 and 1983.

The construction date of the east wing is a matter of some controversy, because the evidence is somewhat contradictory. The most compelling evidence suggests that it was contemporaneous with the joining of the main house and the south wing circa 1837. Documentary support for this theory is found in the circa-1900 photograph, which shows: (1) the house's board siding running continuously from the south wing's south elevation onto the east wing, with no visible break where the two wings join; and (2) the east wing's first-story window sashes as being identical in size and style (nine-over-six lights) to those seen in the main house and the south wing. The physical evidence may be similarly interpreted. No circa-1837 siding nails were found in the exterior east wall of the extant south wing in the vicinity of the missing east wing, as would be expected had the south wing been built first. Doorway-architrave fragments (R053a,b,c, and R118) reused in 1902-03 and identified by the paint analysis as having come from the east wing are similar to those installed in the south wing circa 1837. Most significantly, several mortar samples recovered from the east wing's stone foundation (M071, M075, M077, M081, and M080) were found upon analysis to be similar in composition to the circa-1837 mortar in the stone foundations of the main house and the south wing.

Evidence for a later construction date for the east wing are three architectural features. First, east-wing lath and plaster preserved on the east elevation of the south wing at the second-story level differs from the circa-1837 lath and plaster in the south wing. The east wing lath is circular sawn versus split, lath nails are longer, and the proportion of lime to sand in the plaster is higher. Second, while the doorway-architrave fragments are similar in style to those in the south wing, the east-wing architrave differs by being about an eighth of an inch wider, and by having door hinges (two per door) that are held with three instead of four screws per leaf, as found in the south wing. Third, there is no evidence in the east foundation wall of the south wing to indicate that the foundation of the east wing had ever been bonded to it.

All three features, however, can be explained to accommodate a construction date of circa 1837. The second-story interior of the east wing may have been plastered sometime after the wing was constructed, which would explain the different lath, nails, and plaster. The architrave width and hinge type are not necessarily indicative of a time lapse; variations in these types of elements often occurred in less-formal areas of a house. Finally, the foundation of the south wing would probably have needed repairing when the east wing was removed, which might have obliterated any evidence of the east-wing foundation. Therefore, unless more conclusive evidence is found for a later construction date, a date of circa 1837 will be assigned to the east wing.

The following description of the east wing is based on the earliest exterior photograph of the house and the archeological evidence. The wing measured approximately 28 feet long by 14 feet 6 inches wide. It appears to have been built on the site of an earlier brick-floored building of approximately the same width. The wing was 1 1/2 stories high with a gable roof, two stories of living space, and no cellar. The foundation was stone, as was the chimney support at the east end

of the wing. The siding consisted of boards installed horizontally with the same exposure as the board siding in the south end of the south wing. Four openings were located in the south elevation of the wing. In the first story were two doorways, each fitted with a four-panel door, and one large window with nine-over-six sashes and window shutters. In the second story was a smaller window above the large window. It, too, was fitted with shutters that were closed at the time the photograph was taken, such that the sashes cannot be seen. The chimney stack above the roof was brick.

The number and usage of rooms in the east wing is not known, due to the lack of both documentary and physical evidence. Based on Mrs. Stanton's stated preference for a sunny, airy kitchen (see Appendix G), the first story of the east wing may have contained the kitchen and associated rooms such as the pantry and the dining room. Bedrooms may have occupied the second story. Some space must have been devoted to a stairway between the first and second stories, since there was no doorway connecting the second stories of the south and east wings.

The North Wing

The existence of a wing formerly attached to the north side of the main house was first disclosed by lath and plaster marks found on the exterior wall studs of the main house. Closer examination of the extant house also revealed: (1) a semi-circular cutout in a wall stud adjacent to the former main house chimney that was thought to have been for a stove pipe; (2) a missing diagonal brace removed to accommodate a connecting doorway; and (3) roof flashing nails in siding not removed from original locations, indicating that the wing was 1 1/2 stories tall. Archeological excavations in 1983 found that the stone foundation of the wing survives below existing grade, and measures 24 feet 1 inch long by 17 feet 5 inches wide. Comparison of these dimensions with the extant south wing is of interest because they are almost identical, the south wing measuring 24 feet long by 17 feet 3 inches wide, according to the drawings of the Historic American Buildings Survey. It therefore appears that in addition to expanding the size of the house, the north wing achieved a symmetrical elevation in keeping with the Greek Revival style. It is likely that a porch was also located on the front side of the north wing; this may one day be confirmed by additional archeological work.

It is clear that the north wing was added sometime after the main house, south wing, and east wing were joined circa 1837, based on foundation evidence, construction techniques, and lath-nail type. First, the north-wing foundation is butted to, not bonded with, the main-house foundation. Mortar from the north-wing foundation (M066) is a lime and sand composition different from other foundation mortar that has been identified as circa 1837. Second, when the south wing was joined to the main house, extant circa-1830 siding was removed from the main house where the wing covered it at both the first and second story levels. When the north wing was appended, however, the siding at the first story only was removed, based on the lath and plaster marks and the old siding that remained in 1982. Third, the lath nails associated with the north wing, while also machine-cut, are longer than the nails in the main house, the south wing, and the east wing.

Although the evidence is less clear in this respect, the wing was probably built before 1842, when the Bayards lost the house in an auction. After that date, the house was vacant until the

Stantons moved in.⁶ Furthermore, there is no documentation that the Stantons built the north wing. Therefore, this report has assigned a construction date of circa 1839. The north wing was removed circa 1864 when the property was subdivided into six lots.

Later Interior Decorating

Work at the house on Washington Street was not restricted to the building of a new wing between the years of circa 1837 and 1840. Decorative "finishing" work continued in the original main house and the south wing. The most information about this work has survived in Rooms 103 and 104. What was then a small back room (now Room 103) appears to have changed little, receiving only additional coats of white calcimine wall paint. Room 104, on the other hand, was redecorated many times, perhaps because it was a principal room and received much use. First, the blue-painted walls were painted over with a white calcimine paint. Later, the walls were hung with a wallpaper with a grape design commonly known as "trophies of the vineyard." This paper, printed in black on a mustard-yellow background, would have been appropriate in a mid-19th century dining room. The paper stock of the wallpaper is machine-made (i.e., lacking horizontal seams as found in handmade paper) thus dating it after 1835-38.⁷ Also at this time, the woodwork was decoratively painted in imitation of a wood grain, a technique known as "graining." Whether because of damage or because the design was disliked, the grape-design wallpaper was soon painted over with a light blue-tinted oil paint.

Remodeling, Circa 1840

Following construction of the north wing, alterations and repairs were made to the main house and the south wing. This work has been approximately dated 1840 based on the style of the new woodwork trim installed in Rooms 101 and 102, the wallpaper hung at this time, and the documentary evidence.

The new doorway and window architraves in Rooms 101-102 were a Grecian style popularized by Minard Lafever in his book *The Beauties of Modern Architecture*. This book was first published in 1835 and reprinted in 1839, 1849, and 1855. It is therefore possible to say with a fair degree of accuracy that the architraves were installed after 1835 and before 1860. The date could be further pinpointed by using the wallpaper found in association with the changes. These papers, found in Rooms 102, 103, and 104, are composed of a machine-made paper stock and therefore were made after 1835-38.⁸ More particularly, the foliate-design paper in Room 102 has been documented at the Martin Van Buren National Historic Site in Kinderhook, New York, as being

⁶ Elizabeth Cady Stanton, *Eighty Years and More: Reminiscences 1815-1897* (New York: Schocken Books, 1971), p. 144.

⁷ Catherine Lynn, *Wallpaper in America: From the Seventeenth Century to World War I* (New York: W.W. Norton & Co., Inc., 1980), p. 41; and Bishop, pp. 306, 363.

⁸ Lynn, p. 41.

a circa-1840 paper hung in 1843.⁹ Additional support for the circa-1840 date is provided by the documented history of the house. The alterations made at this time seem to be more extensive than those supervised in 1847 by Elizabeth Cady Stanton when she acquired the house. Stanton later described building only a new kitchen and wood house, and employing carpenters, painters, and paperhangers. She recalled that all work was completed in one month. Assuming, therefore, that the work pre-dates 1847, it was most likely done by William M. Bayard before his house was auctioned in December 1842.

The lath nails found in association with the circa-1840 alterations are a distinctive type, having round ends similar to earlier nails, and shanks clasped for heading on the uncut (flat) edges. The woodwork nails, on the other hand, did not differ from the earlier nails, having round ends and shanks clasped for heading on the uncut (flat) edges similar to those used circa 1830 and circa 1837. Therefore, the interior lath nails rather than the trim nails were used during the architectural investigation as dating devices. It was discovered that much of the work done circa 1840 had survived, either intact or in pieces, in 1982.

In the main house, interior work was undertaken circa 1840 on both the first and second stories. On the first story, a double parlor was created by removing the stairway to the second story and the stair-hall partition wall, and installing an 8-foot-wide doorway between Rooms 101 and 102. As previously mentioned, the doorway and window architraves in the new parlor were in the Grecian style; these were found in 1982 to have survived in Room 101 in a mixture of original and reused locations. Both rooms received smoothly finished plaster applied to the old and some new lath on the walls and ceilings. A foliate-design paper (fragments of which were found in Room 102) was hung on the walls, the ceiling was painted with a white calcimine, and the woodwork trim and plaster panels below the three windows in Room 101 were painted in imitation of wood grain. Lath nails closing the former stairwell opening in the ceiling of Room 102 were identified as being the circa-1840 type. The large doorway between the two rooms was defined in 1982 by the locations of the circa-1840 baseboards that survived on the partition wall, and by the modern lath nails that were later used to close the opening. More obscure architectural evidence in Room 102 was used to identify two French doorways in the west wall and an interior doorway in the south wall. All that remained in 1982 of the French doorways were two cut-outs for thresholds in the adjacent east floorboard, delineations in the circa-1840 plaster for two openings of window height but doorway width, and a reused header architrave (R030b) with a center mortise for French door hardware. Identification of the interior doorway location at the south wall of Room 102 was similarly based on the delineation of a doorway opening in the circa-1840 plaster, and on the finding of the reused left side architrave (R030a).

Alterations on the second story of the main house involved removing the stairway to the first story and the stair-hall partition wall, and creating two chambers. One doorway connected the two chambers in the north-south partition wall. This was determined based on the number of doorway architraves from Rooms 201 and 202 that were found to have been reused in 1902-03. The architrave at the south doorway to the south wing appears to have been reworked at this time, with an architrave from elsewhere in the house installed here. Similar to the first story, both chambers were replastered. The walls of both rooms were painted with a yellow-tinted calcimine, the ceilings with a white calcimine paint, and the woodwork with a cream/white oil paint except for the floors, which were painted yellow.

⁹ Andrea M. Gilmore, "Lindenwald Wallpapers" (typescript draft, NPS, February 1980).

Removal of the main-house stairway circa 1840 necessitated the installation of a new stairway somewhere in the house. Although missing in 1982, the architectural investigation located the circa-1840 stairway in the northeast corner of the south wing. Confirmation that the new stairway was built at the same time as the other alterations in the main house was provided by the lath nails found in association with the new stair opening in the second-story joists. Further proof was provided by the first painted finish on the new stairway woodwork that was identified by the paint analysis to be the same grained finish applied in Rooms 101 and 102 circa 1840. Building of the staircase involved first removing the circa-1837 north-south partition wall on the first story and then removing the ceiling where the stairway opening would be. The stairway that was installed was of a curved design, with a small closet beneath the upper risers. On the second story in the new stair hall, new and reused woodwork with a single-bead detail was installed, probably replacing the same type of circa-1837 plain board woodwork found in Room 204. Also installed was a new railing at the perimeter of the stairwell. The plaster walls were finished both upstairs and downstairs with a wallpaper printed with a neoclassical urn pattern in colors of black, gray, and white on a background of blue.¹⁰ Downstairs, the woodwork was grained as previously described; upstairs, the woodwork was painted with the same cream/white oil paint as Rooms 201 and 202.

Reconstruction of the circa-1840 curved staircase was a challenge since it had been replaced by another staircase in 1902-03. Determination of its appearance was accomplished by carefully studying paint outlines on the original floorboards, mortises in the floorboards and joists for newel and railing posts, and reused fragments such as balusters, railings, posts, risers, and landing floorboards. All of the woodwork in the upper stair hall had been removed, and only some pieces had been reused in 1902-03. These were identified and returned to their original locations based on associated wallpaper fragments and paint. The largest pieces of circa-1840 wallpaper were found in the south wall cavities and discarded under the front porch.

The only work that appears to have been done in Room 104 circa 1840 was to enlarge the doorway to the east wing, hang new wallpaper, and grain the woodwork. The only remaining evidence of the doorway woodwork are two pieces of architraves that had been removed and reused in 1902-03: R019 and R030c. These pieces are lacking the early paint layers of Room 104 and are wider than the circa-1837 doorway architraves. Wallpaper identified as having been hung at this time is a marble-like pattern in colors of blue and red on a plain background. The paint analysis found that the woodwork had been grained as in the other first-story rooms (Rooms 101, 102, and 103), except that the pink-color base coat was darker, with distinct red pigment particles.

Only painting appears to have been done in Room 204 circa 1840. The plaster walls were finished with a white calcimine paint, based on loose plaster fragments found to have fallen in the wall cavities of Room 104. The woodwork was painted with a cream/white oil paint as in the other second-story rooms. This is based on the paint analysis of the baseboards, which had been removed and reused in 1902-03.

¹⁰ This wallpaper is commercially available as a historical reproduction in 1983. It is manufactured by Katzenback and Warren, Inc., as part of their "Williamsburg" line. The pattern is called "Windham," which is described as "a reproduction of a French antique paper of the late 18th or early 19th century." The historic document color is described as "gray."

Work on the exterior of the house circa 1840 has been conjectured based on evidence for two French doorways in the east wall of Room 102. These doorways no doubt opened onto a back porch on the east elevation of the main house. A porch in this location, however, would have covered over the circa-1837 entrance to the cellar in the east foundation wall. Therefore, assuming that a porch was built at this time, the exterior cellar doorway must have been closed off, thus dating the existing stone and mortar (M065) infill at the doorway opening as circa 1840. Archeological work in 1983 failed to find any evidence of foundation walls for a porch or steps. This may be explained by either the misplacement of the test pits or the fact that the foundation was simply composed of stones placed above grade.

Redecorating, Circa 1841-1846

Redecorating work done after circa 1840 and before the Stantons' occupancy in 1847 was identified in Rooms 201 and 202 only. In both, the circa-1840 yellow calcimine paint was painted over with a vibrant green-colored calcimine. Sometime thereafter, the walls in Rooms 201 were painted white. A different treatment was chosen for Room 202, where the walls were covered with a wallpaper having a geometric design in colors of red and brown. While this may seem to be an inordinate number of finishes for such a short time period, it should be remembered that water-soluble paints such as calcimine were relatively inexpensive and impermanent.

STANTON PERIOD (1847-1862)

Background

Identifying the work supervised by Elizabeth Cady Stanton in 1847 proved a difficult task because so much of the house as she knew it (i.e., the east and north wings) is now gone. Of the “new kitchen, wood house, and several porches” mentioned in the writings of Mrs. Stanton and her daughter, no conclusive evidence was found in 1982. More luck, on the other hand, was had in determining the decorative finishing work in the extant main house and the south wing by the “painters” and “paperhangers.” Also, although not recorded by Mrs. Stanton, new window sash springs were found that may have been installed in 1847 or sometime before 1862.

The section that follows is an attempt to provide a description of the Stanton House and its site as they existed between the years of 1847 and 1862. The source or evidence used—such as written documentation, archeology, or architectural information—is noted for each feature. Although specific documentary sources are not cited here, these may be found in the “Historical Background” section of this report. Where possible, architectural fabric has been dated. Materials in their Stanton-period locations are so noted. Materials removed from their original locations and reused elsewhere are denoted by their reuse catalog number (e.g., R001; see also see Appendix F).

Exterior Appearance

Site

Elizabeth Cady Stanton’s deed describes the site as encompassing about two acres. It was bounded on its west side by Washington Street and some hedge, on its north side by Seneca Street, and on its east and south sides by a board fence. Writings by the Stanton family described grass lawns, large vegetable gardens, and fruit and evergreen trees. These same writings also made note of benches in the garden and play equipment for the children, including swings, bars, and ladders. Outbuildings mentioned in Mrs. Stanton’s autobiography included a barn, a wood house, and a smoke house. A well or wells were the most likely source of water, one of which was discovered by the archeologists in the east yard in 1983. Archeology also uncovered what appeared to be brick-paved walkways that may have existed during the Stanton years.

General Description

The house was later described by family members as a “mansion,” a long, rambling house with wings and porches. The findings of the architectural investigation suggest there was a main two-story house and three one-and-one-half story wings: a north wing, a south wing, and an east wing. There were probably at least three porches: one on the west side of the south wing, another on the west side of the north wing, and a third on the east side of the main house. The architectural style was vernacular Greek Revival, based on the photograph of circa 1900 and remaining architectural fabric.

Walls

Foundation

The foundation walls were a combination of cut and rubble limestone. This is based on the extant walls of the main house and the south wing, and on the remnant walls of the missing east and north wings that survive below existing grade.

Siding

The house was sided with horizontal board siding that was painted white. Some of this early siding was found in 1982 beneath later shingle siding on the main house and south wing. The oldest siding, circa 1830, is believed to have been on the main house. These boards measure 6 1/8 inches wide by 7/16 inches thick with 4 3/4 inches exposed to the weather. The siding on the south wing was later, having been most likely installed circa 1837 when the wing was joined to the main house. These boards measure 6 3/4 inches wide by half an inch thick. Exposure to the weather varied between 4 inches to 5 1/2 inches on the west elevation, and 4 1/2 inches to 4 3/4 inches on the south elevation. No measurements are available for the siding of the missing east and north wings.

The corner boards of the main house and the south wing were embellished with a single bead molding. This is based on one early surviving board on the main house (at the northwest corner), and a reused fragment of board from the south wing (R186). No information is available on the corner boards of the missing east and north wings.

Skirt boards, also known as the water table, measured approximately 3 3/4 inches wide by 1 1/8 inches thick, based on the earliest extant board on the west elevation of the south wing. Detached skirt-board fragments were also identified during the architectural investigation and were cataloged with numbers "R143" through "R149." These boards are distinguished by having a top beveled edge.

Doorways

The number of exterior doorways that existed during Stanton's time is not known, since two of the wings are missing. Although Mrs. Stanton herself joked about adding doorways and windows to the house in Seneca Falls, no existing openings were identified as having been installed by her. Only one historic doorway survived until 1982, and that in drastically altered condition. Those early doorways that would have existed in Stanton's day and for which information is available are described below.

A front doorway was located in the west elevation of the south wing. This was in the Greek Revival style with sidelights and a three-panel door, according to the photograph of circa 1900. Other details included side pilasters and a top molded hood, based on reuse fragments R094, R130, and R151a and b. This doorway opening survived in 1982 but without its door, woodwork trim, or sidelights.

Two doorways entered the south elevation of the east wing, as recorded by the photograph of circa 1900. Each had plain architraves and a four-panel door. One was fitted with a shed-roof hood, although this may have been a post-Stanton addition.

Two more doorways were in the east elevation of the main house, based on physical evidence discovered during the architectural investigation of Room 102. These doorways appear to have been fitted with French doors, based on a cutout in the interior trim for French-door hardware. They also must have opened onto a back porch, based on the height of the openings above grade.

No information is available about doorways in the north wing. However, it is likely that the wing's front (west) elevation had one doorway similar in location and style to the west-elevation doorway in the south wing. This is based on the previously noted symmetrical relationship between the two wings.

Windows

As with the doorways, no window openings were specifically identified as having been installed by Mrs. Stanton. Several historic window openings survive in their original locations in both the main house and the south wing. The window sashes and shutters, however, were all replaced in 1902-03. Our knowledge of these features is provided by the exterior photograph of circa 1900 and the physical evidence.

The cellar windows were small, and each appears to have been fitted with eight vertical wood bars. These bars may be seen faintly in the photograph of circa 1900 in the southwest window of the main house. Physical remnants of these bars were also found in the window frame of the east window in the south wing. The function of the bars was probably to keep large animals out of the cellar while at the same time admitting air. No documentary or physical evidence was found for the cellar window sashes.

Two types of window sashes are shown in the circa-1900 photograph in the first and second stories: nine panes over six panes, and six panes over six panes. The nine-over-six sashes are visible in the windows of the main house's west elevation, the south wing's west elevation, and the east wing's south elevation. The six-over-six sashes are in the windows of the south wing's south elevation. Although not seen in the photograph, the size of the extant historic window frames in the back (east) elevation of both the main house and the south wing suggests that these windows were fitted with nine-over-six sashes. Of the historic sashes, only one pair survived in 1982, because it had been reused in the new bathroom in 1902-03. This pair was six-over-six in style; it and its frame were cataloged as R013 and R014.

Window shutters hung at the first- and second-story windows. The shutters seen in the circa-1900 photograph are louvered and presumed to have been early. Close study of the photograph revealed that the shutter hardware consisted of two hinges per leaf, a fastener attached to the bottom rail of each shutter leaf, and a shutter catch mounted to the board siding. It was found upon examination of the house that painted outlines of the former wall-mounted catches were located on either side of the south window in the west elevation of the south wing. These outlines measured 1 1/4 inches wide by 1 1/8 inches high. Three holes within the outlines indicate that the wall catches had been attached with three screws each. Also discovered beneath the later (circa 1902-03) sill-

mounted shutter catches in the same window were the remnants of earlier sill catches. These were metal rods, one-quarter of an inch in diameter, that had been sawn off for the new hardware. Their original configuration was most likely bent so as to receive the shutter fasteners. The physical evidence indicates that there were two rods per sill, one for each shutter leaf. Determining what the shutter fasteners themselves looked like was accomplished by looking at existing circa-1830s hardware in the Seneca Falls area and by looking through the Russell and Erwin hardware catalog of 1865.¹¹ Three fasteners, all on page 148 of the catalog, were identified as likely designs. These included "Mackrell's Pat. Iron Oval Blind and Shutter Fastenings," Van Sand's Pat. Wrought Iron Blind or Shutter Fastenings," and "Merriman's Blind Fastenings."

Also common to all the windows in the first and second stories were interior window sash springs that functioned to hold the bottom window sashes in an open position. Evidence of two types of springs was observed on the interior sides of the window frames in both the main house and the south wing. Of these two springs, the second, which replaced an earlier flat metal spring, may have been installed by the Stantons. The second spring was a type patented by Marcus Merriman, Sr., in April 1835.¹² It was still available in 1865, based on its inclusion in the Russell and Erwin hardware catalog of that date.¹³ The Stanton House springs, however, were probably installed before 1860 because they were held in place with blunt-end screws.¹⁴ Mrs. Stanton's documented advocacy of fresh air and ventilation lends further credence to the theory that the Merriman springs are Stanton-vintage.

Roofs, Cornices, and Gutters

Roofs

The roofs of the main two-story house and the three attached wings were all of gable shape. Porch roofs appear to have been a shed design. Extant old sheathing boards on the main house and the south wing are wide and rough-cut. Evidence of two periods of roof shingles only was discovered on a portion of the main house's roof that had been covered over by the heightened south-wing roof in 1902-03. Assuming that the first shingles were installed on the house when it was first constructed circa 1830, it is possible that the second shingles were installed under the direction of Elizabeth Cady Stanton as part of the repairs made to the house in 1847. Remnants of these shingles indicate that they were hand-rived, a type generally not found after about 1850, and held with machine-cut shear-ended nails, which are usually not found before 1840. Shingle exposure to the

¹¹ Both wood and brick houses were examined by Stephen Spaulding in Seneca Falls, Waterloo, Geneva, Trumansburg, and Canoga.

¹² Marcus Merriman, Sr., "Merriman's Window Spring & Bolt," April 1835 (*Early Unnumbered U.S. Patents 1790-1836*).

¹³ Russell & Erwin Co., *Illustrated Catalog of American Hardware* (1865), p. 149.

¹⁴ Raymond and Marguerite Yates, *A Guide to Victorian Antiques* (New York: Harper & Bros., 1949), p. 34. Pointed or "gimlet" screws were first introduced in 1847, although it is believed that the existing supply of blunt-end screws lasted a number of years.

weather was about 6 inches. The exposed surfaces were observed to be extremely worn, as would be expected of a roof that was more than 50 years old.

Cornice and Gutters

None of the old cornice and gutters remained on the house in 1982. Reconstruction of their appearance during Stanton's time was therefore based on a close study of the exterior photograph of circa 1900 and cornice fragments that were found to have been reused in 1902-03. The fragments included R024, R025, R128, R129, R131-142, R150, R152, and R187-89. That gutters had in fact been on the house during Stanton's time was determined based on the Stanton family correspondence. Exactly where these gutters had been located, however, was difficult to ascertain. The photographic evidence indicates that there was a built-in gutter on the south wing's front porch, based on a downspout remnant at the southwest corner. Reconstruction of the cornice fragments suggested that gutters were not incorporated in the cornices of the main house, the south wing, or the east wing.

Chimneys

Chimneys were numerous during the Stantons' time. The main house, the south wing, the east wing, and the north wing each had its own chimney, making a total of four chimneys. These were constructed of brick, according to the photograph of circa 1900, brick fragments found in the contiguous wall cavities, whole bricks found in the basement, and the findings of the archeologists. The north wing's chimney was no doubt removed at the same time as the wing, circa 1864. The three remaining chimneys were removed during the remodeling of 1902-03. Bricks from these chimneys appear to have been reused in the south wing's basement, based on dark charring on many of the bricks. These were used to build a new stairway retaining wall to the new east wing and a well/cistern on the east side of the basement. The bricks are red-orange in color and measure 7 3/4 inches long by 3 5/8 inches wide by 2 1/2 inches high.

Finishes

The exterior paint color of the Stantons' house appears to have been Greek Revival white in 1847, based on the paint analysis. Features painted white include the board siding, the corner boards, the cornice, the doorway and window architraves and sills, and the porch columns. It is not known how the doors, the window sashes, or the shutters were painted, since there are no remnants of these features. Typical Greek Revival colors would have been green shutters and black window sashes and doors. These colors were found in a paint analysis of the 1833 Lewis Hayden House on Beacon Hill in Boston, Massachusetts, which identified the circa 1849-60s exterior window shutters as having been painted green (color-matched to Munsell 2.5 BG 3/4) and the window sashes and front door as having been painted black.¹⁵

¹⁵ National Park Service memorandum dated August 10, 1983.

Interior Appearance

Finishes

As with the exterior, no interior finishes in the extant house could be unequivocally attributed to the Stantons. Identification of interior Stanton-period wallpaper and paint finishes was therefore based on datable stylistic characteristics of the wallpaper design and the contextual locations of the paint layers. It was thus determined that all rooms in the main house and the south wing, except for Room 204, had been wallpapered during the years 1847-62. In fact, it appears that the rooms were papered twice during the Stantons' 15-year occupancy of the house. All of the wallpapers from this period were found to be composed of rag (versus wood pulp) fibers. The walls in Room 204, along with the ceilings in all the rooms, continued to be painted with white water-soluble (calcimine) paints. Woodwork was either grained or painted with lead-base white oil paint. Two types of oak graining were identified by the paint analysis. A refined oak-style grain applied over a yellow base coat was found in the double parlor, Rooms 101-102. A quartered oak-style grain applied over a base coat of cream was located in the room off the stair hall, Room 104. Plain white-painted woodwork was in the stair hall (Room 103) and in all the second-story rooms (Rooms 201, 202, 203, and 204). The reason the first-story stair hall was not grained may have been to brighten this relatively dark room, naturally lighted by only the front doorway sidelights and the east-wall window, which was partly covered by the curved stairway.

Kitchen Location

The exact location of the kitchen during the Stantons' occupancy is not known. In recent years, it has been conjectured that the kitchen was in the former east wing.¹⁶ While this theory may have arisen due to the fact that the modern kitchen wing replaced the east wing in 1902-03, it is supported by documentary and physical evidence. The east wing would have had a broad southern exposure, reflecting Mrs. Stanton's later recommendation to make "the sunny side of [a] house into a large airy kitchen."¹⁷ Also, there is no evidence that a kitchen ever existed in the main house or the south wing. While it is possible that there was a kitchen in the north wing, it is not likely given its small size and relative placement. Mrs. Stanton recalled in her autobiography that she had "built a new kitchen" upon moving to Seneca Falls. Exactly what she meant by a "new" kitchen is unclear, since this may refer to either building a new addition or remodeling an existing structure. The building of a complete new kitchen wing seems unlikely, since both the east and north wings appear to have been constructed before 1847, as explained in the previous section. Any evidence of remodeling was unfortunately destroyed along with the wing.

¹⁶ Paul Grebinger and Corinne Guntzel, "The Domestic Economy of Elizabeth Cady Stanton: Her House and Its Artifacts" (typescript, 1981).

¹⁷ Elizabeth Cady Stanton, "Home Life" (ca.-1880 lyceum speech, manuscript, Rutgers University), p. 5.

Cellar

Location and Size

A full walk-in cellar exists today in what remains of the Stanton House: the main house and the south wing. The main house's cellar measures 22 feet 9 inches long by 14 feet 4 inches wide, and the south wing's cellar 21 feet 1 inch long by 15 feet 3 inches wide. A separate cellar most likely existed beneath the north wing, according to the findings of the archeological excavation in 1983. The east wing probably did not have a cellar, based on the shallow depth of the foundation walls uncovered by the archeologists.

Use and Name

We know that the Stanton House cellar was used for storing food, based on a catastrophe that occurred there about 1854 as later recalled by Mrs. Stanton. A "swing shelf" holding preserves in glass jars collapsed one evening onto the foodstuffs stored below. In the jars were fruits such as strawberries and quinces, along with jellies and sweet pickles. Stored under them were "the winter supply of eggs, butter, lard etc. and jugs of fresh yeast, vinegar and sweet cider." Exactly where in the cellar the "swing shelf" was located is not known, since it is missing today. The supports for such a shelf were most likely nailed to the ceiling joists, leaving clear storage space on the floor below.¹⁸ Mrs. Stanton herself used the name "cellar" rather than "basement" in connection with her house in Seneca Falls.

Floors and Walls

The floors in the cellars of the main house and south wing are dirt, as they no doubt were during Stanton's time. The walls are the limestone foundation walls; these do not appear to have been altered from their original construction. Those in the south wing's cellar have a wide "shelf" that is believed to have been the original height of the foundation for an earlier building that existed on the site. The stone base at the south end of the south wing is also an early feature that would have functioned during Stanton's time as the support for the south-wing chimney. No historic partition walls have been identified.

Ceiling

The ceiling of the south wing's cellar is unfinished, as it probably was during Stanton's day. A center east-west beam divides the ceiling, and into it are framed the first-floor joists, which are spaced 17 inches on center.

The ceiling of the main house's cellar, on the other hand, seems to retain a historic plaster covering. The circular-sawn lath is attached with early machine-cut nails with rounded ends, and the plaster itself appears to be an early type. The extant ceiling has thus been tentatively dated 1837. A stairwell opening to the first story is believed to have been closed but not plastered over circa 1840, at the same time that other alterations were made in the house.

¹⁸ The description of the "swing shelf" is in the original hand-written copy of Stanton's autobiography *Eighty Years and More*. It was not included in the published version of the book.

Doorways

How one entered the existing cellar during the years 1847-62 is not entirely certain. Two early entrances into the main part of the cellar are believed to have been closed by this time. One was an exterior doorway in the east foundation wall, and the other a stairway to the first story. Their removal was necessary in order to create a double parlor and rear porch on the first story circa 1840. Since there is no evidence of other doorways in the main house cellar, entrance must have been gained through the south wing's cellar. It is possible that a doorway and steps were in the east wall in the southeast corner, where a bulkhead entrance exists today. Such an entrance may have led to the interior of the east wing. Unfortunately, this part of the cellar wall was completely reworked in 1902-03 when the old east wing was demolished and two stairways were built—one leading to the exterior, the other to the interior of the new east wing.

The only information about the doorways in the missing north-wing cellar was obtained by examining the north foundation wall in the main house's cellar. No evidence was found of a doorway patch in the wall, indicating that there was no internal connection between the cellars of the north wing and the main house.

Windows

Mrs. Stanton thought that windows were an important feature of a cellar. She commented in a lyceum speech written about 1880 that cellars should be "kept clean and dry, windows open constantly in the summer and as often as the weather will allow in winter."¹⁹ The architectural investigation identified four historic window openings in the existing cellar: two in the west wall of the main house, one in the north wall of the main house, and one in the east wall of the south wing. The window in the north wall was not functional when the Stantons lived in the house, because it had been covered over by the north-wing addition. Wood bars appear to have been fitted on the exterior sides of the other window frames to discourage animals from entering the cellar. The evidence for the wood bars is described in detail in the earlier section on the exterior windows. No documentary or physical evidence was found of the historic window sashes.

Chimney Bases

Two chimney bases were located in the existing cellar during Stanton's time. One, constructed of brick, was situated at the northwest corner of the main house. Although removed in 1902-03, this chimney base probably had an arched design, judging by the two brick footings excavated by archeologist Paul Grebinger in 1983. The base supported a chimney stack for two fireplaces: one on the first story, and one on the second story. The chimney is believed to have been built for the Bayard family circa 1837.

The second chimney base still exists today at the south wall of the south wing's cellar. This is an old feature that was probably associated with an earlier building on the site, according to the findings of the mortar analysis. It is constructed of stone and mortar. The archeological findings of 1983 suggest that this feature was built as a solid mass and so was never a cistern. It became the support for the south wing's chimney circa 1837, when the south wing was moved onto the site and joined to the main house.

¹⁹ Stanton, "Home Life," p. 4.

Stairway

A stairway to the cellar must have existed during the Stantons' occupancy of the house. Unfortunately, the old stairway appears to have been replaced by a later stairway during the remodeling of 1902-03. We can only guess that the stairway Stanton knew was in approximately the same location as the present stairway, and led to the first story of the east wing.

Finishes

Remnants of a painted finish indicate that a whitewash or calcimine paint at one time covered the ceilings and walls of the existing cellar. It is not known if such a finish existed during Mrs. Stanton's time. We do know, however, that she had her piazzas and wood house "whitewashed."²⁰ It is possible that she employed the same treatment for her cellar.

Room 101

Location and Size

Room 101 was one of two rooms of roughly equal size on the first story in the main part of the house. It measured approximately 17 feet 2 inches long by 15 feet 4 inches wide.

Use and Name

Room 101 must have been a room of some importance, given its location in the center of the house and facing the front. It appears to have been one half of a double parlor, based on the wide doorway that connected it with the room to the east, Room 102. It was a stylish room for the mid-19th century, having woodwork trim in the popular Grecian style. It was also an all-season room because it had a fireplace at the north wall. Both Henry B. and Elizabeth C. Stanton mentioned the "parlor" in their writings: Henry saying that he looked forward to rejoining his family there in 1852, and Elizabeth recalling the room as a setting for an argument with her father in 1855. We can further speculate that it was in the parlor that the Stantons socialized with guests as well as members of the family.

Floor

Floorboards preserved beneath later plywood and carpet in Room 101 are original to the house and therefore were extant when the Stantons lived there. This is based on a painted floor finish that shows the location of the walls of a northwest closet that existed before the alterations of circa 1840. The boards themselves are wide, varying between 6 to 6 1/2 inches. It is doubtful, however, that the floorboards were visible during Stanton's time. Floor tacks found at the perimeter of the room, and remnants of cotton fibers preserved beneath the tacks, are evidence of a possible Stanton-period floor cloth.

²⁰ Letter, Elizabeth Cady Stanton to Elizabeth Smith Miller, n.d. (1847?). Alma Lutz Papers, Vassar College Library.

Walls

All four walls that enclosed the room during Stanton's day survived in 1982. Preserved behind later plasterboard was plaster on circular-sawn lath held with machine-cut nails. The room had been completely replastered circa 1840 when the double parlor was created. Sections of circa-1840 plaster remained on all the walls in 1982. These were identified at the west end of the north wall, at the lower north and the south ends of the east wall, at the west end of the south wall, and at the lower west wall between the two windows. This plaster was a lime and sand mixture with hair binder and smooth finish. It was distinguished from the later 1902-03 plaster by its dark color. See the subsequent section "Finishes" for a description of the Stanton-period wallpaper.

Ceiling

The ceiling was plastered. Only the circular-sawn lath remained in 1982, the plaster having fallen during the Burroughs' ownership (1945-78). It is assumed that the ceiling had been replastered circa 1840 along with the walls, based on the mixture of original and later nails used to attach the lath.

Baseboards

New baseboards were installed in the room circa 1840 and would have existed during Stanton's time. These baseboards survived in their original locations at all four walls. Historic baseboards were found to be missing only from the south wall where later doorways had been installed, and from the missing north-wall chimney breast. The circa-1840 baseboards are approximately 9 inches high, with a center recessed niche and a top molding.

Doorways

Two doorways opened off this room when the Stantons lived here. One wide doorway was in the east wall, opening to the back parlor (Room 102). The second, smaller doorway was at the east end of the north wall. It functioned as the only connection between the main house and the north wing. No evidence was found for a doorway in the east end of the south wall, leading to the stair hall (Room 103), as might be expected in a house of this date. This probably stems from the fact that the main house—originally built elsewhere—did not have such a doorway.

Both historic-period doorways were missing in 1982. Their historic size and configuration were determined from remaining physical evidence. The wide doorway in the east wall had been closed, and the historic fireplace mantel moved to this location, by 1982. The width of the opening, approximately 8 or 9 feet, was clearly defined by the historic baseboards and wall plaster that survived to either side. The height was revealed upon removal of the infill material that exposed the framing lintel. Missing from this doorway were the threshold, woodwork trim (architrave and casing), and any doors that may have existed. Portions of the architrave were identified from the paint analysis to have been reused on the second story circa 1902-03. Here the architrave was found at the later hall closet, trimming the hall side of the doorway. This reused woodwork was cataloged as R054 a,b,c. It is half an inch thick with a simple bead detail on the inner edges. Missing are the band moldings on the outer edges, which were removed when the woodwork was trimmed to a narrower width. The profile of these moldings can be seen at the historic window openings at the west wall.

No evidence was found for doors in this doorway. However, they are thought to have existed, for two reasons. First, the back parlor was not heated; doors in this doorway would have allowed the back parlor to be closed off when necessary in cold weather. Second, houses of this date customarily had doors in such doorways. Two types of doors were popular for wide doorways during the Greek Revival period: sliding doors and folding doors. Sliding doors could not have existed here, because the wall was not thick enough to accommodate a door pocket. It is therefore thought that folding doors were used here. A likely design would have been two paneled doors, each hinged to "fold" in the middle. The doors were located on the Room-102 side of the doorway, based on the absence of mortises for hinges on the reused Room-101 architraves (R054).

A doorway opening in the north wall was identified from several clues. First, it was assumed that an interior connection with the north wing must have existed in either Rooms 101 or 102. Second, the north wall in the east corner of Room 101 was composed of later materials, including a baseboard reused from Room 102 (R027) and plaster applied in 1902-03. Third, removal of the north exterior siding revealed that an original wall stud and a diagonal brace had been removed here. Fourth, a portion of the right architrave from the Room-101 side of the doorway (R196) was found as part of the framing for the infill that later closed the opening. That it had come from this doorway was determined from the paint analysis and the shadow of the east-wall baseboard on the lower right side. Fifth, paint overlapped from the right-side architrave was preserved on the historic plaster in the northeast corner of the room. Finally, evidence of the threshold was discovered in the form of paint lines and floor tacks preserved on the original floorboards of Room 101. Although the door itself appears to have been discarded, it is assumed that it was similar in style to the two surviving four-panel doors in the house.

Windows

Three windows were in the front parlor during Stanton's time: two in the west wall and one in the south wall. Of these windows, the two in the west wall survived in their original historic locations in 1982. The south-wall window had been enlarged to a doorway, but considerable evidence remained of its historic configuration. All woodwork trim and associated early plaster dated to the remodeling of the parlor circa 1840.

The west-wall window on the south side was mostly unaltered from its circa-1840 appearance. Original features include the architrave, window stops, window apron and stool, and plaster panel below the window. The historic window sashes were replaced in 1902-03. They sashes appear to have been nine panes over six, based on the height of the window sash spring remnants that functioned to hold the lower sashes in an open position. Photographic evidence of nine-over-six windows elsewhere in the house may be seen in the view dated circa 1900. The west-wall window on the north side was in similar condition to the south-side window in 1982, except that its plaster panel had been replaced with new plaster in 1902-03.

The existence of an early south window was documented by the photograph of circa 1900. In this view the exterior shutters are in a closed position so it is not possible see the window sashes. The window was enlarged to a doorway in 1902-03, at which time the window woodwork was reused in a new window opening at the north wall of Room 101 (R018a,b,c,d,e, and f). It was still located here in 1982. Paint analysis indicated that all of the woodwork was original except for the sashes and left stop (1902-03) and the stool (circa 1940). The plaster panel was also later, having been

replaced in 1902-03. As with the west-wall windows, the historic sashes here were also presumably nine-over-six.

Fireplace

The room during Stanton's time had a fireplace centered on the north wall. Heat may have been provided by a parlor stove vented into the fireplace, based on common practice of the day. The fireplace and chimney were missing in 1982, but considerable evidence of their appearance remains. However, the type of evidence surviving provides no information about a heating stove.

The chimney stack projected into the room, as evidenced by brick footings in the cellar and framing in the floor and the ceiling of the room. The chimney was constructed of bricks, based on brick fragments found in the contiguous wall cavities. The bricks were probably finished with plaster similar to the walls. Baseboards trimmed the east and west sides of the chimney breast, according to paint-shadow evidence on the original floorboards and baseboards.

A hearth projected out in front of the fireplace mantel. This was evident from the patch in the original floorboards. Although no evidence survives of the hearth material, it was likely made of bricks. The exact location of the fireplace mantel was ascertained by the painted outline of the mantel base on the floorboards. The outline corresponded to the shape of the existing wood mantel (R029) at the east wall. That this mantel was not in its original location was obvious, given the fact that it was not connected to a chimney or flue. Also, other physical evidence suggested that a wide doorway had existed in the middle of this wall. Paint analysis confirmed that the mantel did belong in Room 101, and that it had been installed circa 1840 at the same time as the other woodwork in the front parlor. However, it appears to have been relocated from the north to the east wall in 1902-03 when the house was remodeled.

Finishes

No Stanton-period finishes were visible in the room in 1982. What these finishes had been was determined from close examination of the remaining historic features in the room.

The floor was probably covered with a wall-to-wall floorcloth, based on the following evidence. First, floor paint in the northwest corner of the room appears to predate circa 1840, when a closet was located here. Second, floor tacks found at the perimeter of the room outlined the threshold of the north-wall doorway to the north wing (extant from circa 1839 to circa 1880). Third, fibers preserved under the heads of the tacks were identified by a scanning electron microscope as cotton—a typical floorcloth material. Fourth, white paint was found outlining the former location of the threshold for the north-wall doorway, indicating that the threshold had been painted white. This suggests that the adjacent floor covering might have had a base coat of white paint. (There is no clue about the design presumed to have been painted over the white base coat.) This paint was color-matched to Munsell 5Y 9/1. Finally, it is known that Elizabeth Cady Stanton did not approve of carpets.²¹

No early finishes were found on the walls of Room 101 even though historic plaster dating to circa 1840 survived on all four walls. How the walls had been finished historically was therefore

²¹ Stanton, "Home Life," p. 5.

determined from information obtained in Room 102—the back parlor—since it was assumed that the front and back parlors were treated in a similar manner. Early wallpapers were discovered in Room 102, preserved on the south wall behind a chimney built in 1903. Two of the earliest layers were identified as probably dating to the mid-19th century when the Stantons lived in the house. In other words, the walls may have been papered twice between 1847 and 1862. Unfortunately, all that remained of these two papers were small fragments with no discernable repeat. Luckily, a well-preserved historic wallpaper found in Room 104 was similar in coloring to the paper dated “circa 1847” in Room 102. This paper has a cream-color background, light blue vertical stripes and geometric forms, and small green shapes. While this paper is later, having been dated “circa 1850s,” it is also believed to have been installed by the Stantons. For a discussion of wallpaper dating techniques used at the Stanton House, see Chapter III of this report, “Physical Investigation and Analysis: Architecture.” A listing of wallpaper samples and individual layers may be found in Appendix D.

The ceiling is believed to have been painted with a white water-soluble calcimine. This was determined by studying the ceiling in the east adjacent room (Room 102), because no historic ceiling plaster survived in Room 101. Paint samples were removed from the circa-1840 plaster ceiling in Room 102 and studied under the microscope. Although it was not possible to pinpoint the paint layer(s) from the Stanton period, it was observed that all early paint layers on the ceiling were white calcimine paint. It was therefore concluded that some of these early layers probably dated to the period 1847-62.

The woodwork in the room was decoratively painted to resemble oak graining. This included the baseboards, the trim around the doorways and the windows, and the fireplace mantel. Paint analysis identified the oak graining as the second grained finish on the woodwork installed circa 1840. It is likely that Mrs. Stanton had this finish applied in 1847. Three materials were used to create the imitation oak: a painted base coat, a stain, and a protective varnish. The base coat is a yellow color that was matched to Munsell 2.5Y 8.5/6. It did not contain lead, according to a spot test using sodium sulfide. Samples of the oak graining that had not been painted over were found to have been preserved within the walls of the room when the north and east doorways were enclosed circa 1880. Enough remained of these woodwork fragments to identify them as doorway architraves installed in the parlor circa 1840. They were cataloged as R034 and R196. It was not possible to determine conclusively how the historic doors and window sashes were finished, since none remained on either side of the double parlor. It is probable that they were painted with the same oak graining as the other woodwork in the room.

Room 102

Location and Size

Room 102 was one of two rooms of roughly equal size on the first story in the main part of the house. It measured approximately 17 feet 2 inches long by 11 feet 11 inches wide.

Use and Name

Room 102 is thought to have been the back half of the double parlor during Stanton's day. This is based on the physical evidence of a wide doorway connecting Room 101 with Room 102, and on the similarity of woodwork trim used in both rooms circa 1840. It may have been known, along with Room 101, simply as the "parlor," as mentioned in the writings of both Henry and Elizabeth Cady Stanton. (For specific quotes, see the discussion of Room 101.) It is likely that the back parlor was used primarily in the warm-weather months, given the fact that it had two exterior glazed doorways and no fireplace. However, it would not have been closed off completely, since one apparently had to pass through this room to get to the front parlor and to the rooms in the north wing.

Floor

The original floorboards were preserved beneath a later oak floor. These original boards are wide, averaging approximately 6 1/2 inches. Shorter boards fill in what was most likely an early stairway to the cellar. The stairway opening is believed to have been enclosed circa 1840 at the same time the double parlor was created. The floor patch therefore would have existed when the Stanton family lived in the house.

Walls

All four walls of the historic back parlor existed in 1982, albeit in altered condition. Preserved beneath later wood paneling was some plaster dating to circa 1840 on circular-sawn lath held with machine-cut nails. This early plaster survived at the west end of the north wall; at the north and south ends of the east wall, and as a vertical strip in the middle; at the south wall behind the chimney built in 1903; and at the lower north end of the west wall. This early plaster was visually distinguishable from the later plaster applied in 1902-03 by being darker in color. Mortar analysis determined that this early plaster was the same lime and sand plaster used in the front parlor (Room 101) circa 1840. Some historic wall material was missing in 1982, due to the installation in 1902-03 of a new doorway in the south wall and a new window in the north wall.

Ceiling

The ceiling was plastered during Stanton's time, similar to the ceiling in the front parlor. This plaster was applied to circular-sawn lath held with machine-cut nails. Unlike as in the front parlor, much of this early plaster ceiling survived in 1982 beneath modern acoustical ceiling tiles. Early plaster was distinguished from later plaster applied in 1902-03 by its darker color. Mortar analysis was also carried out to confirm that the dark plaster had been applied circa 1840 at the same time as the wall plaster. This plaster also covered over what had earlier been a stairway opening to the second story.

Baseboards

The baseboards in the back parlor were identical in style to the baseboards in the front parlor. These were approximately 9 inches high with a middle recessed niche and a top molding detail. Paint analysis confirmed that the baseboards had been installed circa 1840. Some survived in their original historic locations in 1982. These were all located at the north end of the room: at the north

wall, the north end of the east wall, and the north end of the west wall. Some baseboards were identified by the paint analysis to have been removed from Room 102 and reused in Room 101 during renovations in 1902-03. They ranged in size from small fragments to several feet in length. Reuse catalog numbers were assigned to these baseboards as listed below:

R027	3 feet 9 3/4 inches long
R028	small vertical slice
R032	3 feet 7 3/4 inches long
R033	2 feet 1 1/2 inches long
R041	2 feet 1 1/2 inches long

Doorways

Four doorways opened off this room during Stanton's day. By 1982, one doorway survived in altered condition and three had been closed.

The one surviving doorway was in the west side of the south wall. However, it no longer led into Room 102; since 1902-03, it been the entrance to an enclosure that had been partitioned from Room 102 to enclose the new stairway built during that remodeling. The framing for this opening suggests that it was originally an exterior doorway, before the main house was moved and connected to the south wing. By the time the Stantons lived here, this was an interior doorway that linked the main house with the south wing on the first-story level. The parlor side of the doorway had previously been altered circa 1840 when new woodwork trim was installed. Although the trim and the door had been replaced with new materials in 1902-03, it was discovered that some of the circa-1840 trim had been reused in Room 101 at the new exterior doorway in the south wall. This was based on the paint analysis and other physical clues such as paint lines and original nail holes. The two reused trim pieces were cataloged as R030a (left side architrave) and R030c (right side architrave). Close examination of the left-side architrave revealed that two mortises had originally existed on the interior side of the architrave. It was deduced from this evidence that the mortises were for two door hinges. Thus was discovered the location and swing of the door, even though the door itself was missing. The exact appearance of this door may never be known. It probably had four panels, like the two original doors that survived in the house: one (R063) from the first story of the south wing, the other (R039) from the second story of the main house.

The second doorway was a wide opening in the west wall that connected the back parlor with the front parlor (Room 101). By 1982, the opening had been closed with lath and plaster, and covered over by a stairway to the second story and a closet, both installed in 1902-03. The evidence for the wide doorway has been discussed in connection with Room 101. No doorway materials, such as architraves or doors, survived from the back-parlor side of the opening. The architraves were of the same style as those in the front parlor, Room 101. This is based on the remnants of the south and west doorway architraves, which were found to have been reused in Room 101 in 1902-03.

The remaining two doorways were both located in the east exterior wall. One had been replaced by a window and the other enclosed with lath and plaster in 1902-03. Their existence during Stanton's time was initially discovered upon removal of the later wallpaper to uncover the east plaster wall. Careful examination of the plaster revealed that there were two large floor-to-ceiling patches dating to 1902-03. Upon closer scrutiny it was found that the straight outlines of the missing architraves were still visible where the old plaster abutted the later plaster patches. This was

particularly true of the center strip of historic plaster where the top projections (a.k.a., "dog ears") of the architrave lintels could be seen. Because these openings were in an exterior wall, it was initially assumed that they were windows, or possibly one window and one doorway. This was logical, given the fact that these were the only exterior openings in the room. Other evidence, however, suggested that these were in fact doorway openings fitted with paired glass doors—i.e., French doors. The evidence for doors included mortises for two thresholds in the east adjacent floorboard and a center mortise for the door closure hardware preserved in one architrave lintel reused in Room 101. The architrave lintel had been patched and reused in Room 101 at the south exterior doorway in 1902-03. It was cataloged as "R030b." Most compelling in the doorway-versus-window argument is the fact that the openings were approximately 36 to 37 inches wide, or about the same width as other doorways in the house. By comparison, the existing historic windows in the west wall of Room 101 were only 27 1/2 inches wide. Unfortunately, no side architraves and no doors survive from the two doorways.

Windows

There were no windows per se in Room 102. Natural light would have been provided to the room by means of the two doorways in the east wall that appear to have been fitted with French doors. These doors have been discussed in detail in the previous section "Doorways."

Stairway

The back parlor originally consisted of two rooms, one of which was a stair hall with a staircase to the second story. A stairway to the cellar also appears to have been located here at one time. Both had been removed and replaced by the double parlor by the time the Stanton family occupied the house.

Fireplace

Despite exhaustive investigation, no evidence was found for either a fireplace or a heating stove in the back parlor during the historic period. The nearest heat source appears to have been the fireplace in the front parlor, Room 101. A common practice of the day was to close off unheated rooms during the winter. This could have been done by the Stantons, but such action would have impeded circulation between the front parlor (and north wing) and the rest of the house. In any case, it seems certain that the Stantons—along with many of their contemporaries—simply lived with substantially less heat than we expect today.

Finishes

It was determined by the finishes analysis that the front and back parlors were both finished in the same manner when the Stantons lived in the house between 1847 and 1862. For a description of those finishes and the methods used to identify them, see the previous section on Room 101.

Room 103

Location and Size

Room 103 was located on the north side of the south wing on the first story. It was the smaller of two rooms that existed on the first story, measuring approximately 16 feet 1 inch long by 7 feet 10 inches wide.

Use and Name

The physical evidence indicates that before the Stantons moved into the house, Room 103 consisted of two separate rooms without a staircase. The front room functioned as an entry hall, because the main exterior doorway was located in its west wall. The role of the small back room is not known. This arrangement was changed circa 1840, when the north-south partition wall was removed and the former back room was outfitted with a staircase to the second story. The room thus functioned as an entry and stair hall by the time the Stanton family took up residence in 1847. It was also the room through which one passed to get from one end of the house to the other. No specific references to the hall are found in the historical documentation. We have only one indirect reference to a stairway (presumably the main stairway) by Elizabeth Cady Stanton, who described her cousin's visit in the winter of 1850-51; Elizabeth Miller wore the new "bloomer" costume during her stay as described by Stanton:

To see my cousin, with a lamp in one hand and a baby in the other, walk upstairs with ease and grace, while, with flowing robes, I pulled myself up with difficulty, lamp and baby out of question, readily convinced me that there was sure need of reform in woman's dress, and I promptly donned a similar attire.²²

In conclusion, "hall" seems an appropriate descriptive name for Room 103.

Floor

The original floorboards were preserved beneath a later oak floor. These boards measured approximately 6 inches wide and are believed to have been installed about 1837 when the south wing was joined to the main house. Close examination of the floorboards proved invaluable in deciphering the historical appearance of this room. Paint lines, floor tacks, and a mortise were used to identify the precise locations of the missing partition walls and doorways, the missing stairway, and the missing stair newel post.

Walls

Three of the four historic walls that defined the hall during Stanton's day existed in 1982 beneath modern plasterboard. These were the north, the west, and the south walls. A portion of the historic north wall was missing where two posthistoric doorways had been added. Original lath nails in the studs of the three extant walls measured approximately 1 inch long. Although the lath and plaster had been removed from all three walls in 1902-03, small samples of early plaster were

²² Stanton, *Eighty Years*, p. 201.

found to have fallen into the wall cavities of the east wall. Mortar analysis identified the plaster as a lime type with hair binder. Both the plaster and lath are believed to date to about 1837 when the south wing was joined to the main house. That the plaster is not earlier than this is indicated by the fact that the lath at the north wall is nailed directly to the framing studs of the adjacent main house. The one missing wall, the south partition, had been removed at the same time as the stairway in 1902-03. Its exact historic location was deduced from two pieces of evidence: a shadow on the floor caused by the absence of floor paint, and shortened ceiling joists that had been supported by the partition in the vicinity of the stairwell. An earlier north-south partition that predated the stairway was also identified from paint-shadow evidence on the floor.

Ceiling

The ceiling during Stanton's time was 12 inches lower; it was heightened during the remodeling of 1902-03. Remnants of the lath nails indicated that the ceiling had been plastered at the same time as the walls—circa 1837—and selectively replastered when the staircase was installed circa 1840. The lath had not been nailed directly onto the ceiling joists, but rather to wood that was scabbed onto the sides of the joists—perhaps to achieve a level ceiling. No ceiling existed at the east end of the room where the stairway was located. Although closed up by 1982, the exact location of the opening was identified from the shortened ceiling joists, the cut-off ends of which retained evidence of lath and plaster. Of the 12 total joists, six were cut back to make room for the new staircase circa 1840.

Baseboards

Two types of baseboards probably existed in the hall by 1847: the original baseboards installed circa 1837, and later baseboards installed at the same time as the circa-1840 staircase. All were removed during renovations in 1902-03. One of the old baseboards, however, was found during the architectural investigation in 1982 to have been reused within the ceiling on the second story in 1902-03. This baseboard, cataloged as R108, measures 5 feet 6 inches long by 6 1/2 inches high by seven-eighths of an inch thick, and has a simple top-bead detail. Presumably the new baseboard installed circa 1840 at the base of the stairway displayed a similar style.

Doorways

Four doorways were in the hall by 1847: one exterior doorway in the west wall, two interior doorways in the north and south walls, and one closet doorway beneath the upper run of the stairway. All four had been either altered or removed by 1982, but physical evidence of their historic appearance was uncovered during the architectural investigation. Each doorway is discussed in detail below.

The exterior doorway in the west wall is believed to have been the front doorway of the house circa 1837 and during Stanton's day. All that remained of the doorway in 1982 was the opening itself. All other elements, including the woodwork trim and the door, had been replaced in 1902-03, according to the paint analysis. That this was in fact a historic doorway was deduced primarily from the exterior photograph of circa 1900, which showed this as a doorway in the Greek Revival style (1820-1860) with sidelights. It is believed to date to 1837, when the south wing was joined to the main house. Reconstruction of the exterior appearance of the doorway relied heavily on the photograph and fragments of the exterior trim that had been reused in 1902-03.

Unfortunately, less information was available on the interior detailing. It is possible that the interior architraves incorporated moldings similar to those of other historic doorways on the first story of the south wing.

The interior doorway in the north wall entered the back parlor (Room 102) and was the connection between the south wing and the main part of the house. It, too, has been dated circa 1837. As with the exterior doorway, all that survived of the interior doorway in 1982 was the opening itself. Both the woodwork trim and the door had been replaced in 1902-03. Fragments of the two side jambs were found to have been reused in the new south doorway, based on their width and the paint analysis. These were cataloged as R093a and b. The header piece had been reused on the second story and was cataloged as R113. The paint analysis also identified reused architrave fragments from Room 103 that may have come from this doorway. These were cataloged as R021, R043a and c, R045, and R062c. Early paint layers identified by the paint analysis suggest that both the jamb and the architrave woodwork date to circa 1837. The architraves are characterized by having an attached Grecian ogee molding. The door itself appears to have been discarded in 1902-03. It may have had four panels, as did the two original doors that survived in the house, R039 and R063.

The interior doorway in the south wall entered the other first-story room in the south wing, Room 104. A likely date for this doorway is also circa 1837. The doorway was completely missing in 1982, having been removed along with the south partition wall in 1902-03. Its historic location and size were identified from evidence preserved on the original floorboards. This was a painted silhouette of the doorway's architrave moldings and threshold created when the floor was painted with the doorway in place. Pieces of the jamb were reused on the second story in 1902-03. That they came from this doorway was determined from their width and the paint analysis. The jamb fragments were cataloged as R107, R112, R114, and R115. Architrave fragments that may have come from this doorway were also reused in 1902-03. Their catalog numbers are listed in the preceding paragraph. The door itself was missing by 1982, but it probably had four panels like a door (R063) that survives from Room 104. A hinge (R068) that may have come from this door was found reused on the second story. That it came from Room 103 was determined from its early paint layers. The hinge is made of cast iron. Each leaf has four vertically aligned holes for the screw attachments.

A closet doorway, built circa 1840 at the same time as the curved stairway, was in the room by the time the Stantons moved to Seneca Falls. Both the closet and the stairway were missing by 1982, having been removed in 1902-03. That a closet had existed at all was determined from paint evidence on the floor and fragments of the doorway architrave that had been removed and reused in 1902-03. The painted outlines on the floor clearly indicated that the closet was located beneath the upper run of the stairway. The architrave was plain except for a single-bead detail on the interior edge. This was deduced from three pieces of the architrave found in reuse locations in 1982: R088, R099, and R116. Piece R116 provided the most valuable information, being the unaltered right-side architrave complete with door strike-plate hardware. Based on this architrave, it was possible to determine the height of the doorway, the swing of the door, and the probable type of door hardware. The hinges were 3 1/2 inches high, as evidenced by a mortise in the remnant of the left-side architrave (R088). The door itself appears to have been discarded in 1902-03. While the available evidence has revealed the door's size, it offers no clue as to its style.

Windows

Windows were located in both the west and the east walls by 1847.

The windows in the west wall were the sidelights on either side of the front doorway. They were removed in 1902-03. That they had existed was discovered upon close examination of the earliest exterior photograph of the house (dated circa 1900), which shows the front doorway. The sidelights may be seen as vertical in orientation, narrow, and divided by horizontal muntins into three panes of glass. Panels appear to have been located below the sidelights.

A standard window with nine-over-six sashes was in the east wall. All that survived of this window in 1982 was the opening itself, its associated woodwork having been replaced in 1902-03. The original architrave, however, was found to have been cut into five pieces and reused elsewhere in the house: one within a wall (R096), and four at the new opening to the attic in the south wing (R168, 173, 174, and 175). That the architrave fragments came from this window was determined conclusively from the paint, remnants of wallpaper, nail holes, and a horizontal paint line where the stairway installed circa 1840 had abutted it. Early paint layers on the architrave indicate that it was original (circa 1837) and existed when this area was a small back room. The style of the architrave is plain boards with no moldings. That the sash type had been nine-over-six was determined from a mortise for a Merriman-type sash spring that would have functioned to hold the lower six-pane sash in an open position. This mortise was on the right (south) side of the window opening.

Stairway

An open stairway is believed to have occupied the east half of the room by the time the Stantons moved to Seneca Falls in 1847. The stairway was built at the same time the existing stairway was removed from the main house to create a double parlor. This was determined from the distinctive type of machine-cut nails that were found in association with the work. Exactly when this remodeling was done is not known. The date "circa 1840" has been assigned based on the style of the new woodwork trim in the double parlor, associated wallpaper, and the fact that Elizabeth Cady Stanton did not mention the alterations in her writings.

The stairway was missing by 1982, having been removed during the remodeling of 1902-03. Luckily, pieces of the disassembled staircase had been saved and/or reused in 1902-03 and were discovered during the architectural investigation. These pieces included samples of the treads and risers (R185 and R194); the landing floorboards (R006, R009, R071, and R126); the landing baseboards (R001 and R161); three newel posts, several railings, and 14 balusters (R046, R047, R048, R049, R050, R051, and R052); and other miscellaneous trim pieces (R072, R121, R122, R124, R125, R127, R106a, R155, R170, and R177). Other physical clues in Room 103 helped to precisely locate the stairway elements. These included painted outlines on the floorboards, the cut-off tenon of the first-story newel post, the painted line of the landing where it abutted the east window's architrave, and cuts in the ceiling joists where the stairwell opening had been located. Combining all of this evidence, it was possible to determine fairly accurately the appearance of the staircase during Stanton's day.

The stairway was a dog-leg design, reversing direction at a center landing. The lower run ascended eastward, while the upper run ascended westward. The landing that separated them was located at the east wall 40 inches above the first story, as evidenced by the paint line on the original

east-window architrave. The landing was reached from the first story in approximately five steps, based on an average measurement of 8 inches per riser. Access from the landing to the second story would have required another seven steps. The stairway was therefore comprised a total of 12 steps or risers, including the landing. Enclosure of the stairway was provided by the south, east, and north walls of the room. The handrail was located on the interior side—the left side as one climbed the stairway. This handrail was supported by a newel post on the first story, a newel post on the second story, and balusters placed two per step. The styling of both the newels and the balusters suggests that they were turned on a lathe. Assembly of the railing was accomplished using mortise and tenon joints.

A closet was incorporated beneath the stairway, as previously mentioned in the section “Doorways.” This closet was located on the first story against the north wall and beneath the upper run of the stairway. It measured approximately 3 feet square, according to the paint evidence on the original floorboards. Its back, or east, wall probably provided structural support for the stairway.

Fireplace

There was no fireplace in the hall, nor was any evidence found for an alternative heat source such as a stove. We can conclude from this that the hall was unheated during Stanton’s time.

Finishes

No Stanton-period finishes survived in Room 103 in 1982. Their identification therefore involved some detective work and some conjecture.

The floor may have been covered with a floorcloth as in Rooms 101-102, based on floor tacks that were found at the perimeter of the room and the stairway. The background color of this floorcloth may have been white, matching the historic color of the stair treads, risers, balusters, and baseboards. Paint analysis of the staircase fragments matched the white to Munsell 5Y 9/1.

The plaster walls were wallpapered. Because no plaster or wallpaper remained on the walls in 1982, this was determined from large sheets of plaster with attached wallpaper that were found beneath the front porch, where they were discarded in 1902-03 (W017). That the plaster and wallpapers had been removed from Room 103 was based on the earliest layer of wallpaper dated circa 1840. Scraps of this paper were identified in two other locations associated with Room 103: a contiguous east wall cavity (W018), and the original east-window architrave. The wallpaper that was identified as likely dating from the Stanton period, 1847-1862, was the second layer. This wallpaper is a machine-made paper composed of cotton fibers. The design, which was block-printed, is a gray foliate pattern with accents of green lines on a white background. Also found with this paper was a small scrap of a flocked border that was applied on top of the wallpaper near the ceiling. Although only the lower portion of the border survived, it was possible to determine that it had been a foliate design printed in colors of mustard yellow, burgundy, green, and black, with an olive-green flock. Its original width was probably about 3 inches, as was typical in the mid-19th century.

No ceiling plaster or plaster fragments survived in Room 103. The ceiling may have been finished in a manner similar to the ceiling in Room 102—with a white calcimine paint.

The woodwork trim and the stairway (except the handrail and newel) were painted with a white lead-based oil paint by 1847. All of the historic woodwork had been removed from the room in 1902-03, although much of it was found to have been reused throughout the house during the remodeling. Paint analysis of this reused woodwork determined that it was originally painted cream circa 1837, grained like the double parlor circa 1840 when the stairway was installed, and then painted white circa 1847. This white paint was color-matched to Munsell 5Y 9/1. The stairway handrail and newel, on the other hand, were finished with a dark resinous finish such as varnish or lacquer; these elements survived in unpainted condition in 1982.

Room 104

Location and Size

Room 104 was the large south room on the first story of the south wing. It was immediately adjacent to the entry/stair hall to the north and the wing to the east. Its dimensions, including the closets, were approximately 16 feet 1 inch long by 15 feet 6 inches wide.

Use and Name

No documentary information is known that reveals the historic name or use of this room. The room did have an original circa-1837 fireplace, so it may have been here that Elizabeth Cady Stanton later recalled plotting and planning with Susan B. Anthony in front of an "old-fashioned fireplace." It is possible that this was a sitting room—a place for social gatherings that was less formal than the double parlor in the main part of the house. Another possibility is that this was the dining room, being immediately adjacent to the east wing that is believed to have housed the kitchen. Alternatively, the east wing was of sufficient size to have contained both the kitchen and the dining room. The answer may never be known, since the east wing was demolished in 1902-03, and no historical documentation of the east wing or this room has been found to date.

Floor

The original wide floorboards were preserved in 1982 beneath narrow oak floorboards and wall-to-wall carpeting. For a discussion of the floor covering, see "Finishes."

Walls

The walls were plastered. The only historic walls that survived in this room in 1982 were the exterior east, west, and south walls. These, however, had been altered in 1902-03 when the old lath and plaster were removed and replaced with new lath and plaster. Only a small area of the original circa-1837 plaster was preserved behind a new north partition wall that was installed in 1902-03. Mortar analysis identified this as a lime and sand plaster with a hair binder. The lath to which it was adhered was a split type.

Missing in 1982 were the historic north and south partition walls, both having been removed during the remodeling of 1902-03. The north partition separated Room 104 from the hall (Room 103). Its exact location was preserved on the old floorboards in the form of a "shadow" that was created when the floor was painted with the wall in place. The south partition enclosed the fireplace

chimney stack and created space for two small closets, one on either side of the fireplace. The east closet contained a steep stairway to the second story. The stairs are discussed in detail in the sections entitled “Ceiling” and “Stairway.” The west closet was probably used for storage.

Ceiling

The ceiling was lower and plastered in Stanton’s day; it was heightened 12 inches in 1902-03. The plaster and lath also dated from 1902-03. However, traces still remained of the old ceiling in 1982: lath nails of circa-1837 vintage, boards scabbed onto the sides of the joists, and white stains from the early plaster were all preserved beneath the later ceiling. Pieces of the original ceiling plaster were also found preserved within the exterior wall cavities. Mortar analysis confirmed that the composition of the ceiling plaster was the same as the historic plaster walls.

One opening existed in the ceiling, in the southeast closet; this was the opening for the stairway to the second story. Although the opening had been closed in 1902-03, evidence of it survived in 1982. Still extant were the historic floor joists that had been cut back and supported on the south partition wall. Compressed floorboards were further proof that the missing partition wall had functioned as a bearing wall for the floor. Plaster stains on the ends of the joists were evidence that the stairway opening existed circa 1837 when the interior of the south wing was plastered.

Baseboards

The baseboards were approximately 6 1/2 inches high and 1 inch thick. They were simple in design, with only a bead molding along the top. They are believed to have been installed circa 1837. None of these baseboards survived in 1982 in their original locations, all having been removed in 1902-03. Five sections were reused at this time in new locations: two at the south wall of Room 104 (R007 and R008), two within a new closet on the second story (R003 and R004), and one within a wall (R015). Paint analysis determined that these baseboards had come from Room 104. This was accomplished by comparing the early paint layers on the baseboards with the paint layers on the only historic woodwork that survived in its original location in Room 104—the window architrave in the south end of the west wall. The early paint layers were found to be identical on both the baseboards and the window woodwork.

Doorways

Four doorways were in this room historically: one in the north wall, one in the east wall, and two in the south wall. All had been removed during the remodeling of 1902-03. Several clues of their earlier appearance, however, survived in 1982.

The north doorway connected Room 104 with the entry and stair hall (Room 103). It is believed to have been installed circa 1837. The doorway was removed in 1902-03 at the same time as the partition wall in which it was located. Evidence of its historic location was preserved on the floorboards in the form of painted silhouettes of the architrave moldings and the threshold. Jamb fragments that were reused throughout the house in 1902-03 were cataloged as R107, R112, R114, and R115. Architrave fragments that were also reused and may have come from this doorway were cataloged as R020, R022, R057, R062a and b, and R119. The architrave was characterized by its attached Grecian ogee molding. The door itself was missing in 1982, but it probably had four panels, based on the old door (R063) from the southwest closet.

The east doorway connected Room 104 with the east wing. It was relocated farther north in this wall during the remodeling of 1902-03. Its historic location was identified in 1982 from floorboards that were observed to continue under a portion of the wall that was infilled in 1902-03. Little else is known about this doorway. Presumably it was trimmed with woodwork similar to that of the other doorways and fitted with a paneled door.

Of the two doorways in the south partition wall, one was on the east side of the fireplace and opened onto the stair closet. It is believed to have been installed circa 1837. The doorway had been removed in 1902-03 along with the partition. Evidence of its location was found in 1982 preserved on the floorboards in the form of a painted silhouette of the architraves and the threshold. The doorway was narrow, measuring only 2 feet 2 inches wide. The height of the doorway opening was determined based on the left jamb that was found intact in a second-story closet, where it had been reused in 1902-03 (R102). Three additional fragments were also found reused within the ceiling of the second story and were cataloged as R109, R110, and R111. The architrave on the room side had a Grecian ogee molding, judging by the floor silhouette. Some of the architrave fragments reused in 1902-03 and listed for the north doorway may have come from this doorway. The architrave on the closet side of the doorway was a plain board, based on the floor silhouette. Two fragments of plain architrave that may have come from this doorway, based on the paint analysis, were cataloged as R090 and R181. These architraves measure 3 inches wide by seven-eighths to 1 inch thick. The door itself was missing in 1982. However, evidence on the left jamb indicates that the door opened into the room, being hinged on the right side and latched on the left side. It probably had four panels, like the closet door (R063) on the west side of the fireplace.

The doorway in the south partition wall on the west side of the fireplace opened to the storage closet. It, too, is believed to have dated to circa 1837, being removed in 1902-03 along with the partition. Evidence of its location in the wall was found in 1982 as a floor silhouette on the old floorboards that outlined the threshold. The width of this doorway was approximately 2 feet 2 inches, similar to that of the doorway at the east closet. The architraves are presumed to have had an applied ogee molding on the room side and no molding on the closet side. Preserved intact on the second story were the jambs and header piece, along with the paneled door, which had been reused in 1902-03 in a second-story closet. The jambs were cataloged as R064 and the door as R063. The door opened into the room, based on the paint analysis, which identified the side of the door that had a paint-layer sequence matching that of the room. It was hung on the east jamb with two hinges, each leaf of which was attached with four vertically aligned screws. The door itself had four panels and was latched with a small spring-bolt latch that had replaced an earlier Norfolk latch around 1840. The shadow of the Norfolk latch was still visible on the door in 1982; the paint layers that covered its silhouette were used to date its removal. Also missing by 1982 was the spring bolt latch, which was replaced by a doorknob in 1902-03. Remnants of the latch included the strike plate, which survived on the west jamb, and a shadow of the latch on the door.

Windows

Two windows provided natural light to Room 104, both of which were in the west wall. These windows are documented by the exterior photograph of circa 1900 that shows them fitted with nine-over-six sashes. They are believed to have been installed circa 1837. The photograph shows no windows in the south elevation, indicating that the two window openings that were here by 1982 had been added sometime after circa 1900.

The historic window that was in the south side of the west wall survived mostly intact in 1982. Much of the woodwork was original and unmoved from its original circa-1837 location, including the architrave with Grecian ogee molding, the stool and apron, and the left (south) window stop. The window sashes had been replaced in 1902-03, although it was surmised from the historic photograph that they had been nine-over-six. The bottom sash had been held open with a Merriman-type window sash spring, the mortise for which survived in the right (north) side of the frame. The Merriman window spring was patented in 1835, so there is a good possibility that it existed during Stanton's time.

The historic window that was in the north side of the west wall was considerably altered by 1982. All that survived was the opening itself. All of the historic woodwork had been removed and replaced with new woodwork in 1902-03 when the north partition wall was moved, thus making the window part of Room 103. Fragments of the circa-1837 window woodwork were found to have been reused throughout the house and included pieces of the architrave (R005, R056, R082, and R117) and the sash stops (R091, R092, and R095). It is clear from these fragments that the window was identical in appearance to the adjacent window to the south. A Merriman-type window sash spring was also located in this window based on a cutout in the right (north) side frame.

Stairway

A steep staircase to the second story was located in the southeast closet during the historic period. The stairway appears to have been built circa 1837, when the south wing was joined to the main house. It was missing in 1982, having been removed in 1902-03 along with the closet partition wall. However, several clues survived as to the appearance of the staircase.

The first indication that a stairway had existed in the room was the finding of an opening in the ceiling that measured approximately 2 feet wide by 4 feet 6 inches long. It had been created by cutting back four ceiling joists in the southeast corner of the room, which were then supported on a new partition wall. No trace of the stairway itself survived in 1982, although it probably did exist, based on the opening in the ceiling. Logic suggests that the stairway was simple in design, given its hidden location within a corner closet and the constricted space. The angle must have been steep, suggesting that the stairway may have resembled a ladder with open risers. It probably ascended from east to west, based on the placement of the closet doorway and the slope of the ceiling on the second story. This would have enabled the stairway to be supported in part by the brick chimney stack on the west side of the stair closet.

Fireplace

A fireplace was located in the room in the middle of the south wall. It is believed to have been built circa 1837 when the interior of the south wing was finished as a residence. The fireplace was missing by 1982, having been removed along with the entire chimney stack in 1902-03. That it existed historically is based on the exterior photograph of circa 1900, which shows a brick chimney stack projecting above the roof at the south end of the south wing. More specific information on the appearance of the fireplace in Room 104 is provided by the remaining physical evidence.

The chimney stack projected into the room, based on the circa-1900 photograph previously mentioned, the framing in the floor, and the framing in the ceiling. However, this would not have

been immediately apparent in Room 104, since a partition wall concealed the chimney stack. The chimney stack was probably composed of bricks; not only were fragments of bricks found in the exterior south-wall cavities, but also mortar stains were discovered on the framing for the ceiling at the opening for the chimney stack. Bricks were likely also used for the hearth and the interior firebox of the fireplace. The dimensions of the hearth were ascertained by measuring the floor patch installed in 1902-03.

A wood mantel dating to circa 1837 framed the firebox opening of the fireplace. It was neoclassical in design with two pilasters, one on either side of the opening. The mantel was removed and disassembled in 1902-03, and two of the large pieces were reused as floor joists to fill in the hearth area. It is because of these pieces, cataloged R065a and b, that we know what the lower portion of the mantel looked like. These two fragments are the two sides of the mantel to which the pilasters had been attached. Each measures 3 feet 8 1/2 inches high, having been shortened in 1902-03. Although the pilasters themselves were removed in 1902-03, their shapes are clearly silhouetted by the painted finish. The height of the mantel opening was 2 feet 10 1/8 inches, based on the placement of the mortise for the upper panel in the most complete mantel board (R065a). Confirmation that the mantel fragments were from Room 104 came from the paint analysis and the scraps of wallpaper adhered to the outer edges. Exactly what the upper portion of the mantel looked like is not known. It may have had a shelf, in keeping with the Greek Revival style of the 1830s and resembling the circa-1840 mantel in Room 101.

Finishes

Stanton-period finishes were identified for all elements of the room in 1982. The floor was probably covered with a floorcloth, as in Rooms 101, 102, and 103. This is based on tacks that were found in 1982 at what had been the perimeter of the room, but not in the closets. The closet floorboards appear to have been painted yellow (Munsell 2.5Y 7/6), based on the paint analysis. It is likely that the body of the floorcloth in the main part of the room was the same yellow color.

The walls appear to have been wallpapered twice by the Stantons. This was determined by dating samples of the paper that were found loose in the wall cavities, preserved in situ at the west wall behind the later north partition wall installed in 1902-03, and discarded beneath the front porch built in 1902-03. The complete layering of papers, along with the circa-1837 plaster substrate, was preserved behind the partition and beneath the porch. Wallpaper layers three and four are likely to have been hung by the Stantons, based on their stylistic characteristics. Both are machine-made papers composed of cotton fibers and printed with designs using machine rollers. Layer three, dated circa 1847, is a rococo design in colors of gold, red, and green on a plain paper background. Layer four, dated circa 1850s, is a striped paper with geometric designs in colors of light blue and green on a cream background. This paper is similar in coloring to another early wallpaper fragment found in Room 102.

The ceiling was most likely finished with a white calcimine paint. This was based on fragments of circa-1837 ceiling plaster that were found in the exterior wall cavities, which were finished with multiple layers of early white calcimine, according to the paint analysis.

The woodwork was decoratively painted circa 1847 to resemble wood graining, according to the findings of the paint analysis. This graining was observed to be the fourth finish applied to the circa-1837 woodwork. It included a cream-color base coat (color-matched to Munsell 5Y 9/2),

a stain, and a protective varnish. Samples of this graining were found on three pieces of a door jamb that had been removed and reused within a second-story ceiling in 1902-03. These jamb pieces were cataloged as R109, R110, and R111. They are believed to have been removed from the doorway to the stair closet in the southeast corner of the room. The graining preserved thereon is an imitation of oak with pronounced medullary rays. The technique used to produce this graining appears less skilled than that used in Rooms 101-102, suggesting the work of a different hand in Room 104.

Room 201

Location and Size

Room 201 was the front room on the second story in the main part of the house. It and Room 202 were of roughly equal size and adjacent to one another. Room 201 measured approximately 17 feet 2 inches long by 13 feet 6 inches wide (including the closets). Access to Room 201 was through Room 202 that was off the main stair hall.

Use and Name

The location of this room on the second story strongly suggests that it was used as a bedroom. It may have been one of the rooms described by Elizabeth Cady Stanton after the birth of her second daughter when she wrote in 1856, "I pace up and down these two chambers of mine like a caged lioness."²³ A chamber denoted a bedroom in the 19th century.

Floor and Walls

The floor was composed of floorboards that varied in width from 5 to 9 inches. Most of these boards survived in their original locations in 1982.

Room 201 was historically enclosed by three exterior walls and two interior partition walls. The exterior walls were the north, west, and south walls of the main house. One partition wall divided Room 201 from Room 202 and served as the east wall of the room. The second partition wall was located on the north side of the room and functioned to conceal the fireplace chimney and provide enclosure for two closets, one on either side of the fireplace. All of the walls were plastered on circular-sawn lath held with machine-cut nails. The plaster is a lime and sand type with a hair binder. The walls appear to have been replastered on original lath before the Stantons occupied the house in 1847; the lath has been dated circa 1835 and the plaster circa 1840.

Most of the exterior north, west, and south walls survived intact with most of their historic circa-1840 plaster in 1982. Missing, however, was a portion of the east end of the south wall, this having been removed in 1902-03 to make room for the new hallway. Also missing were the east and north partition walls that were removed and replaced with new walls in 1902-03. The new east partition was located approximately 3 feet west of the historic partition, and the new north partition in approximately the same location as the old closet partition. The historic placement of the missing east partition wall was identified in 1982 by a dark shadow on the original floorboards and a

²³ Harriot Stanton Blatch and Theodore Stanton, *Elizabeth Cady Stanton as Revealed in Her Letters, Diaries & Reminiscences*, Vol I. (New York: Harper & Brothers, 1922), p. 66.

corresponding plaster patch in the ceiling above. The missing north partition wall was defined by a similar floor shadow that was also found to line up with a gap in the old baseboards at the west wall. Remnants of shelf-support brackets were further evidence of a closet enclosure at the northwest corner of the room.

Ceiling

The ceiling was plastered. It was composed of a circa-1840 plaster on circa-1835 circular-sawn lath similar to the walls. This ceiling survived in 1982 beneath a later application of textured plaster.

Baseboards

The baseboards in Room 201 were plain boards with no moldings that measured about 6 1/2 inches high. They are believed to have been installed before the room was originally plastered and have been dated circa 1830.

Original baseboards survived in their original locations in 1982 only at the exterior west and south walls. Removed in 1902-03 were the baseboards at the west end of the south wall, within the closets at the north wall, and at the east and north partition walls. Some of these baseboards were reused at this time. Those that were identified as belonging to either Room 201 or Room 202, based on their style and paint, were cataloged as R010, R154, R156, R118, and R165. Most had been reused at the new north partition wall.

Doorways

Three doorways opened off Room 201. Access into the room was through a doorway in the east partition wall that connected Room 201 with Room 202. Two other doorways were located in the north partition wall and opened onto two closets, one on either side of the fireplace. All three historic doorways were missing by 1982, having been removed during the remodeling of 1902-03. Knowledge of their appearance was therefore based on the surviving physical evidence described below.

The existence of a doorway in the east partition wall was assumed because this would have been the only entrance into the room. Unfortunately, no evidence survived in 1982 to indicate exactly where in the wall the doorway had been located. Placement was therefore conjectured based on the logical location of a doorway before 1840 when an early stair hall existed to the southeast of Room 201. It is assumed that after the stairway was removed circa 1840, the doorway would have been retained in the far south end of the east wall. Although the doorway was removed in 1902-03, pieces reused during the remodeling were identified in 1982. These included the complete jamb (R104a,b,c), the complete architrave on the side facing Room 201 (R060a,b,c), and the door itself (R039). It was determined that these doorway elements had originally been located on the second story, based on the paint analysis and—in the case of the architraves—traces of wall paint and wallpaper. The architrave is plain except for a bead on the interior edge. It measures 4 inches wide by 1 1/8 inches thick. The door is of mortised construction with four panels. The door was hinged on the south side of the architrave in Room 201 and opened into the room. Although the hinges themselves are missing, mortises extant in the architrave indicate that they numbered two. Each hinge leaf measured 3 inches high and was attached with three vertically aligned screws. A reused

hinge fitting this description was found elsewhere in the house and cataloged as R069. Evidence of the door latch was found on the four-panel door in the form of paint shadows and infilled holes. These indicate that it had been a Norfolk latch, on the opposite side of the door from the doorknob installed in 1902-03. The lift-bar portion of the latch was on the side of the door facing Room 201.

The closet doorway on the west side of the fireplace was clearly documented by a floor shadow that showed both the missing partition wall and the threshold for the doorway. This doorway was located approximately 1 foot 3 inches from the west wall and measured 2 feet 7 inches wide, according to the floor evidence. Reused doorway woodwork that was thought likely to have come from this doorway were a complete jamb (R105a, b, and c) and two pieces of an architrave (R103a and b) from the interior side of the closet. The architrave is plain except for a single bead along the interior edge. It measures 4 inches wide by seven-eighths of an inch thick. The door itself is assumed to have opened into the room due to space restrictions within the closet. It is not known which side of the doorway was hinged. The door is assumed to have had four panels similar to reused door R039.

The closet doorway on the east side of the fireplace was also documented by a floor shadow and reused fragments of woodwork. The doorway opening here appears to have been smaller than the opening for the west closet, because the closet itself was smaller. Reused woodwork that may have come from this doorway included jamb pieces (R179 - west side; R191 and R192 - east side; and R183 - header), and two pieces of architrave (R159 - west side complete; and R016 - lower east side fragment). The architrave pieces have a simple bead detail on the inner edge and measure 4 inches wide by 1 1/8 inches thick. A mortise for a hinge in R016, the lower west side architrave, is evidence that the door opened into the room. The door is assumed to have had four panels similar to reused door R039.

Windows

Three windows provided natural light to the room: two in the west wall and one in the south wall. All three windows are documented by the earliest exterior photograph of the house, dated circa 1900. Those in the west elevation are covered by shutters in the photograph, but the window in the south elevation is seen to have had nine-over-six window sashes. Except for the sashes, which were replaced in 1902-03, the windows survived intact in 1982. Original interior woodwork dating to circa 1835 included the architraves, the window stools, the window aprons, the window-stop headers, and the right window stop in the west wall's north window. In addition, evidence of Merriman-type window springs that held the bottom sash in place was found in the right-side frame of all three windows. A portion of the spring hardware was still held in place with the original blunt-end screws in the west wall's south window. The hardware had been removed from the two other windows, but surviving mortises in the window frames attest to their existence.

Fireplace

A fireplace was located in the center of the north wall. It served the vital function of heating the room during Stanton's day. The fireplace and its chimney were missing by 1982, having been removed in 1902-03. Physical evidence for this feature was discovered in 1982 and is described below.

The first indication that something had existed at the north end of the room were large patches in the floor, the north wall, and the ceiling. Removal of the floor and ceiling patches revealed the framing for the fireplace hearth and the interior chimney stack. These were located immediately above the fireplace and chimney on the first story in Room 101. It is assumed that both the hearth and the chimney stack were constructed using bricks, based on fragments of bricks found on the first story in the cavities of the exterior north wall. No trace was found of the mantel, which is believed to have been installed circa 1835 along with the other woodwork in the room. The only clues as to the appearance of the mantel were the surviving circa-1840 mantel in Room 101 and the fragments of the circa-1837 mantel in Room 104. It was probably made of wood and neoclassical in design with side pilasters and a shelf. Its location on the second story also suggests that the design was a simple one, judging from the existing plain baseboards and architraves.

Closet Shelves

Storage space was provided in the northwest closet by built-in shelves. Two shelves were on the east wall and six shelves on the west wall of the closet. The shelves were supported by plain strips of wood that were nailed to the north, and presumably to the south, walls. The supports existed by circa 1840, at which time the walls were plastered with the supports in place. The shelves were missing by 1982, having been removed along with the east and south partition walls in 1902-03. The physical evidence that remained is described below.

All evidence was preserved at the north wall, which retained much of its early circa-1840 plaster. Here two shelf supports survived intact for the east-wall shelves. Each support measures 1 inch high by 1 foot 1/2 inches long. The absence of nails or nail holes in the tops of the supports suggests that the shelves simply rested on top of the supports. All that remained of the west-wall shelves were the ghosts of the shelf supports in the north wall. The supports themselves were missing, but their locations were clearly defined by six gaps in the plaster identical in size to the existing supports to the east.

Also located in the northwest closet were boards that circled the closet at a height of about 6 feet. These were installed on top of the plaster and may have been used to attach clothes hooks. One section of the board survived at the north wall in 1982. It measures 4 3/8 inches high by 1 inch thick. Missing in 1982 were the corresponding east and west boards, whose shadows were visible on the north board. Exactly when these boards were installed is not known, although it was probably sometime after 1840, based on their placement on top of the plaster.

Finishes

No Stanton-period finishes were exposed to view in 1982. However, evidence of historic paints was found beneath later layers of paint, and early wallpapers were located in the adjacent room, Room 202. Details are provided below.

The floor was most likely painted with a lead-based oil paint according to the paint analysis. This early paint was a mustard-yellow color, color-matched to Munsell 2.5Y 7/6. The samples were obtained from two protected areas of the floor: one within the former northwest closet (P105), the other along the south perimeter of the room (P106).

The walls are believed to have been wallpapered during Stanton's day. No samples of Stanton-period wallpaper were found in Room 201 during the architectural investigation; however, multiple layers of wallpaper were found preserved in Room 202, behind a chimney built in 1903. Common practice of the day would suggest that Room 201 was also finished with wallpaper. The absence of wallpaper remains could be explained if the papers were stripped from the walls at a later date. The wallpapers in Room 202 included two papers that may have been applied by Elizabeth Cady Stanton between the years 1847-62. The first paper of probable Stanton vintage represents the second papering of the room. This paper, dated circa 1847, is a block-printed foliate design in colors of green, gray, and burgundy. The second paper, dated circa 1850s, is a machine-printed geometric design in colors of brown, beige, and burgundy. It was embellished with a green flocked border, a small fragment of which was found preserved near the ceiling. The border is identical in coloring to another flocked border used in the house about this same time in the adjacent stair hall, Room 203.

The ceiling was probably finished with a white calcimine paint, although no evidence survived on the ceiling in Room 201. However, multiple layers of white calcimine paint were found on the circa-1840 plaster in the adjacent room, Room 202. It is assumed that the ceilings of both rooms were treated in a similar manner.

The woodwork was painted with a white-color lead-based paint. This was determined from the analysis of paint on original circa-1835 woodwork in Room 201. The paint was color-matched to Munsell 5Y 9/1.

Room 202

Location and Size

Room 202 was the back room on the second story in the main part of the house. It was one of two rooms—Rooms 201 and 202—that were roughly equal in size and adjacent to one another. Room 202 measured approximately 17 feet 2 inches long by 13 feet 7 inches wide. Access to Room 202 was from the main stair hall to the south, Room 203.

Use and Name

Room 202 was probably a bedroom, given its location on the second story. It is also thought likely that Rooms 202 and 201 were a suite of rooms used by Elizabeth Cady and Henry B. Stanton. Possibly it was these rooms to which Mrs. Stanton referred when she wrote in 1856 after the birth of her second daughter, "I pace up and down these two chambers of mine like a caged lioness."²⁴

Floor

The floor was composed of floorboards that measured between 7 1/2 and 14 inches wide. A large patch, also composed of wide floorboards, existed in the room by Stanton's time. This patch covered over an opening in the floor for an early stairway that was removed circa 1840.

²⁴ Blatch and Stanton, p. 66.

Most of the floor and the circa-1840 floor patch survived in 1982. However, some of the original floorboards were missing along with the west end of the circa-1840 floor patch, due to another stairway opening installed in 1902-03. This north-south opening existed in 1982 and measured 2 feet 9 inches wide by 7 feet 5 inches long.

Walls

Room 202 was enclosed by three exterior walls and one interior partition wall during Stanton's time. The exterior walls were the north, east, and south walls of the main house. One partition wall divided Room 202 from Room 201 and served as the west wall of the room. All of the walls were plastered on circular-sawn lath held with machine-cut nails. The plaster was a lime and sand type with a hair binder. The walls appear to have been replastered on original lath before 1847; the lath has been dated circa 1835 and the plaster circa 1840. Missing by 1847 was a middle east-west partition wall that is believed to have been removed circa 1840 at the same time as the early stairway. All that marked its location were paint lines on the original east baseboard.

Three of the four Stanton-period walls survived in altered condition in 1982. These were the exterior north, east, and south walls. The walls were covered by plasterboard beneath which were preserved the lath and some plaster keys. Walls with their plaster and wallpaper intact were preserved in two locations: at the south wall behind a chimney, and at the north wall behind a partition wall, both installed in 1902-03. In addition, sheets of plaster with attached wallpaper were discarded in 1902-03 beneath the front porch.

Missing from the room by 1982 was the historic west partition wall that divided Room 202 from Room 201. It had been replaced in 1902-03 by a new wall located approximately 4 feet to the east of the old wall to make room for a new staircase and hallway. Evidence of the missing wall included a dark shadow on the floor that corresponded with a long, narrow, north-south patch in the plaster ceiling. Analysis of the plaster patch confirmed that it had been applied in 1902-03. The historic partition wall had been located approximately 12 feet from the exterior east wall of the room.

Ceiling

The ceiling was plastered on sawn lath held with machine-cut nails. Similar to the walls, the lath has been dated circa 1837 and the plaster circa 1840. Most of the original plaster ceiling survived in situ in 1982 beneath a later plasterboard ceiling. A hatch to the attic existed in the ceiling before 1840, based on an examination of the ceiling framing from the attic side. This small opening (3 feet by 2 feet 9 inches) had been located next to the exterior east wall, but it was covered over with lath and plaster circa 1840.

Baseboards

The baseboards were plain boards with no moldings. Two sizes existed in Room 202: one 6 1/4 inches high, the other 7 1/2 inches high. Both are thought to have been installed circa 1835. The difference in sizes has been attributed to the fact that Room 202 was at one time two separate rooms, one with low baseboards and the other with high baseboards. The low baseboards were in the north room and the high baseboards in the south stair hall. These baseboards were retained circa 1840 when the stairway and partition were removed to make one large room.

Some of the original baseboards survived in their original locations in 1982. These were at the south half of the east wall, the east half of the south wall, and at the east end of the north wall. Most of the missing baseboards had been removed during the remodeling of 1902-03. Some low baseboards were reused at this time, and were cataloged in 1982 as R010, R154, R156, R158, and R165. It was not possible, however, to differentiate the reused baseboards from Room 202 with those from Room 201 due to similarities in size and paint finishes.

Doorways

Two doorways opened off Room 202: one in the south wall, the other in the west wall. The south doorway was the primary entrance into the room off the stair hall, Room 203. It appears to have been an original circa-1830 window opening that was enlarged to a doorway when the south wing was appended circa 1837. The west doorway was the only entrance into the front chamber, Room 201. It is believed to have been installed circa 1835 when the second story was finished. Both doorways were missing in 1982, having been removed in 1902-03. The remaining physical evidence that was used in 1982 to reconstruct their appearance is described in detail below.

The south doorway had been covered by a hallway closet in 1902-03. Removal of this closet revealed evidence that a doorway had been located here. This included two wall studs added in 1902-03, a beveled finish in the circa-1840 plaster on what had been the left/east side of the doorway opening, and nail holes in the wall framing for the missing jambs and architrave. Portions of the jambs and architrave were identified in 1982 that had been reused within the house in 1902-03. Confirmation that the woodwork had come from this doorway was obtained by aligning nail holes in the woodwork with nail holes in the framing to which it had been attached. The reused woodwork included the complete jambs (R075a,b,c), the complete east-side architrave (R058), the complete west-side architrave (R180), a section of the architrave header (R195), and the threshold (R076). The jambs were plain boards that measured 5 inches wide. The architrave was embellished with a plain bead molding on its interior edge. The side architraves measured 2 15/16 inches wide and the header architrave 2 11/16 inches wide. Their narrow width, early paint layers, and unused nail holes suggest that the architraves were reused here at an early date—most likely circa 1840. The door was on the Room-202 side of the doorway. It was hung from two hinges attached to the east architrave, based on two hinge mortises in that element, and a patch in place of the latch in the west architrave.

The west doorway had been completely removed along with the entire west partition wall in 1902-03. That a doorway existed at all is certain because there was no other access into the front chamber, Room 201. Exactly where in the wall it was located is conjectural based on the circa-1830 placement of the stair hall in Room 202. This early layout makes a doorway in the south side of the west partition a plausible arrangement. As explained for the Room-201 side of the doorway, the complete jamb was located in 1982, along with evidence that the door had opened into Room 201. Also found in 1982 was the complete architrave, which is believed to have been removed from the Room-202 side of the doorway in 1902-03. It was cataloged as R055a, b, and c. The woodwork is 4 inches wide, seven-eighths of an inch thick, and features a bead molding on its interior edge.

Windows

Two windows were in Room 202 in the east wall. The openings and interior framework existed in 1982. Replaced sometime in the 1940s were the architraves, the window stops, and the window sashes. The windows may have been original to the circa-1830 construction of the main

house. Certainly they existed by 1835, based on the lath that was installed around them at that time. This lath, minus most of its plaster, survived at the east wall in 1982. No physical evidence of the historic woodwork or the window sashes was found. It is presumed that the woodwork and sashes would have been similar in design to those of the windows in Room 201. Here the treatment was simple, with plain-board architraves and nine-over-six sashes.

The placement of the windows within the east wall seems odd, being widely separated and located at the far ends of the wall. One would expect the spacing to have been more like the windows in the west wall of Room 201. The most feasible explanation seems to be that the windows were installed when Room 202 was two rooms—a stair hall and a north room. The windows were not altered when the middle partition wall was removed circa 1840, thus leaving what appears to be an unusual arrangement.

Stairway

No stairway existed in Room 202 during Stanton's time. However, a patch in the floor clearly defined where an earlier stairwell had been located. The patch was located in the south end of the room, was rectangular in shape, and east-west in orientation. It was composed of wide boards similar to the old floorboards in the room. The former stairway is believed to have been original—circa 1830—and to have been removed during the remodeling of circa 1840. The floor patch was most likely covered over during the historic period with a floor covering such as a carpet and/or furniture. The east half of the patch survived in 1982; the west half had been removed in 1902-03 for a new stairway having a north-south orientation.

Fireplace

There was no fireplace in Room 202, nor was there a chimney nearby that could have vented a stovepipe. We can only guess that it was warmed indirectly from the fireplace in Room 201.

Finishes

It was determined from the paint and wallpaper analysis that all woodwork in the room was painted with lead-based oil paint, the plaster walls were papered, and the plaster ceiling was finished with a calcimine paint. The floor was painted a yellow color (Munsell 2.5Y 7/6), and all other woodwork and the ceiling were painted a white color (5Y 9/1). Samples of early wallpaper were found at the south wall behind a chimney and at the north wall behind a partition wall, both installed in 1902-03. Plaster bearing wallpaper was also found beneath the front porch where it had been discarded in 1902-03. For a more complete description of the early wallpapers, see the "Finishes" section for Room 201.

Room 203

Location and Size

Room 203 was located on the second story at the north end of the south wing. It measured approximately 16 feet long by 7 feet 10 inches wide.

Use and Name

Room 203 functioned as a stair hall during the time the Stanton family lived in the house. No historical records have been identified that mention this room or the name by which it was known.

Floor

The hall floor was located on the west side of the room. Only the west side of this room had a floor: the east side was the stairwell for the staircase created here circa 1840. One interesting feature of the historic floor was that it cantilevered over the lower stairway. The reason for this structural treatment was presumably to enable access to the doorway in the center of the south wall. The floorboards varied in size, ranging from 5 1/2 to 13 inches wide.

The floor was considerably altered from its historic appearance by 1982 due to changes made in 1902-03. These included raising the entire floor approximately 12 inches, closing the stairwell opening, and removing and reinstalling the old floorboards. The historic configuration was determined by examining the floor's structural framing which included the 12 original floor joists. Of the 12 joists, it was found that the six to the west were intact, while the six to the east had been cut back for the stairwell. In addition, evidence was found of a railing at the perimeter of the stairwell opening. This is described in more detail in the section entitled "Stairway." Most of the floorboards existed but not in their original locations, based on the presence of former nail holes and the later wire nails that held them in place by 1982.

Walls

Four walls enclosed Room 203: an exterior wall to the west, the former exterior wall of the main house to the north, an exterior wall to the east, and an interior partition wall to the south. The walls were not of even height due to the low sloping ceiling that followed the line of the roof. All four walls were finished with plaster on wood lath. The plaster was a lime and sand type with a hair binder. The lath was split and held with machine-cut nails. Both are believed to have been applied circa 1837 when the south wing was joined to the main house.

Three of the original four walls—the west, north, and east—survived in 1982 in altered condition. The most dramatic changes were made in 1902-03. These involved heightening the walls by raising the roof, removing most of the lath and plaster, creating a new opening in the north wall for a new hall, removing the south partition wall, and installing new partitions to make a hall to the west and a bathroom to the east. The old lath and plaster survived in one location only: on the lower east side of the north wall. Although the plaster itself was missing from the remaining walls, evidence of it could be seen in the form of lath nails and white plaster marks. The absence of plaster marks was used to locate the missing south partition wall. This was a 3-inch "shadow" on the east and west roof girts. Not surprisingly, the placement of the south wall lined up exactly with the evidence for a corresponding wall on the first story.

Ceiling

The ceiling was low and sloping, following the lines of the roof. Only in the center near the peak did it level out to a narrow flat area. The ceiling, similar to the walls, was finished with plaster

on wood lath. The plaster is assumed to have been the same lime and sand type that was used on the walls. The lath was split and held with machine-cut nails. Both are believed to have been applied circa 1837.

The ceiling was considerably altered by 1982, having been stripped of its plaster and heightened in 1902-03. Luckily, however, the entire roof structure had been raised in situ, preserving the evidence of the old ceiling. This evidence included lath nails and white plaster stains on the undersides of the roof rafters. Similar marks were found on the few remaining horizontal boards that were located near the roof peak and framed the flat portion of the ceiling.

Baseboards

The baseboards were similar in design to those in Room 103, with a simple bead molding along the upper edge. These baseboards measured approximately 6 1/2 inches high by 1 inch thick. They were not original to the room, but appear to have been installed circa 1840, at the same time as the stairway to the east. This is based on the paint analysis and the fact that all other baseboards on the second story were plain with no molded details.

No baseboards remained in place in 1982, all having been removed in 1902-03 when the floor was raised. Fortunately, some of the baseboards were reused at this time, and were found during the architectural investigation in various locations throughout the house. There were given catalog numbers R002, R097, R098, and R176.

Doorways

Two doorways opened off Room 203: one in the north wall and one in the south wall. The north doorway led to Room 202 in the main section of the house. It was located one step up from Room 203, due to the difference in floor heights between the south wing and the main house. The south doorway led to Room 204 in the south wing. Both doorways were missing by 1982, having been removed in 1902-03. The physical evidence used to determine their appearance is described below.

The north doorway was removed and covered with plaster and wood wainscot when this area was converted to a bathroom in 1902-03. Evidence of the doorway was found when the wainscot on the lower wall was removed. This revealed two wall studs installed in 1902-03, a small section of original circa-1837 plaster with a straight vertical edge on the east side of the former opening, and white plaster stains that end in a vertical line on the center post to the west side of the opening. It was clear from this evidence that a doorway had existed here when the room was first plastered circa 1837. Pieces of the doorway woodwork were also found during the architectural investigation to have been removed and reused in 1902-03. These included the complete jamb and threshold, described in the "Doorways" section for Room 201, and the architrave (R073) from the east side of the doorway in Room 203. Confirmation that the architrave came from this doorway was obtained by holding the woodwork in place and noting that the nail holes aligned. The architrave measures 4 inches wide by 1 1/4 inches thick and has a simple bead on its interior side. Several clues suggest that the architrave was reused here when the staircase was installed circa 1840. These include the bead molding, early paint layers, and two early patches in place of two hinges. The door was located on the opposite side of the doorway by circa 1840, according to evidence found in Room 202.

The south doorway was located in the south partition wall. It was removed in 1902-03 at the same time as the wall. That the doorway existed at all was assumed based on the fact that the only other entrance into Room 204 was the steep stairway in the southeast closet of Room 104. The exact placement of the doorway within the wall could not be determined due to the lack of physical evidence. While other missing doorways in the house were located based on painted outlines on the floor of thresholds and architraves, no such information was available here due to the rearrangement of the floorboards in 1902-03. However, the doorway was probably in the exact center of the wall. Such an arrangement would have taken advantage of the full height of the ceiling in the center of the room. It also explains the need for extending the floor above the lower stairway near the center of the south wall. Pieces of woodwork that may have been the doorway architrave were found in 1982 reused at a small attic doorway. They were cataloged as R067a, b, and c, and were noted to be plain boards measuring 3 1/4 inches wide by 1 inch thick. That they had originated in Room 203 was determined based on the paint analysis and scraps of Room-203 wallpaper that were adhered to the edges of the boards.

Windows

There were no windows in Room 203. It was not a completely dark room, however, due to the presence of a window in the east wall of the stairway. This window is described in detail in the “Windows” discussion for Room 103.

Stairway

A major feature of Room 203 was the stairway to the first story on the east side of the room. This stairway was not an original feature, and is believed to have been installed circa 1840. The stairway itself is described in detail in the “Stairway” section of Room 103. A description of the stairwell opening may be found in the “Floor” section for Room 203. Another component of the stairway was a railing that bounded the stairwell and functioned as a safety barrier. This railing was missing in 1982, having been removed at the same time as the stairway in 1902-03.

The railing was composed of three posts (one being the upper newel), three lengths of handrail, and numerous balusters. The locations of the upper newel and the first post were based on the presence of two mortises in the sixth floor joist from the west. The third post was attached to the end of the eighth floor joist from the west, which had been cut back circa 1840. Many of the railing pieces were found to have been reused in 1902-03 in the new stair railing, or stored loose in the house. These included all three posts (R046, R049, and R050a), two lengths of handrail (R048 and R050b), and 14 balusters (R047b).

Fireplace

There was no fireplace in Room 203.

Finishes

Discovering how Room 203 was finished during Stanton’s day was a challenge because the room had been completely disassembled in 1902-03. Luckily, it was found that a small section of circa-1837 plaster with attached wallpapers had survived at the north wall beneath later materials. Also, more plaster and wallpaper had been discarded beneath the front porch, and numerous pieces

of painted woodwork had been reused throughout the house in 1902-03. Analysis of the paint and wallpaper determined that Room 203 had been finished in a manner identical to Room 103, except for the floor, which was painted with a yellow oil-base lead paint (Munsell 2.5Y 7/6). For a detailed description of the other finishes, see the "Finishes" section for Room 103.

Room 204

Location and Size

Room 204 was the large south room on the second story of the south wing. It was located immediately above Room 104 and was connected to it by means of a steep staircase. Primary access into the room, however, was through Room 103—the stair hall—to the north. Room 204 measured approximately 16 feet long by 15 feet 8 inches wide. It seemed smaller, however, due to the sloped ceiling on the east and west sides of the room.

Use and Name

No specific references were found about this room in the historical documentation. Being large, it was probably used as a bedroom by the Stantons' sons, who numbered four by 1859: Daniel, Henry, Gerrit, and Theodore. Gerrit later recalled that the house "had many bedrooms."²⁵ In addition, Elizabeth Cady Stanton wrote to her son Daniel in 1852, "the boys are upstairs in bed and asleep."²⁶

Floor

The floor was composed of wide floorboards that measured 5 1/2 to 13 inches wide. An opening existed in the southeast corner of the floor for a stairway to the first story.

Neither the floorboards nor the stairway opening survived in their historic locations in 1982, both having been altered in 1902-03. Changes made to the floor included raising the level of the floor approximately 12 inches, removing all the floorboards and reinstalling them in new locations, and infilling the stairway and chimney openings. The historic level of the floor and the configuration of the stairway and chimney openings were determined by studying the structural framing of the floor. The antiquity of the floorboards was verified by the early layers of paint identified by the paint analysis and the presence of former nail holes. The original location of only one floorboard was identified in 1982. This board, cataloged as R190, came from the north side of the southeast stairway opening.

Walls

Four walls enclosed Room 204: three exterior walls on the east, south, and west sides, and an interior wall on the north side. These walls were irregular in height due to the low sloping ceiling

²⁵ Gerrit Smith Stanton, "How Aged Housekeeper Gave Her All to Cause of Woman's Suffrage" (ca.-1930s news article, Seneca Falls Historical Society).

²⁶ Blatch and Stanton, Vol. II, p. 42.

on the east and west sides of the room. The walls were finished with plaster on wood lath. The plaster was a lime type with a hair binder. The lath was split and held with machine-cut nails. Both are believed to have been applied circa 1837.

Little remained of the historic walls in 1982 due to the extensive remodeling of 1902-03. Alterations made at that time included removing the north partition wall, removing the lath and plaster, raising the height of the floor, raising the height of the walls/ceiling, and installing new partition walls to make a hallway and a closet at the north end of the room. It was possible to determine the historic configuration of the walls by identifying the structural elements added in 1902-03, and by studying the earliest exterior photograph of the house, dated circa 1900. Although no lath or plaster remained in 1982, it was determined to have been the same as the lath and plaster in Room 203, based on the surviving lath nails and fragments of plaster found in the wall cavities of Room 104. The missing north partition wall was located based on a “shadow” of the wall left on the east and west roof girts. This shadow was caused by the absence of white plaster stains where the wall had abutted and covered the girts.

Ceiling

Like Room 203, the ceiling in Room 204 was low and sloping on the east and west sides except for a narrow flat area at the center. It, too, was finished with lath and plaster similar to the walls.

The ceiling was considerably altered by 1982, having been stripped of its plaster and heightened in 1902-03. For a description of the surviving evidence, see the “Ceiling” section for Room 203.

Baseboards

The baseboards were plain boards that measured 5 3/4 to 6 inches high by seven-eighths to 1 inch thick. None of the baseboards remained in their original locations in 1982 because they had been removed in 1902-03. Luckily, several lengths were reused throughout the house and were identified during the architectural investigation. These were cataloged as R061, R153, R160, R164, R166, R171, and R172.

Doorways

There was only one doorway in Room 204, located in the north partition wall. This doorway was the primary access into the room off the main stair hall (Room 203). Logic suggests that the doorway was centered in the wall to take advantage of the full height of the ceiling.

The doorway was missing by 1982, having been removed along with the north wall in 1902-03. Only two small fragments of what appears to be the doorway architrave were found in reused locations in 1982; these were cataloged as R036 and R037. These architrave fragments are plain boards that measure 3 1/4 inches wide by 1 inch thick. No evidence was found of the door, although it is assumed that one existed. It is not known on which side of the doorway the door was hung. The Room-204 side seems most likely, based on the absence of obstructions here.

Windows

Two windows were located in the south wall of Room 204. They were fitted with six-over-six sashes and Merriman-type window spring hardware. The architraves were probably plain boards similar to those of the north doorway.

The two window openings existed in 1982 but in altered condition due to changes made during the remodeling of 1902-03. These changes included removing the frames, enlarging the openings, and installing new sashes and woodwork. Luckily, the appearance of the windows was documented prior to the renovation by the exterior photograph of circa 1900. This view shows both windows fitted with six-over-six sashes. One of these windows was identified during the architectural investigation as having been reused in the new second-story bathroom in 1902-03. The frame was cataloged as R014 and the two six-pane sashes as R013. A mortise cut-out in one side of the frame is evidence of a Merriman-type window spring that functioned to hold the bottom sash in an open position. The antiquity of the sash was verified by the multiple layers of early paint on the exterior side, as identified by the paint analysis.

Stairway

A stairway to the first story was located in the southeast corner of the room. Stairway components within Room 204 were the opening in the floor and presumably a railing on the north side of the opening.

The stairway was missing by 1982, having been removed and its stairwell floored over in 1902-03. Evidence for the stairway is described in detail in the "Stairway" section for Room 104. In Room 204, one floorboard was identified in 1982 as having been reused in 1902-03 from the immediate north side of the stairway opening. This board was cataloged as R190. No physical evidence was found for a protective railing on the north side of the stairway opening. This is not to say that a railing did not exist, but rather that no trace of it survived. Surely a railing would have been a necessary safety feature in the Stanton household, which at one time included seven children.

Fireplace

It appears that there was no fireplace in Room 204 even though a chimney stack projected into the room at the south wall. Heating of the room may have been accomplished in one of two ways. First, a fire in Room 104 below may have generated sufficient heat in the chimney to warm Room 204. Second, a cast-iron stove may have been installed in Room 204 and vented to the chimney stack.

The chimney stack was missing by 1982, having been removed in 1902-03. That a chimney had existed at the south wall was determined based on the exterior photograph of circa 1900 and the structural framing of the floor. How this chimney was finished within the room is not known. We can only guess that the bricks were plastered similar to the walls and ceiling. No framing existed for a hearth, suggesting that there was no fireplace on the second story.

Finishes

Of all the rooms in the house that survived in 1982, Room 204 had one of the most austere finishes. All surfaces were painted: the floor and woodwork with a lead-based oil paint and the walls and ceiling with a calcimine paint. It was determined based on the paint analysis that the floor was yellow (Munsell 2.5Y 7/6) and all other features were a white color (Munsell 5Y 9/1).

Identifying the finishes for Room 204 was a challenge due to the fact that the room had been completely disassembled in 1902-03. Of the original woodwork, only the floorboards survived, but in rearranged locations. The paint analysis determined that the floorboards had retained their early layers of paint. Other woodwork, such as painted baseboards and fragments of the doorway architrave, were found in reuse locations throughout the house. No plaster remained on either the walls or the ceiling. Plaster was found, however, to have fallen into the first-story wall cavities in Room 204. That this plaster was from Room 204 and not Room 104 was determined based on a characteristic layer of light blue calcimine paint that also overlapped into the upper edges of the baseboards. No samples of ceiling plaster from Room 204 were identified in the debris from the wall cavities. We can only guess that the ceiling was finished with a white calcimine paint similar to the ceilings of other rooms in the house.

POST-STANTON PERIOD (1862-1982)

Background

Many alterations were made to the Stanton House and site between the years 1862, when the Stanton family left Seneca Falls, and 1982, when the National Park Service acquired the property. These changes are presented here in chronological order.

Removal of the North Wing, Circa 1864

The Stanton House site appears to have been subdivided into several lots by 1864, according to the tax assessment records. This subdivision would have required the removal of the north wing of the Stanton House due to the placement of the north boundary line. The physical evidence verified that neither fire nor structural failure were a factor in the removal of this wing. It was initially thought possible that the small house on the adjacent north lot may have been the wing that had been simply moved next door circa 1864. This theory was later disproved by a physical examination of the house, which identified later structural materials such as circular-sawn framing and comparatively modern machine-cut nails.

Treatment of the north elevation of the Stanton House following removal of the north wing is suggested by the 1873 "Bird's Eye View of Seneca Falls, N.Y." (fig. 6). The elevation is partially obscured by the adjacent house to the north, but two features are seen: a doorway near the east end of the first story, and a window approximately centered on the second story. The number and type of openings shown is correct, based on architectural evidence, but their lateral placement seems erroneous. The doorway as shown would have been located in Room 102; this could not have been the case, since undisturbed baseboard and plaster dated circa 1840 exist in this location in Room 102. However, there was such a doorway farther west in the elevation, located in Room 101: it had been created circa 1840 to access the new north wing, and exposed circa 1864 when that wing was removed. The map of 1873 suggests that this former interior doorway was not closed up when the wing was removed, but rather converted to an exterior doorway.

Similarly, architectural evidence of a closed-up window was found in the second-story north wall, but near the east end.²⁷ The window could not have existed during the historic period, because the north wing would have partially covered it. It thus was probably added after the removal of the wing circa 1864. The date of its closure is unclear; it may have occurred during the major remodeling that took place in 1902-03.

New siding was required for the north elevation following the removal of the north wing. This siding was observed in 1982 to be narrower and thinner than the original circa-1830s siding. It was attached with machine-cut nails having sheared ends and shanks clasped for heading on the

²⁷ The evidence was found after the site drawings presented in Appendix H were made.

uncut sides. The first paint layer on this siding is red, according to the findings of the paint analysis. This dates the change of the exterior paint color from white to red as having occurred circa 1864.

First-Story Alterations, Circa 1880

Alterations and repairs were made to the house in the last quarter of the 19th century. This work included the closure of the north-elevation doorway shown in the bird's-eye view, which indicates the work was done after 1873. It could have happened as late as 1890, when George Boardman purchased the property from his father. The changes have therefore been dated circa 1880 for this report.

Most changes were identified as having been made in the double parlor of the main house—Rooms 101 and 102. Several changes were made to the doorways in Room 101. As previously mentioned, the exterior doorway in the north wall was completely closed at this time; the wide doorway in the east wall was reduced to a standard-size doorway; and a new doorway was created in at the east end of the south wall. Reused woodwork, lath, plaster, and woodwork were used to close the doorways in the north and east walls. Some of the encapsulated woodwork was been painted, which helped to date paint layers identified by the paint analysis. The lath used at this time was circular-sawn. The nails holding the lath were machine-cut with sheared ends and heads clasped for heading on their uncut sides. The plaster was found by the mortar analysis to be a characteristic mix of two parts lime to one part sand. The first wallpaper covering the newly patched walls was a mechanical wood-pulp paper printed with a design that was popular in the late-19th century. Old baseboards removed from Room 102 were used to patch in the areas of missing baseboard at the doorways. The woodwork in the room was grained at this time over a white base coat, making this the third graining of the room since circa 1840.

The work undertaken in Room 102 is less clear due to subsequent changes made in 1902-03. However, it appears from the remaining evidence that an east-west partition wall was installed. The only remaining evidence of the partition wall in 1982 was a floor-to-ceiling-length board that was reused in 1902-03 (R089). This board is finished with Room-102 wallpaper, border paper, and baseboard paint, and thus appears to have been part of the wall. The reason for partitioning the room appears to have been to install a stairway to the cellar on the south side. A patch in the floor, held with wire nails, is all that remains of the stairway. The woodwork in the room was painted a light gray color at this time.

Remodeling, 1902-03

Extensive alterations were made to the house early in the 19th century. Hugh Gilmore purchased the house from George Boardman in May 1900. Work on the house may have commenced in 1902, based on a higher tax assessment for that year. A newspaper fragment dated "1903," found in a cavity of the new brick chimney, is proof that construction continued through that year. Finally, in 1904, *"Grip's" Historical Souvenir of Seneca Falls, N.Y.* noted that Mrs. Stanton's former house had been "entirely remodeled."

The house as remodeled by Hugh Gilmore would not have been recognized by Elizabeth Cady Stanton. The changes are summarized below:

- all chimneys and fireplaces were removed;
- the front porch and east wing were removed and rebuilt;
- the south wing was heightened to two stories;
- the exterior siding was repaired and "fish-scale" shingles installed in the gable ends;
- doorway and window openings were altered;
- the old window sashes were replaced with new window sashes;
- new window shutters were installed;
- the interior layout was changed by removing old partition walls, adding new partition walls, removing the old stairway, and installing a new stairway;
- the old woodwork was replaced with new woodwork in some of the rooms;
- a second-story bathroom with plumbing was installed;
- a hot-air heating system was installed (note that one metal heat register was imprinted inside with "JOS. GEDDES ROCHESTER N.Y. SOLE MANF.G & PATENTEE - STERLING 8x12 PAT. SEPT. 16 1890");
- interior walls and ceilings were replastered and/or patched;
- the house was repainted, both inside and out; and
- wall and ceiling papers were hung.

Luckily, Hugh Gilmore was a frugal worker: much of the historic woodwork that he removed was reused somewhere within the house. New building materials were also used by Gilmore and included wire nails, circular-sawn lath, lime plaster made with a white quartz sand, and wall and ceiling papers made of mechanical wood-pulp paper. In addition, some new woodwork such as clapboards, sawn shingles, doors, and interior trim was installed. The exterior of the house was painted white, according to the paint analysis and the exterior photograph of 1904-05.

Shed Addition and Electrical Wiring, Circa 1910

The tax assessment for 32 Washington Street increased from \$700 in 1909 to \$850 in 1911. Two improvements that may have accounted for this increase were the building of a shed addition on the east side of the new east wing and/or the installation of an electrical system. The shed first appears in a post-card view (fig. 10) made after sometime after the renovations of 1902-03. Postulating that the ca.-1910 tax increase reflected the construction of the shed, the latter's presence on the post card is the main reason this view has been dated circa 1915. The shed was removed in the 1970s, but paint lines found in 1982 indicate that this was an entry vestibule that was only half the width of the east wing.

The installation of electrical service is known to have occurred after 1902-03 and before 1921. That this took place after Hugh Gilmore's renovations was determined based on the absence of wires between the street and the house in the photograph of 1904-05. A pre-1921 date is based on a field inventory done in that year, which described 32 Washington Street as having the following

exterior equipment: "2-wire, #8 weather-proof copper-type wire, 110V service."²⁸ The earliest electrical equipment in the house was found to be the knob-and-tube type with white porcelain knob insulators. The early electrical meter and fuse boxes were located in the main house's cellar, at the west end of the north wall.

New Shop, 1919

The tax assessment rose from \$850 to \$900 in 1919. This increase may be accounted for by the addition of a "shop" in the assessment. This small building appears on the Sanborn map of 1925 (fig. 11), which calls it an "auto house/private garage." In 1919, however, the building may have housed Hugh Gilmore's meat shop.²⁹ It is probably the small gable-roof building seen to the right of the house in the photograph dated circa 1920s (fig. 12). Another reason for thinking that the building was constructed in 1919 is its absence in figure 10, the post-card view tentatively dated to circa 1915.

Exterior Painting, 1928

The exterior of the house was painted gray in 1928. This is based on the paint analysis and a mason jar filled with gray paint that was found in the cellar wrapped in a newspaper dated "1928." The extra paint had no doubt been saved to do touch-up work around the house. Paint analysis revealed that the house had been painted gray on two separate occasions. The earliest view showing the house tinted gray is the post-card view of circa 1915. Thus, 1928 probably represents the second time the house was painted gray, and the third time the house had been painted since the renovations of 1902-03 when the exterior was painted white.

Exterior Shingle Siding, Circa 1930s

Wood-shingle siding was applied over the existing board siding sometime after the exterior painting of 1928 and before a film clip dated 1948. Product labels affixed to the backs of some of the shingles identifies them as "Everlast Brand—Red Cedar Shingles—No. 1 Grade," made by "Forester-Hurndall Lumber Co. Ltd.," of "Vancouver, British Columbia—Canada." Other work done at this time included removing the window shutters and applying new trim to the existing doorway and window openings.

²⁸ Empire Gas & Electric Company, "Field Inventory, 1921," as relayed to Barbara Pearson by Mr. Cooley, Electrical Engineering Division, New York Gas & Electric Corporation, January 11, 1984.

²⁹ Corinne Guntzel, "History of the Stanton House" (typescript, Women's Rights NHP, June 1, 1982), p. 7.

Inside, new floor coverings were installed on top of the old floorboards in two rooms, according to evidence found in 1982. Newspapers were first laid on the floors, perhaps for insulation. In Room 204, the newspapers in the center of the room were dated July and August 1934. In Room 104, only one newspaper remained; this was dated May 1939.

Renovations, Circa 1948

Considerable work appears to have been undertaken by owner Stanley Burroughs in 1948, which was coincidentally the centennial anniversary of the Women's Rights Convention in Seneca Falls.

A short film made in that year shows the front porch in the process of being enclosed. This is the same porch that had replaced the original porch in 1902-03. Removed at this time were the porch columns, the railings, and the wide steps. Newly installed were windows, a door, new wood steps, a flared "Bungalow-style" skirt, and shingle siding. Electrical wiring, of the two-wire type but more modern than the extant knob-and-tube system within the house, was installed in the porch ceiling for a light. Finishing materials used inside the porch were matchboard siding and plasterboard.

Work was also undertaken inside the house, although the evidence is less conclusive that it was done precisely in 1948. Plasterboard was installed in Rooms 101, 103, 104, 202, and 203, and the second-story bathroom was remodeled. Also, the north-wall window in Room 202 was covered over by a new closet, and the east-wall windows were replaced with new windows.

The primary indication that this work was done in 1948 is the top layer of wallpaper that was covered over by the plasterboard in Room 202. The wallpaper is identical in style to a paper carried in a 1942 sample book by Montgomery Ward and Company. In addition, a product label was found attached to the new Andersen windows in Room 202 with a last patent date of "1932," indicating the windows were installed sometime after 1932.

More Renovations, Circa 1960s-70s

The last campaign of modern improvements was also undertaken by the Burroughs family before they sold the house in 1978.

A baseboard hot-water heating system replaced the existing 1902-03 hot-air heating system sometime in the 1960s. The old coal-fueled furnace was probably removed at this time, a concrete pad poured in the south wing's cellar, and the new gas-fueled furnace installed. Heating units with metal fins were placed in the rooms against the existing baseboards. Coincidental with the new heating system, narrow oak floorboards were installed over the existing floorboards in Rooms 102, 103, and 104. Printed on the undersides of the floorboards were the manufacturer's name, "Gromas Co.; Williamsport, PA," and the patent dates, "6-10-19, 9-1-25." Newspapers found beneath the oak floorboards in Rooms 103 and 104 were dated December 1962 and January 1963. Therefore,

this work was probably done in early 1963. Because gas service was hooked up in 1963, the gas kitchen stove in the 1903-03 kitchen wing may also have been installed at this time.

The work done in the 1970s was remembered by neighbor T.J. Casamassima, who helped Mr. Burroughs. The most recent coat of green paint on the exterior of the house and the interior of the porch was applied in the spring of 1972. Sometime thereafter and before 1978, the circa-1909 east-wing vestibule was replaced by a similar but wider structure that functioned as a back porch. Room 104 was partitioned and a new first-story bathroom installed in the southeast corner of the room. Also installed at this time were wall-to-wall carpeting in Rooms 101 and 104; wall paneling in Rooms 102, 201, and the second-story hallway; a drop ceiling in Room 101; and acoustical ceiling tiles in Room 102 and the second-story hallway. The fenestration was altered by replacing one of the south-elevation windows in the first story of the south wing with a smaller window. Similar small windows were also installed in the north and east elevations of the later east wing. Fiberglass insulation was placed between the floor joists in the attics and in some of the walls. Some new electrical wiring was also installed, such as for an outlet for a washing machine in the new east-wing back porch.

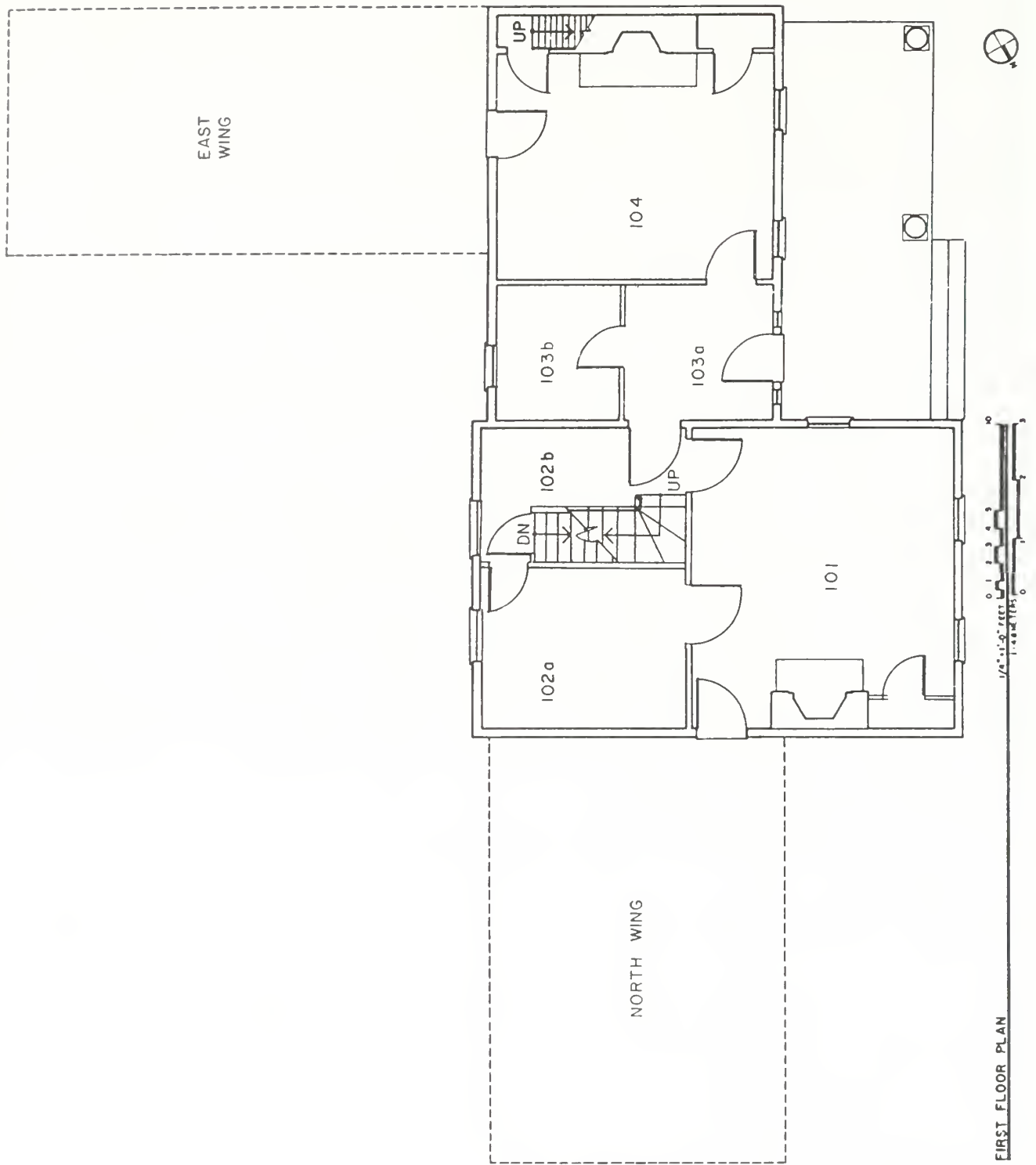

Figure 16. Conjectural first-floor plan of William Bayard's house, circa 1837.

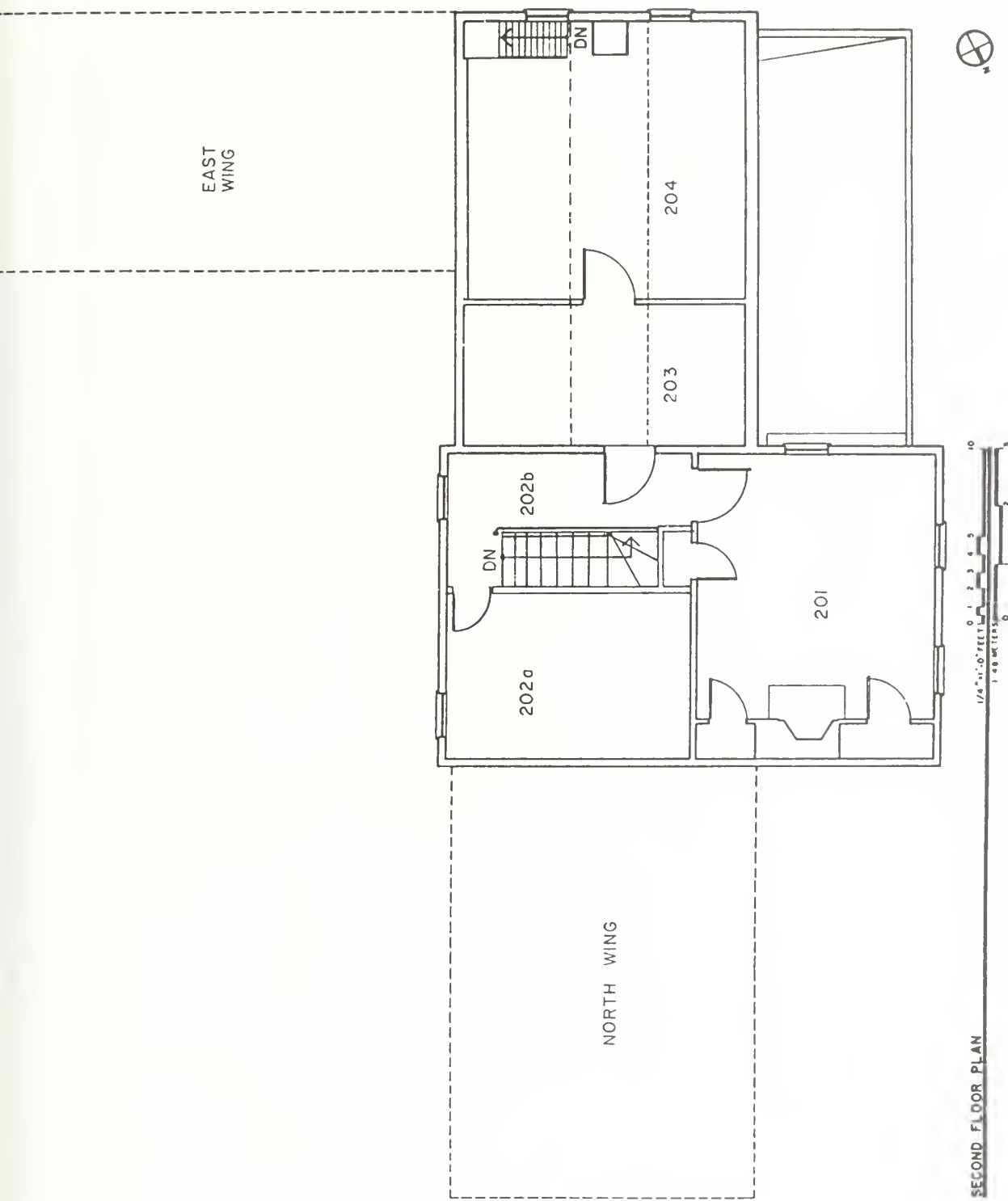

Figure 17. Conjectural second-floor plan of William Bayard's house, circa 1837.

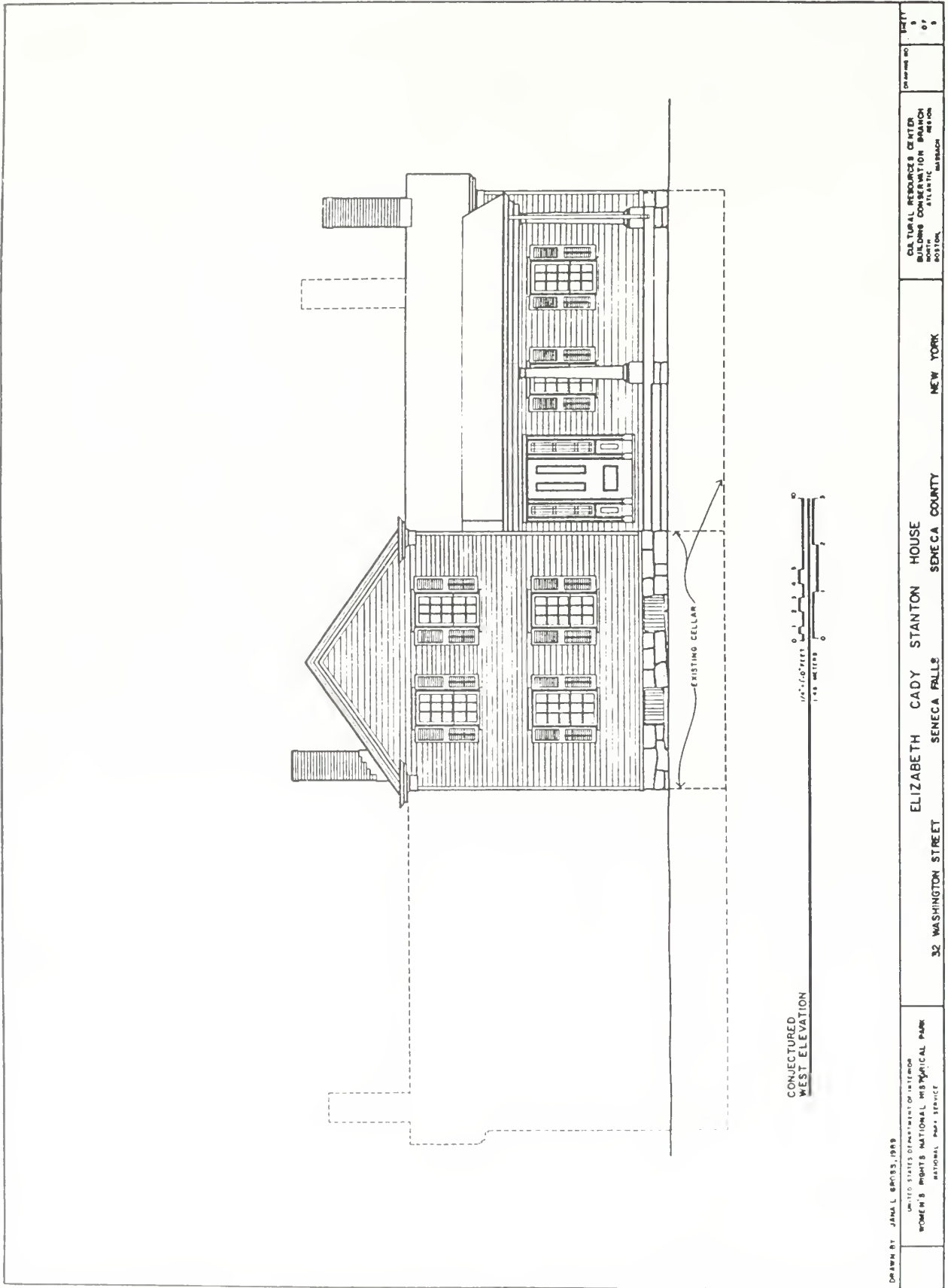
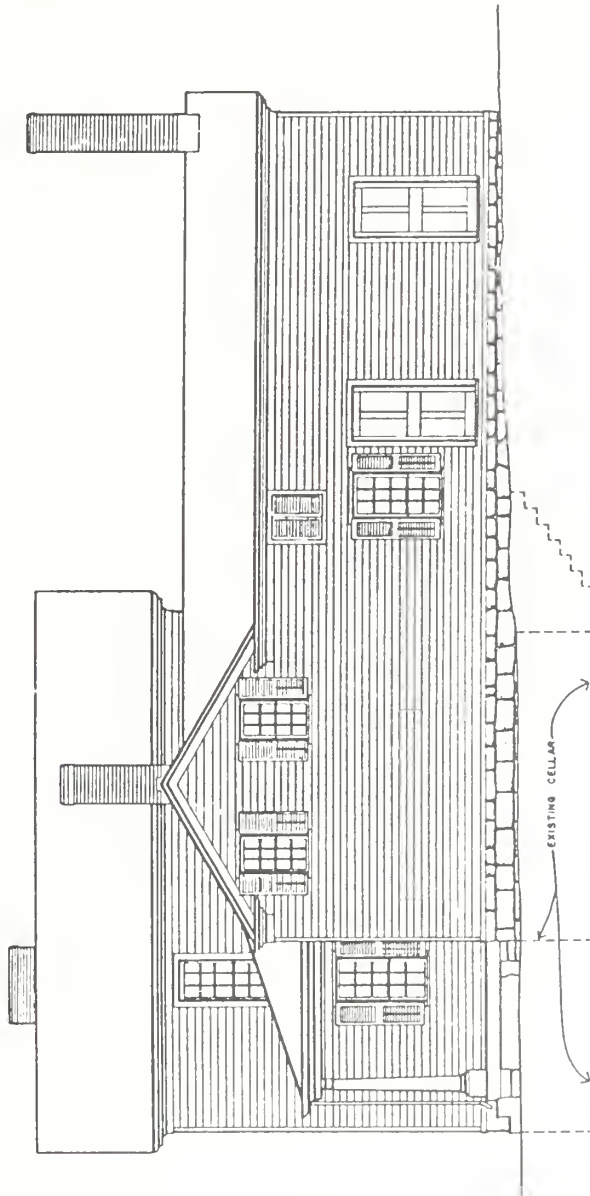

Figure 18. Stanton House: west elevation (conjectural view), circa 1847-62.



CONJECTURED SOUTH ELEVATION



DRAWN BY JANA L. MOSS, 1989 UNITED STATES DEPARTMENT OF INTERIOR WOMEN'S RIGHTS NATIONAL HISTORICAL MARK NATIONAL MONUMENT SERVICE	32 WASHINGTON STREET ELIZABETH CADY STANTON HOUSE SENECA COUNTY SENECA FALLS NEW YORK	CULTURAL RESOURCE CENTER BUILDING CONSTRUCTION SECTION NORTH ATLANTIC REGION BOSTON, MASSACHUSETTS DRAWING NO. 100-100-100 SHEET 4 OF 4
---	---	--

Figure 19. Stanton House: south elevation (conjectural view), circa 1847-62.

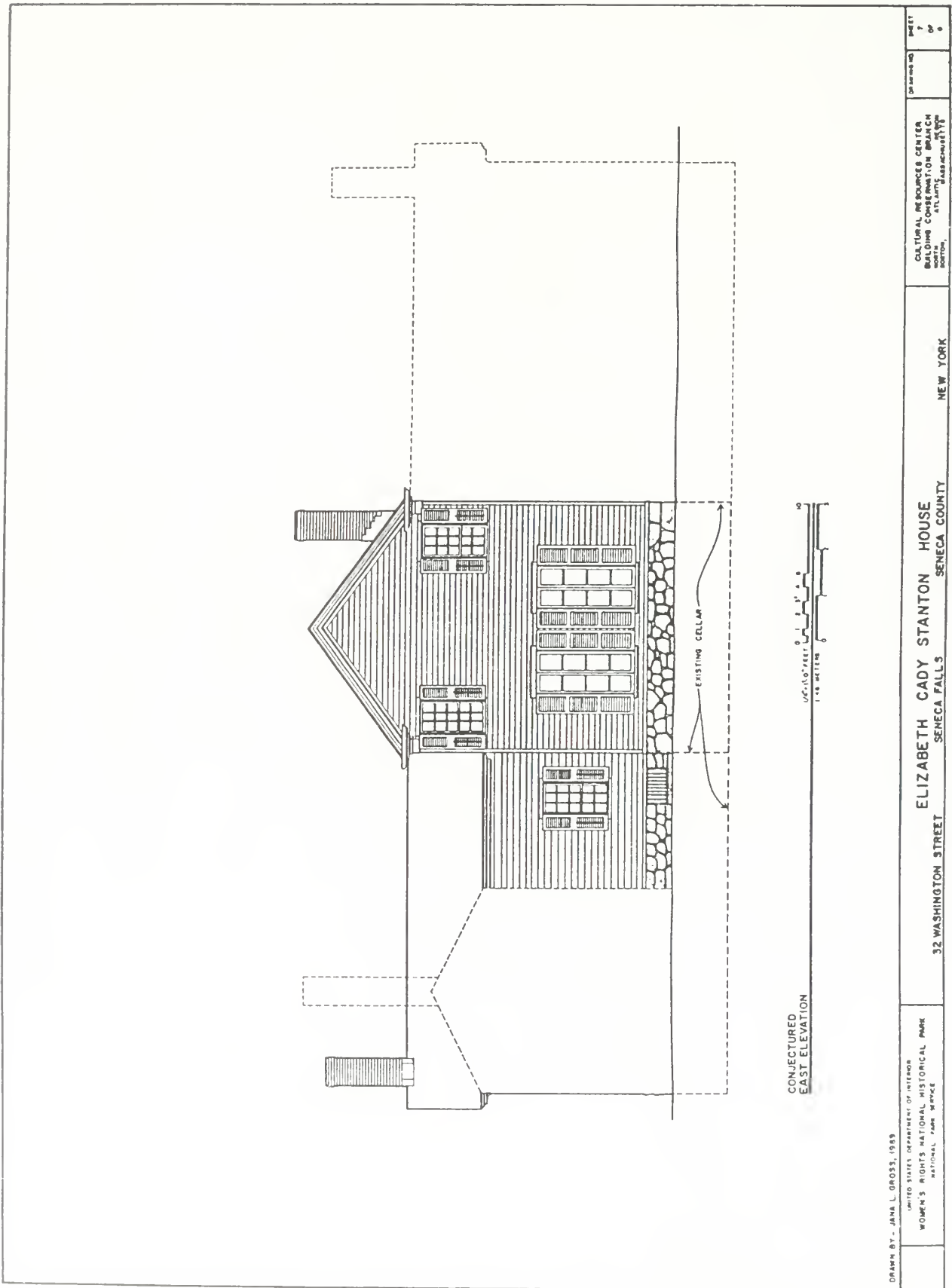
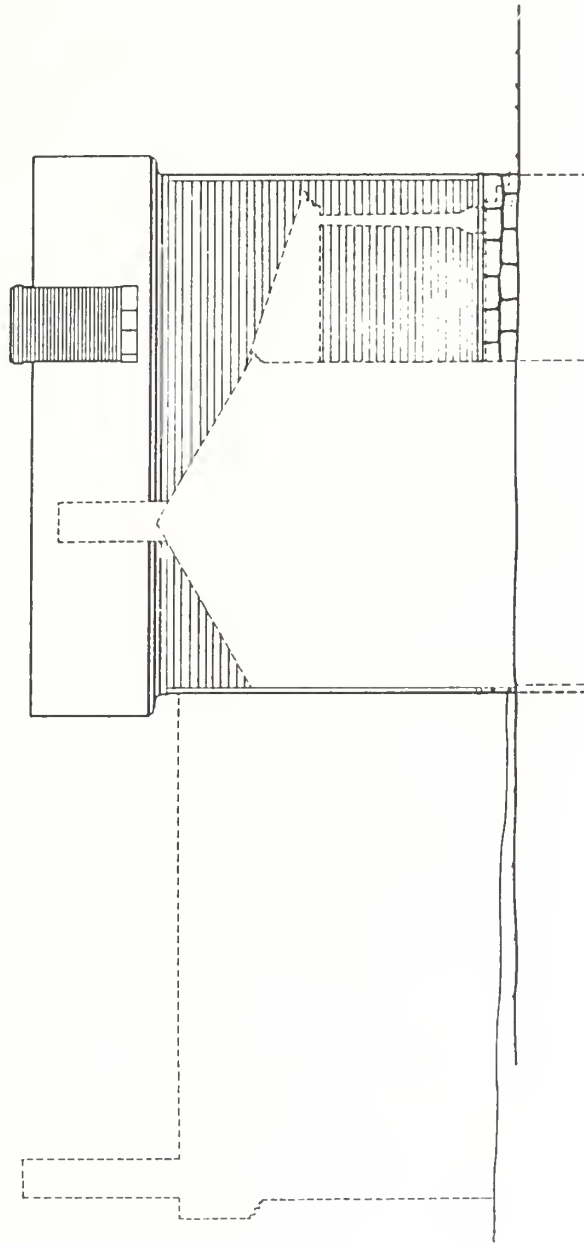

Figure 20. Stanton House: east elevation (conjectural view), circa 1847-62.



CONJECTURED
NORTH ELEVATION

DRAWN BY JANA L. GROSS, 1989

UNITED STATES DEPARTMENT OF INTERIOR
WOMEN'S RIGHTS NATIONAL HISTORICAL PARK
NATIONAL PARK SERVICE

FEET INCHES
0 1 2 3 4 5 6 7 8 9 10

ELIZABETH CADY STANTON HOUSE
SENECA FALLS SENECA COUNTY NEW YORK

CAULFIELD ARCHITECTS CENTER
300 OGDEN CONSERVATION CENTER
NORTH AVENUE
SENECA FALLS
NEW YORK 13152

DRAWING NO.
SHEET

Figure 21. Stanton House: north elevation (conjectural view), circa 1847-62.

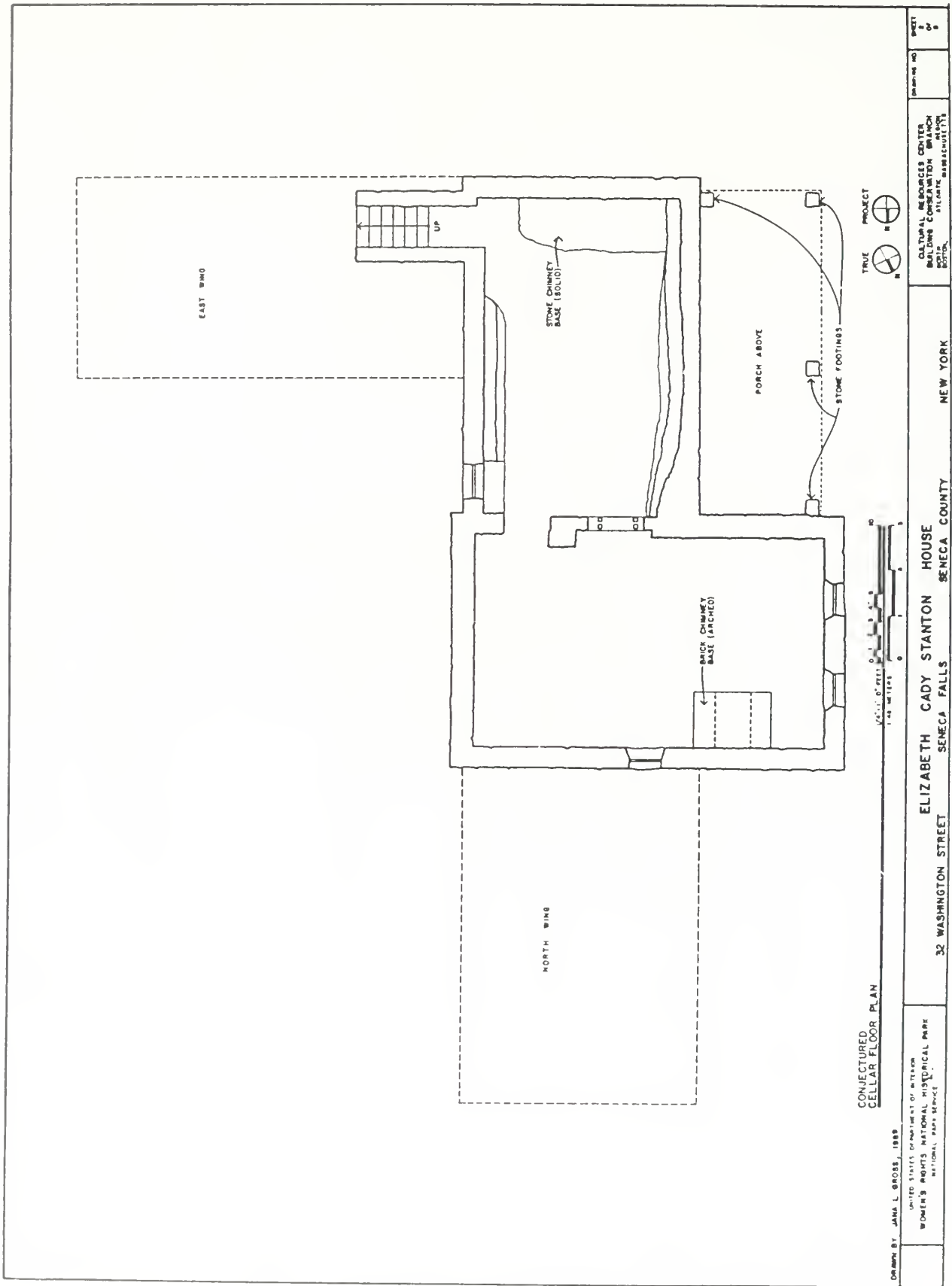

Figure 22. Stanton House: Conjectured cellar plan, circa 1847-62.

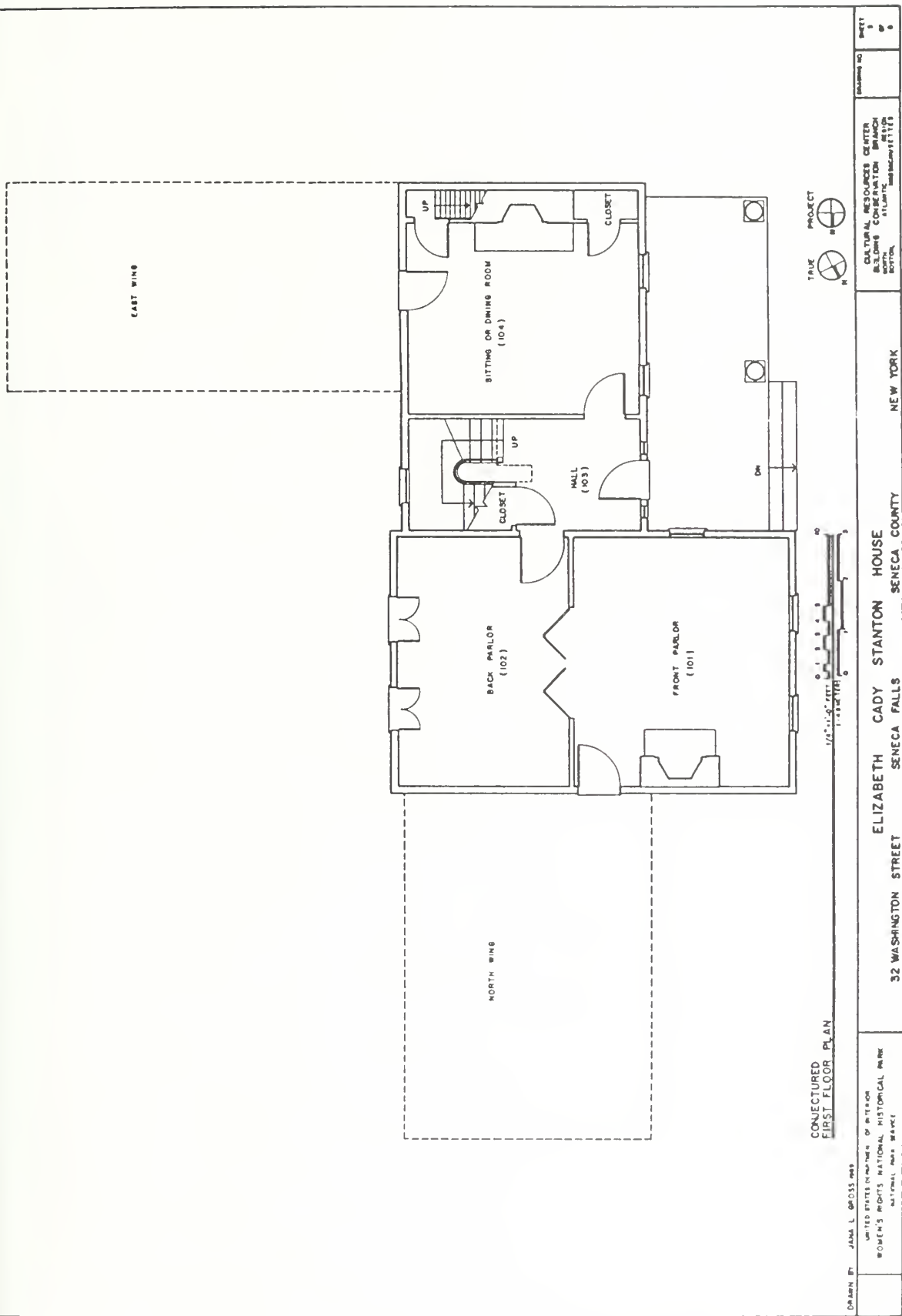

Figure 23. Stanton House: conjectured first-floor plan, circa 1847-62.

V. EXISTING CONDITIONS AND
RECOMMENDATIONS

by
d
m
p
o
f
P

h
r

EXISTING CONDITIONS

Background

The condition of the Stanton House as it existed in 1982 is recorded on the following pages by measured architectural drawings and annotated black and white photographs. The architectural drawings were made by the Historic American Buildings Survey in the summer of 1982. Room numbers have been added to the first- and second-floor plans for the purposes of this report. The photographs were taken by the author in the summer of 1982. In some cases, several photographs of the same feature (such as a wall) are included to illustrate the uncovering of historic features following the removal of modern materials. The negatives are on file at the North Atlantic Historic Preservation Center in Boston, Massachusetts.

In addition to the architectural drawings and the photographs, the existing conditions of the house were also recorded in site drawings. These drawings are included in Appendix H of this report.

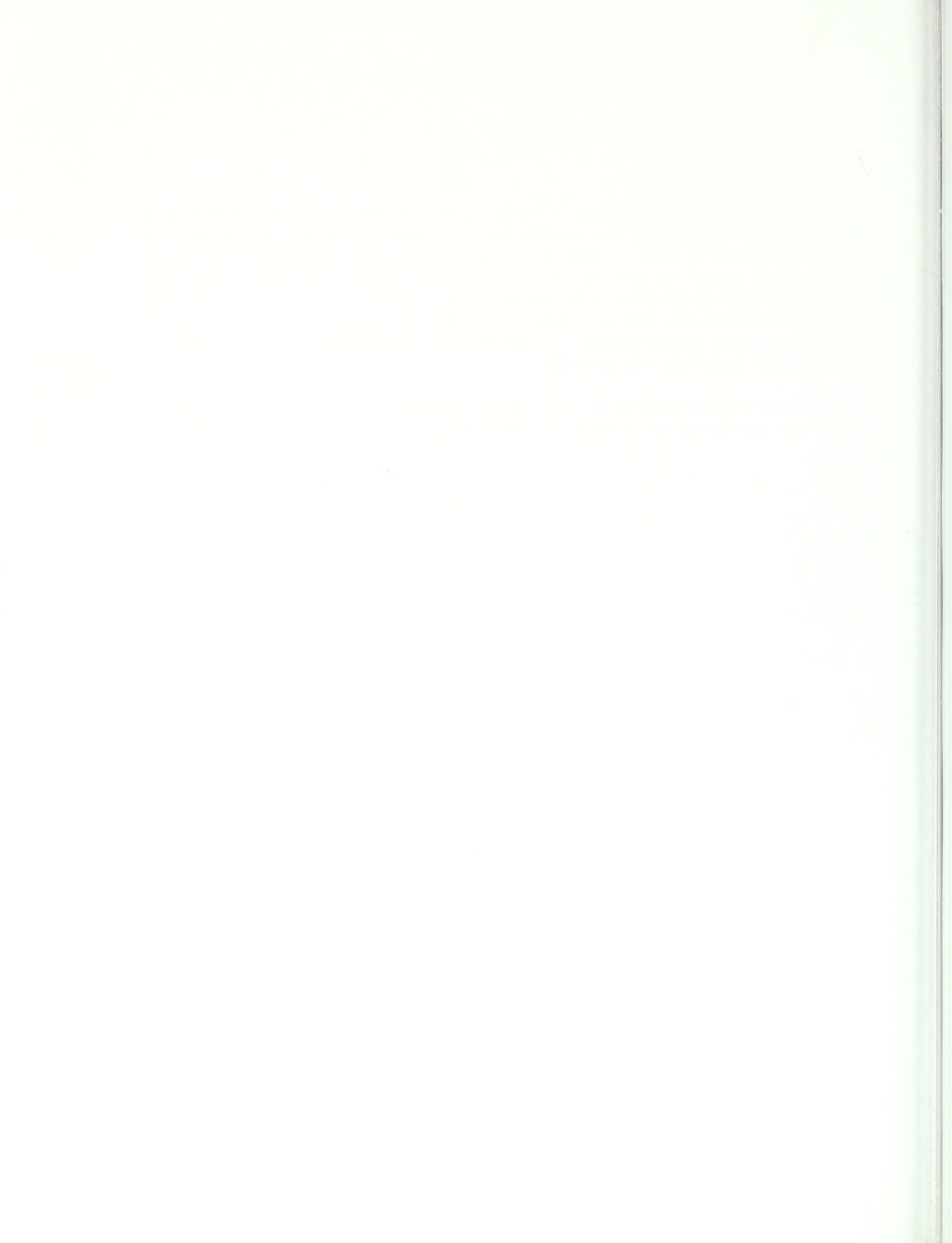

Exterior Conditions

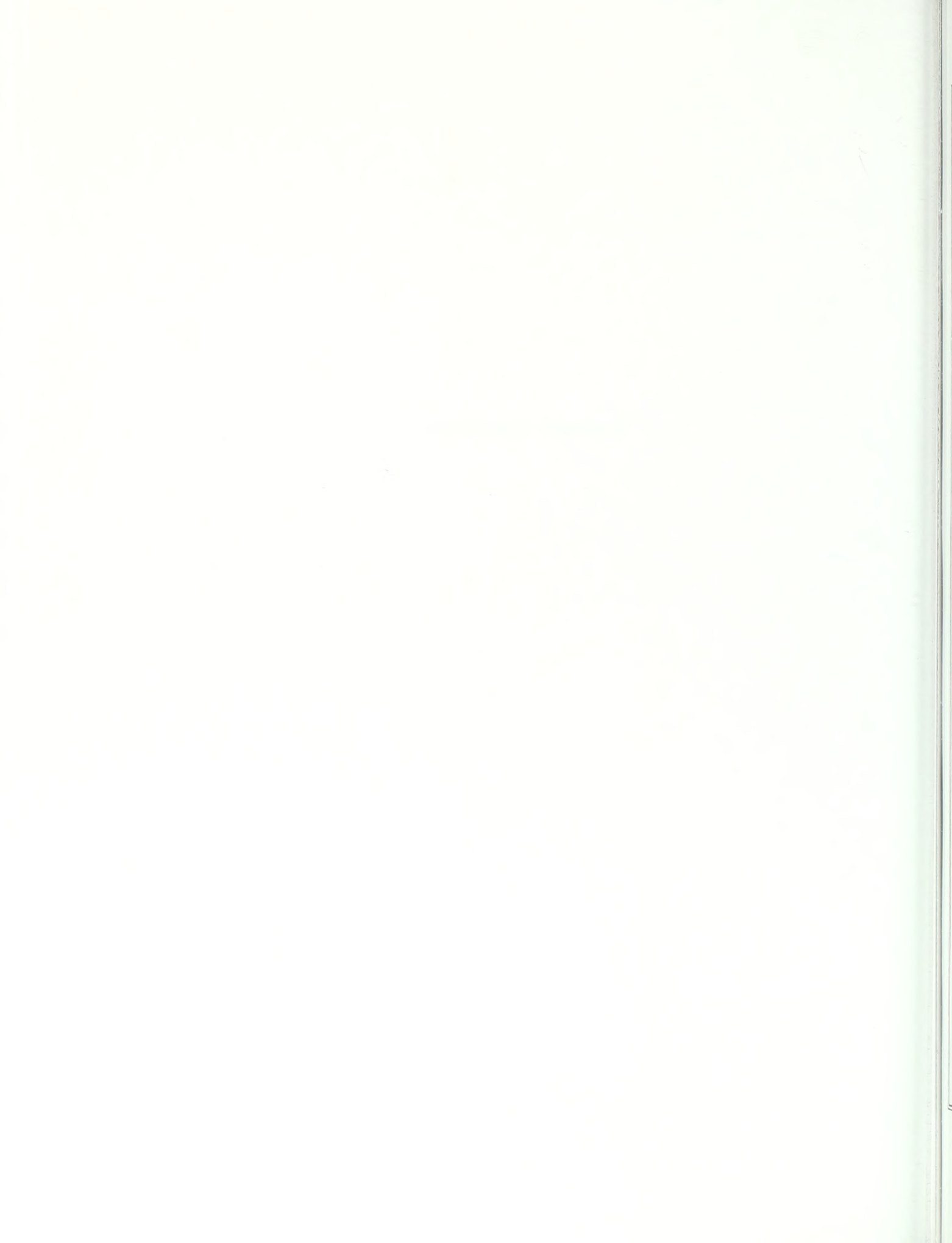

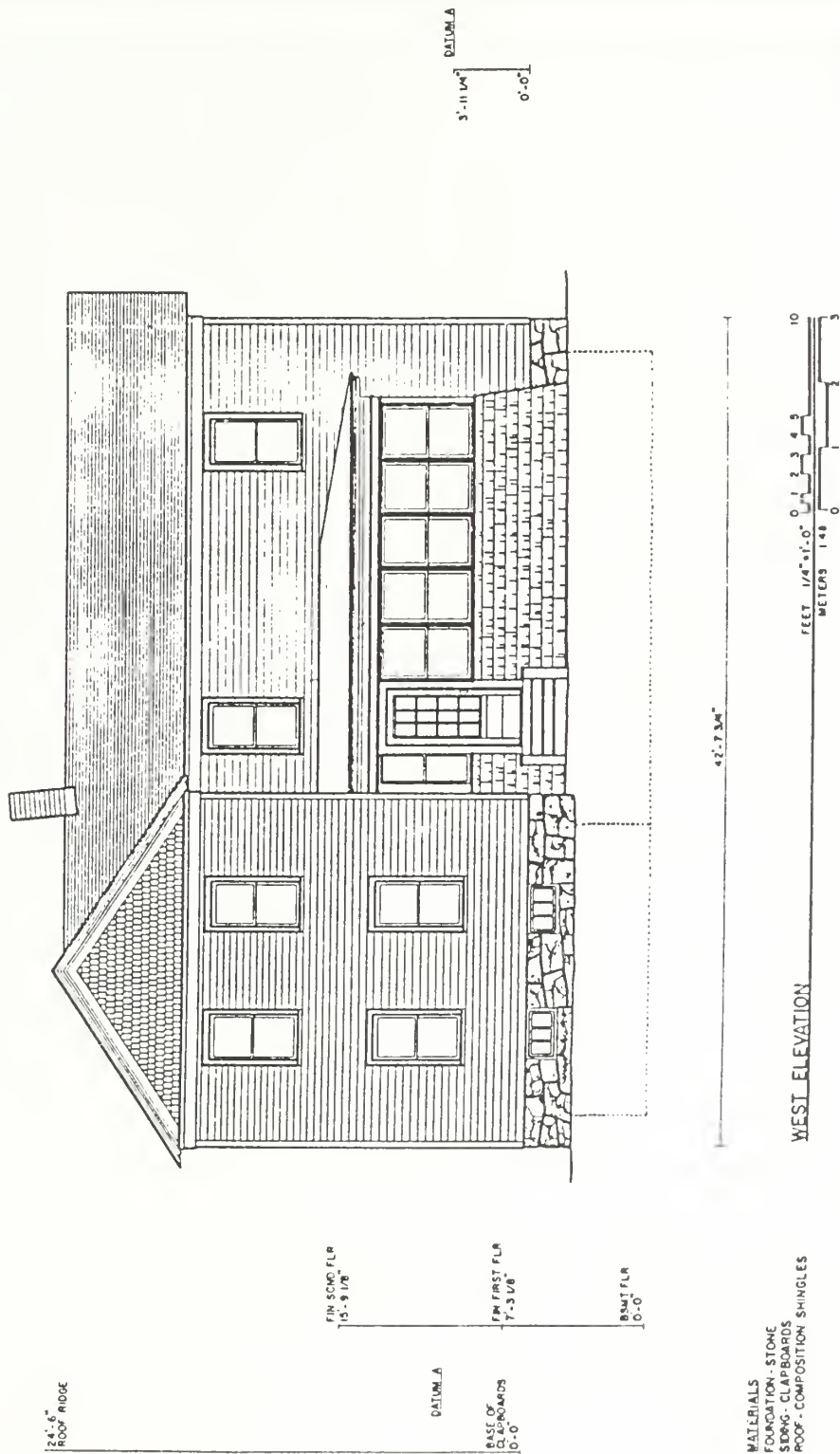

MATERIALS
 FOUNDATION - STONE
 SIDING - CLAPBOARDS
 ROOF - COMPOSITION SHINGLES

DRAWN BY PAUL D. DOLINSKY AND REBECCA TRUMBULL, INKED BY REBECCA TRUMBULL, 1982
 WOMEN'S RIGHTS NATIONAL HISTORICAL PARK
 NATIONAL HISTORICAL LAND MARKS SECTION
 UNITED STATES DEPARTMENT OF THE INTERIOR

NAME AND LOCATION OF STRUCTURE
ELIZABETH GADY STANTON HOUSE
 SENECA COUNTY
 SENECA FALLS

SURVEY NO.
 NY
 6103

HISTORIC AMERICAN
 BUILDINGS SURVEY
 sheet 6 of 7 sheets

Figure 25. Stanton House: west elevation, summer 1982.

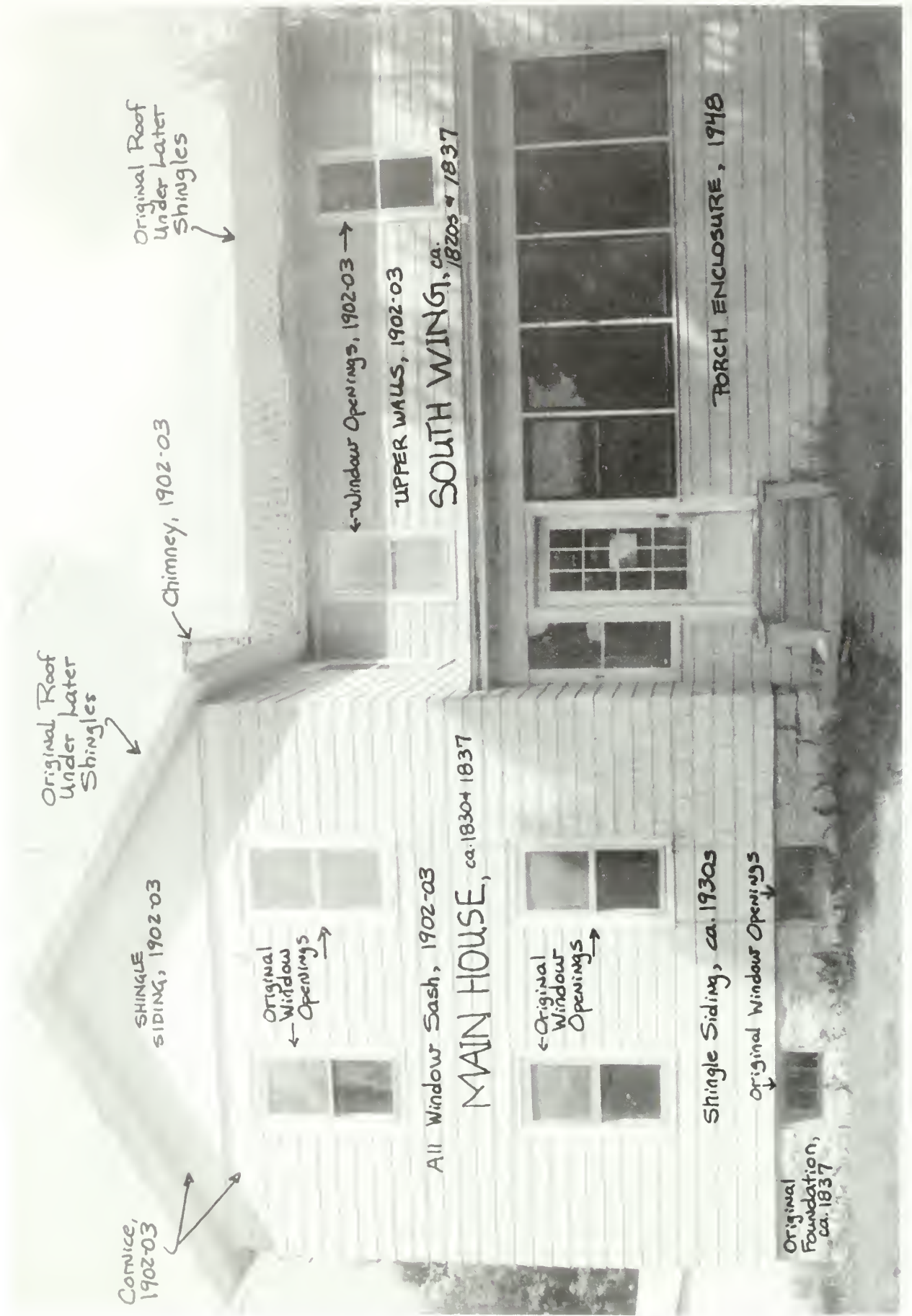

Comice,
1902-03

SHINGLE
SIDING, 1902-03

Original Roof
Under later
Shingles

Original Roof
Under later
Shingles

Chimney, 1902-03

Original
Window
Openings

Window Openings, 1902-03

UPPER WALLS, 1902-03

All Window Sash, 1902-03

SOUTH WING, ca.
1820s-1837

MAIN HOUSE, ca. 1830-1837

Original
Window
Openings

Shingle Siding, ca. 1930s

Original Window Openings

Original
Foundation,
ca. 1837

PORCH ENCLOSURE, 1948

Figure 26. Stanton House: west elevation, June 1982.

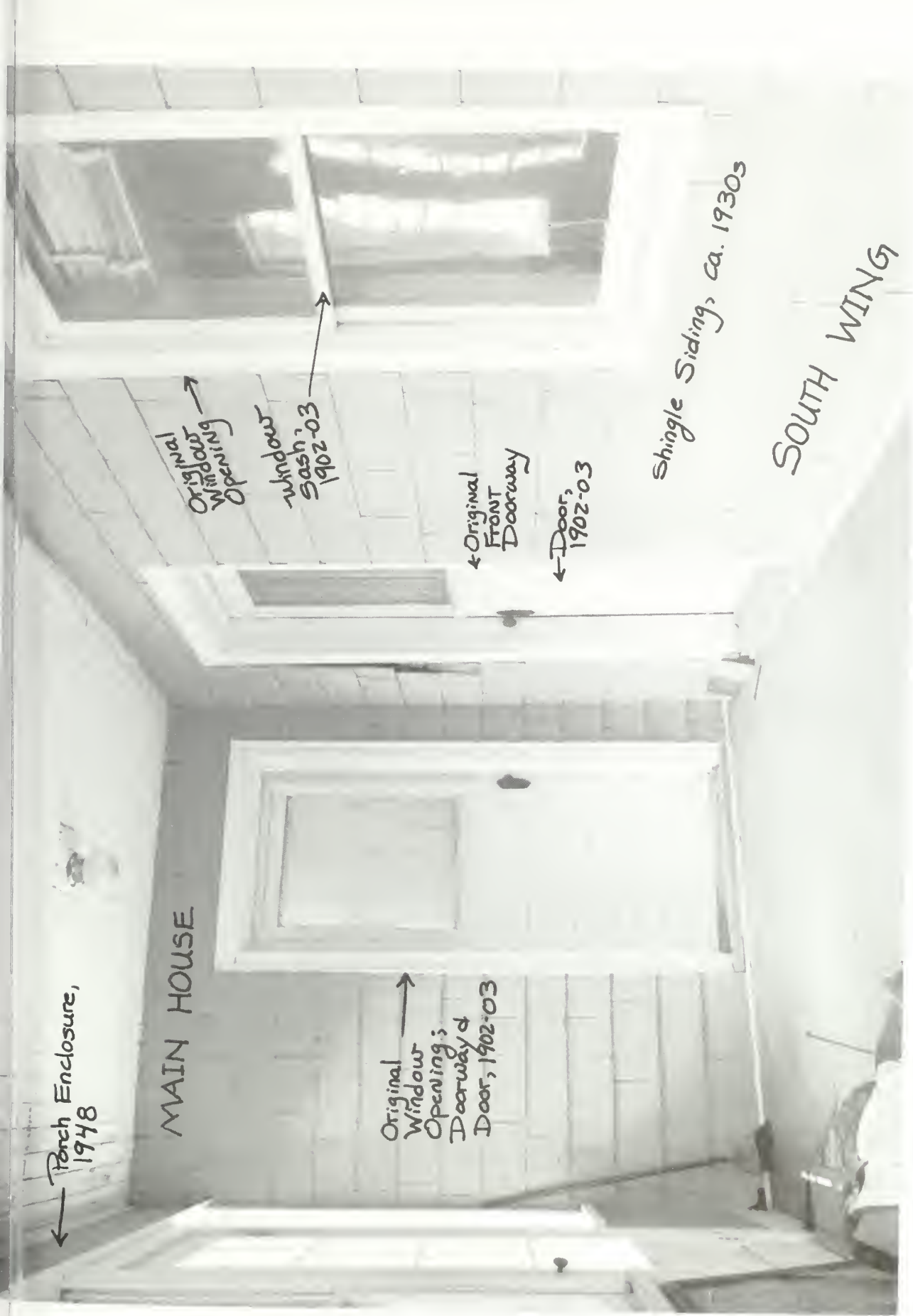

Figure 27. Stanton House: front porch interior, June 1982.

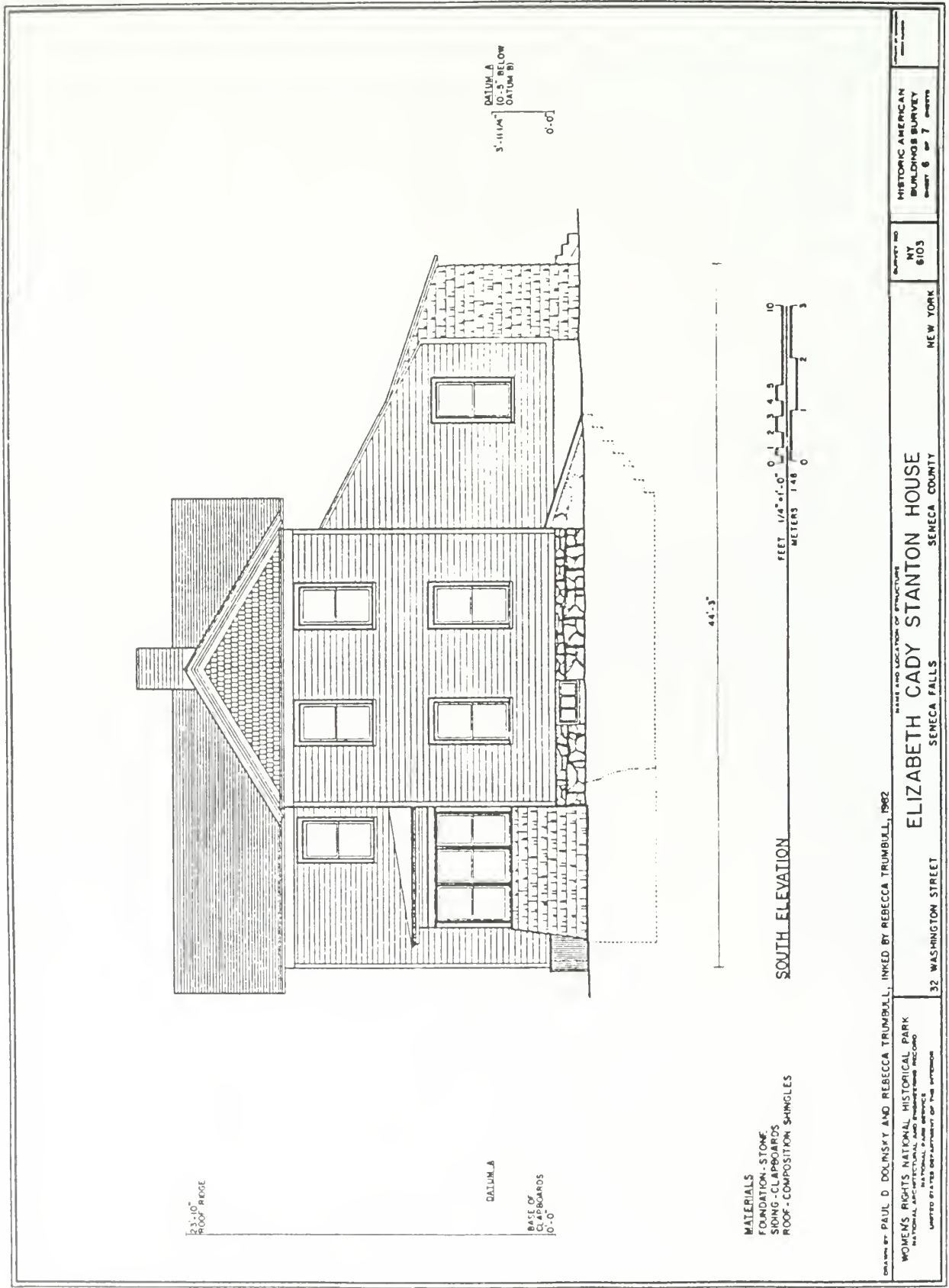
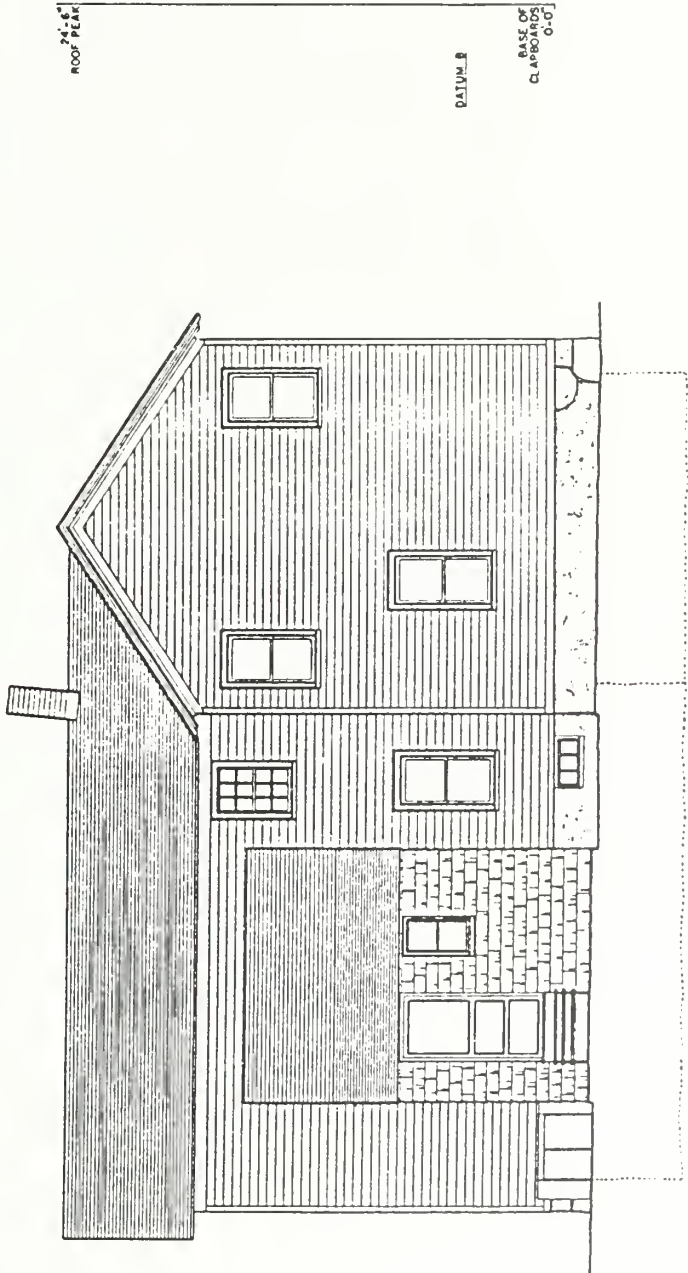

Figure 28. Stanton House: south elevation, summer 1982.



DATUM B 14'-4"
10'-0"

ROOF PEAR 24'-6"
DATUM B
BASE OF CLAPBOARDS 0'-0"

42'-7.3"

MATERIALS
FOUNDATION - STONE
SIDING - CLAPBOARDS
ROOF - COMPOSITION SHINGLES

EAST ELEVATION

FEET 1/4"=1'-0" 0 1 2 3 4 5 10
METERS 1:48 0 1 2 3

DESIGNED BY PAUL D. DOLINSKY, INKED BY REBECCA TRUMBULL, 1982

WOMEN'S RIGHTS NATIONAL HISTORICAL PARK
NATIONAL JOURNAL OF ARCHITECTURE AND HISTORIC PRESERVATION
NATIONAL ARCHIVES AND RECORDS ADMINISTRATION
UNITED STATES DEPARTMENT OF THE INTERIOR

NAME AND LOCATION OF STRUCTURE

ELIZABETH CADY STANTON HOUSE
SENECA FALLS
SENECA COUNTY

32 WASHINGTON STREET

NEW YORK

SURVEY NO.
NY
6103

HISTORIC AMERICAN
BUILDINGS SURVEY
Sheet 7 of 7 sheets

Figure 29. Stanton House: east elevation, summer 1982.

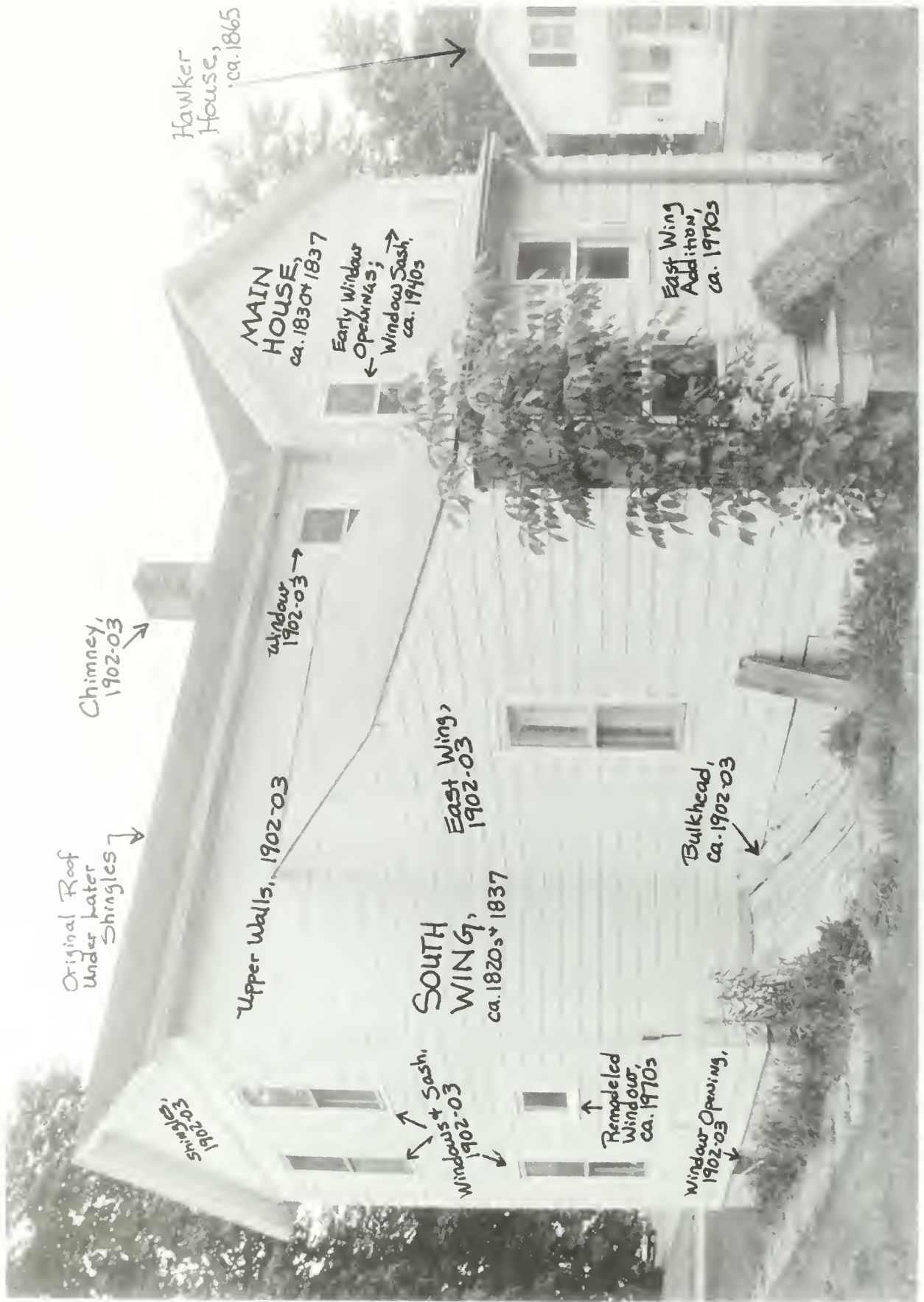

Figure 30. Stanton House: southeast elevation, June 1982.

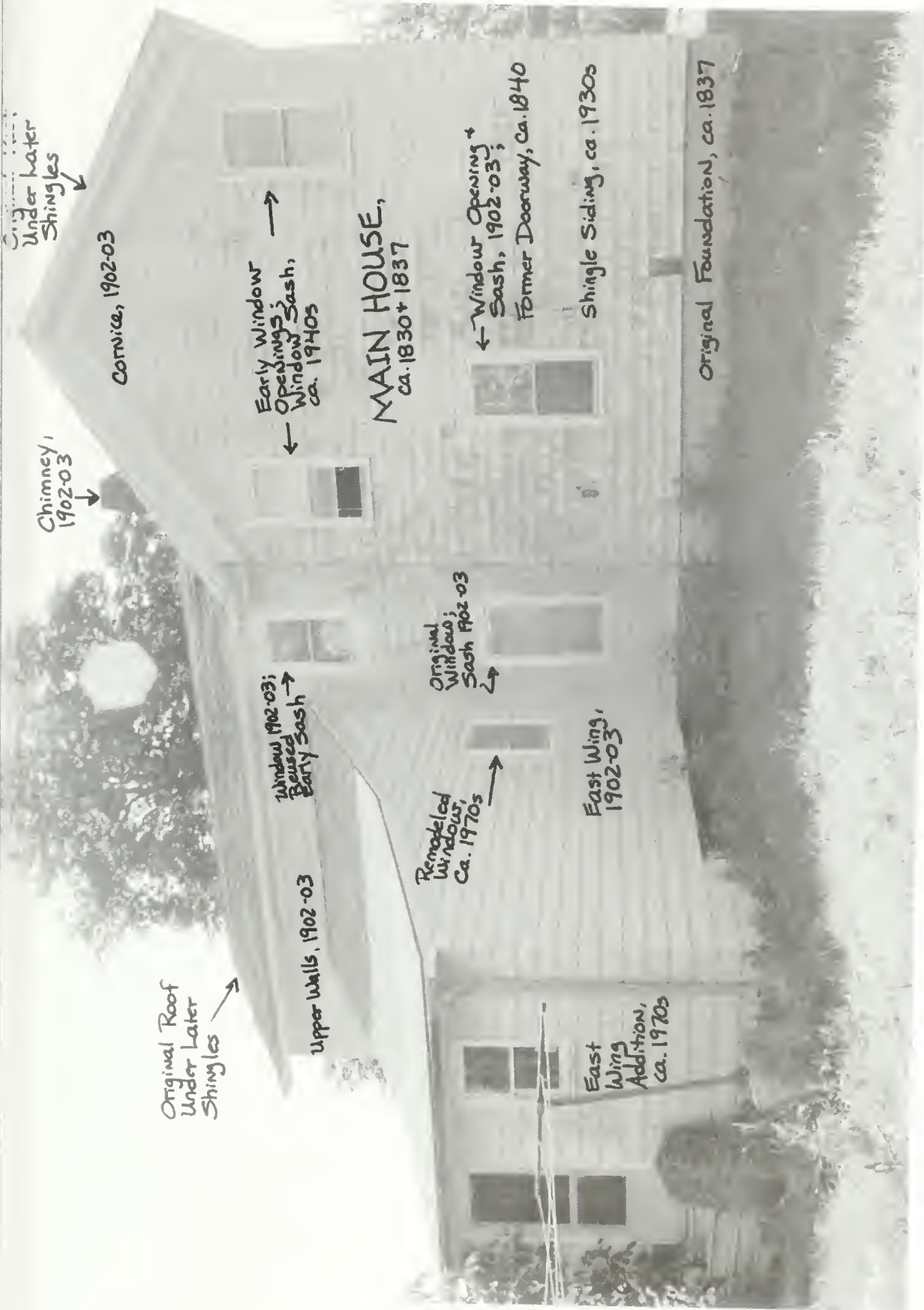

Figure 31. Stanton House: east elevation, June 1982.

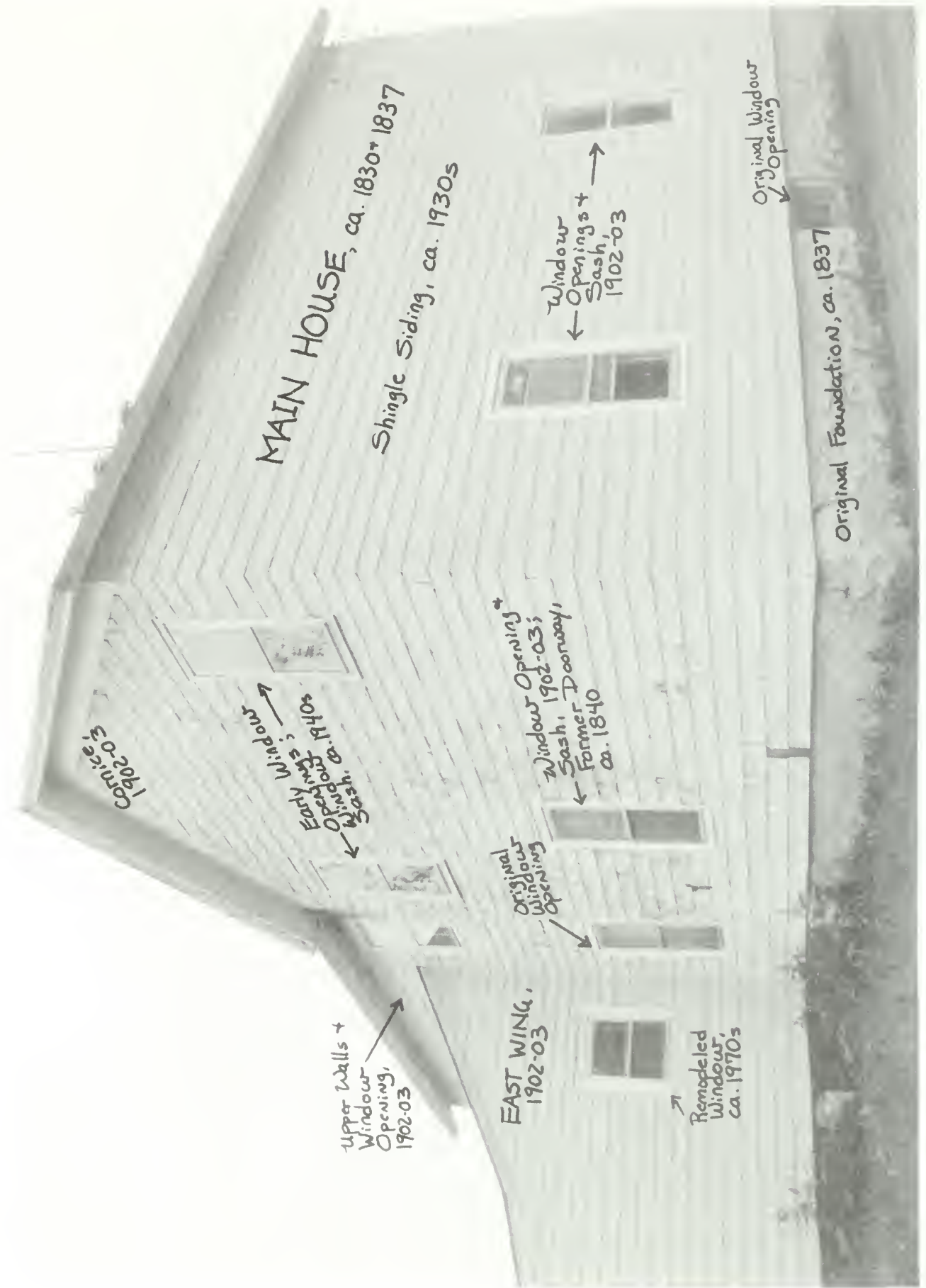

Figure 32. Stanton House: north and east elevations, June 1982.

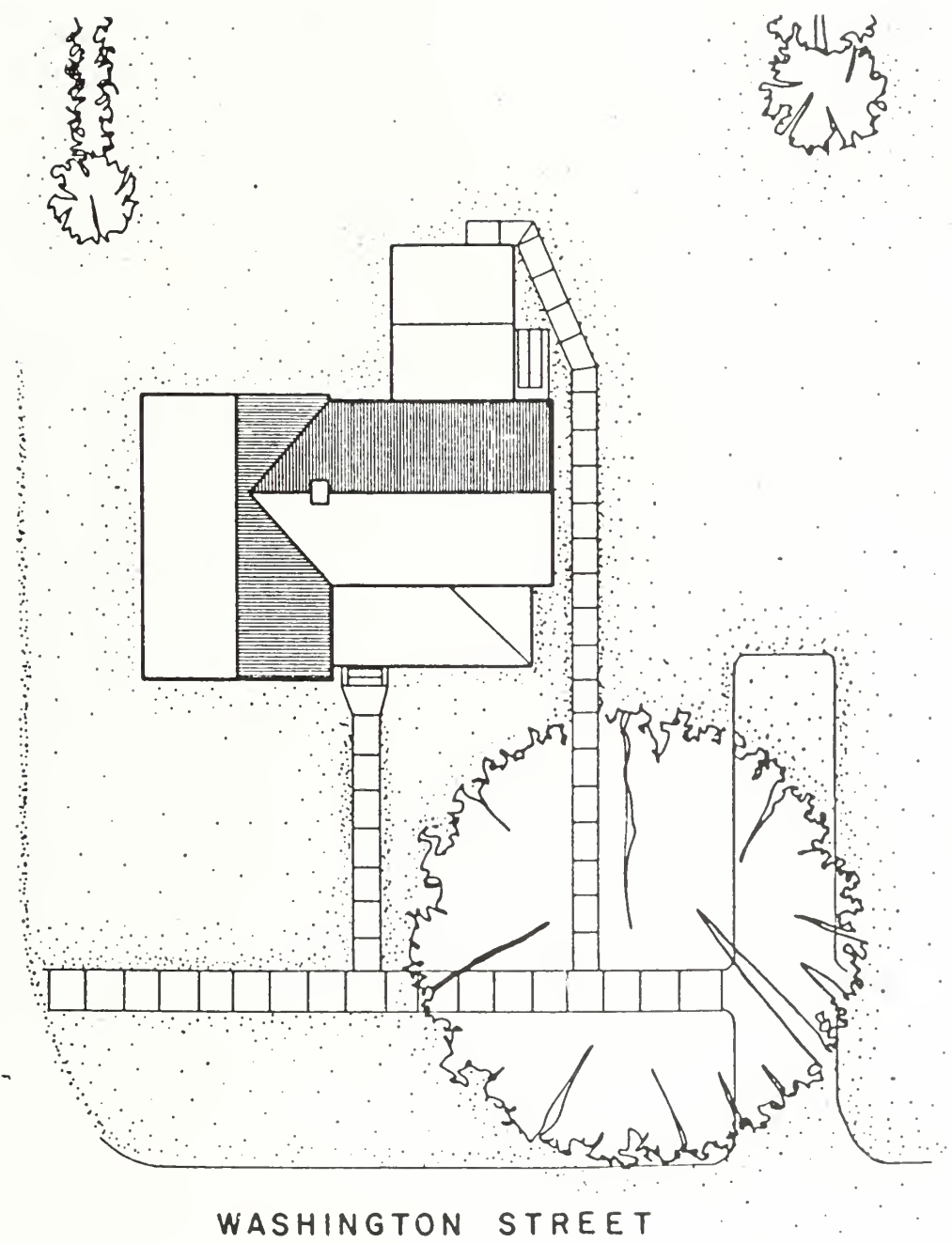
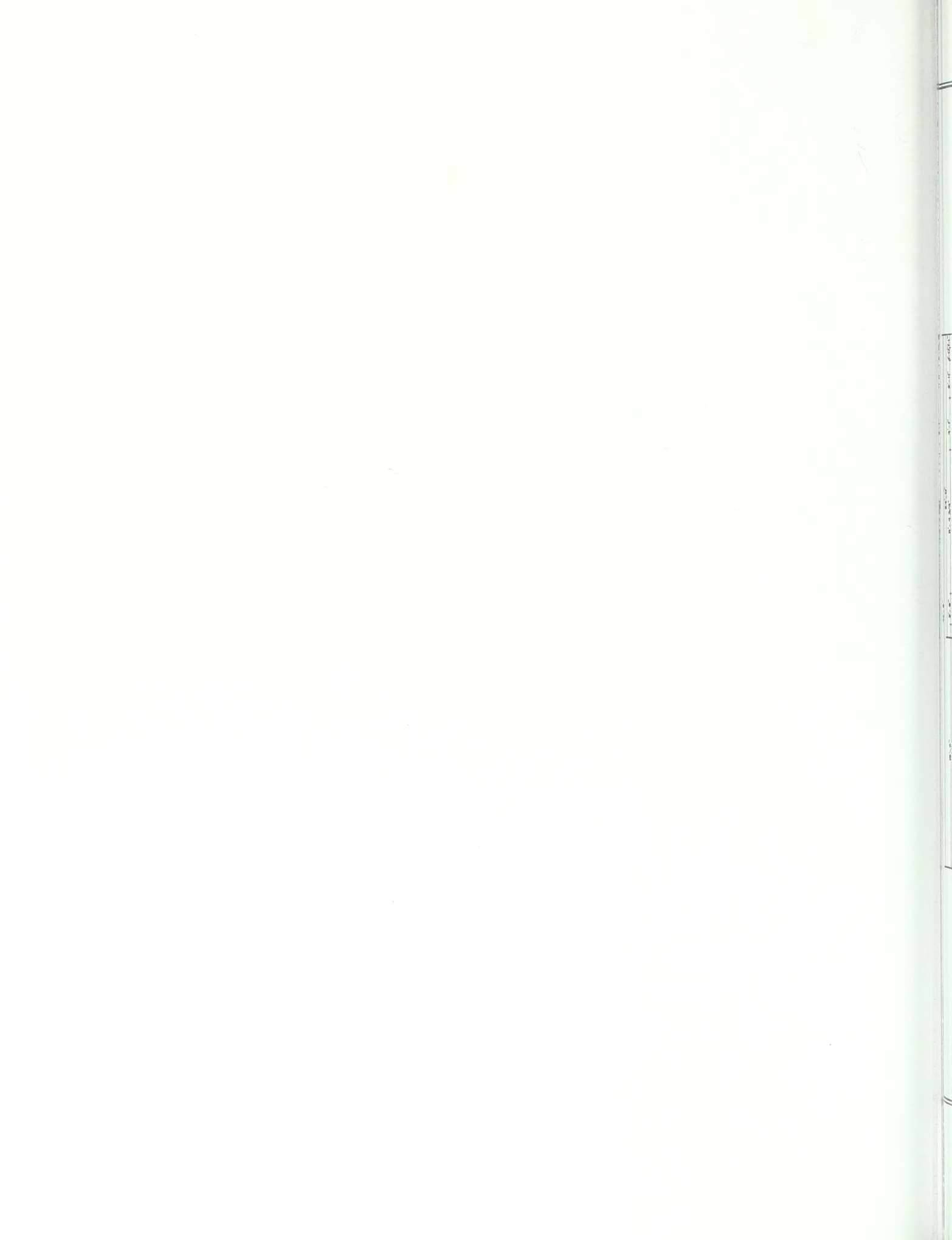
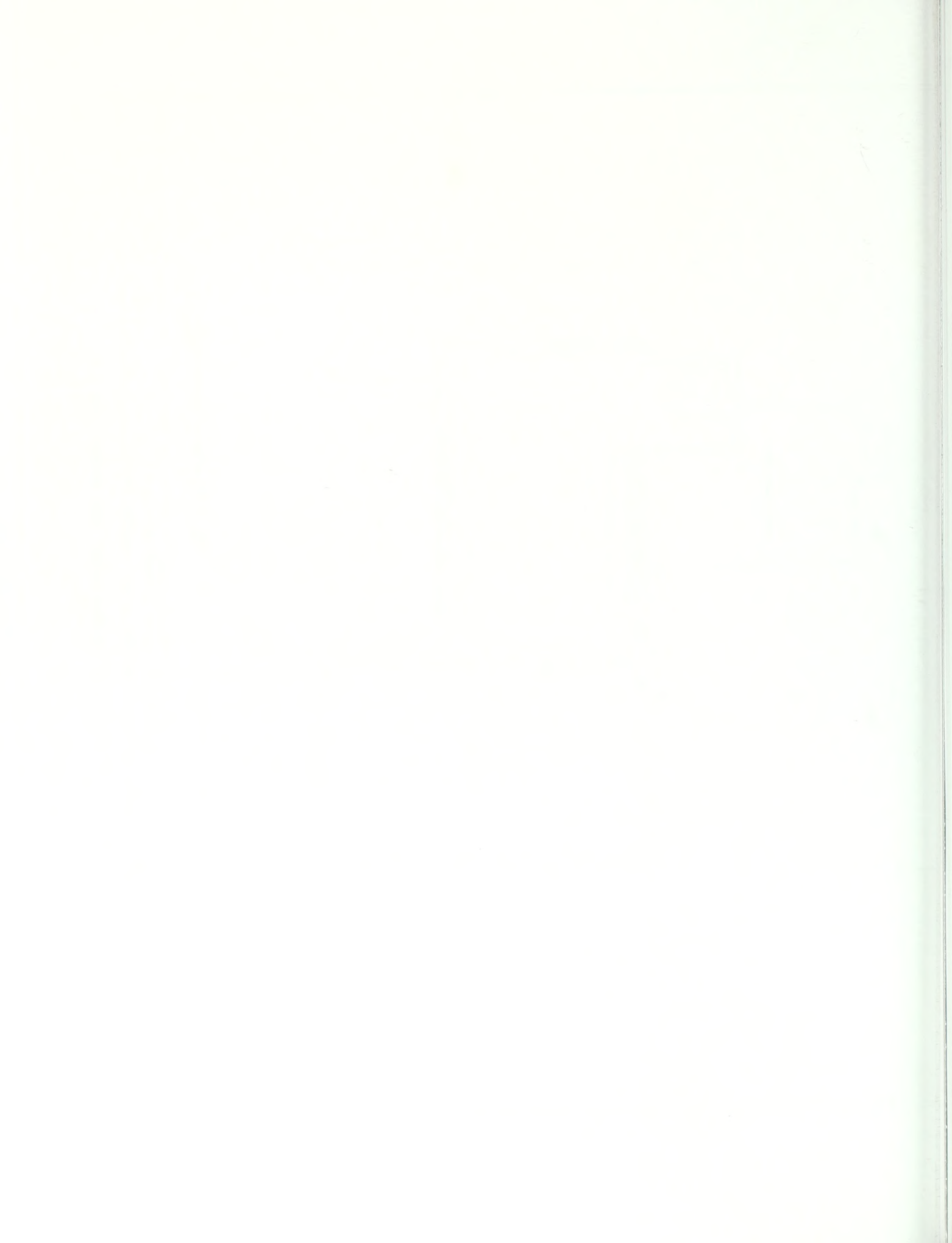

Figure 33. Stanton House: roof and site plan, summer 1982.



Interior Conditions: Cellar





Interior Conditions: First Story



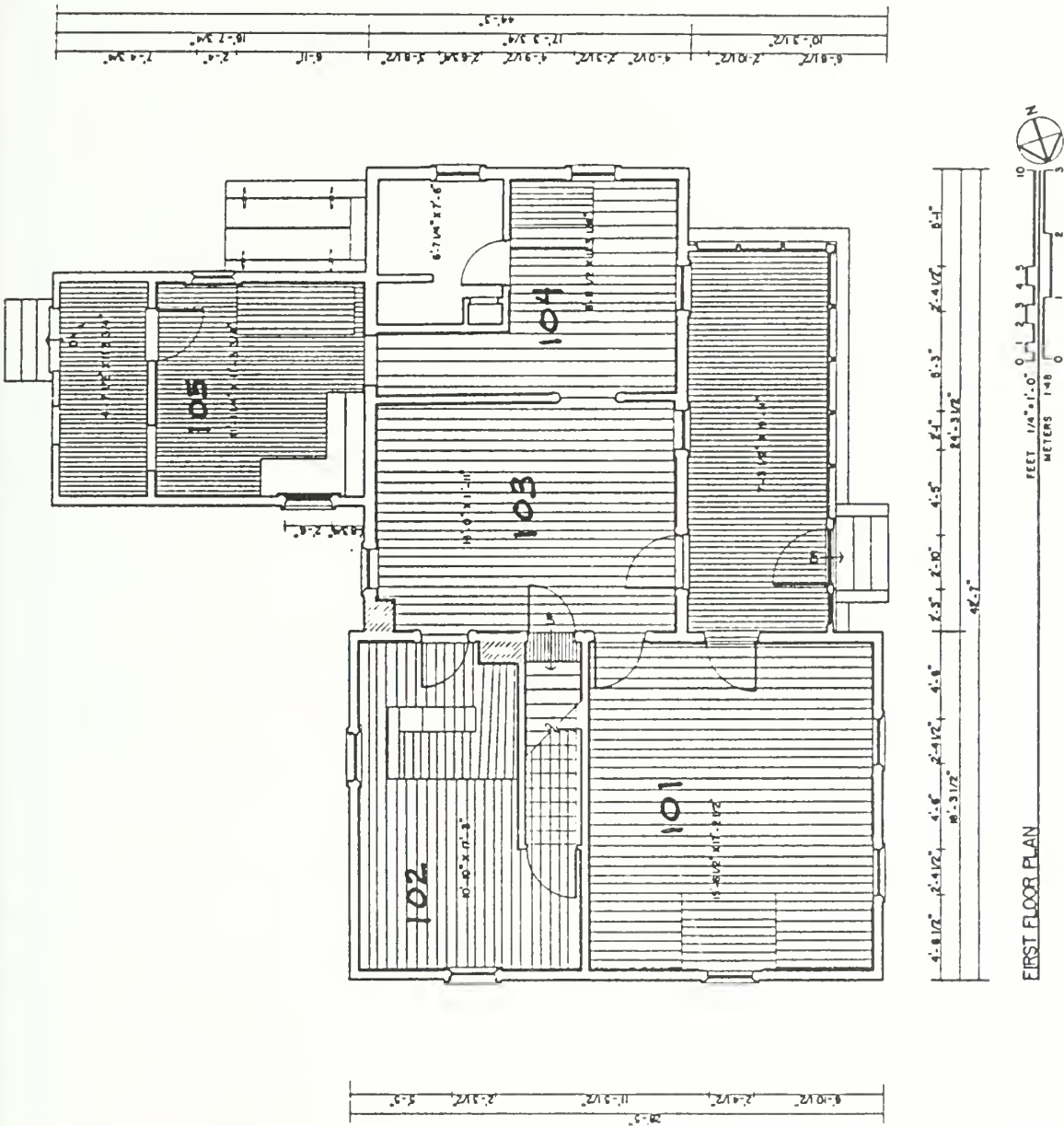

FIRST FLOOR PLAN

DRAWN BY: PAUL D. COLINSKY, 1982 WOMEN'S RIGHTS NATIONAL HISTORICAL PARK NATIONAL ARCHITECTURAL AND ENGINEERING RECORD NATIONAL PARK SERVICE UNITED STATES DEPARTMENT OF THE INTERIOR	NAME AND LOCATION OF STRUCTURE ELIZABETH CADY STANTON HOUSE SENECA FALLS SENECA COUNTY NEW YORK	SURVEY NO. NY 6103 HISTORIC AMERICAN BUILDINGS SURVEY Sheet 3 of 7 sheets
---	--	--

Figure 35. Stanton House: first-floor plan, summer 1982.

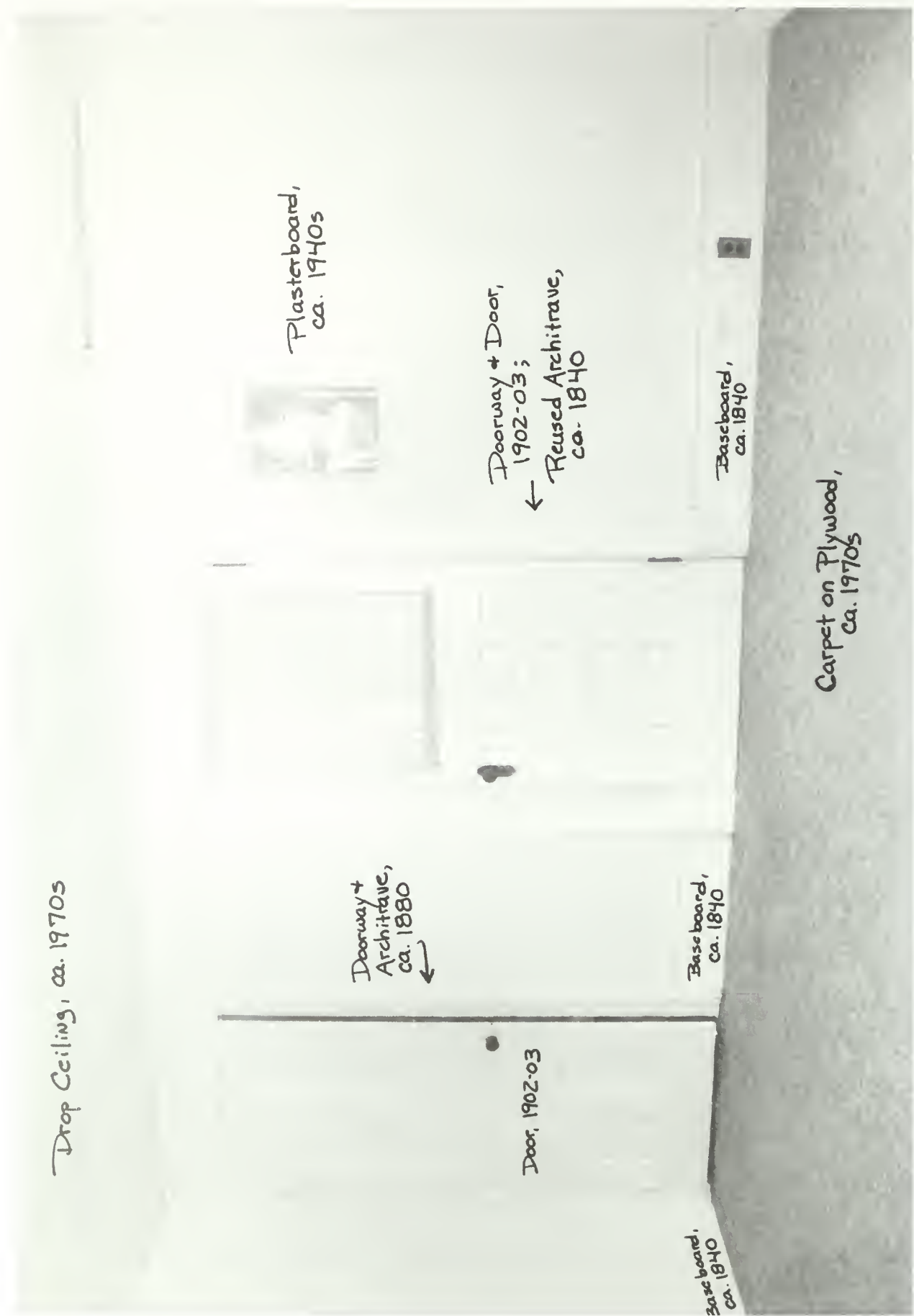

Drop Ceiling, ca. 1970s

Doorway +
Architrave,
ca. 1880
↘

Door, 1902-03

Plasterboard,
ca. 1940s

Doorway + Door,
1902-03;
↙ Reused Architrave,
ca. 1840

Baseboard,
ca. 1840

Baseboard,
ca. 1840

Carpet on Plywood,
ca. 1970s

Baseboard,
ca. 1840

Figure 36. Stanton House: Room 101, looking south, June 1982.

Drop Ceiling, ca. 1970s

← Window Openings, →
ca. 1830;

Architraves, ca. 1840;

Window Sash, 1902-03

Plasterboard,
ca. 1940s

Baseboard Heating Units, ca. 1960s

Carpet on Plywood,
ca. 1970s

Figure 37. Stanton House: Room 101, looking west, June 1982.

Drop Ceiling, ca. 1970s

Plasterboard, ca. 1940s

← Window Opening
+ Sash, 1902-03;
Architrave, ca. 1840

Baseboard, ca. 1840 ↓

Baseboard Heating Units, ca. 1960s

Carpet on Plywood,
ca. 1970s

Reused ca. 1840 Baseboard
Baseboard, ca. 1840

Figure 38. Stanton House: Room 101, looking north, June 1982.

Drop Ceiling,
ca. 1970s

"Ralph Peters"
Commemorative
Plaque

Plasterboard,
ca. 1940s

Mantel, ca. 1840;
Relocated From
North Wall,
1902-03 →

Plasterboard, ca. 1940s

Baseboard, ca. 1840
Reused ca. 1840
Baseboard

Baseboard,
1902-03

Reused ca. 1840
Baseboard →

Carpet on Plywood,
ca. 1970s

Baseboard, ca. 1840

Figure 39. Stanton House: Room 101, looking east, June 1982.

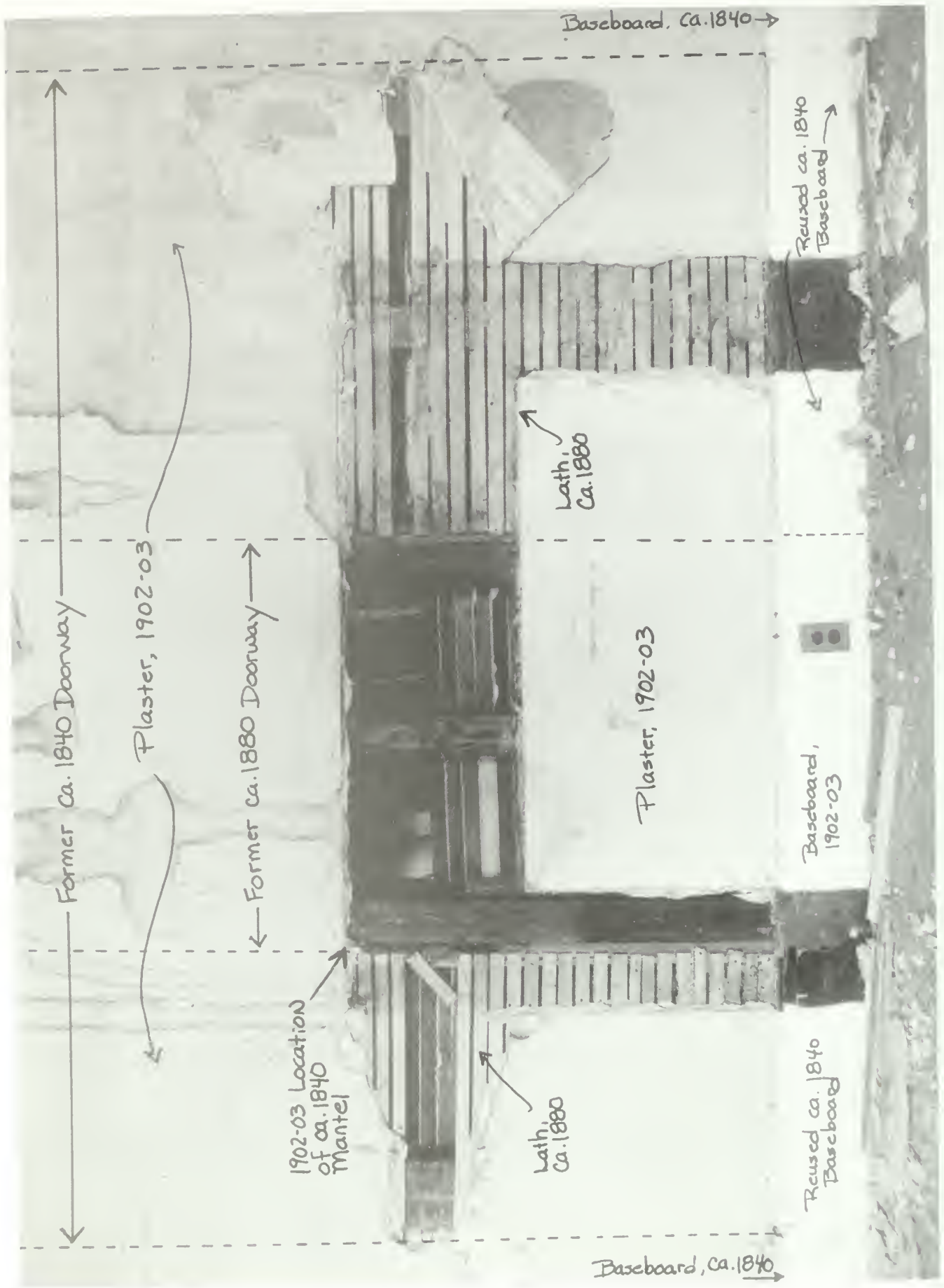

Figure 40. Stanton House: Room 101, detail of east wall, July 1982.



Figure 41. Stanton House: Room 101, looking southeast, July 1982.

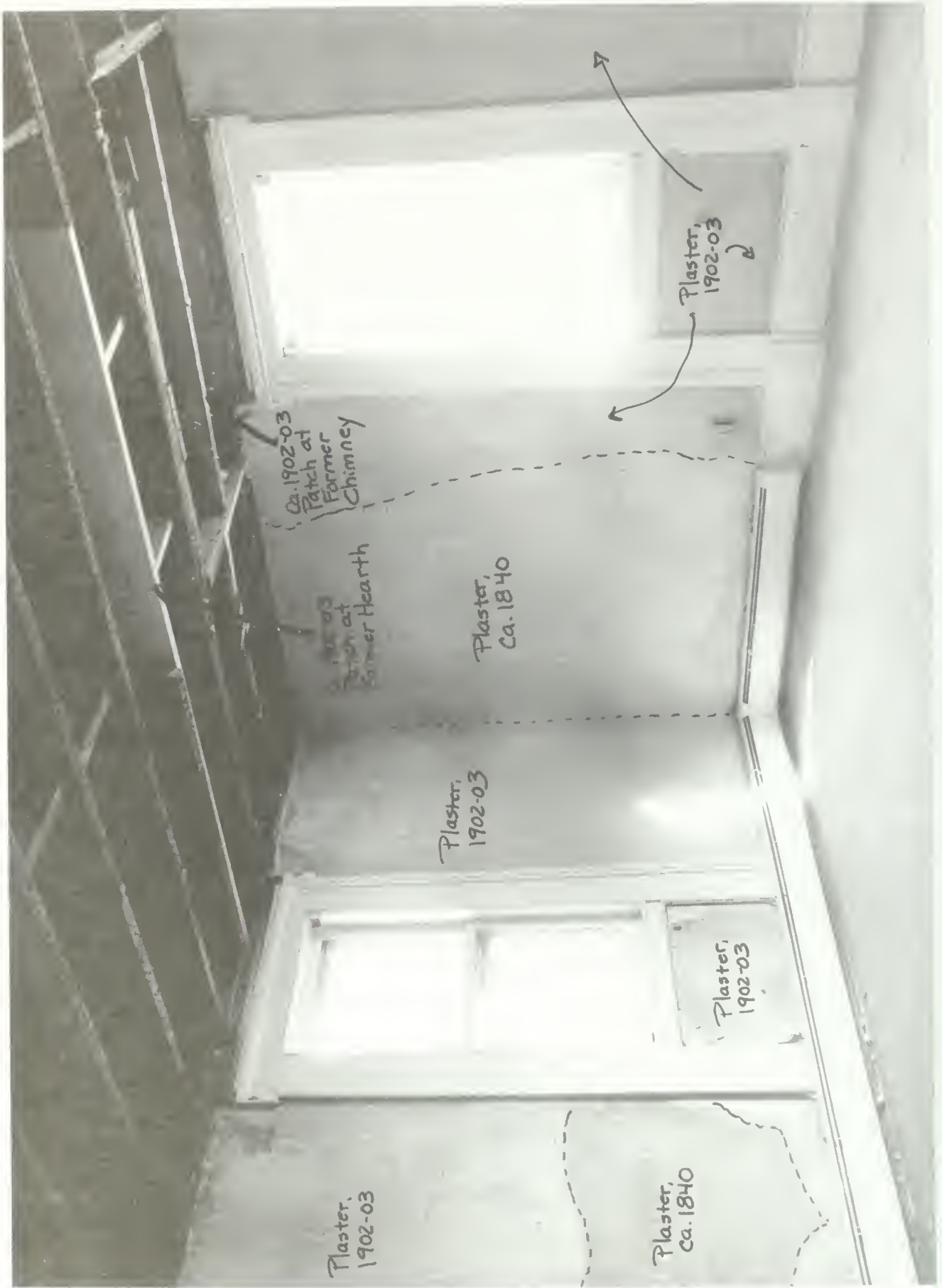

Figure 42. Stanton House: Room 101, looking northwest, July 1982.

Paneling, ca. 1970s

Window, 1902-03

Baseboard, 1902-03

Oak Floorboards,
ca. 1960s

Baseboard
Heating Unit, ca. 1960s

Figure 43. Stanton House: Room 102, looking east, June 1982.

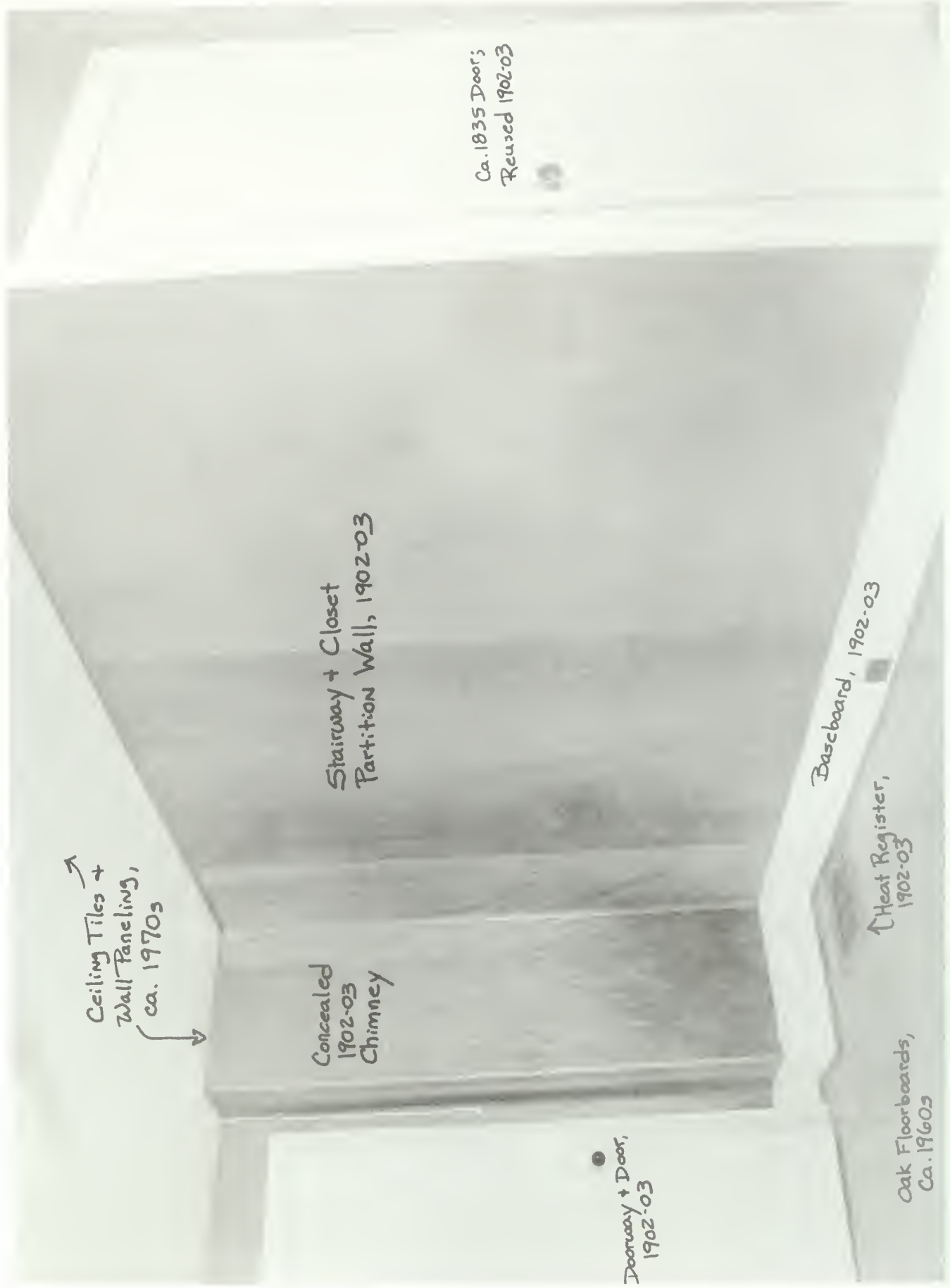

Ceiling Tiles +
Wall Paneling,
ca. 1970s

Concealed
1902-03
Chimney

Stairway + Closet
Partition Wall, 1902-03

●
Doorway + Door,
1902-03

↑ Heat Register,
1902-03

Baseboard, 1902-03

Oak Floorboards,
Ca. 1960s

Ca. 1835 Door;
Reused 1902-03

Figure 44. Stanton House: Room 102, looking southwest, June 1982.

Plasterboard Ceiling, ca. 1770's

Window Opening, ca. 1837;
All Woodwork, 1902-03

Doorway Opening, ca. 1837; modified 1902-03;
Door Architrave, 1902-03

Doorway Opening, ca. 1880;
All Woodwork, 1902-03

All Baseboards, 1902-03

Plasterboard Walls, ca. 1940s

Partition Wall Location, ca. 1837-1902

Baseboard Heating Unit, ca. 1960s

Oak Floorboards, ca. 1960s

Later Partition Wall, 1902-03

Figure 45. Stanton House: Room 103, looking west, June 1982.

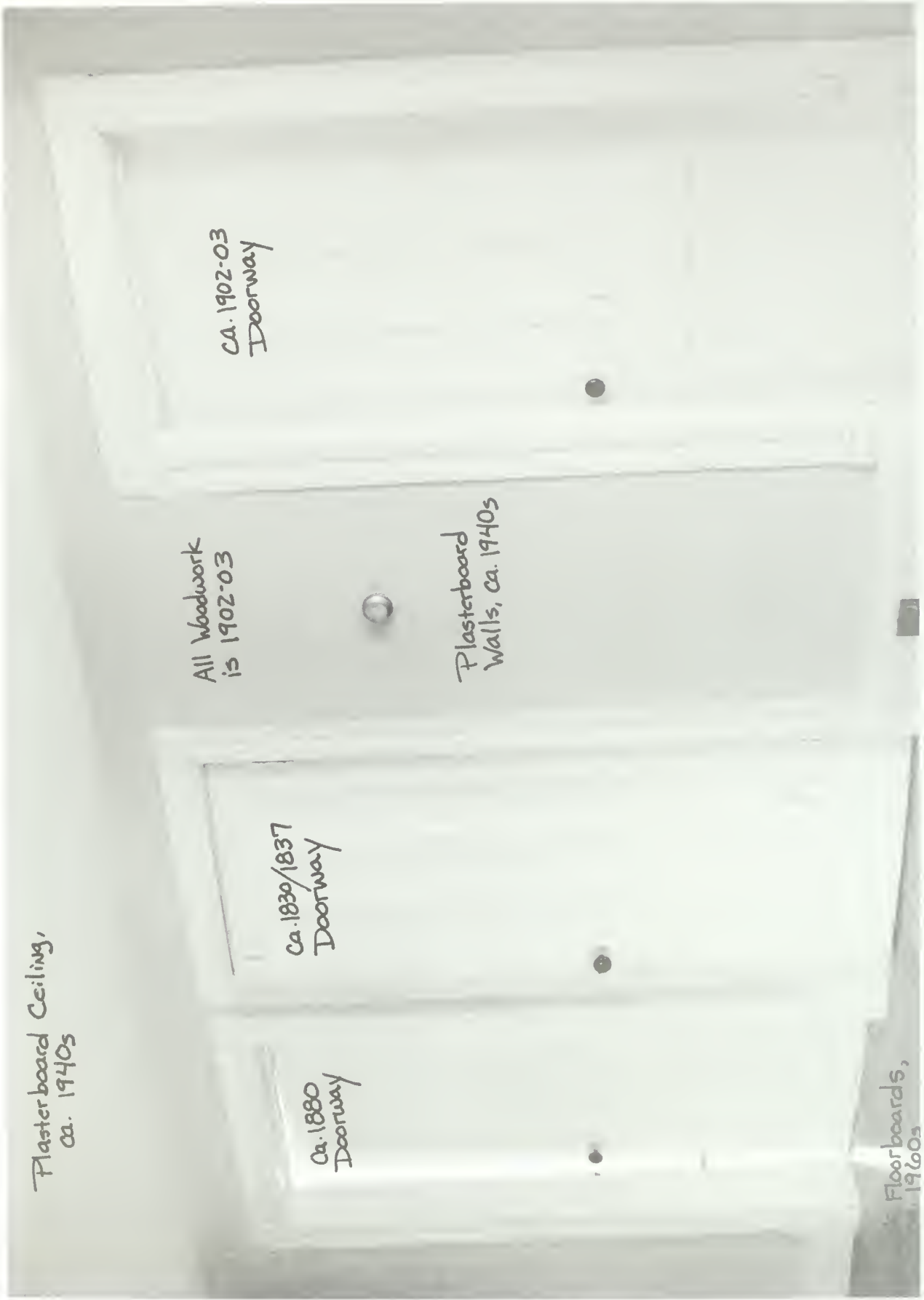

Plaster board Ceiling,
ca. 1940s

All Woodwork
is 1902-03

Plasterboard
Walls, ca. 1940s

Ca. 1830/1837
Doorway

Ca. 1880
Doorway

Ca. 1902-03
Doorway

Floorboards,
ca. 1960s

Figure 46. Stanton House: Room 103, looking north, June 1982.

Plasterboard Ceiling

Later Partition Wall,
1902-03

Plasterboard, Ca. 1940s

Doorway, 1902-03

Window
Opening,
Ca. 1837

Baseboard, 1902-03

Oak Floorboards,
ca. 1960s

Figure 47. Stanton House: Room 103, looking southwest, June 1982.

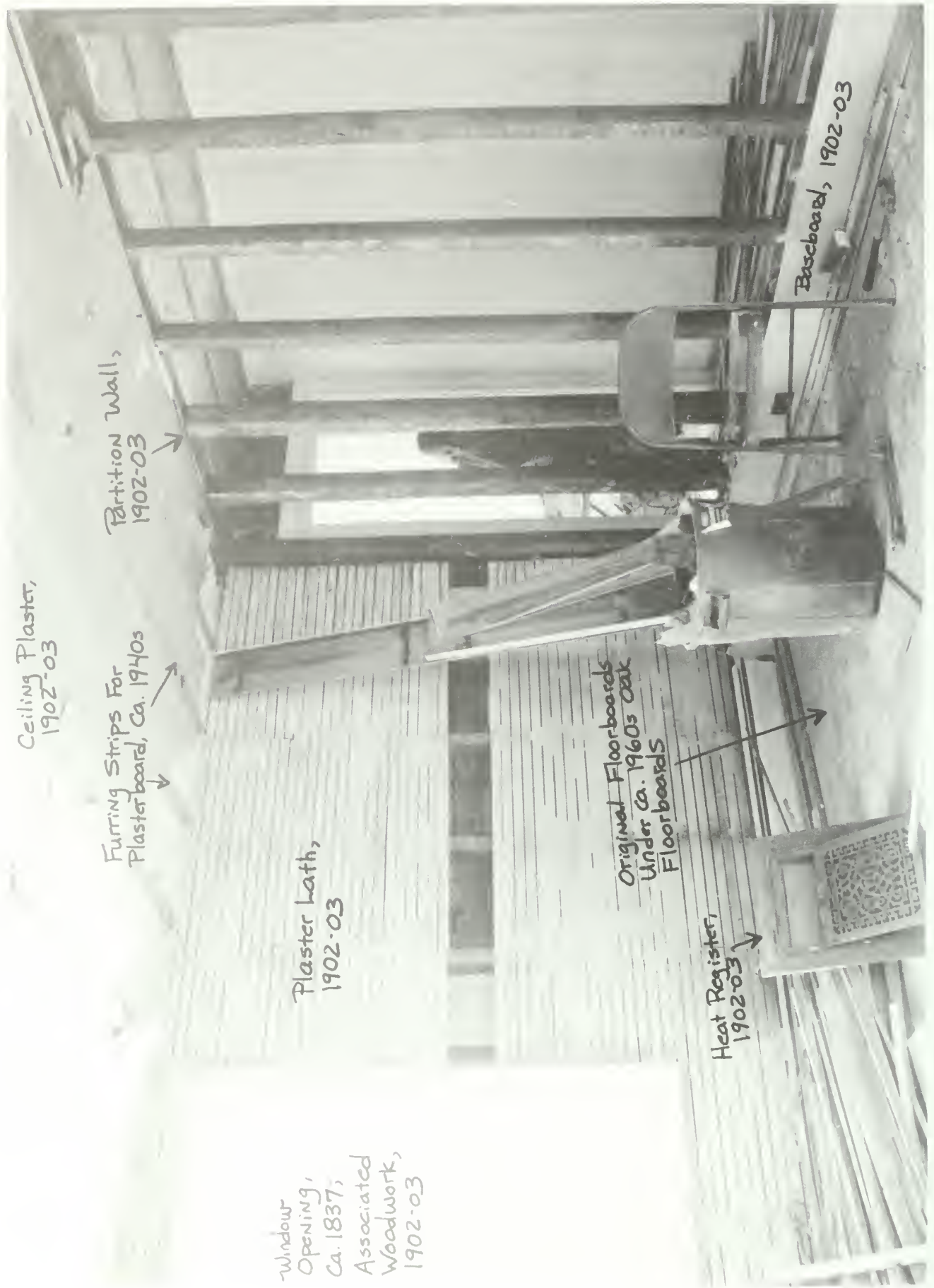

Window
Opening,
Ca. 1837,
Associated
Woodwork,
1902-03

Plaster Lath,
1902-03

Ceiling Plaster,
1902-03

Furring Strips For
Plasterboard, Ca. 1940s

Partition Wall,
1902-03

Original Floorboards
Under Ca. 1960s Oak
Floorboards

Heat Register,
1902-03

Baseboard, 1902-03

Figure 48. Stanton House: Room 103, looking southeast, July 1982.

Plasterboard
Walls, ca. 1940s

Bathroom Partition
← Wall, ca. 1970s

← Window Opening
+ Sash, 1902-03

Window Opening
+ Associated
Woodwork
(except sash),
ca. 1837 →

sash,
1902-03

← Window Architrave
Apron, Reused
Historic Woodwork →

Baseboard Heating Units, ca. 1960s

Carpet on Plywood,
ca. 1970s

Figure 49. Stanton House: Room 104, looking southwest, June 1982.

Partition Wall +
Doorway, 1902-03;
Plasterboard, ca. 1940s

Reused Historic
← Woodwork

Baseboard, 1902-03



Figure 50. Stanton House: Room 104, looking north, June 1982.

Plasterboard
ca. 1910s

Plasterboard Walls,
ca. 1940s

Gas Stove,
ca. 1960s

Doorway,
1902-03 →

Former
Window
Opening,
1902-03 ←

Raised ca. 1837
Ogee moulding

Wainscot, 1902-03

Linoleum Tile

Figure 51. Stanton House: Room 105,
looking northeast, June 1982.



Figure 52. Stanton House: Room 105, looking northwest, June 1982.

Plasterboard Walls,
ca. 1940s

Doorway,
1902-03 →

Modern
Telephone
← Hookup

Window
Opening,
← 1902-03

Reused ca. 1837
ogee moulding
↘

Wainscot, 1902-03

Baseboard Heating Unit, ca. 1960s

Figure 53. Stanton House: Room 105, looking southwest, June 1982.



Figure 54. Stanton House: stairway to the second story.

Interior Conditions: Second Story

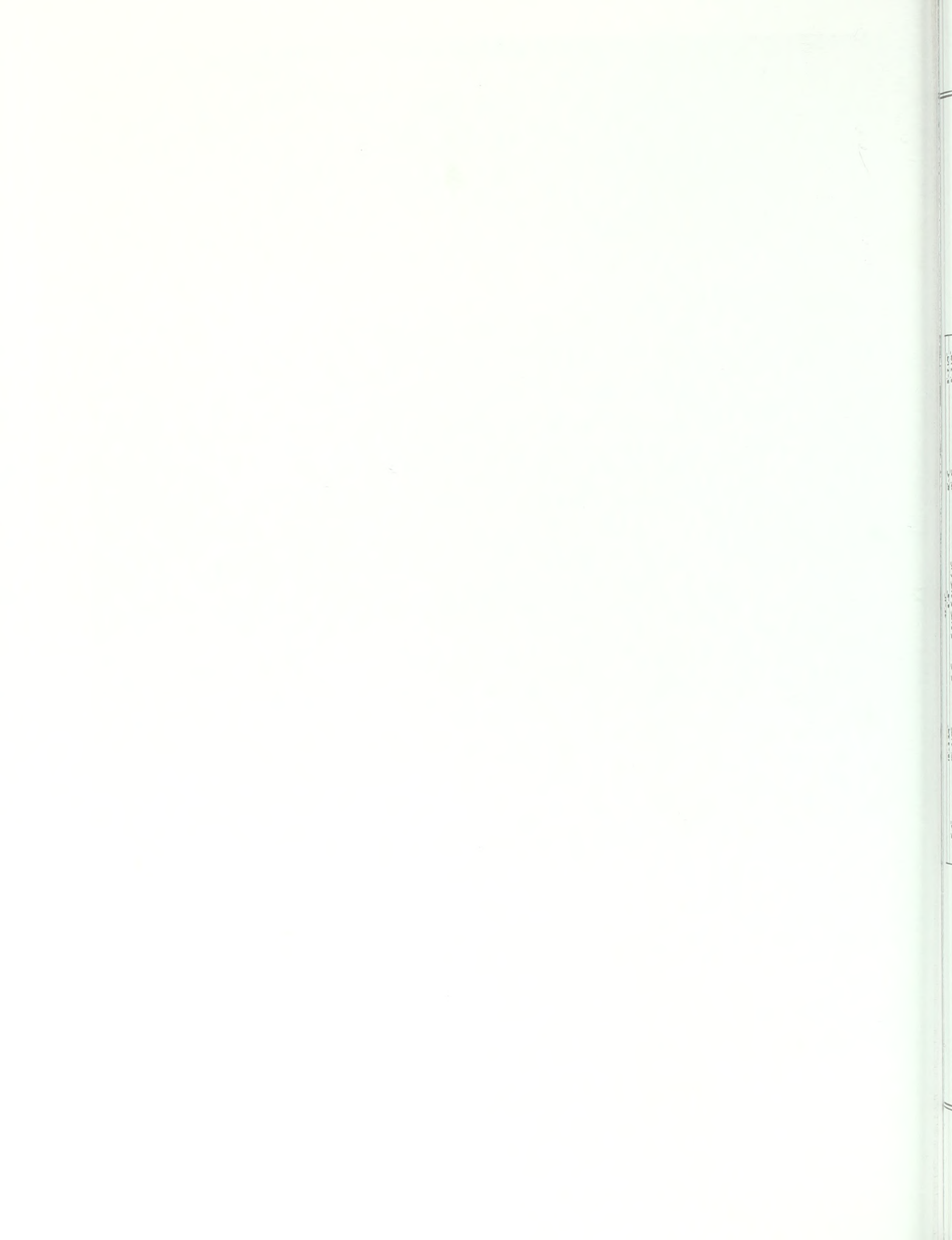

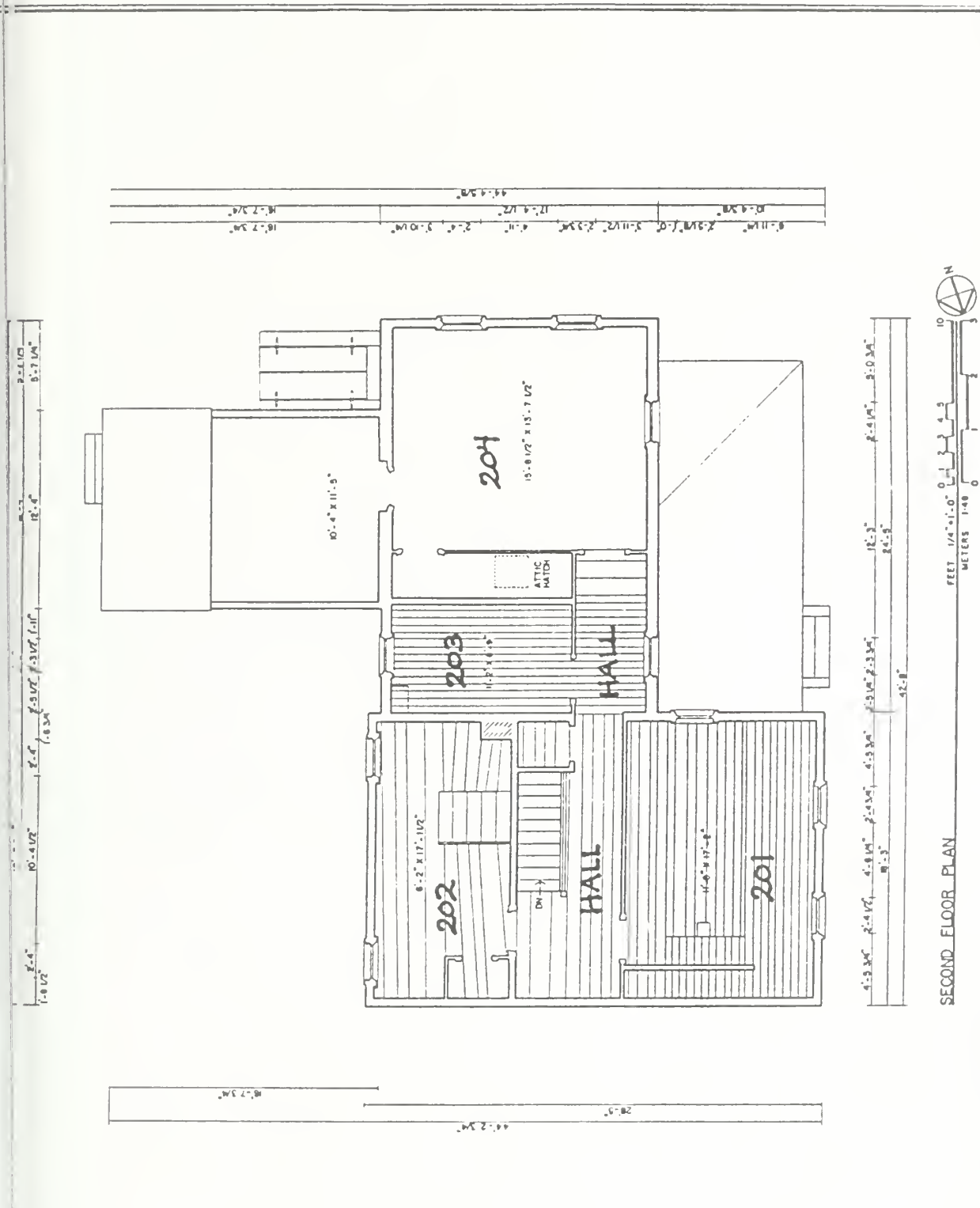

DRAWN BY: PAUL D. DOLINSKY, INKED BY: REBECCA TRUMBULL, 1982 WOMEN'S RIGHTS NATIONAL HISTORICAL PARK NATIONAL AND STATE HISTORIC LANDS SECTION NATIONAL PARK SERVICE UNITED STATES DEPARTMENT OF THE INTERIOR	32 WASHINGTON STREET SENECA FALLS	NEW YORK SENECA COUNTY	SURVEY NO. NY 6103	HISTORIC AMERICAN BUILDINGS SURVEY Sheet 4 of 7
---	--------------------------------------	---------------------------	--------------------------	---

Figure 55. Stanton House: second-floor plan, summer 1982.

Ceiling Tiles,
ca. 1970s

Closet Partition
Wall, 1902-03;
Paneling, ca.
1970s



Partition Wall, 1902-03;
Paneling, ca. 1970s

Reused ca. 1840
Newel, Railing, +
Balusters

Baseboard, ca. 1970s

Floorboards,
ca. 1830

Stairwell,
1902-03

Figure 56. Stanton House: second-story hall, looking southwest, June 1982.

Ceiling Heightened, 1902-03;
Ceiling Tiles, ca. 1970s

Upper Walls,
South Wing,
1902-03

Window
Opening,
1902-03

Bathroom Partition
Wall + Doorway,
1902-03;
Paneling, 1970s

Board Heating Unit, ca. 1900s

South Wing Floor
Heightened 1902-03;
Some Floorboards
Original, ca. 1837

Figure 57. Stanton House: second-story hall looking north, June 1982.



Figure 58. Stanton House: second-story hall. detail of braced-frame post at north wall, July 1982.



Figure 59. Stanton House: second-story hall, looking south, October 1982.

Textured Skim Coat, ca. 1970s,
On ca. 1840 Plaster Ceiling

Closet Partition Wall, 1902-03;
Paneling, ca. 1970s

Partition Wall, 1902-03;
Paneling, ca. 1970s

Door,
ca. 1970s

← Doorway Opening,
1902-03;
Architrave is ca.
1835 (reused here)

Baseboard, ca. 1830; Reused 1902-03
Floor Patch, 1902-03, at
Historic Hearth Location

Baseboard, 1902-03

Original Floorboards,
ca. 1830

Figure 60. Stanton House: Room 201, looking northeast, June 1982.

Textured Skim Coat ca. 1830
ca. 1830 Plaster Ceiling

Closest Partition Wall,
1902-03

Window Openings +
Associated
Woodwork, Ca. 1830-35

Wall Paneling,
ca. 1970s

Baseboard, ca. 1830

Baseboard Heating Unit, ca. 1960s

Original Floor boards,
ca. 1830

Former
Hearth
Location

Figure 61. Stanton House: Room 201, looking northwest, June 1982.

Plasterboard Ceiling,
Ca. 1940s

Plasterboard Wall,
Ca. 1940s

Window
Opening,
Ca. 1835;
Associated
Woodwork,
Ca. 1940s →

Closet,
Ca. 1940s

Door,
Ca. 1970s

Partition
Wall, 1902-3

Baseboard, ca. 1830

Original Floorboards, ca. 1830

Figure 62. Stanton House: Room 202, looking north, June 1982.

ca. 1940s

Window
Opening,
Ca. 1835;
Associated
Woodwork,
Ca. 1940s

Plasterboard Wall,
Ca. 1940s

Chimney,
1902-03

Baseboard, Ca. 1830

Baseboard, Ca. 1830

Original Floorboards,
Ca. 1830

Baseboard Heating Unit, Ca. 1960s

Plasterboard Heating Unit, Ca. 1960s

Figure 63. Stanton House: Room 202, looking southeast, June 1982.

Plasterboard Ceiling,
ca. 1940s

Partition Wall, 1902-03;
Plasterboard, ca. 1940s

Chimney,
ca. 1902-03

Heat Register,
1902-03

Baseboard,
ca. 1940s

Baseboard, 1902-03

Baseboard, ca. 1830

Original Floorboards,
ca. 1830

Floor Patch, ca. 1840,
at Former Stairwell, ca. 1830

Figure 64. Stanton House: Room 202, looking southwest, June 1982.

Ceiling Heightened,
1902-03;
Plasterboard, ca. 1940s

Walls
Heightened,
1902-03;

Door,
Ca. 1970s

Plasterboard,
ca. 1940s

Window
Opening,
1902-03

Reused
Sash,
6/6,
Ca. 1837

Masonite,
Ca. 1940s

Baseboard
Heater, ca. 1960s

Linoeum Floor
Covering

Figure 65. Stanton House: Room 203, looking east, June 1982.

Ceiling Heightened &
Plastered, Ca. 1902-03

Walls Heightened, 1902-03

Window Openings &
Associated Woodwork,
1902-03

Wallpaper ca. 1970s,
On 1902-03 Plaster

Floor Heightened
1902-03; Some
Original Floorboards,
ca. 1837

Window &
Opening &
Associated
Woodwork,
1902-03

Baseboard Heating
Units, ca. 1960s

Newspapers Dated
"July & August 1934"

Figure 66. Stanton House: Room 204, looking southwest, June 1982.

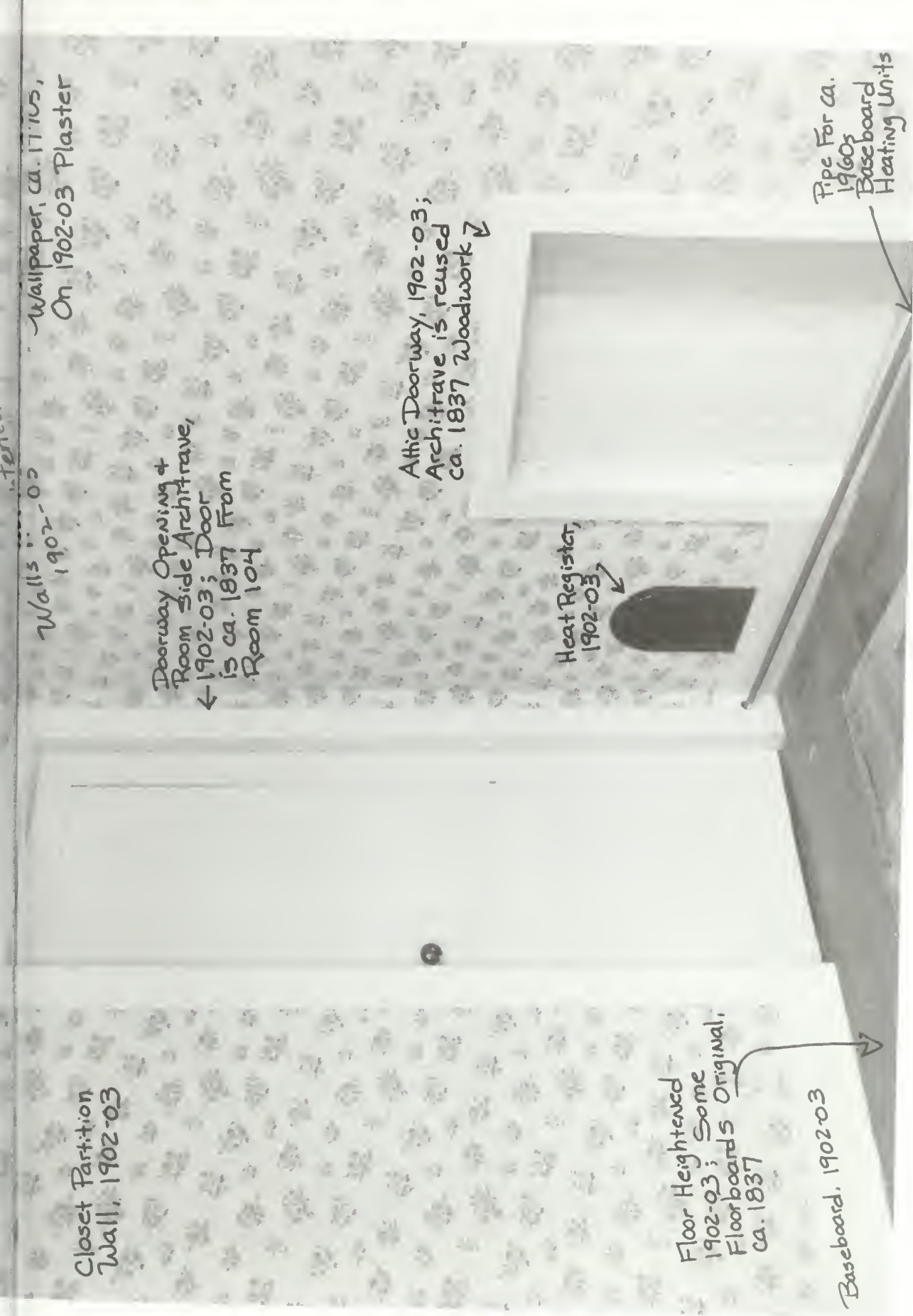

Walls, 1902-03
On 1902-03 Plaster

Closet Partition
Wall, 1902-03

Doorway Opening +
Room Side Architrave,
← 1902-03; Door
is ca. 1837 From
Room 104

Attic Doorway, 1902-03;
Architrave is reused
ca. 1837 Woodwork ↘

Heat Register,
1902-03

Pipe For ca.
1960s
Baseboard
Heating Units

Floor Heightened
1902-03; Some
Floorboards Original,
ca. 1837

Baseboard, 1902-03

Figure 67. Stanton House: Room 204, looking northeast, June 1982.

RECOMMENDATIONS

Background

General Considerations

The Stanton House and site as they exist in 1982 convey little idea of what the property looked like when Elizabeth Cady Stanton and her family lived there from 1847 to 1862. The house itself has been considerably altered over the years, and it is at present only about half the size as Mrs. Stanton knew it. Missing are the east wing, the north wing, and several porches. The site itself is also smaller, comprising roughly one quarter of the Stanton's original two acres. Gone are the boundary hedge and board fence, the outbuildings, the gardens, and Henry Stanton's fruit trees. Fortunately, however, a land-acquisition program is underway to restore the Stanton property to its original size.

One mission of Women's Rights National Historical Park is to commemorate the first Women's Rights Convention that was held in Seneca Falls in 1848. Elizabeth Cady Stanton played a major role in the convention, and it is for this reason that the National Park Service is undertaking to restore her home. However, the historical, architectural, and archeological research performed for this report did not yield sufficient information to restore all aspects of the property to the precise date "1848." The evidence does provide a ca.-1847 date for certain features or finishes. In general, though, most features and finishes can be dated only to the more general "Stanton period" spanning the years 1847 to 1862. An accurate restoration to this broader period is both possible and recommended here. Any ca.-1847 features or finishes would fall within this period, and they will be identified accordingly whenever the evidence supports it.

The following recommendations for the treatment of the Stanton House are based on four basic approaches. First, modern materials should be removed. Second, historic features should be preserved. Third, missing historic features should be reconstructed. Fourth, unobtrusive modern materials and utilities should be introduced as needed. The site and those portions of the house that are missing are discussed in the section entitled "Future Work."

Specific Considerations: Woodwork

An important component of the Stanton House restoration will be the use of the historic woodwork that was reused throughout the house during the remodeling of 1902-03. This collection was cataloged in 1982 and is included in its entirety in Appendix F of this report. Three uses of the collection are envisioned. First, items that are of significant size and in good condition, such as the closet door from Room 104, should be returned to their original locations. Second, the collection is a valuable source of information on missing architectural features and should be used in the preparation of drawings and specifications for new millwork. Third, items from the collection that are not reinstalled in the house should be saved as a reference and study collection. The collection should be stored in the Stanton House if at all possible.

It is recommended that all woodwork introduced into the house during the restoration be stamped on the back side with an identifying mark. This is especially important because a mixture of historic and reproduction woodwork is proposed for installation in the house. Thus, for example, reused historic woodwork would be stamped with its assigned catalog number such as "WORI 01 R001." New woodwork should be stamped with its date of installation such as "1984." This labeling is important so that future custodians of the house may differentiate historic woodwork from reproduction woodwork.

Site

Remove the circa-1919 frame shop/garage, the driveway, and the concrete sidewalks. Fill in the 1902-03 cistern/well to the east side of the east wing. Dig a utility trench from Washington Street to the Stanton House for electrical and telephone lines. Finally, prepare a cultural landscape report for the property.

Structural Work

Remove the following nonhistoric features from the house: the 1902-03 east wing, its 1970s shed addition, the 1902-03 porch on the front (west) side of the south wing, and the upper walls of the south wing installed in 1902-03. The roof of the south wing is historic and should be kept intact.

Stabilize the remaining post and beam frames of the historic main house and the south wing. New lumber should be installed where the old framing is missing, such as the knee braces and studs in the main house, the north end girt in the south wing, the east and west roof plates (cut for later windows) in the south wing, and the collar ties for the roof rafters in the south wing. Repair those portions of the frame that are in poor condition, using a combination of consolidation, reinforcement, and replacement. Framing members that are in good repair except for small areas of rot should be consolidated with a product such as "Seep 'N' Seal." One area where this treatment could be used is the northeast corner of the south wing's sill. All major connections in both the main house and the south wing need to be reinforced. One method that should be considered is the "Beta" system, which uses a combination of epoxy resin to consolidate the wood and fiberglass rods to impart structural stability. The advantage of this approach is that it preserves original framing members. Unfortunately, some of the framing members are very badly deteriorated and will probably have to be replaced with new wood. These areas include the northeast and southwest corner posts of the main house, the southeast and southwest corner posts of the south wing, and the south wall of the south wing. Structural reinforcing using wood or steel is also advised for the following areas: the second-story joists of the main house, the middle beam in the first story of the south wing, and the middle beam in the second story of the south wing. Structural reconstruction is suggested for one area only: the missing west porch, for which adequate photographic documentation exists.

Exterior Features

Foundation

Preserve the historic limestone foundations of the main house and the south wing. This will involve a careful inspection of the mortar joints, followed by selective repointing. In addition, one nonhistoric window opening should be infilled with limestone. This window, which was installed in 1902-03, is located in the south foundation wall of the south wing.

Siding

The need to make structural repairs necessitates the removal of all siding—both historic and nonhistoric—from the house. Several steps are involved in this procedure and the subsequent restoration of the siding, as described below.

First, remove the electrical and telephone wires that are attached to the house. Then, remove and discard the later shingle siding that was installed in the 1930s. This will expose the board siding, which should be documented both photographically and graphically. Prior to removal of this siding, the location of every component should be labeled using an indelible marker such as a wax crayon. This includes the horizontal board siding, the corner boards, and the skirt boards.

Exercise great care when removing the siding so as not to damage historic materials. Notes should be made recording nail types, evidence of previous nailings, and evidence of previous architectural features such as doorways, windows, and plaster finishes. Exterior wall cavities should be numbered sequentially and emptied of their debris into artifact bags for later study. Cover the exposed framing with sheets of heavy-grade clear plastic for protection from the weather. Make repairs to the structural framing as described in the section entitled "Structural Work."

Sort the detached siding into two categories: one for historic siding installed before 1862, and the other for nonhistoric siding installed after 1862. Historic siding may be distinguished by the presence of early paint layers and attachment with machine-cut nails having rounded points. The horizontal boards are rectangular in cross section, and the corner boards have a single bead detail. The nonhistoric siding is characterized by an absence of early paint layers, and attachment with wire nails or machine-cut nails with sheared ends. The horizontal boards installed in 1902-03 are beveled in cross section, and the corner boards are plain with no molded detail. Discard the nonhistoric siding. Salvage as much as possible of the historic siding for reinstallation. Prepare siding for reinstallation by removing paint, making repairs, and priming front and back surfaces with a white oil-base paint.

Mill new woodwork to replace the nonhistoric siding and the historic siding that is too badly deteriorated to be reused. Dimensions should be based on the surviving historic woodwork. As with the historic siding, the new woodwork should be primed on both the front and back sides.

Reinstall the historic siding materials in their original locations if possible. For example, a northeast corner board should be reinstalled in the northeast corner, and a length of north elevation board siding should be reinstalled on the north elevation. The horizontal board siding overlaps so

that the following dimensions are exposed to the weather: 4 3/4 inches on the main house, and between 4 inches and 5 1/2 inches on the south wing.

Special treatment is required where the north and east wings formerly abutted the north elevation of the main house and the east elevation of the south wing. It is proposed that a different type of siding be installed in these two locations to create a "silhouette" of the missing wings. Flush-board siding is recommended.

Doorways

Much work needs to be done on the doorways. This includes removing later doorways, reopening missing doorways, and restoring the primary entrance into the house—the front doorway. In addition, it is recommended that one nonhistoric doorway be retained.

Remove the two doorways that were added in 1902-03. One is located in the south wall of the main house, leading to the front porch. It should be restored to its original configuration as a window. The other nonhistoric doorway is in the east wall of the south wing. It should be restored as a wall surface.

Reopen the four historic doorways that were closed after 1862. Two are exterior doorways and two are interior doorways that connected the house with the missing wings. The two exterior doorways were located in the first story of the east wall of the main house. They should be fitted with glazed French doors as suggested by the architectural evidence. One of the interior doorways was located in the wall elevation of the main house and connected the main house with the north wing. Because the north wing is missing, this will now be an exterior doorway. It is recommended that this opening be adaptively used for the new heating system equipment. The other interior doorway was located in the east elevation of the south wing and connected the south wing with the east wing. Because the east wing is missing, it, too, will function as an exterior doorway. It is recommended that this doorway be used as a second means of egress from the house. The doorway will need to be fitted on its exterior side with a weatherproof door.

Restore the front doorway. This will first involve removing the later door, trim, and infill materials installed in 1902-03. Prepare millwork drawings for the door and sidelights using the exterior photograph of circa 1900. Specific measurements and molding profiles may be obtained from surviving fragments of the historic doorway cataloged as R094, R130, and R151a,b.

Retain the existing bulkhead entrance to the cellar. This is not a historic bulkhead, having been installed in 1902-03 after the east wing was removed. However, there are no plans to restore the east wing, and there is no other entrance into the cellar. In addition, the bulkhead is located unobtrusively on the back side of the house. It is therefore recommended that the bulkhead entrance be retained. The existing wood structure is in poor condition and may need to be replaced. Because it is not historic, a more durable material such as metal may be substituted for the wood.

Windows

Like the doorways, much work needs to be done on the windows. This will involve a combination of removal, preservation, restoration, and reconstruction.

Removal

Remove the 10 windows installed in the house in 1902-03. These include:

Main House

North Elevation:

- one window, first story west side (R018)*
- one window, first story east side

South Wing

West Elevation:

- two windows, second story

South Elevation:

- one window, cellar story
- two windows, first story
- two windows, second story

East Elevation:

- one window, second story (R013 and R014)*

The two windows starred with an asterisk (*) comprise historic frames and woodwork. They should be saved for reinstallation. Also, remove all window sashes from all windows. Discard the one-over-one double-hung sashes that were installed in 1902-03, and the single-light sashes that were installed in the 1970s. Save the one pair of six-over-six double-hung sashes (R013).

Preservation

Preserve the 14 historic window openings and frames that still exist in the house. Preservation work will undoubtedly require repair of the old wood. The windows include the following:

Main House

West Elevation:

- two windows, cellar story
- two windows, first story
- two windows, second story

North Elevation:

- one window, cellar story

East Elevation:

- two windows, second story

South Elevation:

- one window, second story

South Wing

West Elevation:

- two windows, first story

East Elevation:

- one window, cellar story
- one window, first story

Restoration

Restore the three window openings that were altered in 1902-03. All three windows are in the south elevation: one in the main house, and two in the south wing. The main house's window is in the first story, and was enlarged to a doorway in 1902-03. The frame and interior trim (R018) exist on the north elevation of the main house and should be reinstalled here. The two south-wing windows are in the second story; they were enlarged and relocated to a higher position in the south elevation when the wing was heightened to two stories in 1902-03. These windows should be moved back to their original positions, as seen in the exterior photograph of circa 1900. In addition, the one original frame (R014) and six-over-six sashes (R013) that exist on the east elevation should be reinstalled here.

Reconstruction

Reconstruct the window sashes. Three types and sizes of sashes will be required: small-size cellar sashes (four windows), six-over-six double-hung sashes (one window), and nine-over-six double-hung sashes (11 windows). There is no conclusive evidence as to what the historic cellar sashes looked like; the existing three-pane sashes were probably installed in 1902-03. Nonetheless, sashes will be needed in the cellar windows. It is therefore recommended that the three-pane sashes be reproduced and installed in the cellar. In addition, the wood bars on the exterior sides of the cellar-window frames should be reconstructed. One pair of six-over-six sashes exists, so only one additional pair of six-over-six sashes needs to be reconstructed. The new sashes should be an exact reproduction of the existing sashes. Reconstruction of the missing nine-over-six sashes should also incorporate details of the existing six-over-six sashes, such as glass size and muntin profiles.

Reconstruct the exterior louvered shutters for the first and second story windows and the French doorways. Three sizes will be required: the smallest to fit the two windows with six-over-six sashes, a larger size to fit 10 of the windows with nine-over-six sashes, and the largest to fit the two French doorways. Design of the shutters should be based the exterior photograph of the house dated circa 1900. Design of the shutter hardware should be based on close examination of the photograph, information obtained from the architectural investigation, and local examples of early hardware.

Reconstruct the interior Merriman-type sash springs for the 13 double-hung windows. Design of the springs should be based on the hardware remnant found in one window of Room 201, and on documentation for Merriman's patent as described elsewhere in this report. Placement of the springs should be based on the cut-outs that exist in the original window frames.

Roofs

Only two original roofs remained in 1982: on the main house and the south wing. Both preservation and restoration are recommended for these roofs. In addition, it is advised that the nonhistoric front porch roof be removed and the historic porch be reconstructed. The work required to accomplish this is outlined below.

Removal

Remove:

- the television antenna from the main house;
- the bathroom vent from the south wing;
- the asphalt roof shingles and the later (1902-03) wood shingles from the main house and the south wing;
- the later (1902-03) extensions to the roof rafters, known as "outriggers";
- the upper balloon-framed walls of the south wing, without disassembling the south-wing roof;
- the entire west porch (1902-03), including the roof; and
- the entire east wing (1902-03), including the roof.

Preservation

Preserve (i.e., save and repair where necessary):

- the original roof girts and roof rafters of the main house and the south wing; and
- the original sheathing boards of the main house and the south wing.

Reconstruction

Reconstruct:

- the missing west porch roof, using the exterior photograph of circa 1900;
- the portion of the missing east-wing roof that overlapped the south wing;
- the wood shingles; these should be the same size as the hand-rived shingles found beneath the sawn wood shingles on the main house. Install with an exposure of 6 inches to the weather.

Cornice and Gutters

No historic cornices or gutters remained in 1982, all having been replaced in 1902-03. Reconstruction of these features is therefore required. The reconstruction designs should be based on the exterior photograph of circa 1900, and on fragments of the cornice that were reused in 1902-03. The cornice fragments were cataloged as R024, R025, R128, R129, R131-142, R150, R152, and R187-189. A built-in gutter appears to have been on the west porch only.

Chimneys

Similar to the cornice and gutters, all of the historic chimneys were removed in 1902-03. It is recommended that two of these chimneys be reconstructed: the chimney in the north wall of the main house, and the chimney in the south wall of the south wing. The size and placement of the chimneys should be based on the extant framing and the exterior photograph of circa 1900. The chimneys above roof level should be constructed using bricks. The bricks should match as closely as possible the historic bricks that were reused in 1902-03 in the south wing's basement, at the stairway retaining walls and the well/cistern. These bricks are a red-orange color and measure 7 3/4 inches long by 3 5/8 inches wide by 2 1/2 inches high. Materials may be of a nonhistoric type (e.g., concrete blocks) for those portions of the chimneys that will not be visible to the public, such as in the basement and the interior walls.

Missing Wings

Two historic wings are missing from the Stanton House: the north wing, which was removed circa 1864, and the east wing, which was replaced with a smaller wing in 1902-03. All that remains of the two wings are the stone foundations that exist below grade, as discovered by the archeologists in 1980 and 1983. It is advised that these foundations be preserved; any site work done on the property should take special care not to disturb the remains. Treatment of the missing wings above grade is discussed in detail below.

The north wing was removed circa 1864, shortly after the Stanton family left Seneca Falls. It is not shown in the earliest photograph of the house dated circa 1900. It is thought to have been similar in both size and height to the south wing, based on the existing foundation and the architectural investigation. It presumably had a porch on its front side, matching the south wing. Insufficient information is available, however, to reconstruct the wing accurately. Not known are the numbers and locations of the doorways and windows, the exact placement of the chimney, and the layout and detailing of the interior. A simple treatment is therefore recommended to recall the existence of the wing, such as highlighting the north wall of the main house where the wing had been attached. This could be accomplished using a different siding material and/or paint in a color to contrast with the white siding. Another solution would be to outline the basic shape of the wing based on its known dimensions, including length, width, height, and the slope of the roof. Such an open framework could be built of wood or a metal such as aluminum.

More is known about the historic east wing removed in 1902-03. It is documented by the exterior photograph of circa 1900, which clearly shows its exterior south elevation. Plan dimensions have been taken from the photograph and the findings of the archeological investigation. Not known are the doorway and window placements in the east and north elevations, and the layout and detailing of the interior. Possible treatments to recall its existence would include the wall highlighting and the framework outline as described previously for the north wing. Alternatively, the wing could be reconstructed, if the differing professional opinions as to the dimensions of the wing can be reconciled (see the previous section "Archeological Investigations"). Sufficient information is available to create an accurate reconstruction of the foundation, the siding, the roof, the chimney, and the south elevation's doorways and windows. Those areas for which insufficient information is available, such as openings in the east and north elevations and the interior layout, could be finished in a manner that would not be confused with the historic architecture. The interior of the east wing could be adaptively used by the park for various functions such as a visitor's center, exhibits, rest room(s), and/or office space.

Interior Features

Cellar

Proposed Use and Treatment

The cellar will not be open to the public. It will be used to house the boiler and pipes for the hot-water heating system, and the halon-type gas tanks and control panel for the fire-suppression system. The collection of reused woodwork found during the restoration could also be stored here.

Although the cellar will be adaptively used, it is recommended that existing historic features be preserved. To this end, it is important to eliminate the water that accumulates in the cellar. This can be accomplished by regrading the earth outside and around the foundation, repointing and sealing the interior cellar walls, and installing a sump pump. Specific historic features that should be preserved are detailed in the following sections.

Floor

Preserve the existing historic dirt floor. Retain the existing nonhistoric concrete floor. Install a sump pump in the cellar of the main house to help eliminate seasonal flooding.

Walls

Preserve the existing historic limestone walls. Retain the 1902-03 brick partition wall between the main house and the south wing. Repair the stone walls by raking old loose mortar out of the joints and repointing with new mortar. Paint the walls with a white-pigmented masonry sealer. A sealer will function to keep water from entering the cellar; the white color will recall the historic finish of whitewash.

Ceiling

Preserve the existing ceiling except in the vicinity of the north and south chimney stacks. Here the ceiling should be divested of its nonhistoric infill materials. Chimney stacks and first-story hearths will be rebuilt in these two locations.

Doorways

Retain the doorway entrance in the east wall of the south wing's cellar. Rebuild the exterior bulkhead cover and install a door at the interior cellar entrance. The door may be one of the 1902-03 wood doors that will be removed from the house as part of the restoration.

Windows

Remove the window in the south wall of the south wing's cellar; fill the opening with stones that match the existing limestone foundation. Preserve the remaining four window openings in the main house (three) and the south wing (one). This will involve repairing the existing window frames, reconstructing the wood bars on the exterior side of the frames, and

installing reproduction window sashes. For more details on the window sashes, see the section entitled "Exterior Features: Windows."

Chimney Bases

Preserve the remnants of the historic chimney bases. These include the two brick footings in the floor of the main house's cellar, and the low stone base at the south wall of the south wing's cellar. New chimney bases for the reconstructed chimneys should be installed so as not to damage the existing historic remnants. This may be accomplished by building on either side of the brick footing, and by building carefully on top of the stone base.

Stairway

Preserve the existing steps and retaining walls at the east wall of the south wing. Replace loose and crumbling mortar with new mortar. Seal the retaining walls with a white-pigmented masonry sealer.

Heating System

Remove the existing modern gas-fueled boiler and associated pipes from the south wing's cellar. Install a new gas-fueled boiler and supply pipes in the main house's cellar.

Electrical System

Remove the existing nonhistoric light fixtures. Install new ceiling light fixtures and switches. Install an electrical control box for the house at the west wall of the main house's cellar.

Plumbing System

Remove the existing modern gas-fueled hot-water boiler and associated pipes from the south wing's cellar.

Fire-Suppression System

Install halon-type gas tanks, associated pipes, ionization detectors, and a control panel.

Finishes

Paint the walls with a white-pigmented masonry sealer following repairs to the mortar joints.

Room 101

Proposed Use and Treatment

Room 101, the front parlor, will be open for public viewing. Restoration to the period of Stanton occupancy (1847-62) is recommended.

Floor

Remove the circa-1970s wall-to-wall carpeting and the plywood base to which it is glued. Preserve the historic floorboards beneath the plywood. Remove the 1902-03 patch at the north wall to permit restoration of the chimney stack and hearth.

Walls

Remove the circa-1948 plasterboard from all the walls. Preserve the existing historic walls beneath the plasterboard. All existing layers of wallpaper on the plaster walls have been identified as nonhistoric and should be removed. Every effort should be made to save as much as possible of the original circa-1840 plaster that is distinguishable by its dark color. Retain the 1902-03 plaster that is distinguishable by its light color. Fill in the doorway opening at the east end of the south wall after this circa-1880s doorway is removed. Partially fill in the other doorway opening in the south wall after this 1902-03 doorway is restored to its historic appearance as a window opening. Fill in the 1902-03 window opening in the north wall after the historic woodwork reused here is moved back to the south wall.

Ceiling

Remove the circa-1970s dropped ceiling, which consists of a metal grid and large acoustical panels. Restore the ceiling, which is missing most of its lath and all of its plaster, with a similar plaster ceiling. Metal lath may be substituted for wood lath.

Baseboards

Remove the baseboards running across infilled historic doorway openings in the east and north walls. Preserve all remaining historic (circa-1840) baseboards. Reconstruct new baseboards for the closure of the two doorways in the south wall, and for installation on either side of the restored chimney breast at the north wall.

Doorways

Remove both doorways in the south wall. Discard both doors (1902-03) and the architrave of the interior doorway (circa 1880s). Save the circa-1840 architrave of the exterior doorway that was reused from other locations. This architrave has been cataloged as R030a,b,c.

Restore the wide doorway in the middle of the east wall. This will involve the following work:

- remove the circa-1840 mantel (R029) that was installed here in 1902-03;
- remove the baseboards, both historic and reused (R032 and R033) and modern (1902-03), that cross the former opening;
- remove the wall materials (studs, lath, and plaster) that infill the former opening; and
- fabricate and install woodwork for the doorway. Missing woodwork components include the threshold, jambs, architraves, and folding doors. Design of the architraves should be based on the existing circa-1840 architraves at the windows.

Recreate the doorway at the east end of the north wall. This will involve the following work:

- remove and save the baseboard (R027) that crosses the former opening;
- remove the wall materials (studs, lath, and plaster) that infill the opening; and
- fabricate and install woodwork for the doorway (missing woodwork components include the threshold, jambs, architraves, and paneled door; design of the architrave should be based on the existing circa-1840 architraves at the windows).

Windows

The three historic (circa-1840) windows in the room require both preservation and restoration work. Preserve the two windows in the west wall, which survive in their original locations with most of their original woodwork intact. Remove the nonhistoric (1902-03) window sashes and replace with historically accurate nine-over-six sashes. Missing features that need to be restored include the architrave plinths (removed when the baseboard heating units were installed) and the Merriman-type sash springs.

Restore the south window that was enlarged to an exterior doorway in 1902-03. The entire window, including its historic (circa-1840) woodwork, was reused at the north wall. Restoration of the window will therefore involve removing the doorway and reinstalling the window. The window woodwork has been cataloged as R018a,b,c,d,e,f. The panel below the window will need to be replastered following the move. As with the west-wall windows, the south window will need new nine-over-six sashes and Merriman-type sash springs.

Fireplace

Restore the fireplace that is missing from the north end of the room. This will involve the following work:

- remove the patch in the floor at the north wall;
- remove the patch in the ceiling at the north wall;
- remove and infill the window opening in the north wall;
- rebuild the chimney stack;
- rebuild the hearth and the firebox using bricks similar to those found to have been reused in 1902-03 in the cellar;
- apply plaster to the room side of the chimney breast and reproduction baseboards on either side of the chimney breast; and
- move the historic (circa-1840) mantel, cataloged as R029, from the east wall to its correct location as indicated by paint lines on the existing floorboards.

Heating System

Remove the circa-1960s baseboard heating units from the west and north walls. Install the fan-coil unit for the new heating system in the restored north doorway.

Electrical System

Remove all existing electrical fixtures and wiring. Install one electrical light fixture and one electrical outlet within the restored fireplace so as to be as unobtrusive as possible. Locate the light switch in the stairway closet in Room 103.

Plumbing System

Remove the pipes associated with the circa-1960s baseboard hot-water heating system.

Fire-Suppression System

Install one ionization detector, flush-mounted, in the ceiling. Also install one halon-type nozzle in one corner of the room.

Finishes

Sufficient physical evidence was found to restore the finishes in the room to the period "circa 1850s," as follows.

Cover the floor with a wall-to-wall floorcloth. Tack the floorcloth in place at the perimeter of the room. The entire floorcloth should be painted white (Munsell 5Y 9/1). A pattern was probably painted on top of this white background color historically. Unfortunately, no documentation survives of the pattern, so no attempt should be made to recreate it.

Since no historic wallpaper was found in Room 101, wallpaper the walls with a reproduction of the "circa 1850s" wallpaper found in Room 104 (layer #4).

Paint the ceiling with a white (Munsell 5Y 9/1) calcimine or a simulated calcimine paint.

Grain the woodwork to resemble oak. The base coat for the graining should be a yellow (Munsell 2.5Y 8.5/6) oil-based paint. Use reused woodwork pieces R034 and R196 as samples of the historic graining style.

Room 102

Proposed Use and Treatment

Room 102, the back parlor, will be open for public viewing. Restoration to the period of Stanton occupancy (1847-62) is recommended.

Floor

Remove the circa-1960s oak floorboards. Preserve the historic floorboards, including the floor patch, that exist beneath the oak floorboards. Patch the hole in the floor at the south wall that was made for the chimney in 1903.

Walls

Remove the circa-1970s wood paneling from the plaster walls. Remove the 1902-03 stairway enclosure, stairway, and closet from the west side of the room. Remove the wall materials (studs, lath, and plaster) from the center of the west wall in order to restore the wide parlor doorway here. Similarly remove wall materials from the east wall to reopen the two exterior doorways here. Close up the 1902-03 window opening in the north wall and the 1902-03 doorway at the east end of the south wall. Remove and save the historic layers of wallpaper preserved behind the 1903 chimney at the south wall. Remove and discard the wallpapers from all other walls in the room, which have been identified as nonhistoric (1902-03 and later). Preserve the existing circa-1840 plaster distinguishable by its dark color. Retain the 1902-03 plaster distinguishable by its light color.

Ceiling

After the 1902-03 stairway is removed, close up the stairway opening in the ceiling. Remove the circa-1970s acoustical tiles from the existing ceiling and the wood furring strips to which they are attached. Remove the two layers of ceiling wallpapers, both of which have been determined to be nonhistoric. Preserve as much of the remaining plaster ceiling as possible. This consists of both historic circa-1840 plaster and later 1902-03 plaster.

Baseboards

Discard the nonhistoric baseboards from the stairway enclosure, the south wall, the east wall, and the west wall. Preserve the historic (circa-1840) baseboards that survive in their original locations at the north wall, and at the north ends of the east and west walls. Reinstall the baseboards identified as having been reused in Room 101 in 1902-03 (cataloged as R027, 28, 32, 33, and 41).

Doorways

Remove the 1902-03 doorway to Room 103 in the south wall. (The closet doorway at the west wall will be removed along with the stairway enclosure.) Save the historic closet door (R039), which was reused here in 1902-03 from the second story. Retain the existing doorway opening at the west end of the south wall, now used as the doorway to the 1902-03 stairway. Recreate the wide parlor doorway in the west wall and the two exterior doorways in the east wall. Specific work required for each of the four historic doorways is detailed below.

South Doorway

Retain the existing opening, but remove the nonhistoric woodwork.

Reinstall the original left- and right-side architraves, cataloged as R030a (left) and R030b (right).

Fabricate and install all missing woodwork, including the jambs, top architrave, and door. The door should have four panels, similar to two doors cataloged as R039 and R063. It should be hung on the east side to swing into the room.

West Doorway

Reopen the wall to restore the original wide opening.

Fabricate and install all missing woodwork, including the threshold, jambs, architrave, and doors. The style of the architrave should match the existing circa-1840 window architraves in Room 101. Two paneled bi-fold doors are recommended as an appropriate historical design.

East Exterior Doorways

Reopen the wall to restore the two original doorway openings. (The south opening was converted to a window.)

Reinstall the top architrave that was reused in 1902-03 (cataloged as R030b).

Fabricate and install all missing woodwork, including the thresholds, jambs, remaining architraves, and doors. Paired French doors are recommended for each opening.

Windows

Remove the two 1902-03 windows: one in the north wall and one in the east wall.

Heating System

Remove the 1903 brick chimney from the south wall and the obsolete metal heat register from the floor. Also remove the circa-1960s baseboard heating units from the north and east walls, and the pipes to the second story in the southeast boxed corner. The room will be heated indirectly, as it was historically, by the heating unit in the front parlor, Room 101. Install a thermostat for the new heating system on the south wall of the room.

Electrical System

Remove all existing electrical fixtures and wiring. No modern electrical equipment will be installed in this room.

Plumbing System

Remove the pipes associated with the circa-1960s baseboard hot-water heating system.

Fire-Suppression System

Install an ionization detector, flush-mounted, in the ceiling. Also install one halon-type nozzle in one of the corners of the room.

Finishes

Room 102 should be finished the same as Room 101. See the "Finishes" section for Room 101 for recommendations. Also, carefully remove and separate the multiple layers of wallpaper preserved on the south wall behind the 1903 chimney. Encapsulate each layer in clear mylar sheets.

Room 103

Proposed Use and Treatment

Room 103, the entry and stair hall, will be open for public viewing. Restoration to the period of Stanton occupancy (1847-62) is recommended.

Floor

Remove the circa-1960s oak floorboards. Preserve the original floorboards that exist beneath the oak floorboards. Also preserve the still-visible outlines of the missing historic partition walls and stairway.

Walls

Remove the 1902-03 south partition wall. Also remove the circa-1948 plasterboard and the 1902-03 wood lath beneath it covering the north, east, and west walls of the room. Infill the two nonhistoric doorway openings in the north wall, as described below. Rebuild the south partition wall in its original location, approximately 4 feet north of the 1902-03 partition. Replaster the walls on metal lath.

Ceiling

Remove the circa-1948 plasterboard and the 1902-03 wood lath above it. Also remove the 1902-03 ceiling joists from the east half of the room to permit restoration of the historic (circa-1840) stairway. Lower the entire ceiling approximately 12 inches to its original height. Replaster the west half of the ceiling on metal lath.

Baseboards

Remove the existing baseboards, all of which date to the remodeling of 1902-03. Fabricate new baseboards to replicate the section of original baseboard (R108) that was found in a reuse location in 1982.

Doorways

Remove and infill the two nonhistoric doorways in the north wall: one at the west end (circa 1880) and one at the east end (1902-03). The doorway in the south partition wall will be removed along with the partition. Remove the 1902-03 woodwork from the two remaining historic doorways: the exterior doorway in the west wall, and the interior doorway in the center of the north wall. Restore the four historic doorways in the room as follows.

Exterior West Doorway

Remove the existing 1902-03 woodwork.

Widen the doorway opening to fit the two historic sidelights.

Fabricate and install new woodwork, including the threshold, jambs, architraves, door, sidelights, and panels below the sidelights. The design of the door and the sidelights should be based on the exterior photograph of circa 1900. The design of the architrave should be based on surviving examples of historic doorway architraves on the first story, south wing.

Interior North Doorway

Remove the existing 1902-03 woodwork.

Fabricate and install new woodwork, including the jambs, architraves, and door. The door should be hung on the Room-102 side of the doorway. The style of the jambs and the architraves should be based on Room-103 doorway fragments reused in 1902-03 including R021; R043a,c; R045; R062c; R093a,b; and R113.

Interior South Doorway

Reconstruct the doorway opening in the rebuilt south partition wall; its exact location and width should be based on the outlines of the doorway preserved on the original floorboards.

Fabricate and install new woodwork, including the threshold, jambs, architraves, and door. The style of the jambs should be based on jamb fragments R107, R112, R114, and R115. The style of the architraves should be based on Room-103 architrave fragments R043a,c; R045; and R062c. The door should have four panels similar to the original closet door from Room 104 (R063).

Stairway Closet Doorway

Reconstruct the stairway closet and doorway at the same time the stairway is reconstructed. Position the closet and closet doorway beneath the upper run of the stairway, based on the marks preserved on the floorboards.

Reinstall architrave pieces R088, R099, and R116.

Fabricate and install new woodwork, including the threshold, jambs, missing pieces of architrave, and door. The door should be hung on the north side to swing out into the room. Its appearance is not known; however, a typical Greek Revival design for circa 1840 would have been two vertical panels.

Windows

Preserve the historic window opening in the east wall. Remove the 1902-03 woodwork and sashes. Fabricate and install new woodwork, including the casing, architrave, stool, and apron. The style of the architrave should be based on the reused pieces that were cataloged

as "R096, 168, 173, 174, and 175. Fabricate and install nine-over-six sashes and a Merriman-type sash spring.

Stairway

Design and reconstruct the missing circa-1840 stairway to the second story at the east end of the room. Design of the stairway should be based on the physical evidence, including the outlines on the floorboards, the marks of the landing on the east window's architrave, and the stairway fragments that were reused in 1902-03. Each reused fragment should be assessed as to its condition and reinstalled if at all possible. The following stairway elements are available for the reconstruction:

- treads and risers: R185 and R194;
- landing floorboards: R006, R009, R071, and R126;
- landing baseboards: R001 and R161;
- railing components: R046 through R052; and
- miscellaneous trim: R072, R106a, R121, R122, R124, R125, R155, R170, and R177.

Heating System

Remove the modern baseboard heating units from the east and west walls. No heating system will be installed in this room; it will be heated indirectly by the unit in Room 104.

Electrical System

Remove all existing electrical fixtures and wiring. Install modern electrical fixtures within the reconstructed stairway closet. These fixtures should include one light, one light switch, and one electrical outlet. Two additional light switches are also recommended: one to control the light in Room 101, the other to control the light in Room 201.

Plumbing System

Remove the pipes that service the nonhistoric (1902-03) bathroom on the second story. These pipes are located in the northeast boxed corner of the room. Also remove the pipes that are associated with the circa-1960s baseboard hot-water heating system.

Fire-Suppression System

Install a halon-type nozzle in a corner of the room. Also install an alarm pull station and a halon pull station within the stairway closet.

Finishes

Sufficient physical evidence was found to restore the finishes in Room 103 to the period "circa 1850s," as follows.

Cover the floor with a wall-to-wall floorcloth. Tack the floorcloth in place at the perimeter of the room. The entire floorcloth should be painted white (Munsell 5Y 9/1). A pattern was probably painted on top of the white background color historically. Unfortunately, no documentation survives of the pattern, so no attempt should be made to recreate it.

Wallpaper the walls with a reproduction of the "circa 1850s" wallpaper and flocked border (layer #3). Scraps of this paper were found in Room 103; larger pieces of it were found in Room 203 and discarded under the front porch.

Paint the ceiling with a white (Munsell 5Y 9/1) calcimine or a simulated calcimine paint.

Paint the woodwork, except for the stairway railing and newel, with a white (Munsell 5Y 9/1) oil-based paint. The railing and newel should be finished with varnish and/or lacquer.

Room 104

Proposed Use and Treatment

Room 104, the sitting or dining room, will be open for public viewing. Restoration to the period of Stanton occupancy (1847-62) is recommended.

Floor

Remove the yellow wall-to-wall carpeting (circa 1970s) and the nonhistoric (circa-1960s) oak floorboards to which the carpeting is glued. Preserve the existing historic floorboards beneath the later oak floorboards. Remove the later (1902-03) patch from the center of the south end of the room to permit the reconstruction of the historic chimney stack and the fireplace hearth. Repair the historic floorboards where they were damaged by later heating and plumbing fixtures.

Walls

Remove the 1902-03 north partition wall and the circa-1948 bathroom partition walls in the southeast corner of the room. Preserve the original (circa-1837) plaster that survived by being covered by the north partition wall. Remove the circa-1970s plasterboard and the 1902-03 lath beneath it. Close up the 1902-03 doorway opening in the east wall and the two windows in the south wall (both 1902-03; one altered circa 1970s). Reconstruct the north partition wall in its original location, 4 feet to the north of the later one. Also reconstruct the partition walls at the south end of the room to recreate the historic southeast stairway enclosure and southwest closet. Evidence for the placement of all partitions is preserved on the historic floorboards. Plaster all the walls on metal lath.

Ceiling

Remove the circa-1948 plasterboard and the 1902-03 lath beneath it. Lower the ceiling approximately 12 inches to its historic height. Reopen the ceiling at the south wall to permit the reconstruction of the southeast stairway and fireplace chimney. Plaster the remainder of the ceiling on metal lath.

Baseboards

Remove all baseboards from the room, saving only those from the south wall (R007 and R008). Reinstall R007 and R008 following restoration of the walls. Also reinstall R003, R003, R004, and R015, removed from other rooms in the house. Fabricate and install new baseboards to fill in missing areas.

Doorways

Remove all three nonhistoric doorways in the room. These include the north doorway (1902-03), the east doorway (1902-03), and the bathroom doorway (circa 1970s). Save the historic woodwork fragments that were cataloged as part of the reuse collection. Reconstruct the four missing historic doorways as follows.

North Doorway

Recreate the doorway opening in the rebuilt north partition wall; its exact location and width should be based on the outlines of the doorway preserved on the original floorboards.

Fabricate and install new woodwork, including the threshold, jambs, architraves, and door. The appearance of the woodwork should be based on the following reused woodwork: jambs (R107, R112, R114, R115), architraves (R020; R022; R057; R062a,b; R119), and door (R063).

East Doorway

Reconstruct the doorway opening in the east wall; its location should correspond to the original floorboards that continue under the infilled opening in the wall.

Fabricate and install new woodwork as specified above for the north doorway.

Install a modern door on the exterior side of the opening to protect the interior door. This is necessary because the historic east wing is missing, making this an exterior doorway.

Southeast Stairway Doorway

Recreate the doorway opening in the rebuilt south partition wall; its exact location and width should be based on the outlines of the doorway preserved on the original floorboards. The height of the doorway should be based on the left jamb (R102), which was found reused on the second story.

Reinstall the original left jamb (R102).

Fabricate and install new top and right jambs and other woodwork as specified for the north doorway. The appearance of the architraves on the interior side of the doorway should be plain, as evidenced by R090 and R181.

Southwest Closet Doorway

Recreate the doorway opening in the rebuilt south partition wall; its exact location and width should be based on the outlines of the doorway preserved on the original floorboards.

Reinstall the original jambs (R064a,b,c) and the original four-panel door (R063).

Fabricate and install new woodwork, including the threshold and architraves. See the north and southeast doorways for details.

Fabricate and install new door hardware, including two hinges and a spring-bolt latch.

Windows

Remove both windows in the south wall, which date to 1902-03. (The window at the east end was remodeled in the 1970s when the modern bathroom was installed.) Retain and restore the two historic windows in the west wall as follows.

West Wall, South End

Remove the 1902-03 window stops and window sashes. The nonhistoric stops are those on the top and right side.

Preserve the existing historic woodwork, including the architrave, the stool and apron, and the left window stop.

Fabricate and install right and top window stops that match the original left-side window stop. Also fabricate and install new nine-over-six sashes and a Merriman-type sash spring.

West Wall, North End

Remove all of the existing woodwork, which dates to 1902-03.

Fabricate and install reproduction woodwork based on the historic woodwork at the south-end window and reuse fragments R005, R056, R082, R092, R095, and R117. Also fabricate and install new nine-over-six sashes and a Merriman-type sash springs.

Stairway

Reopen the stairway opening in the ceiling by removing the 1902-03 infill materials. Design, fabricate, and install a steep stairway within the southeast enclosure. The stairway should be simple in design with open risers. The width of the stairway and the angle of ascent will be dictated by the size of the enclosure and the height of the second story.

Fireplace

Restore the fireplace that is missing from the south end of the room. This will involve the following work:

- remove the 1902-03 patch in the floor at the south wall;
- remove the 1902-03 patch in the ceiling at the south wall;
- rebuild the chimney stack, concealed behind the rebuilt south partition wall;
- rebuild the hearth and firebox using bricks that are similar in appearance to the historic bricks reused in the cellar in 1902-03; and
- design, fabricate, and install a mantel (two of the mantel's historic side pieces, R065a and b, should be used in the restoration design).

Heating System

Remove the circa-1960s baseboard heating units from the south and west walls of the room. Install a new fan-coil heating unit in the southwest closet.

Electrical System

Remove all existing electrical fixtures and wiring. Install three new electrical fixtures: one light, one light switch, and one outlet. Locate the light in the firebox of the fireplace, and the light switch and outlet in the storage closet.

Plumbing System

Remove the plumbing fixtures from the circa-1970s bathroom in the southeast corner of the room. These include a sink, a toilet, and a shower. Also remove the pipes associated with the circa-1960s baseboard hot-water heating system. Patch/repair the floor where necessary.

Fire-Suppression System

Install an ionization detector and a halon-type gas nozzle in one corner of the room. Install a second ionization detector in the southwest closet. The detectors should be flush-mounted in the ceiling. Also install an automatic telephone dialer for both the fire-suppression and the intrusion alarm system in the southwest closet.

Finishes

Sufficient physical evidence was found to restore the finishes in Room 104 to the period "circa 1847," as follows.

Cover the floor of the room with a wall-to-wall floorcloth. Tack the floorcloth in place at the perimeter of the room. The entire floorcloth should be painted yellow (Munsell 2.5Y 7/6). A pattern was probably painted on top of the yellow background historically. Unfortunately, no documentation survives of the pattern, so no attempt should be made to recreate it. Paint the floor in the southeast stairway enclosure and the southwest closet with an oil-based paint matching the yellow color of the floorcloth.

Wallpaper the walls with a reproduction of the "circa-1847" wallpaper. Samples of this wallpaper were preserved at the west wall behind the later (1902-03) partition wall and under the front porch. All wallpaper layers should be removed from the wall and preserved by encapsulation in clear mylar.

Paint the ceiling with a white (Munsell 5Y 9/1) calcimine or a simulated calcimine paint.

Grain the woodwork to resemble quartered oak. The base coat for this graining should be a cream color (Munsell 5Y 9/2) oil-based paint. Samples of the graining style are preserved on woodwork jamb pieces R109, R110, and R111. It is also recommended that the graining be exposed on the original four-panel door, R063. This may be accomplished by using a chemical paint stripper to remove the later layers of paint.

Room 201

Proposed Use and Treatment

Room 201, the front bedroom, will be open for public viewing. Restoration to the period of Stanton occupancy (1847-62) is recommended.

Floor

Preserve the existing historic floorboards. Remove the 1902-03 patch at the north wall to permit the restoration of the fireplace chimney and hearth.

Walls

Remove the imitation-wood paneling that was installed sometime in the 1970s. Also remove the north (closet) and east partition walls built in 1902-03. Preserve the historic (circa-1840) plaster that survives on the north, west, and south walls. Rebuild the north (closet) and east partition walls in their correct historic locations, as indicated by outlines on the original floorboards and patches in the ceiling plaster. Finish these walls with plaster on metal lath. Close up the opening at the east end of the south wall, which was created for the 1902-03 hallway.

Ceiling

Repair the plaster ceiling where it was damaged by the north and east partition walls installed in 1902-03. Remove the skim coat of circa-1970s textured plaster from the rest of the ceiling. Preserve the historic (circa-1840) plaster beneath the skim of later plaster. Remove the infill materials from the ceiling at the north end of the room as part of the chimney restoration.

Baseboards

Preserve the historic baseboards at the west and south walls. Reinstall the reused historic baseboards cataloged as "R010, R154, R156, R158, and R165." Fabricate and install new baseboards to fill in areas where baseboards are missing.

Doorways

The two existing doorways in the 1902-03 north and east partition walls will be removed along with those partitions. Save the historic woodwork fragments that were cataloged as part of the reuse collection. Restore the three missing historic doorways as follows.

East Doorway

Recreate the historic doorway opening at the south end of the rebuilt east partition wall.

Reinstall the complete jamb (R104a,b,c), the complete architrave on the side facing Room 201 (R060a,b,c), and the four-panel door (R039).

Fabricate and install a new threshold, Norfolk latch hardware, and two hinges. Design of the Norfolk latch should be based on the silhouette preserved on the door. Design of the hinges should be based on the early hinge cataloged as R069.

Northwest Closet Doorway

Recreate the historic doorway opening at the west end of the rebuilt north partition wall. Its exact location can be determined from an outline of the threshold on the original floorboards.

Fabricate and install new woodwork, including a threshold, jambs, architraves, and door. The appearance of the jambs should be based on reuse pieces R105a,b,c. The appearance of the architrave should be based on reuse pieces R103a,b. The door should have four panels similar to the old door in the east doorway, R039.

Northeast Closet Doorway

Recreate the historic doorway opening at the east end of the rebuilt north partition wall. Its exact location can be determined from an outline of the threshold on the original floorboards.

Fabricate and install new woodwork, including a threshold, jambs, architraves, and door. The appearance of the jambs should be based on reuse pieces R179, R191, and R192. The appearance of the architraves should be based on reuse pieces R016 and R159. The door should have four panels similar to the old door in the east doorway, R039.

Windows

Preserve the three existing historic windows in the west and south walls, including their architraves, stools, aprons, the top window stops, and the right-side window stop of the northwest window. Remove the remaining window stops and 1902-03 sashes. Fabricate and install new nine-over-six window sashes, window stops, and Merriman-type sash springs.

Fireplace

Restore the fireplace that is missing from the north end of the room. This will involve the following work:

- remove the patch in the floor;
- remove the patch in the ceiling;
- reconstruct the chimney stack, which will be concealed behind the north partition wall;
- reconstruct the hearth and firebox using bricks; and
- fabricate and install a new fireplace mantel (lacking any physical evidence of the mantel, the design should be based on the two early mantels that survive in Rooms 101 and 104, and should be simple, given the second-story location).

Closet Shelves

Install wood shelves in the northwest closet. The number and exact placement of the shelves can be determined from marks preserved in the original plaster.

Heating System

Remove the circa-1960s baseboard heating units from the west and south walls. Install a new fan-coil unit in the rebuilt northeast closet.

Electrical System

Remove all existing electrical fixtures and wiring. Install one new light and one outlet. Conceal both in the restored fireplace firebox. Locate the switch for the light in the rebuilt stairway enclosure in Room 103.

Plumbing System

Remove the pipes associated with the circa-1960s baseboard hot-water heating system.

Fire-Suppression System

Install an ionization detector and a halon-type gas nozzle in the room. Install a second ionization detector, an alarm pull, and a horn alarm in the northeast closet. The ionization detectors should be flush-mounted in the ceiling.

Finishes

Sufficient physical evidence was found to restore the finishes in Room 201 to the period "circa 1847," as follows:

- paint the floorboards with a yellow (Munsell 2.5Y 7/6) oil-based paint;
- wallpaper the walls with a reproduction of the "circa-1847" wallpaper, samples of which were found in Room 202 behind the later chimney and loose beneath the front porch;

- paint the ceiling with a white (Munsell 5Y 9/1) calcimine or a simulated calcimine paint; and
- paint the woodwork with a white (Munsell 5Y 9/1) oil-based paint.

Room 202

Proposed Use and Treatment

Room 202, the back bedroom, will be open for public viewing. Restoration to the period of Stanton occupancy (1847-62) is recommended.

Floor

Remove the 1902-03 stairway; save the newels, railing, and balusters that were reused from the circa-1840 stairway in Rooms 103-203. Patch the stairway opening in the floor with floorboards. Remove the chimney from the south end of the room, and likewise patch the opening in the floor. Preserve the existing floorboards, including the patch for an earlier stairway that was removed circa 1840.

Walls

Remove the west partition wall and the adjacent hall closet, both dating to 1902-03, and the circa-1940s north closet. Remove the circa-1948 plasterboard and circa-1970s imitation-wood paneling from the remaining walls. Remove the 1902-03 infill materials from the south wall in order to recreate the historic doorway to the south wing. Preserve the circa-1837 lath that exists at the north, east, and south walls beneath the plasterboard. Also preserve the circa-1837 lath with circa-1840 plaster that survives at the south wall behind the 1903 chimney. Reconstruct the west partition wall in its correct historic location, based on outlines on the floor and a long patch in the ceiling. Plaster all the walls (except the small area of original plaster) on metal lath.

Ceiling

Remove the circa-1948 plasterboard and wood furring strips from the ceiling. Repair the damage caused by removal of the plasterboard and later partition walls. Patch over the hole for the 1903 chimney. Preserve the remaining historic (circa-1840) lath and plaster.

Baseboards

Preserve the baseboards that survive in their original locations at the east end of the room. These baseboards are found at the south half of the east wall, the east half of the south wall, and the east end of the north wall. Remove the remaining nonhistoric baseboards. Fabricate and install new baseboards following the removal of the nonhistoric walls and the reconstruction of the historic west wall.

Doorways

All of the existing doorways, none of which are historic, will be removed along with the nonhistoric partitions. These include the 1902-03 doorway in the west partition wall, the 1902-03 doorway to the hall closet, and the circa-1940s north closet doorway. Some of these doorways incorporated woodwork from earlier historic doorways that should be saved; these pieces were cataloged as part of the reuse collection. Recreate the two missing historic doorways as follows.

South Doorway

Remove the studs, lath, and plaster that were installed in 1902-03 to infill the opening.

Reinstall the threshold (R076), the jambs (R075a,b,c), and the architrave (R058, R180, R195).

Fabricate and install a short length of architrave to patch the incomplete architrave header (R195).

Fabricate and install a new door that is similar in style to the historic four-panel door, R039. This door should be hung with two hinges on the east side and swing into Room 202.

West Doorway

Recreate the historic doorway opening at the south end of the rebuilt west partition wall.

Reinstall the complete jamb (R104a,b,c) and the complete architrave (R055a,b,c). Also reinstall the door (R039) on the Room 201-side of the doorway.

Fabricate and install a threshold.

Windows

Preserve the two historic window openings in the east wall. Remove the circa-1940s woodwork, including the architraves, sills, aprons, sash stops, and sashes. Fabricate and install new woodwork based on the surviving historic woodwork at the windows in Room 201. Also fabricate and install nine-over-six window sashes and Merriman-type sash springs.

Heating System

Remove the 1903 brick chimney from the south wall and the obsolete metal heat registers from the west partition wall. Also remove the circa-1960s baseboard heating units from the east and south walls. No modern heating equipment will be installed in this room.

Electrical System

Remove all existing electrical fixtures and wiring. No modern electrical equipment will be installed in this room.

Plumbing System

Remove the pipes associated with the circa-1960s baseboard hot-water heating system.

Fire-Suppression System

Install one ionization detector and one halon-type gas nozzle in Room 202. The detector should be flush-mounted in the ceiling, and the nozzle located in a corner of the room.

Finishes

Sufficient physical evidence was found to restore the finishes in Room 202 to the period "circa 1850s," as follows:

- paint the floorboards with a yellow (Munsell 2.5Y 7/6) oil-based paint;
- wallpaper the walls with a reproduction of the "circa-1850s" wallpaper, samples of which were found on the south wall behind the 1903 chimney and loose beneath the front porch.
- carefully remove the layers of wallpapers on the wall, separate them, and encapsulate them in clear mylar;
- paint the ceiling with a white (Munsell 5Y 9/1) calcimine paint or a simulated calcimine paint; and
- paint the woodwork with a white (Munsell 5Y 9/1) oil-based paint.

Room 203

Proposed Use and Treatment

Room 203, the upper stair hall, will be open for public viewing. Restoration to the period of Stanton occupancy (1847-62) is recommended.

Floor

Lower the entire floor approximately 12 inches to its original position. Open up the floor of the east (bathroom) part of the room in order to restore the circa-1840 stairwell. This will involve removing the existing bathroom walls, fixtures, linoleum, floorboards, and the floor joists used to infill the opening in 1902-03. Also remove the floorboards from the west (hall) part of the room that were laid in 1902-03. Cull out and reinstall any reused historic floorboards. Fabricate and install new floorboards to fill in the areas of missing floorboards.

Walls

Remove all modern materials from the walls, including masonite, plasterboard, and imitation-wood paneling. Also remove the 1902-03 wall materials: the partition between the bathroom and the hall, the south walls of both areas, the wood wainscot in the bathroom, the upper portions of the east and west walls added to heighten the ceiling, and the lath and plaster covering the historic north doorway to Room 202. Preserve the small section of historic lath and plaster that survives on the lower east side of the north wall.

Close up the opening in the north wall that was opened in 1902-03 for the new hallway. Reconstruct the south partition wall in its correct historic location, based on the absence of plaster stains on the east and west roof girts. (The partition should align with the rebuilt partition between Rooms 103 and 104 on the first story.) Plaster all the walls on metal lath.

Ceiling

Remove the circa-1948 plasterboard in the east bathroom, the circa-1960s acoustical ceiling tiles in the hall, and the 1902-03 lath and plaster above these materials. Restore the original configuration of the ceiling by removing the later joists and lowering the roof to its original height. Plaster the ceiling on metal lath.

Baseboards

Remove and discard all the existing baseboards, which were installed in 1902-03. Reinstall the historic (circa-1840) baseboards that were cataloged as R002, R097, R098, and R176. Fabricate and install new baseboards similar in style to the historic baseboards to fill in areas of loss.

Doorways

The 1902-03 doorways between the bathroom and the hall, and from the hall to Room 204, will be removed along with the partitions in which they are located. Save all woodwork pieces identified as having been reused in 1902-03. Restore the two historic doorways as follows.

North Doorway

Remove the 1902-03 studs, lath, plaster, and wainscot that are covering over the opening.

Reinstall the historic jamb and threshold as described for the south doorway in Room 201. Also reinstall the east side architrave (R073).

Fabricate and install architraves for the west side and top of the doorway, based on the historic example R073.

South Doorway

Recreate the doorway at the same time as the south partition wall. Position the doorway in the center of the wall.

Fabricate and install a new threshold, jambs, architrave, and door. Design of the architrave should be based on historic architrave fragments R067a,b,c. Design of the door should be based on the existing four-panel door R039. Placement of the door should be on the Room-204 side of the opening.

Windows

There were no windows in Room 203. The window in the east wall of the stairway is described in connection with Room 103.

Stairway

Design and reconstruct the stairway to the first story as described for Room 103. Restore the balustrade that provided a barrier between the stair hall and the stairwell. Reinstall the components that existed in 1986, including:

- three posts: R046, R049, R050a
- two lengths of hand rail: R048, R050b
- 14 balusters: R047b

Fabricate and install woodwork to fill in the areas of missing balustrade, such as portions of the hand rail and balusters.

Heating System

Remove the obsolete 1902-03 heat register from the east wall of the bathroom. Also remove the 1960s baseboard heating units from the east wall of the bathroom and the west wall of the hall. No modern heating equipment will be installed in Room 203.

Electrical System

Remove all existing electrical fixtures and wiring from the bathroom and hall areas. No modern electrical fixtures will be installed in Room 203.

Plumbing System

Remove all plumbing fixtures in the 1902-03 bathroom. Plumbing fixtures include a sink, a toilet, and a bathtub fitted with a shower head. Also remove the pipes associated with the circa-1960s baseboard hot-water heating system.

Fire-Suppression System

Install one ionization detector and one halon-type gas nozzle. The detector should be flush-mounted in the ceiling.

Finishes

Multiple layers of wallpaper were found in Room 203 attached to a small area of the north wall. Analysis of these indicated that Room 203 was finished identically to Room 103, except that the floor was painted yellow (Munsell 2.5Y 7/6). This is understandable, since they were the lower and upper portions of the same stair hall.

It is recommended that the multiple layers of wallpaper be carefully removed, separated, and encapsulated in clear mylar.

Room 204

Proposed Use and Treatment

Room 204, the south bedroom, will be open for public viewing. Restoration to the period of Stanton occupancy (1847-62) is recommended.

Floor

Lower the entire floor approximately 12 inches to its original position. Open up the floor at the south end of the room to permit the restoration of the southeast stairway and the south chimney stack. Remove all the floorboards, cull out and reinstall the historic floorboards, and install new floorboards to fill in areas of missing floorboards.

Walls

Remove the wall materials that date to 1902-03: the north wall of the room; the walls of the north closet; the upper portions of the east, west, and south walls; and the lath and plaster. Recreate two window openings in the south wall for the two missing historic windows. Reconstruct the north partition wall in its correct historic location, based on the absence of historic plaster stains on the east and west roof girts. Plaster the walls on metal lath.

Ceiling

Remove the plaster, lath, and ceiling joists that were installed in 1902-03. Also remove the 1902-03 hatch in the closet ceiling that was the access to the attic. Restore the configuration of the ceiling by lowering the roof to its original height. Frame an opening at the south end of the ceiling for the chimney stack. Plaster the ceiling on metal lath.

Baseboards

Remove all baseboards in the bedroom and closet. Save those baseboards identified as having been reused from other locations in 1902-03. Reinstall the historic baseboards, cataloged as R061, R153, R160, R164, R171, and R172. Fabricate and install new baseboards where necessary.

Doorways

Remove the four nonhistoric doorways that were installed in 1902-03. These include the north doorway from the hall, the north closet doorway, the small doorway in the east wall to the attic of the 1902-03 east wing, and the attic hatch in the ceiling. These later doorways incorporated woodwork from missing historic doorways that should be saved. The closet door (R063), for example, is historic and belongs in Room 104.

Recreate the north doorway to the hall at the same time as the north partition wall. Fabricate and install new woodwork, including a threshold, jambs, architrave, and door. Design of the architrave should be based on woodwork fragments R036 and R037. Design of the door should be similar to R039, with four panels. Install the door so as to swing into Room 204.

Windows

Remove the three existing 1902-03 windows in the west and south walls. Recreate the two historic windows in the south wall, which are documented by the exterior photograph of circa 1900. These were located lower in the south wall than the two windows that were installed in 1902-03. Restoration of the windows will involve the following work:

- remove the wall materials to restore the two window openings;
- reinstall the one historic frame (R014) and six-over-six sashes (R013) that were reused in the 1902-03 bathroom;
- fabricate and install new woodwork, including a second frame, sashes, window stops, architraves, stools, and aprons; and
- fabricate and install Merriman-type sash springs, one for each window.

Stairway

Restore the stairway opening in the floor at the east end of the south wall. Design, fabricate, and install a balustrade for the north edge of the opening. Because no evidence survives of this balustrade, its design will be conjectural. See Room 103 for a description of the stairway itself.

Chimney

Reconstruct the chimney that is missing from the south end of the room. Its size should be based on the framing evidence in the floor and in the roof. Finish the chimney with plaster similar to the walls. Although it is likely that a stovepipe hole existed in this chimney, no conclusive proof exists. It is therefore advised not to recreate this feature.

Heating System

Remove the obsolete 1902-03 heat register from the east wall. Also remove the circa-1960s baseboard heating units from the east and south walls. No modern heating equipment will be installed in this room.

Electrical System

Remove all electrical fixtures and wiring. No modern electrical equipment will be installed in the room.

Plumbing System

Remove the pipes that are associated with the circa-1960s hot-water baseboard heating system.

Fire-Suppression System

Install one ionization detector and one halon-type gas nozzle. The detector should be flush-mounted in the ceiling.

Finishes

Sufficient physical evidence exists to restore the finishes in Room 204 to the Stanton period, circa 1847-62, as follows:

- paint the floor with a yellow (Munsell 2.5Y 7/6) oil-based paint;
- paint the walls and ceiling with a white (Munsell 5Y 9/1) calcimine or a simulated calcimine; and
- paint the woodwork with a white (Munsell 5Y 9/1) oil-based paint.

Utility Systems

Electrical Service

Installation of 110-volt electrical service is recommended. Because the house was not wired for electricity during the historic period of 1847-62, the electrical equipment should be as unobtrusive as possible. Electricity will be needed for heating, fire- and intrusion-protection equipment, emergency lighting, and cleaning. Electrical lines from the street to the house should be buried underground so as not to detract from the historic scene. Archeological testing done in the vicinity of the utility trench in 1983 has determined that the trench will not impact archeological resources adversely.

Heating System

The Stanton House should be heated at a low but continuous temperature during the cold months of the year. This is necessary in order to safeguard against the harmful effects caused by extremes of temperature and humidity. Even if the house is not open to the public during the winter, minimal heating is necessary to prevent damage to both the interior building fabric and the proposed furnishings collection. The proposed heating system is a gas-fueled hot-water type. The water would be heated by a boiler located in the cellar. Heat would be dispersed into the rooms by fan units that could be concealed in closets or behind doorways. Energy conservation could be achieved by installing insulation in the attic floor; fiberglass is recommended.

Fire-Protection System

A fire-detection, suppression, and alarm system is recommended for the Stanton House to ensure against damage or destruction by fire. Smoke detectors should be located in the ceilings of the cellar, the first story, the second story, and the attic of both the main house and the south wing. Ionization-type detectors are recommended. A fire-suppression system would function by extinguishing a fire before it had caused significant damage or became uncontrollable. The suppression system recommended for historic building and collections is one that utilizes an inert gas such as halon. Unlike water or dry chemical powders, halon gas is efficient, relatively nontoxic, leaves no residue, and causes minimal cold shock. The gas tanks for this system should be located in the cellar, with the gas-release nozzles placed as inconspicuously as possible in all the rooms. The fire-alarm system should include both a sounding device at the house and a direct telephone dialer to the police department. The telephone line from the street to the house should be buried underground along with the electrical lines. Backup power provided by rechargeable batteries is also necessary in the event of a power failure.

Intrusion-Detection System

Protection against intruders can be provided by a perimeter-type security system. Detectors could be installed in all cellar and first-story doorways and windows, and the second-story windows accessible from porch roofs. An unobtrusive magnetic-contact type is recommended. A police alarm should be mounted on the exterior of the house, preferably on the rear elevation in an inconspicuous location. Similar to the fire-detection system, the intrusion detectors should be wired to a direct telephone dialer to the police department. The control panel for this system, run on electricity and backup batteries, could be located in a first-story closet.

VII. APPENDICES

APPENDIX A. NAIL ANALYSIS

A total of 93 nail samples were examined for this analysis. They were assigned log numbers WOR1 01 N001 through N093. This appendix consists of two tables: (1) a list of nail locations and descriptions, and (2) a summary of nail types sorted by date. Nails were differentiated by the appearance of their ends and the way in which their heads were formed. In the two tables, the following abbreviations are used:

Nail End

R = rounded

S = sheared

P = pointed

Nail Head

C = shank clasped for heading on the cut sides

F = shank clasped for heading on the flat sides

For documentation on nail technology and dating by this method, see publications listed in the bibliography by Goss, Nelson, and Priess.

Nail Sample Locations And Descriptions

Exterior Locations

- N031 Main house, north elevation, framing under board siding, at former north-wing location
Type: lath nail, machine cut
Length: 1 5/16"
End & Head: R & C
Date: circa 1839
- N042 Main house cornice, covered by south wing circa 1903
Type: cornice nail, machine cut
Length: 2 15/16"
End & Head: R, C, & F
Date: circa 1830
- N043 South wing, east elevation framing, covered by east wing
Type: siding nail?, machine cut
Length: 2 15/16"
End & Head: R & C
Date: circa 1820s
- N044 South wing, east elevation board siding
Type: siding nail, machine cut
Length: 2 7/16"
End & Head: R & F
Date: circa 1837
- N045 South wing, south elevation board siding
Type: siding nail, machine cut
Length: 2 9/16" and 3"
End & Head: R & F
Date: circa 1837
- N046 South wing, west elevation board siding
Type: siding nail, machine cut
Length: 2 1/4" and 3"
End & Head: R & F
Date: circa 1837
- N047 Main house, north elevation board siding
Type: siding nail, wire
Date: circa 1903

N048 Main house, north elevation board siding

Type: siding, machine cut
Length: 2 9/16"
End & Head: S & F
Date: circa 1864

N062 Main house, roof sheathing board

Type: sheathing, machine cut
Length: 2 1/2"
End & Head: R & C
Date: circa 1830

N072 Main house, north elevation board siding at former north-wing roof line

Type: roof flashing, machine cut
Length: 1 1/8" and 1 1/2"
End & Head: R & C
Date: circa 1839

N075 Main house attic, found loose

Type: machine cut
Length: assorted sizes
End & Head: C & F
Date: circa mid-19th century

N076 Main house roof, south side, sheathing board

Type: roof shingle, machine cut
Length: 1 1/2"
End & Head: R & C
Date: circa 1830

N077 Main house, south elevation roof plate

Type: gutter spike?, machine cut
Length: (broken off)
End & Head: R & no head (broken)
Date: circa 1830

N083 Original front doorway architrave (reused circa 1903: R193a) with siding evidence

Type: trim, machine cut
Length: (broken off)
End & Head: no point (broken); head is F
Date: circa 1837

N089 Main house south side, sheathing

Type: roof shingle (2nd shingling?), machine cut
Length:
End & Head: S & F
Date: circa 1847

Interior Locations

Cellar

N055 Main house, ceiling

Type: lath, machine cut
Length: 1 1/8" & 1 1/2"
End & Head: R & C
Date: circa 1830s

N060 Main house, ceiling at the former stairway & chimney openings

Type: lath, wire
Date: circa 1903

N084 Main house, ceiling at the former stair stringer

Type: trim, machine cut
Length: 3 3/4"
End & Head: R & C
Date: circa 1830s

N087 Main house, ceiling at former stair landing support

Type: framing, machine cut
Length: 2 1/4"
End & Head: R & F
Date: circa 1830s

Room 101

N003 West wall, behind south window architrave

Type: lath, machine cut
Length: 1 1/16" and 1 1/8"
End & Head: R & C
Date: circa 1830

N004 South wall, west side

Type: lath, machine cut
Length: 1 1/16" and 1 1/8"
End & Head: R & C
Date: circa 1830

N005 East wall, earliest nailing in left stud framing former wide doorway

Type: lath, machine cut
Length: 1 1/8"
End & Head: R & C
Date: circa 1830

End & Head: R, C, & F

N006 East wall, earliest nailing in right stud framing former wide doorway

Type: lath, machine cut
Length: 1 3/16" and 1 1/8"
End & Head: R & C
Date: circa 1830

N007 East wall, second nailing in left stud framing former wide doorway

Type: lath, machine cut
Length: 1 3/16"
End & Head: R & F
Date: circa 1840

N008 East wall, second nailing in right stud framing former wide doorway

Type: lath, machine cut
Length: 1 1/8" and 1 3/16"
End & Head: R & F
Date: circa 1840

N009 East wall, stud reused in horizontal position to frame circa-1840 wide doorway

Type: lath, machine cut
Length: 1 1/8" and 1 3/16"

Date: circa 1830 and 1840

N010 Ceiling

Type: lath, machine cut
Length: 1 1/8" and 1 1/4"
End & Head: R, C & F
Date: circa 1830 and 1840

N021 East wall, third nailing in wall studs

Type: lath, machine cut
Length: 1 1/8"
End & Head: S & F
Date: circa 1880

N022 South wall

Type: lath, machine cut
Length: 1 1/16"
End & Head: R & S, C
Date: circa 1830

N049 Window architrave, west wall south window

Type: trim, machine cut
Length: 2 7/16" and 2 9/16"
End & Head: R & F
Date: circa 1840

- N056 East wall at the northeast corner
Type: lath, machine cut
Length: 1 1/8+ "
End & Head: R & F
Date: circa 1840
- N058 East wall, behind the fireplace mantel
Type: lath, wire
Date: circa 1903
- N059 Ceiling at the former chimney opening near the north wall
Type: lath, wire
Date: circa 1903
- N061 Window architrave molding, west wall
Type: trim sprig, machine cut
Length: 2"
End & Head: R, no head
Date: circa 1840
- N073 North wall at the former doorway opening
Type: lath, machine cut
Length: 1 1/8"
End & Head: S & F
Date: circa 1880
- N086 Window frame, north wall window
Type: framing, machine cut
Length: 3 1/8" and 3 3/16"
End & Head: R & F
Date: circa 1830
- N090 Floor, outlining the former threshold to the north doorway to the missing north wing
Type: tack, machine cut
Length: (broken)
End: (broken)
Date: pre-ca. 1880
- N091 Floor
Type: tacks, machine cut
Length: 1 1/16"
End: P
Date: pre-ca. 1880

N092 Floor, at former threshold at the wide parlor doorway
Type: tacks, machine cut
Length: (broken)
End: (broken)
Date: pre-ca. 1880

Room 102

N051 Floor patch (long boards)
Type: floor, wire
Date: circa 1903

N052 Floor patch (short boards)
Type: floor, machine cut
Length: 2 1/2" and 3"
End & Head: S & F
Date: circa 1903

N067 Ceiling at former stairway opening
Type: lath, machine cut
Length: 1 1/8"
End & Head: R & F
Date: circa 1840

N085 Floor patch, at former stairway landing
Type: floor, machine cut
Length: (not available)
End & Head: R & F
Date: circa 1840

N092 Floor, at former threshold at wide parlor doorway
Type: tacks, machine cut
Length: (broken)
End: (broken)
Date: pre-ca. 1880

N093 Floor, along the perimeter of the room
Type: tacks, machine cut
Length: 5/8"
End: P
Date: pre-ca. 1880

Room 103

N011 Ceiling

Type: lath, machine cut
Length: 1"
End & Head: R & C
Date: circa 1837

N012 North wall, wood (with grained finish) reused as stud

Type: lath, machine cut
Length: 1 1/8"
End & Head: S & F
Date: circa 1880

N013 North wall

Type: lath, machine cut
Length: 1"
End & Head: R & C
Date: circa 1837

N014 Ditto N013

N015 West wall, northwest corner post

Type: lath, machine cut
Length: 1"
End & Head: R & C
Date: circa 1837

N016 North wall, west side

Type: lath, machine cut
Length: 1"
End & Head: R & C
Date: circa 1837

N017 North wall

Type: lath, machine cut
Length: 1 1/8"
End & Head: S & F
Date: circa 1880

N018 Ditto N017

N019 Ceiling beam at the south wall

Type: lath, machine cut
Length: 1"
End & Head: R & C
Date: circa 1837

N020 Ceiling near the former stairway opening

Type: lath, machine cut
Length: 1 1/8" and 1 3/16"
End & Head: R & F
Date: circa 1840

N032 North wall

Type: lath, machine cut
Length: 1 1/4"
End & Head: S & C
Date: pre-1903

N033 North wall

Type: lath, machine cut
Length: 1 1/8" and 1 1/4"
End & Head: R & C
Date: pre-1903

N050 Ceiling framing at former stairway opening

Type: trim, machine cut
Length: 2 1/2 + "
End & Head: R & F
Date: circa 1840

N057 Wall stud reused circa 1903

Type: lath, machine cut
Length: 1"
End & Head: R & C
Date: circa 1837

N068 Former north wall ceiling beam, reused under the circa-1903 front porch

Type: lath, machine cut
Length: 1"
End & Head: R & C
Date: circa 1837

N069 East wall at the window opening

Type: framing, machine cut
Length: 2 13/16"
End & Head: R & F
Date: circa 1837

N080 Floor

Type: tack, machine cut
Length: 5/8"
End: P
Date: circa 1840

Room 104

N001 West wall, behind the circa-1903 partition wall

Type: lath, machine cut
Length: 1"
End & Head: R & C
Date: circa 1837

N070 Ceiling, at the former stairway opening

Type: lath, machine cut
Length: 1"
End & Head: R & C
Date: circa 1837

N074 South wall, at the former stairway

Type: lath, machine cut
Length: 1"
End & Head: R & C
Date: circa 1837

N079 Window architrave, west wall

Type: trim, machine cut
Length: 2 7/16"
End & Head: R & F
Date: circa 1837

Second-Story Hall (Circa 1903)

N027 South wing hall, west-wall girt

Type: lath, machine cut
Length: 1 1/4"
End & Head: R & C
Date: 1837

N034 Main house, hall ceiling

Type: lath, machine cut
Length: 1 1/8"
End & Head: R & F
Date: circa 1840

N082 Wall stud reused circa 1903 (R193a)

Type: lath, machine cut (also circa-1903 wire nails)
Length: 1 3/16"
End & Head: R & F
Date: circa 1840

Room 201

N038 Ceiling, at former chimney stack

Type: lath, wire
Date: circa 1903

N039 Ceiling, at northwest corner

Type: lath, machine cut
Length: 1 1/8"
End & Head: S & C
Date: circa 1835

N040 Ceiling

Type: lath, machine cut
Length: 1 1/4"
End & Head: R & S, C
Date: circa 1835

N041 Ditto N040

N054 Window architrave, west-wall window

Type: trim, machine cut
Length: (not available)
End & Head: R & F
Date: circa 1830

N071 Window stop header, west wall window

Type: trim, machine cut
Length: 1"
End & Head: S & C
Date: circa 1830

N081 Closet door jamb (R192) reused circa 1903

Type: trim, machine cut
Length: 2 9/16"
End & Head: R & C
Date: circa 1835

Room 202

N002 South wall, behind circa-1903 chimney

Type: lath, machine cut
Length: 1 1/16+ "
End & Head: S & C
Date: circa 1835

- N023 South wall, southeast corner
Type: lath, machine cut
Length: 1 1/16" and 1 1/8"
End & Head: P & R, C
Date: circa 1835
- N035 Ceiling
Type: lath, machine cut
Length: 1 1/8+ "
End & Head: R & F
Date: circa 1840
- N036 North wall, at former window opening
Type: lath, machine cut
Length: 1"
End & Head: R & C
Date: circa 1837
- N037 North wall, adjacent to former window opening
Type: lath, machine cut
Length: 1 1/16"
End & Head: R & C
Date: circa 1835
- N053 Floor patch at former stairway opening
Type: floor, machine cut
Length: 2 1/2" and 2 9/16"
End & Head: R & F
Date: circa 1840
- N063 Baseboard, north wall
Type: trim, machine cut
Length: 3 3/16"
End & Head: R & F
Date: circa 1830
- N064 Baseboard, east wall south side
Type: trim, machine cut
Length: 2 1/2"
End & Head: R & C
Date: circa 1835
- N065 Door jamb, originally from the south doorway & reused circa 1903
Type: trim, machine cut
Length: 2 5/16"
End & Head: R & F
Date: circa 1837

N078 Ceiling at woodwork trimming former attic hatch

Type: trim, machine cut
Length: 2 3/4 +"
End & Head: R & C
Date: circa 1835

Room 203

N024 North lower wall

Type: lath, machine cut
Length: 1" and 1 1/4"
End & Head: S, R, & C
Date: circa 1837

N025 North wall post

Type: lath, machine cut
Length: 1"
End & Head: R & C
Date: circa 1837

N026 East wall girt

Type: lath
Length: 1"
End & Head: R & C
Date: circa 1837

N066 Stair railing post (R050), reused circa 1903

Type: trim, machine cut
Length: 2 1/2"
End & Head: R & F
Date: circa 1840

Room 204

N028 Framing girts, east and west walls

Type: lath, machine cut
Length: 1" and 1 3/16"
End & Head: R & C
Date: circa 1837

N029 Ceiling joists (converted to attic space circa 1903)

Type: lath, machine cut
Length: 1" and 1 3/16"
End & Head: R & C
Date: circa 1837

N088 Baseboard reused circa 1903 (R171)

Type: trim, machine cut
Length: 3 1/16"
End & Head: R & F
Date: circa 1837

Former East Wing

N030 Attic of present circa-1903 east wing, west wall

Type: lath, machine cut
Length: 1 1/4" and 1 3/16"
End & Head: R & C
Date: circa 1839

Summary of Nail Sample Types

<u>Date</u>	<u>Nail Type</u>	<u>Sample Characteristics</u>
ca. 1820s	Siding	Machine-cut nails; 2 15/16" long; rounded ends; shanks clasped for heading on the cut sides
ca. 1830	Roof Sheathing	Machine-cut nails; 2 1/2" long; rounded ends; shanks clasped for heading on the cut sides
	Roof Shingles	Machine-cut nails; 1 1/2" long; rounded ends; shanks clasped for heading on the cut sides
	Roof Cornice	Machine-cut nails; 2 15/16" long; rounded ends; shanks clasped for heading on the cut or flat sides
	Framing	Machine-cut nails; 2 1/4", 3 1/8", and 3 3/16" long; rounded ends; shanks clasped for heading on the flat sides
	Interior Trim	Machine-cut nails; 3 3/16" and 3 3/4" long; rounded ends; shanks clasped for heading on the cut or flat sides
	Interior Lath	Machine-cut nails; 1 1/16", 1 1/8", 1 3/16", and 1 1/2" long; rounded ends; shanks clasped for heading on the cut sides
ca. 1835	Interior Trim	Machine-cut nails; 2 1/2", 2 9/16", and 2 1/2" long; rounded ends, shanks clasped for heading on the cut sides
	Interior Lath	Machine-cut nails; 1 1/16", 1 1/8", and 1 1/4" long; mostly rounded ends; shanks clasped for heading on the cut sides
ca. 1837	Exterior Siding	Machine-cut nails; 2 1/4", 2 7/16", 2 9/16", and 3" long; rounded ends, shanks clasped for heading on the flat sides
	Framing	Machine-cut nails; 2 13/16" long; rounded ends; shanks clasped for heading on the flat sides
	Interior Trim	Machine-cut nails; 2 5/16", 2 7/16", and 3 1/16" long; rounded ends; shanks clasped for heading on the flat sides

	Interior Lath	Machine-cut nails; 1", 1 3/16", and 1 1/4" long; rounded and shear ends; shanks clasped for heading on the cut sides
ca. 1839	Roof Flashing	Machine-cut nails; 1 1/8" and 1 1/2" long; rounded ends; shanks clasped for heading on the cut sides
	Interior Lath	Machine-cut nails; 1 1/4", 1 3/16", and 1 5/16" long; rounded ends; shanks clasped for heading on the cut sides
ca. 1840	Interior Trim	Machine-cut nails; 2" (sprig), 2 1/2", 2 7/16", and 2 9/16" long; rounded ends; shanks clasped for heading on the flat sides
	Interior Lath	Machine-cut nails; 1 1/8" and 1 3/16" long; rounded ends; shanks clasped for heading on the flat sides
	Interior Floors	Machine-cut nails; 2 1/2" and 2 9/16" long; rounded ends; shanks clasped for heading on the flat sides
	Floor Coverings	Machine-cut tacks; 5/8" and 1 1/16" long
ca. 1847	Roof Shingles	Machine-cut nails; sheared ends; shanks clasped for heading on the flat sides
ca. 1864	Exterior Siding	Machine-cut nails; 2 9/16" long, sheared ends; shanks clasped for heading on the flat sides
	Interior Lath	Machine-cut nails; 1 1/8" long; sheared ends; shanks clasped for heading on the flat sides
ca. 1903	Exterior Siding	Wire nails
	Interior Lath	Wire nails
	Interior Floors	Wire nails; also machine-cut nails that are 2 1/2" and 3" long, with sheared ends, and shanks clasped for heading on their flat sides

APPENDIX B. MORTAR ANALYSIS

A total of 74 mortar samples were examined for this analysis. They were assigned log numbers WOR1 01 M001 through M069. This appendix consists of two tables: (1) a list of mortar sample locations, and (2) mortar/plaster analysis results.

In the table of locations, samples that were analyzed are identified by an asterisk. Other information given in this table includes the sample type (such as structural mortar or a plaster), the sand type (being a dark or light color), and the approximate date of the sample. Dates were determined based on the location of the sample and associated nails, paint, and wallpaper (if available). Mortar/plaster samples that were also analyzed as part of the paint study are cross-referenced with a paint sample number. It is interesting to note that while all circa-1903 plaster sands were observed to be a light color and pre-1903 sands a dark color, the circa-1903 structural mortar sands are all a dark color.

The analysis table gives the proportions of sand, lime, and clay (if any) of the samples examined. These results are sorted by date and by sample type. Also noted is whether or not the mortar had a hair or a fiber binder. The mortar analysis involved the following work. First, each sample was cleaned by mechanically removing obvious dirt. Wet or damp samples were dried under heat lamps. Each sample was then individually pulverized using a mortar and pestle. Twenty (20) grams of pulverized sample were weighed out, swirled in a solution of diluted hydrochloric acid (one part 38% acid to five parts water by volume), and separated into sand and fines components. After drying, the sand and fines were weighed. A computer program developed for mortar analysis by the Historic Preservation Center was used to determine percentages and parts per volume of sand, fines, and calcium hydroxide (CaOH₂).

Mortar Sample Locations

Exterior Locations

<u>Sample</u>	<u>Location</u>	<u>Type</u>	<u>Sand</u>	<u>Date</u>
M062*	Cistern, side of house	Mortar	Dark	ca. 1903
M064*	Foundation, north wall of main house (stucco)	Mortar	Dark	ca. 1837
M066*	Foundation, former north wing (archeology grid #N-1-5)	Mortar	Dark	ca. 1839
M067*	Foundation walls, former bulkhead entrance, (archeology grid #P-12)	Mortar	Dark	ca. 1837
M068*	Foundation walls, former east wing, southeast corner (archeology grid #E-5-1)	Mortar	Dark	ca. 1837
M069*	Foundation, north wall wall of main house	Mortar	Dark	ca. 1837
M070*	Foundation walls, former east wing (archeology grid #E-6-2)	Mortar	Dark	ca. 1837
M071*	Foundation wall, former east wing (archeology grid #E-6-5)	Mortar	Dark	ca. 1837
M072*	Foundation wall, former east wing (archeology grid #E-6-6)	Mortar	Dark	ca. 1837
M073*	Foundation wall, former east wing (archeology grid #E-5-6)	Mortar	Dark	ca. 1837
M074*	Foundation wall, former east wing (archeology grid #E-6-2)	Mortar	Dark	ca. 1837

M075*	Foundation wall, former east wing (archeology grid #E-6-6)	Mortar	Dark	ca. 1837
M076*	Foundation wall, former east wing (archeology grid #E-2-6)	Mortar	Dark	ca. 1820
M077*	Foundation wall, former east wing (archeology grid #E-2-5)	Mortar	Dark	ca. 1837
M078*	Foundation wall, former east wing (archeology grid #E-4-5)	Mortar	Dark	ca. 1820
M079*	Former well on the west side of the Stanton House, approx. 18" below existing grade	Mortar	Dark	ca. 1820
M080*	Foundation wall, former east wing (archeology grid #E-2-2)	Mortar	Dark	ca. 1837
M081*	Foundation wall, former east wing	Mortar	Dark	ca. 1837

Interior Locations

Cellar

M001*	Main house, ceiling	Plaster	Dark	ca. 1837
M015	Main house, ceiling, patch at heat duct	Plaster	Dark	ca. 1903
M046*	South wing, east lower wall	Mortar	Dark	ca. 1837
M047*	South wing chimney base at the south wall	Mortar	Dark	ca. 1820
M048*	Main house, north wall	Mortar	Dark	ca. 1837
M049*	Main house, ca. -1903 chimney	Mortar	Dark	ca. 1903

M057*	South wing, upper west wall (brick)	Mortar	Dark	ca. 1903
M058*	Main house floor at the north wall, brick chimney footings	Mortar	Dark	ca. 1837
M059*	South wing, upper south wall (stones)	Mortar	Dark	ca. 1903
M061*	Existing east wing bulkhead walls	Mortar	Dark	ca. 1903
M065*	Main house, patch at former doorway opening in the east wall	Mortar	Dark	ca. 1840

Room 101

M002	South wall above drop ceiling (P029)	Plaster	Light	ca. 1903
M003*	Ceiling at the wall (P030)	Plaster	Light	ca. 1903
M004	Ceiling at the east wall	Plaster	Light	ca. 1903
M005*	Ceiling at the north wall (former chimney location)	Plaster	Light	ca. 1903
M016	West wall, between the windows	Plaster	Dark	ca. 1840
M017	South wall, west side	Plaster	Dark	ca. 1840
M039*	North wall, wall cavity N-N#20 (former north wing plaster?)	Plaster	Dark	ca. 1839
M052*	West wall, beneath the south window (P247)	Plaster	Dark	ca. 1840
M053*	West wall, between the windows (P244)	Plaster	Dark	ca. 1840
M054*	East wall, north corner (P248)	Plaster	Dark	ca. 1840

M063*	Archeological plaster samples from the north side of the house	Plaster	Dark	ca. 1880
-------	--	---------	------	----------

Room 102

M006*	West wall, covered by the present stairs (P063a)	Plaster	Dark	ca. 1880
-------	--	---------	------	----------

M007	West wall, below M006 (P063b)	Plaster	Light	ca. 1903
------	-------------------------------	---------	-------	----------

M018	East wall, north corner	Plaster	Dark	ca. 1840
------	-------------------------	---------	------	----------

M019	East wall, south of M018	Plaster	Light	ca. 1903
------	--------------------------	---------	-------	----------

M020	Closet partition wall	Plaster	Light	ca. 1903
------	-----------------------	---------	-------	----------

M021	Ceiling	Plaster	Dark	ca. 1840
------	---------	---------	------	----------

M040*	East wall, wall cavity N-E #6 (P216)	Plaster	Dark	ca. 1840
-------	--------------------------------------	---------	------	----------

M043*	East and north wall cavities	Plaster	Dark	ca. 1840
-------	------------------------------	---------	------	----------

M056*	South wall, behind the ca.-1903 chimney (P261)	Plaster	Dark	ca. 1840
-------	--	---------	------	----------

M060*	Ceiling at the former stairway opening	Plaster	Dark	ca. 1840
-------	--	---------	------	----------

Room 103

M022	East wall	Plaster	Light	ca. 1903
------	-----------	---------	-------	----------

M023	South wall	Plaster	Light	ca. 1903
------	------------	---------	-------	----------

M041*	East wall cavities, S-E #2-3 (P213)	Plaster	Dark	ca. 1837
-------	-------------------------------------	---------	------	----------

M050*	West wall north side, behind baseboard	Plaster	Dark	ca. 1880
-------	--	---------	------	----------

Room 104

M024a*	West wall, behind ca.- 1903 partition	Plaster	Dark	ca. 1880
M024b*	West wall, behind ca.- 1903 partition (P210)	Plaster	Dark	ca. 1837
M025	West wall	Plaster	Light	ca. 1903

Circa-1903 Stairway and Second-Story Hall

M009	Ceiling at the stairway (P083)	Plaster	Light	ca. 1903
M010	Hall closet wall (P086)	Plaster	Light	ca. 1903
M026	Main house hall, west wall	Plaster	Light	ca. 1903
M027	South wing hall, east wall	Plaster	Light	ca. 1903
M055*	Main house hall, ceiling	Plaster	Dark	ca. 1840

Room 201

M011	North closet wall (P111)	Plaster	Dark	ca. 1835
M012	North closet wall, patch (P112)	Plaster	Light	ca. 1903
M013	Ceiling (P114)	Plaster	Dark	ca. 1835
M032	South wall	Plaster	Dark	ca. 1835
M033	West wall, below the north window	Plaster	Light	ca. 1903
M034	East wall	Plaster	Light	ca. 1903
M051*	South wall, behind the ca.-1903 partition (P224)	Plaster	Dark	ca. 1840

Room 202

M028*	South wall, behind the ca.-1903 chimney (P209)	Plaster	Dark	ca. 1840
M029	East wall, lath keys	Plaster	Dark	ca. 1835
M030	West wall, lath keys	Plaster	Light	ca. 1903
M031	South wall lath keys, to the east of the ca.-1903 chimney	Plaster	Light	ca. 1903
M045*	Ceiling (P222)	Plaster	Dark	ca. 1840

Room 203

M037	North upper wall	Plaster	Light	ca. 1903
M038	West wall	Plaster	Light	ca. 1903
M044*	North lower wall (P225)	Plaster	Dark	ca. 1837

Room 204

M0114	Closet wall, interior (P122)	Plaster	Light	ca. 1903
M035	Ceiling	Plaster	Light	ca. 1903
M036	North wall	Plaster	Light	ca. 1903
M042*	West wall cavity, Room 104 (P218)	Plaster	Dark	ca. 1837

Former East Wing

M008*	Attic of present ca.-1903 east wing, west wall	Plaster	Dark	ca. 1839
-------	--	---------	------	----------

Mortar Analysis Results

Circa-1820s Mortar

Components	Samples					
	<u>M47a</u>	<u>M47b</u>	<u>M47c</u>	<u>M076</u>	<u>M078</u>	<u>M079</u>
Sand P/V:	48	47	48	48	50	44
Lime P/V:	35	34	28	34	35	41
% Sand (Wt):	63	60	56	63	59	53
% Fines (Wt):	6	10	18	7	9	11
% CaOH ₂ (Wt):	31	31	25	30	31	36
Sand Color:	Brwn	Brwn	Brwn	Brwn	Brwn	Brwn

Circa-1837 Mortar

Components	Samples							
	<u>M046</u>	<u>M048</u>	<u>M058</u>	<u>M064</u>	<u>M067</u>	<u>M068</u>	<u>M069</u>	<u>M070</u>
Sand P/V:	54	54	54	49	57	56	54	55
Fines P/V:	24	27	24	25	25	28	23	19
% Sand (Wt):	64	62	69	72	68	63	64	68
% Fines (Wt):	15	14	9	6	9	12	15	15
% CaOH2 (Wt):	22	24	21	22	23	25	21	17
Sand Color:	Brwn	Brwn	Brwn	Brwn	Brwn	Brwn	Brwn	Brwn

	<u>M071</u>	<u>M072</u>	<u>M073</u>	<u>M074</u>	<u>M075</u>	<u>M077</u>	<u>M080</u>	<u>M081</u>
Sand P/V:	55	57	53	55	52	53	49	51
Lime P/V:	23	20	27	19	22	26	29	28
% Sand (Wt):	64	70	62	68	70	60	67	65
% Fines (Wt):	15	12	13	15	10	17	7	10
% CaOH2 (Wt):	21	18	25	17	20	23	26	25
Sand Color:	Brwn	Brwn	Brwn	Brwn	Brwn	Brwn	Brwn	Brwn

Circa-1837 Plaster

Components	Samples				
	<u>M001</u>	<u>M24b</u>	<u>M041</u>	<u>M042</u>	<u>M044</u>
Sand P/V:	40	44	48	45	47
Lime P/V:	43	37	34	34	34
% Sand (Wt):	58	61	59	63	60
% Fines (Wt):	4	6	11	5	9
% CaOH ₂ (Wt):	38	31	31	31	31
Sand Color:	Brwn	Brwn	Brwn	Brwn	Brwn

Circa-1839 Mortar

Components	Sample	
	<u>M066a</u>	<u>M066b</u>
Sand P/V:	56	56
Lime P/V:	18	17
% Sand (Wt):	63	55
% Fines (Wt):	22	30
% CaOH ₂ (Wt):	16	15
Sand Color:	Brwn	Brwn

Circa-1839 Plaster

Components	Sample	
	<u>M008</u>	<u>M039</u>
Sand P/V:	37	39
Lime P/V:	48	48
% Sand (Wt):	53	51
% Fines (Wt):	4	7
% CaOH ₂ (Wt):	42	43
Sand Color:	Brwn	Brwn

Circa-1840 Mortar

Components	Samples
	<u>M065</u>
Sand P/V:	49
Lime P/V:	25
% Sand (Wt):	67
% Fines (Wt):	11
% CaOH ₂ (Wt):	23
Sand Color:	Brwn

Circa-1840 Plaster (First Story)

Components	Samples						
	<u>M040</u>	<u>M043</u>	<u>M052</u>	<u>M053</u>	<u>M054</u>	<u>M056</u>	<u>M060</u>
Sand P/V:	43	42	45	45	44	42	44
Lime P/V:	40	39	35	38	38	37	37
% Sand (Wt):	57	61	62	57	58	59	59
% Fines (Wt):	8	4	7	9	8	8	8
% CaOH ₂ (Wt):	36	35	31	34	34	33	37
Sand Color:	Brwn	Brwn	Brwn	Brwn	Brwn	Brwn	Brwn

Circa-1840 Plaster (Second Story)

Components	Samples			
	<u>M028</u>	<u>M045</u>	<u>M051</u>	<u>M055</u>
Sand P/V:	34	36	38	36
Lime P/V:	51	51	50	51
% Sand (Wt):	49	50	49	48
% Fines (Wt):	2	4	5	6
% CaOH2 (Wt):	49	45	45	45
Sand Color:	Brwn	Brwn	Brwn	Brwn

Circa-1880 Plaster

Components	Samples			
	<u>M006</u>	<u>M24a</u>	<u>M050</u>	<u>M063</u>
Sand P/V:	49	50	48	48
Lime P/V:	28	24	28	29
% Sand (Wt):	65	72	66	67
% Fines (Wt):	10	7	8	7
% CaOH2 (Wt):	25	22	25	26
Sand Color:	Brwn	Brwn	Brwn	Brwn

Circa-1903 Mortar

Components	Samples				
	<u>M049</u>	<u>M057</u>	<u>M059</u>	<u>M061</u>	<u>M062</u>
Sand P/V:	45	45	45	47	48
Lime P/V:	33	32	33	32	33
% Sand (Wt):	63	66	63	62	61
% Fines (Wt):	7	5	7	9	10
% CaOH ₂ (Wt):	30	29	29	29	29
Sand Color:	Brwn	Brwn	Brwn	Brwn	Brwn

Circa-1903 Plaster

Components	Samples	
	<u>M003</u>	<u>M005</u>
Sand P/V:	45	40
Lime P/V:	34	40
% Sand (Wt):	62	59
% Fines (Wt):	7	5
% CaOH ₂ (Wt):	30	36
Sand Color:	White	White

APPENDIX C. PAINT ANALYSIS

A total of 445 paint samples were examined for this analysis. They were assigned log numbers WOR1 01 P001 through P444. This appendix consists of two tables: (1) a list of paint sample locations, and (2) a list of paint layers (chromo-chronologies) for both the exterior of the house and individual interior rooms.

In the first table, descriptions are given of the features from which paint samples were taken. These are features that were found in situ. Paint samples from reused woodwork and materials found in the wall cavities are listed in Appendices E and F. Dates assigned in this listing indicate the approximate time of installation of a painted feature. It was observed in a few cases that a feature remained unpainted for a period of time. Paint layers listed in the second table were identified by viewing the paint samples under magnification (up to 70x) through a Bausch and Lomb stereozoom microscope. Spot chemical tests enabled identification of lead paints (using a solution of sodium sulfide) and calcimine paints (using a diluted solution of hydrochloric acid).

For documentation on paint technology and analytical techniques, see publications listed in the bibliography by Downs, International Association of Master Painters and Decorators, Little, Masury, Moss, Sabin, and Selden.

Paint Sample Locations

Exterior Locations

Sample	Location	Substrate Date
P001	South wing west elevation, board siding under shingles	ca. 1830s
P002	South wing west elevation, doorway architrave (next to siding)	ca. 1903
P003	South wing west elevation, door	ca. 1903
P004	South wing west elevation, door jamb	ca. 1903
P005	South wing west elevation, doorway architrave (face)	ca. 1903
P006	South wing west elevation, vertical molding at door	ca. 1930s-40s
P007	South wing west elevation, horizontal molding above doorway	ca. 1903
P008	South wing west elevation, shingle siding	ca. 1930s-40s
P009	South wing west elevation, window architrave, first story	ca. 1830s
P010	South wing west elevation, window sill, first story	ca. 1830s
P011	South wing west elevation, window sash (1/1), first story	ca. 1903
P012	South wing west elevation, enclosed porch siding	ca. 1930s-40s
P013	South wing west elevation, enclosed porch doorway architrave	ca. 1930s-40s
P014	South wing west elevation, enclosed porch plasterboard siding (interior)	ca. 1930s-40s

P015	East wing east elevation, board siding	ca. 1903
P016	East wing east elevation, board siding at former partition	ca. 1903
P017	East wing east elevation, doorway architrave	ca. 1903
P018	East wing east elevation, door	ca. 1903
P019	East wing east elevation, window architrave	ca. 1903
P020	South wing east elevation, bulkhead door	ca. 1930s-40s
P021	South wing south elevation, small first-story window	ca. 1970s
P022	South wing west elevation, foundation	ca. 1830s
P023	South wing west elevation, window sill, second-story window	ca. 1903
P024	South wing west elevation, soffit edge trim	ca. 1903
P025	South wing west elevation, soffit	ca. 1903
P026	South wing west elevation, cornice	ca. 1903
P137	Main house west elevation, sill board	ca. 1903
P138	Main house, southwest corner board (no beaded detail)	ca. 1903
P139	Main house, northwest corner board (with bead)	ca. 1830s
P141	South wing west elevation, board siding	ca. 1903
P142	Main house north elevation, board siding	ca. 1903
P143	Main house west elevation, board siding	ca. 1830s
P144	Main house south elevation, board siding	ca. 1903
P230	Main house north elevation, board siding (6 1/8" wide by 7/16" thick)	ca. 1830s
P231	Main house north elevation, board siding (5 3/4" wide by 4/16" thick)	post-1863

Interior Locations

Cellar

P135 Ceiling, south wing ca. 1830s

Room 101

P027 Plasterboard, west wall ca. 1940s

P028 Plasterboard above later drop ceiling at south wall ca. 1940s

P029 Plaster above later drop ceiling, south wall
(see also M002) ca. 1903

P030 Ditto P029 (see also M003) ca. 1903

P031 Window architrave above later drop ceiling at west wall ca. 1840

P032 Window architrave, west wall ca. 1840

P033 Window architrave trim, west wall ca. 1840

P034 Window apron, west wall ca. 1840

P035 Window sash (1/1), west wall ca. 1903

P036 Baseboard at former fireplace location, north wall ca. 1903

P039 Baseboard, east wall north side ca. 1840

P040 Baseboard at former doorway location at east wall ca. 1903

P042 Ditto P036 ca. 1903

P043b Ditto P036 ca. 1903

P045 Four-panel door, south door east side ca. 1903

P046 Exterior door, south wall west side ca. 1903

P133 Doorway architrave, south wall east side ca. 1880

P154 Ditto P133 ca. 1880

P155 Window sill, north window ca. 1940s

P233	Floorboards, northwest corner (ca.-1830s closet location)	ca. 1830s
P234	Floorboards, paint outline of mantel at north wall	ca. 1830s
P244	West wall, plaster between windows (see also M053)	ca. 1840
P246	South wall west corner, plaster beneath plasterboard	ca. 1840
P247	West wall, plaster below south side window & beneath plasterboard (M052)	ca. 1840
P248	East wall north corner, plaster beneath plasterboard	ca. 1840
P257	Baseboard at north wall, formerly between the fireplace & doorway	ca. 1840
P260	Baseboard at north wall west corner	ca. 1840
P295	Left side window stop, west window (south side)	ca. 1840
P296	Right side window stop, west window (south side)	ca. 1903
P297	Window frame behind window stop, west window (south side)	ca. 1840

Room 102

P054	Doorway architrave, south wall	ca. 1903
P055	Door, south wall	ca. 1903
P056	Closet doorway architrave	ca. 1903
P058	Baseboard at later enclosure for pipes, southeast corner	ca. 1940s
P059	Baseboard, east wall south side	ca. 1903
P060	Baseboard at closet, west wall	ca. 1903
P061	Window apron & sill, east wall	ca. 1903
P063a	West plaster wall, inside closet & behind ca.-1903 stairway (M006)	ca. 1880
P063b	West plaster wall, inside closet & below ca.-1903 stairway (M007)	ca. 1903

P145	Baseboard, north wall	ca. 1840
P146	Baseboard, east wall north side	ca. 1840
P148	Baseboard, west wall north side	ca. 1840
P149	Baseboard, south wall at ca.-1903 chimney	ca. 1903
P150	Floorboards beneath ca.-1960s hardwood floor at north wall	ca. 1830s
P151	Floorboards beneath ca.-1960s hardwood floor at south wall	ca. 1830s
P219	Plaster ceiling beneath plasterboard	ca. 1840
P242	Floor patch, beneath ca.-1960s hardwood floor	ca. 1840
P243	Floor patch in ca.-1903 closet	ca. 1840
P261	Plaster under plasterboard, south wall east side	ca. 1840

Room 103

P047	Plasterboard, south wall	ca. 1940s
P048	Baseboard, south wall	ca. 1903
P049	Doorway architrave, south wall	ca. 1903
P050	Window sash (1/1), west wall	ca. 1903
P051	Exterior door, west wall	ca. 1903
P052	Four-panel door, north wall	ca. 1903
P053	Six-panel door, north wall	ca. 1903
P235	Floorboards, under ca.-1960s floor, near ca.-1903 south wall	ca. 1830s
P236	Floorboards, under ca.-1960s floor, at northeast corner	ca. 1830s
P237	Floorboards, under ca.-1960s floor, at northwest corner	ca. 1830s

P249	Floorboards, under ca.-1960s floor, adjacent to former stairway	ca. 1830s
P250	Ditto P249, at red-painted border	ca. 1830s
P251	Floorboards, under ca.-1960s floor, beneath former stairway	ca. 1830s
P252	Floorboards, under ca.-1960s floor, at painted outline of doorway architrave molding	ca. 1830s
P289	Door jamb Room-103 side, north wall west side	ca. 1880

Room 104

P064	Plasterboard, west wall	ca. 1940s
P065	Window apron & sill, west wall	ca. 1830s
P066	Window sash (1/1), west wall	ca. 1903
P067	Window architrave, west wall	ca. 1830s
P069	Baseboard, north wall	ca. 1903
P070	Plasterboard partition, east wall	ca. 1970s
P162	Baseboard, south wall	ca. 1903
P163	Window sill, south wall	ca. 1903
P210	West plaster wall behind ca.-1903 partition wall (M024)	ca. 1830s
P238	Floorboards, southwest corner at former closet	ca. 1830s
P239	Floorboards, southwest corner at former closet partition	ca. 1830s
P240	Floorboards, southwest corner outside former closet	ca. 1830s
P241	Floorboards at mid room	ca. 1830s
P293	Window stop, left side, west wall	ca. 1830s
P294	Window frame behind stop, west wall	ca. 1830s

Room 105

P071	Plasterboard, west wall	ca. 1940s
P072	Doorway architrave, west wall	ca. 1903
P073b	Wainscot, west wall	ca. 1903
P074	Window apron & sill, south wall	ca. 1903
P075	Window sash, south wall	ca. 1970s
P076	Window apron, sill, & architrave north wall	ca. 1940s
P077a	Cabinet frame, west wall	ca. 1903
P077b	Cabinet doors & drawers, west wall	ca. 1970s
P078	Window architrave, east wall	ca. 1903
P079	Doorway architrave, east wall	ca. 1903
P080	Door, east wall	ca. 1903

Circa-1903 Stairway and Second-Story Hall

P081	Stairway: risers & treads	ca. 1903
P082	Stairway: wood bead at stair opening in second floor	ca. 1903
P083	Stairway ceiling, plaster (M009)	ca. 1903
P086	Hall closet: plaster wall (M010)	ca. 1903
P089	Hall floor: at railing balusters	ca. 1903
P090	Hall floorboards, main house	ca. 1830s
P091	Hall floorboards	ca. 1830s
P092	Hall: wood corner bead at wall	ca. 1940s
P093	Hall floorboards	ca. 1830s
P167	Hall baseboard, west wall in main house (covered by paneling)	ca. 1903

P168	Hall baseboard, east wall in main house (covered by paneling)	ca. 1903
P170	Hall doorway architrave, east wall in main house (covered by paneling)	ca. 1903
P175	Hall baseboard, east wall in south wing (covered by paneling)	ca. 1903
P176	Hall doorway architrave, south wall in south wing (covered by paneling)	ca. 1903
P177	Hall doorway architrave, east wall in south wing (covered by paneling)	ca. 1903
P227	Hall ceiling in main house at north wall	ca. 1840
P254	Hall floorboards at former closet partition wall, main house north wall	ca. 1830s

Room 201

P104	Floor patch at former hearth	ca. 1903
P105	Floorboards in present closet at north wall	ca. 1830s
P106	Floorboards, south wall	ca. 1830s
P107	Window apron & sill, west wall	ca. 1830s
P108	Window sash (1/1), west wall	ca. 1903
P109a	Baseboard, west wall	ca. 1830s
P109b	Door stop, north wall	ca. 1903
P111	North plaster wall, northeast corner (under paneling)	ca. 1840
P112	Plaster patch, north wall (under paneling)	ca. 1903
P114	Plaster ceiling	ca. 1840
P185	Baseboard, west wall	ca. 1830s
P186	Baseboard at ca.-1903 partition wall	ca. 1903

P187	Baseboard, south wall	ca. 1830s
P188	North plaster wall at closet (under paneling)	ca. 1903
P189	West plaster wall (under paneling)	ca. 1840
P190	South plaster wall (under paneling)	ca. 1840
P191	Patch at south plaster wall	ca. 1903
P223	North plaster wall, behind later hall partition wall	ca. 1840
P224	South plaster wall, behind later hall partition wall	ca. 1840
P262	Window architrave, west wall	ca. 1830s
P290	Right window stop at west wall south side window	ca. 1840
P291	Window lintel of west wall south side window	ca. 1830s
P292	Window frame behind stop, west wall south side window	ca. 1830s

Room 202

P094	Window sill & apron, east wall window	ca. 1940s
P095	Window sash, east wall window	ca. 1940s
P096	Baseboard, east wall	ca. 1830s
P097	Baseboard, west wall	ca. 1903
P098	Plasterboard, west wall	ca. 1940s
P099	Doorway architrave, west wall	ca. 1940s
P101	Closet door, north wall	ca. 1940s
P102	Floorboards	ca. 1830s
P103	Floorboard patch at former stairway	ca. 1840
P180	Baseboard, north closet partition	ca. 1940s
P181	Baseboard at enclosure for ca.-1903 chimney	ca. 1940s
P182	Baseboard (top strip of wood) at north wall	ca. 1903

P183	Baseboard, south wall	ca. 1830
P209	South plaster wall behind ca.-1903 chimney (M028)	ca. 1840
P221	North plaster wall behind ca.-1903 hall partition wall	ca. 1840
P222	Plaster ceiling (M045)	ca. 1840
P281	Baseboard, east wall south side (to right of former partition wall)	ca. 1830s
P282	Baseboard, east wall south side (at shadow of former partition wall)	ca. 1840

Room 203

P128	Window apron & trim, east wall window	ca. 1940s
P130	Doorway architrave, west wall	ca. 1940s
P131	Plasterboard, west wall	ca. 1940s
P204	North wall plaster under plasterboard	ca. 1903
P205	South wall plaster under plasterboard	ca. 1903
P206	West wall plaster under plasterboard	ca. 1903
P207	Wainscot at north wall (covered by later tile board)	ca. 1903
P208	Floorboards, next to bathtub	ca. 1903
P225	North plaster wall (covered by wainscot) - M044	ca. 1830s

Room 204

P115	Floorboards, beneath newspapers dated "1934"	ca. 1830s
P116	Floorboards at the room perimeter	ca. 1830s
P117	Floorboards in the ca.-1903 closet	ca. 1830s
P118	Doorway architrave, north closet doorway	ca. 1903
P122	Plaster walls, closet interior	ca. 1903

P123b	Window architrave, south window	ca. 1903
P124	Window sash (1/1) south window	ca. 1903
P127	Baseboard, east wall	ca. 1903
P192	North plaster wall under ca.-1970s wallpaper	ca. 1903
P193	Baseboard, north wall	ca. 1903
P194	Window architrave, south window west side	ca. 1903
P196	Doorway architrave, north wall hall doorway	ca. 1903

Paint Samples from Wall Cavities: see Appendix E

Paint Samples from Reused Woodwork: see Appendix F

Paint Sample Layers

In the following charts, an asterisk (*) denotes lead paint, while a plus sign (+) denotes calcimine paint.

Exterior Samples

Date	Siding	Cornice	Door/Window Trim		Window Sash
ca. 1830	yellow*	white*			
ca. 1837	white*	white*	white*		
ca. 1847	ditto	ditto	ditto		
ca. 1864	red	red	red		
?			red		
ca. 1903	white	white	white	white	
?		white*	white*	white*	
?		white*	white*	white*	white
ca. 1915	gray	off-white	off-white	gray*	
1928		gray	white*	gray	black
ca. 1930s	(shingles)				
ca. 1948	green	white*	white*	white	
?		white*	cream	white*	white*
ca. 1970s	green	white	white	white	

Interior Samples

Room 101

<u>Date</u>	<u>Walls</u>	<u>Ceiling</u>	<u>Woodwork</u>	<u>Floor</u>
ca. 1830			lt. gray*	gray*
			cream*	red
ca. 1840			pink* varnish	
ca. 1847	(wallpaper)		yellow varnish	
ca. 1850s	(wallpaper)			
ca. 1880	(wallpaper)		white varnish	
ca. 1903	(wallpaper)		white	
?	(wallpaper)		white*	
?	(wallpaper)		white white	
?	(wallpaper)		yellow	
ca. 1948	(plasterboard) white		yellow	
ca. 1960s	pink		white	(oak)
ca. 1970s	yellow	(drop ceiling)	white	

Room 102

<u>Date</u>	<u>Walls</u>	<u>Ceiling</u>	<u>Woodwork</u>	<u>Floor</u>
ca. 1830				
ca. 1840	(wallpaper)	white + (multiple layers)	pink* varnish	
ca. 1847	(wallpaper)		yellow varnish	
ca. 1850s	(wallpaper)			
ca. 1880	(wallpaper)		gray	
ca. 1903	(wallpaper)	(paper)	white*	gray
?			white*	gray
?			white	
?			white*	
?			white*	
ca. 1948	(wallpaper)	(paper)	white	
ca. 1960s	(wallpaper)		white	(oak)
ca. 1970s	(paneling)	(tiles)		

Room 103

<u>Date</u>	<u>Walls</u>	<u>Ceiling</u>	<u>Woodwork</u>	<u>Floor</u>
ca. 1830s	white +		cream*	gray*
?	white +		cream*	red*
ca. 1840	(wallpaper)		pink varnish	
ca. 1847	(wallpaper)		white*	
ca. 1850s	(wallpaper)			
?	(wallpaper)		white*	
ca. 1880	(wallpaper)		white varnish	gray*
ca. 1903	(wallpaper)	(paper)	pink	gray
?		(paper)	pink*	
?		(paper)	cream*	
?			yellow*	
?			yellow*	
?			yellow	
?			cream*	
?			cream*	
ca. 1948	(plasterboard) green	(plasterboard)	cream*	
ca. 1960s	pink		white	(oak)

Room 104

<u>Date</u>	<u>Walls</u>	<u>Ceiling</u>	<u>Woodwork</u>	<u>Floor</u>
ca. 1830s	blue +	white + (multiple layers)	gray*	
?	white +			
?	white +			yellow*
?	white +			
?	(wallpaper)		cream* pink varnish	
?	blue*			
ca. 1840	(wallpaper)		white* pink* varnish	
ca. 1847	(wallpaper)		cream varnish	
ca. 1850s	(wallpaper)			
ca. 1880	(wallpaper)		gray	gray*
?	(wallpaper)		gray	
ca. 1903	(wallpaper)	paper	green	pink-red
?	(wallpaper)	paper	green	yellow
?	(wallpaper)	paper	white*	
?	(wallpaper)	paper	cream*	
?			cream*	
?			cream*	
?			cream	
ca. 1948	(plasterboard) pink	(plasterboard)	white	
ca. 1960s	blue		white	(oak)

Circa-1903 Stairway and Hall

<u>Date</u>	<u>Walls</u>	<u>Ceiling</u>	<u>Woodwork</u>	<u>Floor</u>
ca. 1840				yellow*
ca. 1903	(wallpaper)	(paper)	lt. pink	mustard
?			crm-yellow	red varnish
?			crm-yellow	
?			crm-yellow	red
?			crm-yellow	brown
ca. 1960s	(paneling)		crm-yellow	dk gray

Room 201

<u>Date</u>	<u>Walls</u>	<u>Ceiling</u>	<u>Woodwork</u>	<u>Floor</u>
ca. 1830s			lt. gray*	
"			dk. gray*	
ca. 1840	yellow +		cream*	yellow*
?	green +			
?	white +			
ca. 1847	(wallpaper)		white*	
ca. 1880	(wallpaper)		white	
ca. 1903	pink		pink	mustard
?			lt. yellow	yellow
?			lt. yellow	pk-red
ca. 1970s	(paneling)	(plaster skim)	white	

Room 202

<u>Date</u>	<u>Walls</u>	<u>Ceiling</u>	<u>Woodwork</u>	<u>Floor</u>
ca. 1830s			lt. gray*	
"			dk. gray*	
ca. 1840	yellow +	white + (multiple layers)	cream* varnish	yellow*
?	green +			
ca. 1847	(wallpaper)		white*	
ca. 1880	(wallpaper)		white	
ca. 1903	(wallpaper)	(paper)	white	mustard
?			green	pink varnish
?			cream*	red
ca. 1948	(plasterboard) white	(plasterboard) cream		brown
?	pink		white*	red
?	green		white	

Room 203

<u>Date</u>	<u>Walls</u>	<u>Ceiling</u>	<u>Woodwork</u>	<u>Floor</u>
ca. 1830s	white +			
"	white +			
"	white +			
ca. 1840	(wallpaper)		white*	
ca. 1847	(wallpaper)		white*	
ca. 1880	(wallpaper)		white	
ca. 1903	lt. yellow		varnish	gray (4x)
?	white			yellow yellow
?	cream			brown-red
?	cream			red
ca. 1948	(plasterboard)	(plasterboard)		
?	white		white	brown-grn
?	yellow		yellow	lt. gray

Room 204

<u>Date</u>	<u>Walls</u>	<u>Ceiling</u>	<u>Woodwork</u>	<u>Floor</u>
ca. 1830s	white + (multiple layers)		dk. gray*	
ca. 1840			white*	yellow*
ca. 1847			white*	
ca. 1880	lt. blue +		white	
ca. 1903			lt. pink	mustard
?			cream	pink
?			yellow	pink
ca. 1940s			cream	brown
ca. 1970s	(wallpaper)			

APPENDIX D. WALLPAPER ANALYSIS

A total of 41 wallpaper samples were examined for this analysis. They were assigned log numbers WOR1 01 W001 through W041. This appendix consists of two tables: (1) a list of wallpaper sample locations, and (2) a listing of wallpaper layers found in each room of the Stanton House. Wallpapers from the Stanton period (1847-1962) are noted by an asterisk (*). For a discussion of wallpaper dating techniques used at the Stanton House, see chapter III of this report, "Physical Investigation and Analysis: Architecture."

Information on wallpaper styles and technology was obtained from various sources. These are listed in the bibliography under the following authors: Bishop, Lynn, Nylander, and Plenderleith.

Wallpaper Sample Locations

<u>Sample</u>	<u>Location</u>	<u>Plaster Date</u>
Room 101		
W001	East partition wall, wall cavity	Loose sample
W002	Greek Revival mantel, back side	Wood, ca. 1840
W003	North wall, wall cavity N-N #11	Loose sample
W004	Walls, behind ca.-1940s plasterboard	Ca. 1840 & 1903
Room 102		
W005	South wall, behind ca.-1903 chimney	Ca. 1840
W006	West wall, behind ca.-1903 stairs	Ca. 1880
W007	North wall, wall cavity N-N #4	Loose sample
W008	North wall, wall cavity N-N #4-5	Loose sample
W009	East wall, wall cavity N-E #1	Loose sample
W010	East wall, wall cavity N-E #4	Loose sample
W011	East wall, wall cavity N-E #10	Loose sample
W012	East wall, wall cavity N-E #11	Loose sample
W013	East wall, wall cavity N-E #12	Loose sample
W014	Reused wood trim, R038	Wood, ca. 1840
W015	Walls, behind ca.-1960s paneling and ca.-1940 plasterboard	Ca. 1840 & 1903
W016	Ceiling, behind ca.-1960s tiles	Ca. 1840 & 1903
Room 103		
W017	Discarded under ca.-1903 front porch	Ca. 1837
W018	East wall, wall cavity S-E #3-4	Loose sample
W019	West wall, behind ca.-1903 baseboard	Ca. 1880
W020	Ceiling, behind ca.-1940s plasterboard	Ca. 1903
Room 104		
W021	South wall, wall cavity S-S #1-2	Loose sample
W022	Walls, behind ca.-1940s plasterboard	Ca. 1903
W023	Ceiling, behind ca.-1940s plasterboard	Ca. 1903
W024	West wall, behind ca.-1903 partition	Ca. 1837
W025	West wall, behind ca.-1903 partition (patch)	Ca. 1880
W026	Discarded under ca.-1903 front porch	Ca. 1837

Stairway and Hall (ca. 1903)

W027	Stair hall, ca. 1903	Ca. 1903
W028	Ceiling, second-story hall, main house and south wing	Ca. 1840 & 1903

Room 201

W029	North wall, behind ca.-1903 partition	Ca. 1840
W030	South wall, behind ca.-1903 partition	Ca. 1840

Room 202

W031	South wall, behind ca.-1903 chimney	Ca. 1840
W032	North wall, behind ca.-1903 partition	Ca. 1840
W033	Doorway architrave reused ca. 1903	Wood, ca. 1840
W034	Ceiling, behind ca.-1940s plasterboard	Ca. 1840
W035	Discarded under ca.-1903 front porch	Loose sample

Room 203

W036	North wall, behind ca.-1940s tileboard and ca.-1903 wainscot	Ca. 1837
W037	Discarded under ca.-1903 front porch	Ca. 1837
W038	Discarded under ca.-1903 front porch	Ca. 1837

Room 204

W039	Walls	Ca. 1903
------	-------	----------

Unknown

W040	Board reused as stud ca. 1903	Unknown date
W041	Underside of ca.-1903 floor patch in Room 102	Unknown date

Wallpaper Sample Layers

Room 101

Layer	Wallpaper Description	Date
	--Circa-1840 plaster--	
Early	Unidentifiable paper fragments	Unknown
1.	Floral body paper (green, orange, white) with floral border (blue, red)	Ca. 1880s
2.	Floral body paper (green, cream) with floral border (green, mustard)	Ca. 1890s
	--Circa-1903 plaster--	
3.	Gold foliate design (white, gold)	Ca. 1903
4.	Stripe (white, green)	Post-1903
5.	Floral (pink, white)	Post-1903
6.	Embossed (beige, white)	Post-1903
	--Circa-1940s painted plasterboard--	Ca. 1940s

Room 102

Layer	Wallpaper Description	Date
	--Circa-1840 plaster--	
1.	Foliate (black, green, yellow)	Ca. 1840
2.*	Stripe (white, green)	Ca. 1847
3.*	Floral & scrollwork (white, gray)	Ca. 1850s
4.	Floral, stripe, & paisley (white, gray, green)	Ca. 1870s
5.	Foliate wreaths (orange, white)	Ca. 1870s

6.	Wood graining (red, beige)	Ca. 1870s
7.	Floral & diaper [diamond] (white, blue, mustard, green)	Ca. 1880s
8.	Foliate (green, white)	Ca. 1880s
9.	Foliate (mustard)	Ca. 1890s
	--Circa-1903 plaster--	
10.	Wall: floral design (pink, yellow, green, mustard) Ceiling: swirl design (white)	Ca. 1903 Ca. 1903
11.	Wall: speckled design (green, white, gold) Ceiling: "threads" design (silver, white)	Ca. 1940s

Room 103

Layer	Wallpaper Description	Date
	--Circa-1837 plaster--	
	Paint (white calcimine)	Ca. 1837
1.	Neoclassical with border (blue, white, black; border also has green)	Ca. 1840
2.*	Floral (pink, cream)	Ca. 1847
3.*	Foliate with border (gray, white, green; flocked border)	Ca. 1850s
4.	Shamrocks with border (brown, white; border is purple, green)	Ca. 1860s
5.	Geometric with border (blue, beige; border is green, yellow)	Ca. 1870s
6.	Floral & geometric with border (red, beige, white)	Ca. 1880s
7.	Chinese scenic with border (yellow, green black; pink floral border)	Ca. 1880s
8.	Floral with border (pink, green; border is gold & yellow)	Ca. 1890s

- | | | |
|-----|---|-----------|
| 9. | New floral border applied over old
(dark green and pink)

--Circa-1903 ceiling plaster on old lath-- | Ca. 1890s |
| 10. | Ceiling: dots (silver) | Ca. 1903 |
| 11. | Ceiling: swirls (silver, cream) | Ca. 1920s |
| 12. | Ceiling: abstract (silver, gray)

--Circa-1940s painted plasterboard-- | Ca. 1930s |

Room 104

Layer	Wallpaper Description	Date
	--Circa-1837 plaster--	
	Paint (calcimine)	Ca. 1837
1.	Grape leaves (black, mustard)	Post-1837
	Paint (mustard yellow)	Post-1837
2.	Marble design & dots (blue, red)	Post-1837
3.*	Diaper [diamond] pattern (red, green, gold)	Ca. 1847
4.*	Stripe (blue, green, white)	Ca. 1850s
5.	Foliate (dark green, white)	Ca. 1860s
6.	Floral (blue, red, white)	Ca. 1870s
7.	Stripe (blue, white, orange, black)	Ca. 1870s
8.	Stripe & foliate (blue, white)	Post-1870s
9.	Floral with border (white; border is yellow, red)	Post-1870s
10.	Floral with border (blue, green; border is yellow, green, black)	Post-1870s
11.	Floral with border (red, yellow, white; border is red, yellow, green)	Post-1870s

12.	Floral with border (blue, green)	Post-1870s
13.	Floral with border; body paper made by Birge & Sons (pink, green; border is yellow, red) --Circa-1903 plaster--	Post-1870s
14.	Ceiling: lines & dots (white)	Ca. 1903
15.	Wall: indistinguishable pattern (gray, white) Ceiling: ditto (gray, white)	Post-1903
16.	Wall: embossed (beige, green, red) Ceiling: marble (silver, cream)	Post-1903
17.	Wall: embossed (beige, green, red) Ceiling: abstract (silver, gray) --Circa-1940s plasterboard--	Post-1903

Room 201

Layer	Wallpaper Description	Date
	--Circa-1840 plaster-- Paint (calcimine)	
1.	Wallpaper fragments only, "shamrock" pattern (green, white, brown)	Ca. 1860s?
2.	Floral with border (yellow, white; border is yellow, red)	Post-1860s

Room 202

Layer	Wallpaper Description	Date
	--Circa-1840 plaster-- Paint (calcimine)	
1.	Geometric (red, brown, white)	Early 1840s
2.*	Foliate (green, red, gray)	Ca. 1847

3.*	Geometric diaper [diamond] with flocked border (beige, white, red; green flock)	Ca. 1850s
4.	“Shamrock” pattern (green, white, brown)	Ca. 1860s
5.	Floral with border (blue, white)	Ca. 1870s
6.	Foliate with border (green, red, yellow)	Ca. 1880s
	--Circa-1903 plaster--	
7.	Ceiling: abstract (silver pattern) Wall: none remaining	Ca. 1903
	--Circa-1940s plasterboard--	

Room 203

Layer	Wallpaper Description	Date
	--Circa-1840 plaster--	
	--Circa-1837 plaster--	
	Paint (Calcimine)	
1.	Neoclassical with border (blue, white, black; border also has green)	Ca. 1840
2.*	Floral (pink, cream)	Ca. 1847
3.*	Foliate with border (gray, white, green; flocked border)	Ca. 1850s
4.	“Shamrock” pattern with border (brown, white; border is purple, green)	Ca. 1860s
5.	Geometric with border (blue, beige; border is green, yellow)	Ca. 1870s
6.	Chinese scenic with border (yellow, green black; border is pink floral)	Ca. 1880s
	--Circa-1903 plaster & bathroom wainscot--	

Room 204

Layer	Wallpaper Description	Date
	--Circa-1903 plaster--	
1.	Floral (pink roses)	Ca. 1970s

Stairway and Hall

	--Circa-1903 plaster--	
1.	Wall: geometric (green, black, white) Ceiling: ditto	Ca. 1903
2.	Wall: floral (multi-color) Ceiling: dots (silver, cream)	Post-1903

APPENDIX E. CONTENTS OF WALL CAVITIES

Wall cavities are defined to be the space enclosed by exterior siding and interior plaster walls that are segmented by framing studs and braces. A considerable amount of debris was found in the wall cavities at the Stanton House during the removal and restoration of the exterior siding. While this debris consisted primarily of broken plaster keys, other materials of architectural interest were also found such as wallpaper fragments, loose nails, and painted plaster fragments. In order to systematically sort through and retrieve significant artifacts, the wall cavities were numbered and their contents emptied into plastic garbage bags. The bags were later emptied and carefully sorted. An example of a wall cavity number in the south wing is "S-S #2." In this system, the first "S" signifies the south wing, the second "S" the south elevation, and the "#2" wall cavity number two. A wall cavity in the main part of the house would have a number such as "N-E #1" where the first "N" signifies the main part of the house that is on the north side of the south wing. A listing of all the wall cavities that were examined follows:

First Story

Main house, west elevation: Cavities N-W #1-13 (numbered north to south)

Main house, north elevation: Cavities N-N #1-24 (numbered east to west)

Main house, east elevation: Cavities N-E #1-16 (numbered south to north)

Main house, south elevation: Not numbered

South wing, west elevation: Cavities S-W #1-7 (numbered south to north)

South wing, south elevation: Cavities S-S #1-11 (numbered west to east)

South wing, east elevation: Cavities S-E #1-4 (numbered south to north)

Second Story

Main house, east elevation: Cavities N-E 2nd, #8-15 (numbered south to north)

A listing of significant artifacts found in the wall cavities, sorted by contiguous interior rooms, is presented here. In the case of second floor rooms, painted wall plaster was often found to have fallen into the first floor wall cavities and this is noted accordingly. Samples of architectural materials that were retrieved are indicated by the notations "M00X" for mortar/plaster, "P00X" for paint, and "W00X" for wallpaper.

Room 101

West Wall

- Cavities N-W #1-4:
- brick fragments

North Wall

- Cavity N-N #11:
- wallpaper (W003)

- Cavity N-N #16:
- painted plaster finished with three layers of white calcimine paint (P214) and wallpaper fibers; may be a ceiling sample

- Cavities N-N #19 and #20:
- brick fragments

South Wall

- Cavity adjacent to circa-1903 exterior doorway:
- metal button, about 3/4" diameter, imprinted on back with "REAL TREBLE GILT"

Room 102

North Wall

- Cavity N-N #2:
- glass (window?) fragment

- Cavity N-N #4:
- coal
- wallpaper (W007)

- Cavity N-N #5:
- brick fragments

- Cavities N-N #4 and #5:
- Room-102 wallpaper, eight layers, circa 1840-circa 1880s (W008)

East Wall

Cavity N-E #1:

- wallpaper (W009)

Cavity N-E #4:

- wallpaper (W010)

Cavity N-E #6

- old glass fragment (bubbled)
- brick fragment

Cavity N-E #7

- brick fragment

Cavity N-E #9

- plaster with circa-1840 grained finish, similar to extant panel under window in Room 101 (P217)

Cavity N-E #10

- Room-102 wallpaper, six layers, circa 1840-circa 1870s (W011)

Cavity N-E #11:

- Room-102 wallpaper, layer #8, circa 1880 (W012)
- coal
- small hexagonal black glass bead (as from a woman's dress)

Cavity N-E #12:

- Room-102 wallpaper (W013)
- brick fragment
- glass buttons (two each)
- coal
- straight (common) pin

Cavities N-E #5, 6, 10, and 12:

- Room-102 wallpaper layer #9
- plaster painted with six layers of white calcimine paint (P216); most likely from the ceiling

Cavity N-E #?:

- Indian Head penny dated 1859. A conservation report about this penny was prepared by Edward McManus in November 1982 and is on file at the park

Room 103

East Wall

Cavities S-E #2 and #3:

- Room-103 wallpaper, layer #1, ca. 1840 (W018)
- plaster sample, circa 1837 (M041)
- painted plaster samples, ca. 1837 (P211 & P213)
- painted wood sample, circa 1840 (P212)

Cavities W-E #3 and #4:

- wallpaper (W018)

Cavity S-E #?:

- doorway threshold in situ, pre-ca. 1837

Room 104

South Wall

Cavities S-S #1 and #2:

- Room-104 ca. 1880s-90s ceiling paper (W021)
- hair pins (two each)
- paper wasp's nest

Cavity S-S #9:

- 20th-century debris associated with 1972 toilet-room addition

West Wall

Cavity S-W #1:

- straight (common) pin

Cavity S-W #4:

- straight (common) pins
- glass fragment

Cavity S-W #5:

- straight pins

Cavity S-W #6:

- Room-104 wallpaper fragments, pre- and post-1903 (not cataloged)
- perlite insulation

Cavity S-W #7:

- window glass fragments
- Room-104 wallpaper fragments, pre-1903 (not cataloged)
- perlite insulation

Room 202

East Wall

Cavities N-E #2, 8, 9, and 10 (first story):

- plaster with painted (P215)

Cavity N-E 2nd, #8:

- painted plaster
- Room-202 wallpaper fragments (not cataloged)
- glass fragment
- lead-glazed earthenware fragment

Cavities N-E 2nd, #9, 10, and 11:

- painted plaster
- Room-202 wallpaper fragments (not cataloged)
- mud and paper wasp's nests

Room 204

West Wall

Cavity S-W at south corner (first story):

- plaster with light-blue calcimine finish (P218)

Cavities S-W #3 and 5 (first story):

- painted ca.-1903 plaster

APPENDIX F. REUSED WOODWORK

This appendix consists of a complete list of historic woodwork pieces (and some hardware) that were reused using the various remodelings of the Stanton House. A total of 195 items were collected and analyzed. They were assigned log numbers WOR1 01 R001 through R195, with numbers being arbitrarily assigned to items in the order in which they were found. The log numbers were written in indelible ink directly on each object. The collection is now in storage in the cellar of the Stanton House.

R001	Rm 204, CL INT BSBIRD, N WALL, "3' 7 3/8"	2' 10 3/4" L x 6 1/2" H x 1" THICK	P264 P132	RMS 103/203 (STAIRS)
R002	Rm 204, CL INT BSBIRD, N WALL, "2' 7 3/8"	4' 5" L x 6 1/4" H x 1" THICK	P265	RM 203?
R003	Rm 204, CL INT BSBIRD, W WALL, "1' 8 1/8"	2' 11" Long x 6 1/4" H x 1" THICK (RT SIDE, 1 1/2" GREY PAINT)	P266	RM 104
R004	Rm 204, CL INT BSBIRD, S WALL, "1' 8 1/8"	8' 3/8" L x 6 1/4" H x 1" THICK	P267 P121	RM 104
R005	DOOR CL CURVED ARCH W/ SKRIMP MOLDING GONE, SPALLS IMPACT - 3 1/2" W x 2' 10 1/2" L		P268	RM 104
R006	Rm 202 - BEARD E WALL, N SIDE		P268 (a) P268 (b)	RMS 103/203 (STAIRS)
R007	Rm 104 BEARD - W WALL, "1' 7 3/8"		P269 (a) P269 (b)	RM 104 (W WALL)
R008	Rm 104 BEARD - W WALL, "2' 7 3/8"	7' L, 6 1/2 - 3/4" H, 1" THICK	P270 P161	RM 104
R009	Rm 202 - BEARD E WALL, N SIDE		P271	RMS 103/203 (STAIRS)
R010	2ND FLOOR 1900 CL BEARD, E WALL	11-8 1/2" L x 6 3/8" H x 1" THICK - BOTTOM CIR. SAW MARKS, KILL PAINT @ TOP (GRN + YEL)	P272 P087	RMS 201/202
R011 (6/18/0)	Rm 203 9/6 SASH E WALL, INT SASH STOP - SIDE	3' 6 3/4" L x 6 1/4" W x 1/2" (-) THICK - bead on one edge	P273 (a)	RM 7 6/18/00
R012 (6/18/0)	Rm 203 9/6 SASH E WALL, INT SASH STOP - LINEAL	2' 3 1/2" L x 5 1/4" W x 1/2" (-) THICK - beads on both edges	P273 (b)	RM 7 6/18/00
R013	Rm 203 9/6 SASH E WALL - upper 6/18/00		P263 (EXT) P129	RM 204? SO. WALL?

WORI 01 REUSED PAINTED WOODWORK

CATALOG NUMBER	REUSE LOCATION	WOODWORK DESCRIPTION	NAIL TYPE(S)	PAINT SAMPLE(S)	ORIGINAL LOCATION
R014	RM 203. E WALL WINDOW 1/6 SASH	WINDOW FRAME	CUT-R. FLAT	P277	RM 204 (S wall)
R015	RM 103/4 "fill-up studs for central post repair" (2 pieces)	<p>2' 0" LEVEL (TOP) 3 3/8" LEVEL 1/2" THICK NO PAINT</p>		P274	RM 104
R016	DITO R015?	<p>9 3/4" x 12 7/8" x 15 1/2" BEAD MIN. 3/4" x 3/4" W 3 STRUCK NAILS 1 1/2" THICK SIMILAR TO R016, BUT NO NAILS - THE PAINT W/ P/EN AND HAD TO BE REMOVED</p>		P275	RM 201/202 (N wall closet)
R017	DITO R015?	<p>4" x 4" x 1 1/2" KIM PAINT SPRINGS - 2x PAINT - 2x 6 1/2" NO PAINT</p>		P278	RM 201/2
R018	RM 101, N wall - on window arch. Have 4 molding - installed when chimney removed ca. 1900 + bead.	<p>6 1/4" x 2 1/2" x 2" BEAD W/ BEVEL NO PAINT - BEAD NO PAINT - BEAD GRAY PAINT - BEAD ORIG. MOLDING INSTALLED CA 1900 Edge: wallpaper fragments RM 104.</p>		P279 P274	RM 101 S wall
R019	RM 104 E wall doorway to kitchen - left side architrave	<p>4 3/8" x 2 1/2" x 2" BEAD W/ BEVEL NO PAINT - BEAD NO PAINT - BEAD X-SECTION</p>		P276 (a) P068 (RT SIDE)	RM 104
R020	A. OFF-2- MOLDING ATTACHED TO R019A RT SIDE B. ditto, attached to R019 (B) - TOP - 3 1/4 1/2" L x 1 1/8" W C. ditto, attached to ca. R00 board - RT SIDE - 1 7/8" W	<p>6' 11 3/4" x 5' 3 3/4" L x 3 1/8" W RIM 104 WALLPAPER (see 173) - 4 1/2" THICK EDGE NOTE - RM 104, W WALL WINDOW = 4' 10 1/2" L - 1 7/8" W PAINT LINE - EARLY PAINT - BEAD</p>	SPRINGS & WIRE	(a) P276 (b) (b) P299 (c) P300	RM 104
R021	OFF-2- MOLDINGS - RM 104, S WALL WINDOW (#1=L SIDE, #2=R SIDE)	<p>2' 11 1/4" x 2 1/8" x 1 1/2" PAINT LINE - EARLY PAINT - BEAD</p>	SPRINGS & WIRE	P164 (b)	RM 103
R022	RM 104, S WALL WINDOW APRON	<p>1/2" x 1 1/4" NO PAINT - EARLY PAINT - BEAD</p>		P164 (c)	RM 104

Room No.	Location	Material / Description	Quantity / Dimensions	Date	Project / Room
R023	N wall, west facade Rm 101 windows	grained boards		LATE G.R.	RM 101/2?
X R024	Rm 103, W chimney	curved cove molding (est?)		ca 1903	P229 EXT. CORNER
X R025	ca 1700 KITCHEN PTH	EXT CORNER PIECE?		ca 1903	P202 EXT. CORNER
X R026	(VOID - ca 1903)				
X R027	Rm 101 N wall - former door chimney (EMERGED ca 1880)	bsbrd ≈ 3' 9 3/4" L		ca 1880	P030 P356 RM 102
X R028	Rm 101 N wall - former door ashtray	bsbrd - sub piece of wood		ca 1880	P037 RM 101-2
X R029	Rm 101 - E wall	grained Revival mantel. opening: 31" H x 48 3/4" W		ca 1903	P043 P044 P220 RM 101 - N wall
X R030	Rm 101 - S wall	doorway ashtray		ca 1903	P134 P258 A - RM 103, S wall B - RM 101, S wall
X R031	Rm 101 - S wall	doorway arch molding (trim) - RIGHT SIDE		ca 1903	P259 RM 102
X R032	Rm 101 - E wall	bsbrd behind mantel (3' 7 3/4" L)		ca 1880	P156 RM 102
X R033	Rm 101 - E wall	bsbrd behind mantel (2' 1-1/2" L)		ca 1880	- RM 102
X R034	Rm 101 - E wall	grained door-frame w/ HINGE CUT-OUTS - GRADING 3" W. BEAD		ca 1880	P157 RM 102 - W wall
X R035	Rm 101 - E wall	FORMER DOOR STAMP (see over)		ca 1903	P158 P301 FORMER E WING?
X R036	Rm 101 - E wall	FORMER DOOR WALKER? REUSED AS DINING BRACING (over)		ca 1903	P160 RM 204?
X R037	Rm 101 - E wall	FORMER DOOR STAMP?		ca 1903	P159 RM 204?

RM 102
 ca. 1840 DOOR/WIND
 HEADER
 18 JAN '84

R030.B

4'8 1/2" L (up to TLH)

cut line a 500 x 20 mm into 35 1/8" W OPENING RM 102

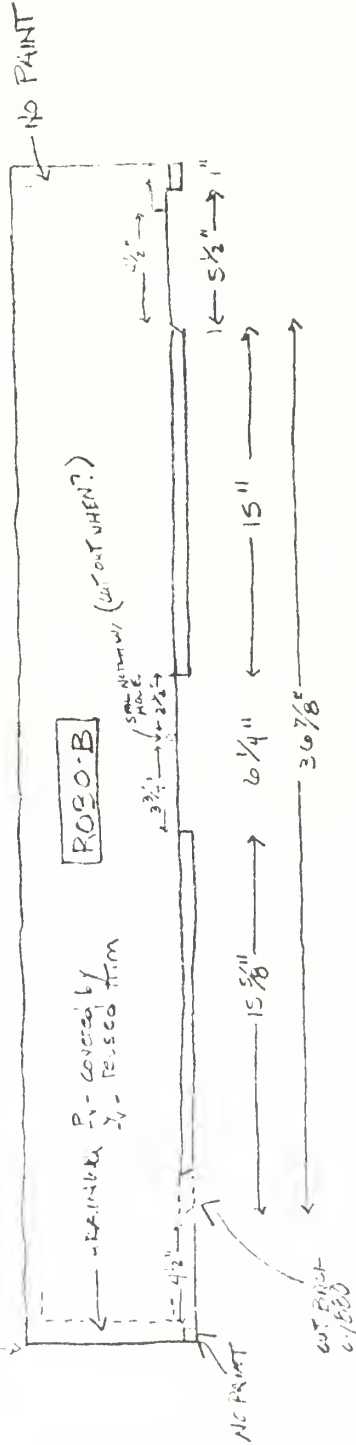

NOTCH FILLED w/ REUSED
 BEAD, HEAD w/ 1 SPCL
 1" WIRE NAIL

R035

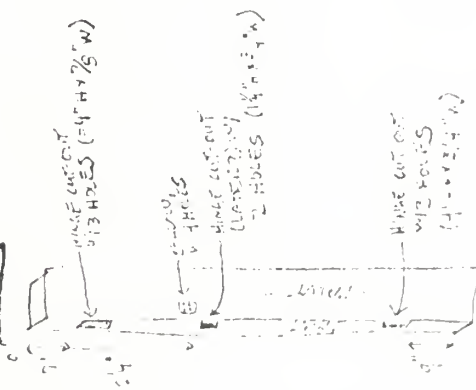

R033 TOP SIDE

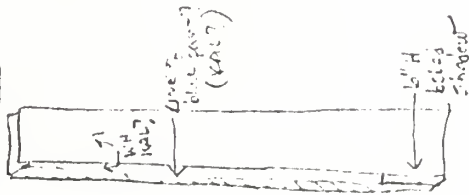

6 3/4 x 3 1/4 x 1\"/>

LEFT SIDE ARCHITRAVE

R036

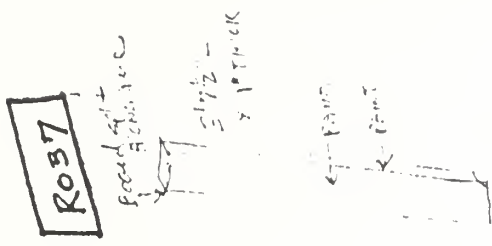
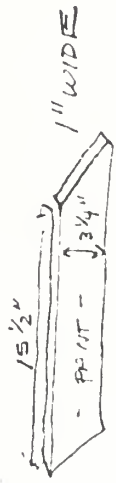

R043 A/C

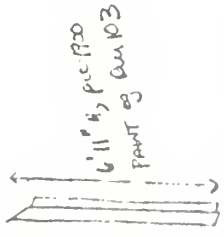

R043 B

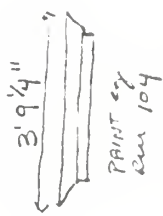

R044

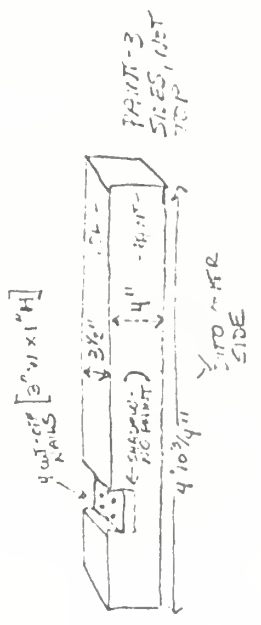

WORI 01 REUSED PAINTED WOODWORK

CATALOG NUMBER	REUSE LOCATION	WOODWORK DESCRIPTION	DATE REUSED	NAIL TYPE(S)	PAINT SAMPLE(S)	ORIGINAL LOCATION
R038	RM 103 - N WALL - AS STUD FOR A 1880 DOORWAY	door woodwork?	ca 1880		P253 (WO14)	RMS 101-2
X R039	RM 102 - CLOSET DECK	4-PINE DECK, 6'7" H x 2'7 1/4" W	ca 1903	P439, 440, 441, 442, 443	POST (A) POST (B)	RMS 201/2 (part: 07)
R040	RM 102 - CLOSET, W. WALL - ca 1880 - but reused 1903?	ca 1 1/2" LONG x 7 5/8" H (1/2 Painted 182)	ca 1903	Flat, shear		RM 102
X R041	RM 102 - W WALL	LAKAR banded, 2'1 1/2" L	ca 1880		P147	
R042	RM 102 - CLOSET	PLAIN ARCHITRAVE 1/2" (1880) PAINT 4" WIDE x 10 7/8" LONG x 1/2" THICK bead a 1/4" both edges	ca 1903		P153	RM ? (ca 1880)
R043	RM 104 - N WALL + B: TOP * A = 104 SIDE * C = RT SIDE	DOORWAY ARCHITRAVE (OVER)	ca 1903		(B) P302 (C) P165	A, C = RM 103
R044	RM 104 - N WALL - ALL STUD	FRAMING NUMBER [diagram of a rectangular frame with 'MAXIMIZE' written above it] 4'11" LONG	ca 1903		P160	?
R045	RM 105 - MAINSECT	TOP MAINSECT (formerly door/wind catchment including)	ca 1903		P073-A P073-B	RM 103
X R046	Hall 2nd Floor	Newel POST - STAIRS	ca 1903		P084	RMS 103/203 (STAIRS)
X R047ab	Hall 2nd Floor	DOWNRAIL + BALUSTERS, Reused IN HORIZONTAL POSITION - BR. SPACING = 6 1/4"	ca 1903		P085	RMS 103/203 (STAIRS)
X R048	Hall 2nd Floor	HORIZ RAIL - BALUSTERS spacing = 4 3/4", 19 1/2" LONG, just cut off	ca 1903		-	RMS 103/203 (STAIRS)
X R049	"Loose" - storage	Newel post w rail section of down-rail - shown off truss for rail, 1-sided base (truss)	N/A		P179	RMS 103/203 (STAIRS)
X R050a,b	"Loose" storage	Newel post + rail - baluster spacing 4 3/4" - shown off truss for rail, 2-sided base	N/A		P178	RMS 103/203 (STAIRS)
X R051	"Loose" storage	DOWN-RAIL + PORTION OF 1SE FIRE NEWEL POST ca 2'0" LONG	N/A		-	RMS 103/203 (STAIRS)

EXTANT RAILING, NEWELL POST 3' 3/4" H
 BALUSTERS SPACED 6 3/4" ON CTR
 Baluster = 2' 7" H
 RAIL = 7'-2 1/2" L

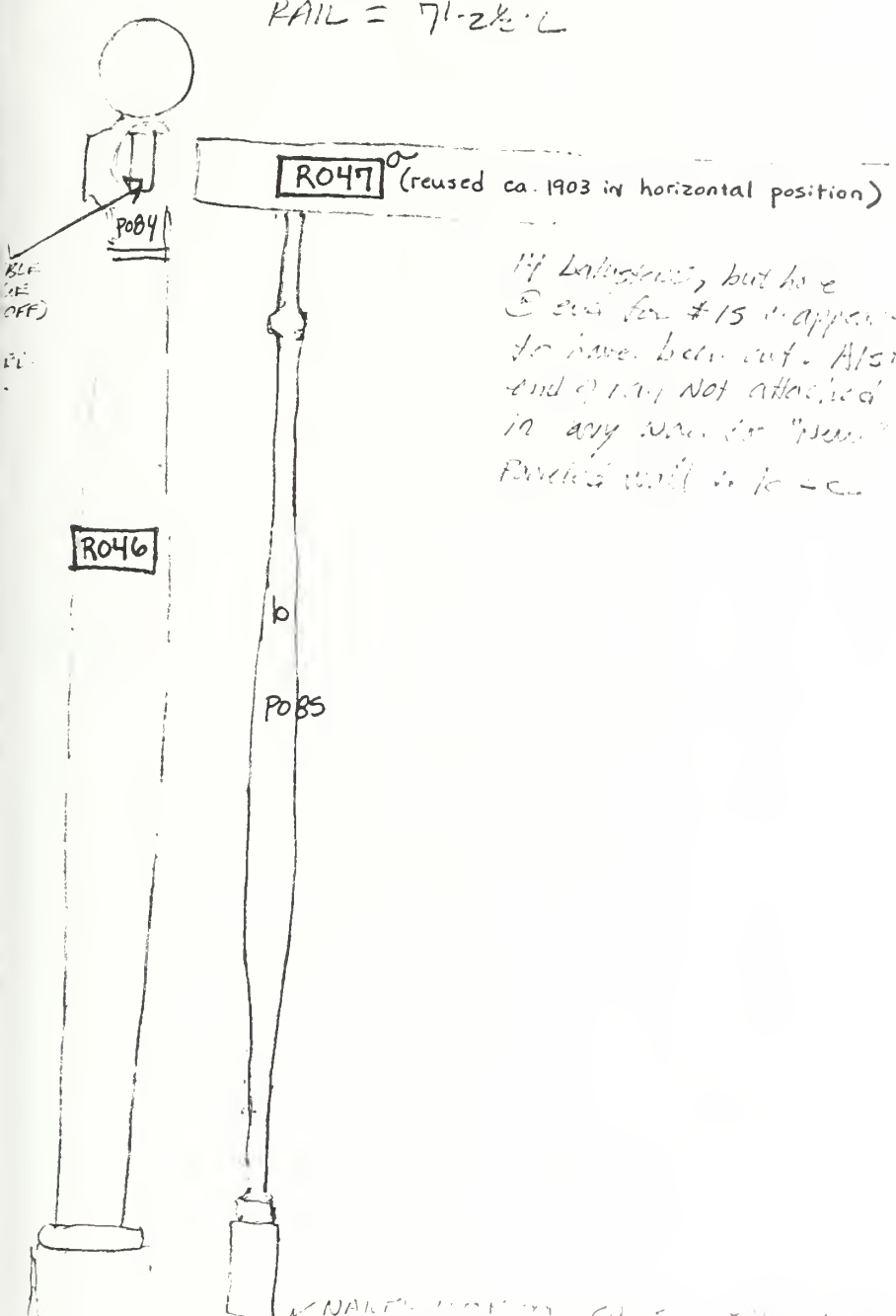

If balusters, but to e
 E end for #15 it appears
 to have been cut. Also
 end of rail not attached
 in any way to "new"
 Railing will be to e

← NAME POSITION ON ...
 WHERE POST WAS FORMERLY CONNECTED
 INTO RAILING

LOOSE RAILING MATERIAL:

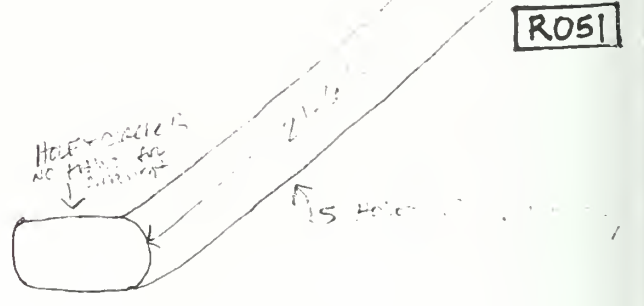
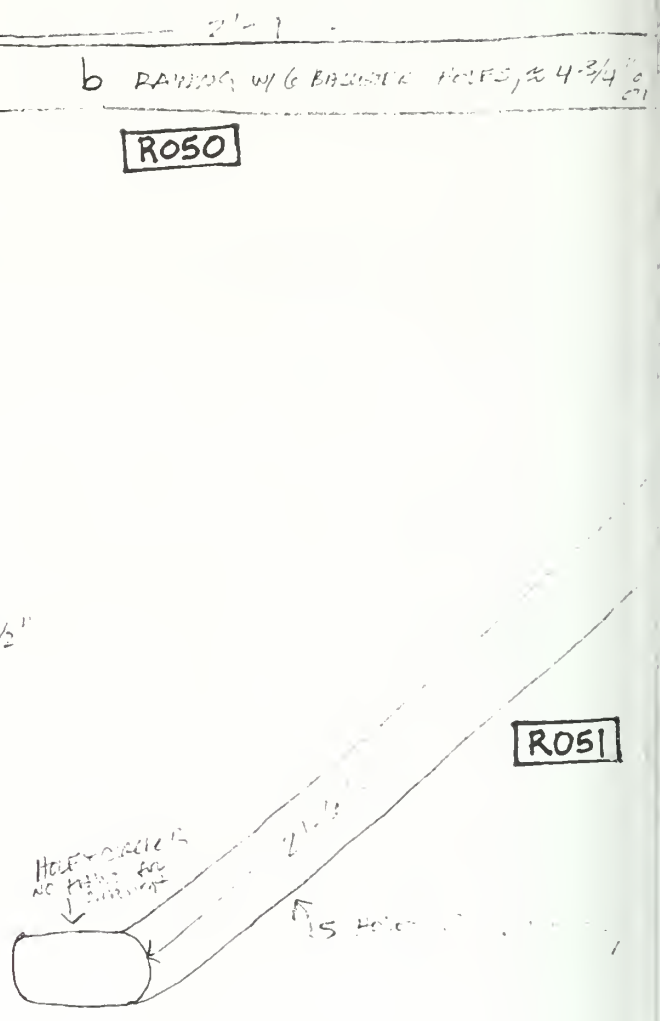

CATALOG NUMBER	REUSE LOCATION	WOODWORK DESCRIPTION	DATE	MAIL	PAINT	REMARKS
R053 (A) (B) (C)	Hall ca 1900 closet, 2ND FLOOR	INT DOORWAY ARCHITRAVE (ORNL)	ca 1903		(A) P303 (B) P304 (C) P305 P088	Factor? E MINUA?
R054	Hall ca 1900 closet, 2ND FLOOR	INT DOORWAY ARCHITRAVE (ORNL) DOORWAY ARCHITRAVE (ORNL) A = left B = top C = SIDE (RT)	ca 1903		P171 (C) P306	Rm 101
ROSS	Hall - in back 2ND FLOOR, former entrance (ca 1900) with RM 201	DOORWAY ARCHITRAVE (ORNL)	ca 1903		P172	RMS 201/2 (PARTITION)
R056	Hall - 5 WITH 2ND FLOOR, W WALL AS STUD	w/ beaded edge + w. paint for detail molding	ca 1903		P173	Rm 104
R057	Hall - 5 WITH 2ND FLOOR, W WALL AS STUD	w/ beaded edge + w. paint for detail molding	ca 1903		P174	Rm 104
R058	Hall - 5 WITH 2ND FLOOR, FORMER BATHROOM PARTITION (CA 1900) STUD	w/ beaded edge + wallpaper 2 1/4" WX 10 1/2" H x 1 3/16" THK	ca 1903		P226	Rm 202 (S WALL)
R059	Hall - 5 WITH 2ND FLOOR, W WALL AS STUD	FLOORBOARD 2' 6 1/2" (L) x 5 1/2" (W)	ca 1903		P232	2ND FLOOR
R060	Rm 201 - E wall (ca 1900)	DOORWAY ARCHITRAVE (ORNL)	ca 1903		P110	Rm 201/2 (W - CLOSET)
R061	Rm 201 - N wall - ca 1900 closet	BOARD - ROOM - SIDE 7' 9" L x 6" (S) H x 1" THK	ca 1903		P184	Rm 201
R062 (A) (B)	Rm 204 - ca 1900 closet	INT DOORWAY ARCHITRAVE - w/ detail molding	ca 1903		(A) P307 (B) P308 (C) P309 P118-B	C-RM 103 C.B. R4104
X R063	Rm 204 - ca 1900 closet	H-PANEL DOOR, 6' 7 1/8" H x 2' 2 3/8" W	ca 1903		P119-A P119-B	Rm 104 (S WALL)
R064	Rm 204 - ca 1900 closet	DOOR JAMB (INT)	ca 1903		P120	Rm 104 (S WALL)
R065	[See opposite sheet]					
R066	Rm 204 - E wall	Single TONGUE + GROOVE DOOR (ORNL) ca 1880	ca 1903		P199 P198	Rm 204 ca 1880
R067	Rm 204 - E wall	SIML DOOR ARCHITRAVE (ORNL)	ca 1903		(B) P311 P125	Rm 203

RO54

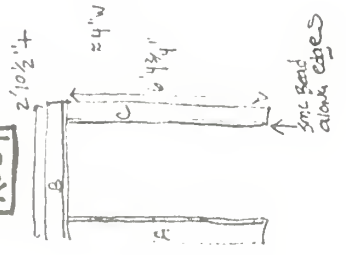

RO53

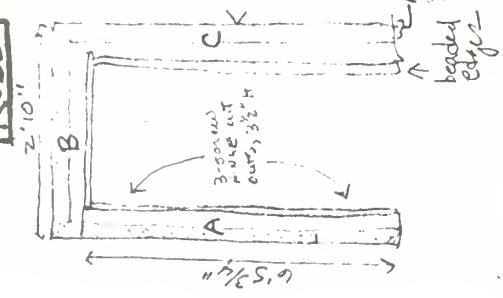

3 5/8" W
1 1/8" THICK

Wallpaper along edge

NO PAINT - FORMER
SPEC. MOUNTING - SPACING
NAILS
≈ 1 5/8" W

RO55

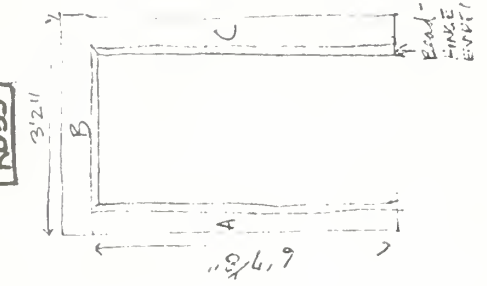

FRAMING - VERY CAREFUL
UP FROM FLOOR - 1/2"
QUALITY KAL PAINT
ON EDGES

RO60

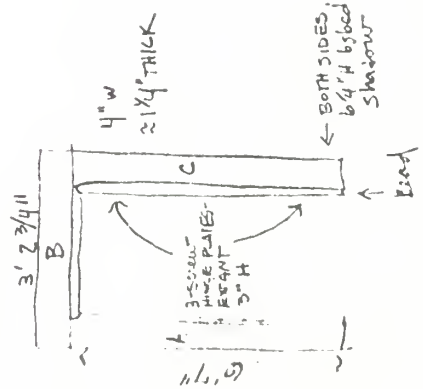

A - 60# 5 1/2" STATIC PAPER

B - 60# 20# YL DUST

H - 60# 1/2" KAL PAINT

RO64

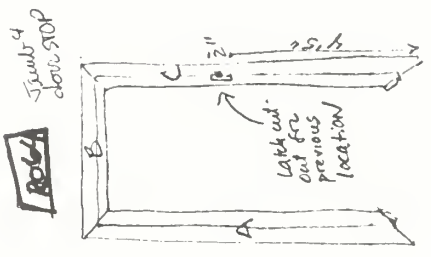

RO66

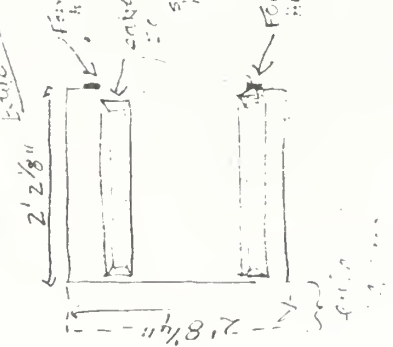

RO67

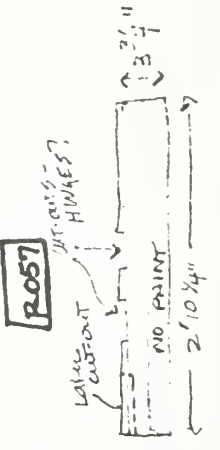

RO56

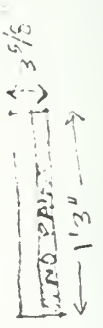

RO67

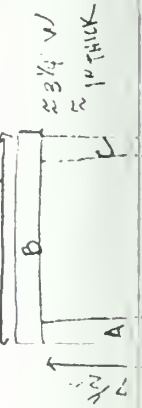

ROWS #10 + #11 Bu 104 Floor - (2) Formwork (North), C-2 Joints



(A) P310

NONE

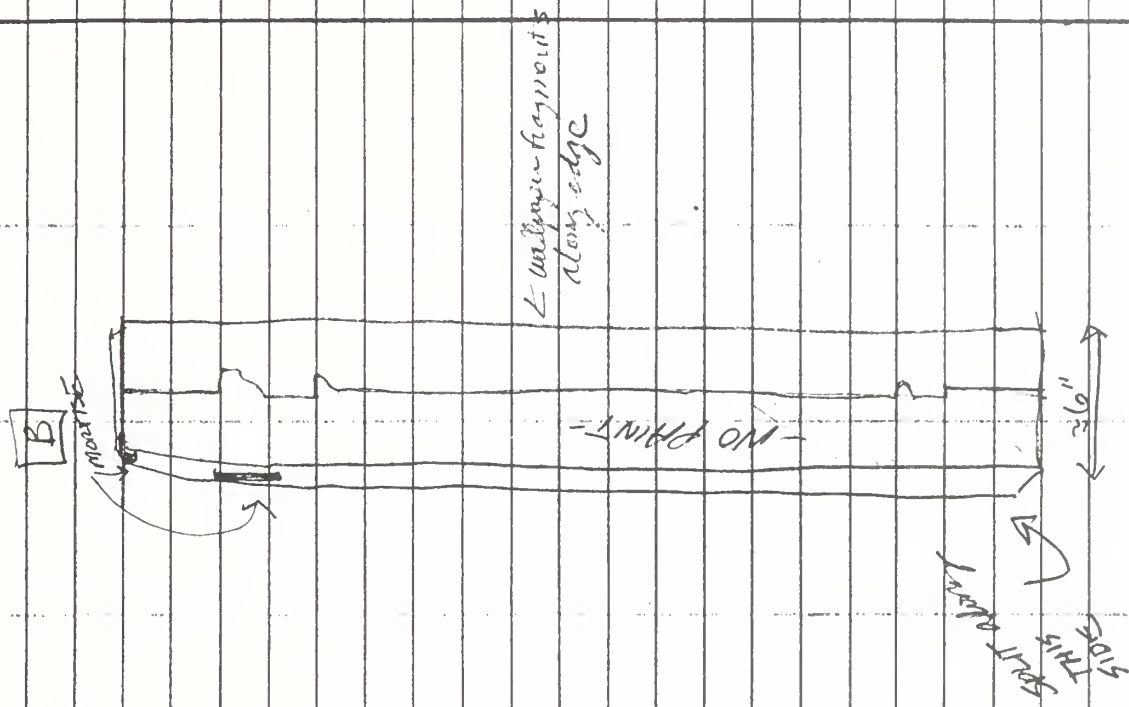
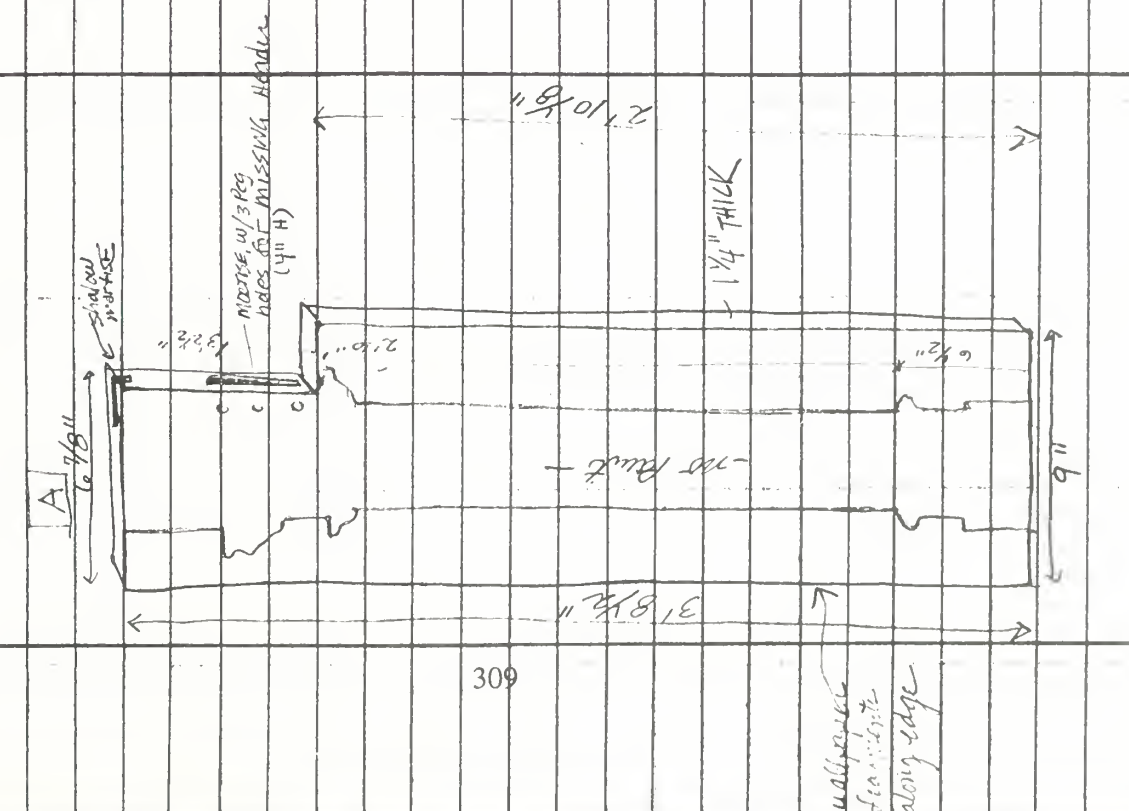
RM 104

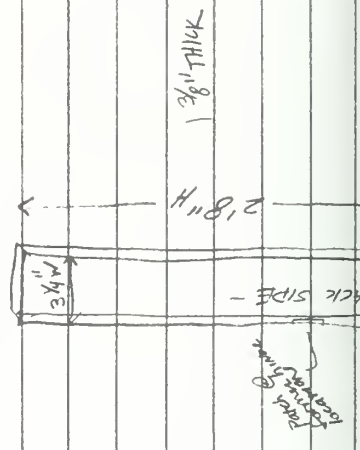

WORI 01 REUSED PAINTED WOODWORK

CATALOG NUMBER	REUSE LOCATION	WOODWORK DESCRIPTION	DATE REUSED	NAIL TYPE(S)	PAINT SAMPLE(S)	ORIGINAL LOCATION
R068	RM 204 E wall SWL DOOR	TOP HINGE, w/ 4 SCREWS 	ca 1903		P200	RM 103
R069	RM 204 E wall SWL DOOR	BOTTOM HINGE, w/ 3 SCREWS 	ca 1903		P201	?
X R070 (104)	RM 204 - KIT ATTIC	TONGUE & GROOVE BOARD Removal N. wall	ca 1903		P203	RM 7 1980
R071	RM 202 - E wall BSBLD (ADJ. TO PARTITION) EVIDENCE - "3 2 3"	7 1/2" H (wall)	ca 1903		P272 P280	RM 103/203 (STAIRS)
R072	RM 202 - N wall @ E corner, SWL PATCH	6 1/4" H x 2 1/2" W x 1" deep	ca 1903		P283	RM 103/203 (STAIRS)
R073 (R074)	ATTIC CEILING BED above bath + 204 CL	DOOR ALUMINUM w/ BEAD - beveled on plaster side - Rubber @ former hinge locations (corner)	ca 1903		P284 P287	RM 203 (N wall)
R074	ATTIC	DOORWAY HINGEL BOARD (corner)	ca 1903		P285	
R075	ATTIC A B C	DOOR JAMBS (corner)	ca 1903		P286	RM 202 (S wall)
R076	ATTIC	DOORWAY Threshold (corner)	ca 1903		P288, P315	RM 202 (S wall)
R074	RM 101 S wall, ca. 1980 threshold flange-bed (beneath)	FORMER door frame 	ca 1980	UNIT, FLAT, SHEET	P313 P314	FORMER? E wing?

Ro71

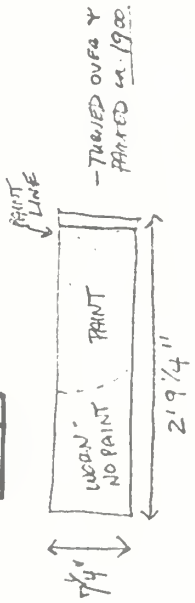

Ro75

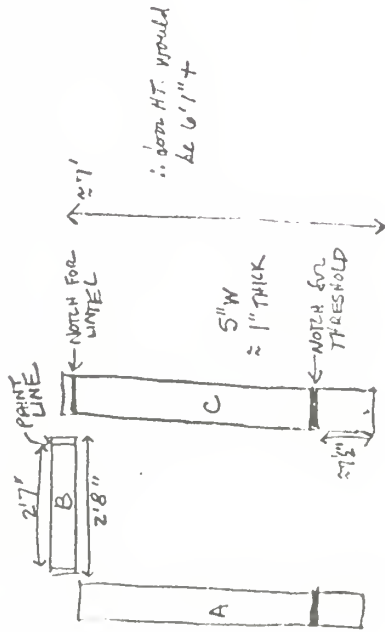

Ro73

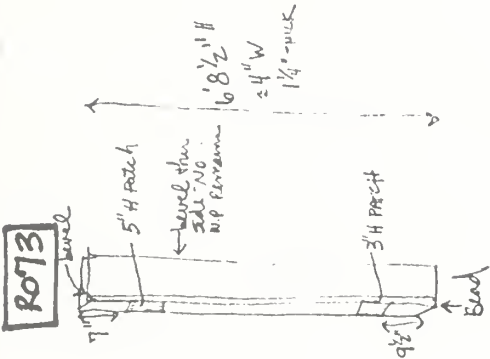

Ro76

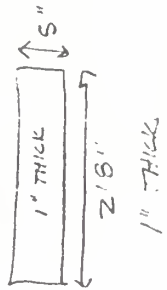

PAINT ON FACE OF
BLOCK THAT WOULD
HAVE FACED INTO
ZOE

WOR 01 REUSED PAINTED WOODWORK

CATALOG NUMBER	REUSE LOCATION	WOODWORK DESCRIPTION	NAIL TYPE(S)	PAINT SAMPLE(S)	ORIGINAL LOCATION
RC17	Rm 101, ca 1880 door jamb note	<p>3' 4 3/4" 880 paint jamb beaded edge about 1/2" THICK</p>		P316	Rm 102
RC18	Rm 14, ca 1880 door trim pieces			(A) P317 (B) P318 (C) P319	Rm 101/2
(A)	1' 8 1/4" H	(D) 1' 2 1/2" L			
(B)	5' 10 1/4" H				
(E)	8" L	(G)			
RC19	Rm 14, ca 1880 door "inner door" hardware board	<p>FORMER. SEE HARDWARE LOCATION? bead PAINT LINE 3' 4" long x 3 1/2" wide X section</p>		P320	Rm 103
RC20	BRIDGE, ca 1903 STUDS	<p>2' 1 1/4" 2 3/4" wide bead PAINT CUT OUT FOR BRIDGE? 4 3/8" L</p>		P321	Rm 103
<p>NOTE - RETAINING CUT-OUT. SEE BRIDGE & BOARD, 9 3/4" x 3 1/2" (CHINA CUT CUT) (SPLIT IN) (JUL)</p>					

CATALOG	DESCRIPTION	TYPE(S)	SAMPLE(S)	LOCATION
ROB1	Rm 101 ca 1980 doorway under threshold	Flat, smooth	P322	Rm 101/2
ROB2	ca 1900 STAIRWAY TRIM		P323	Rm 104
ROB3	Rm 102, ca 1900 closet partition		P324	Rm 102
ROB4	R E wall betw Rm 101 & 102	<p>PLANK from ca 1880 board 4 in. diam door, REUSED ca. 1900 - PAINT BOTH SIDES; TONGUE & GROOVE edge</p>	P325	Rm 102
ROB5	E wall, betw 101 & 102 - attached to studs		P326	E WALL E WALL
ROB6	E wall, betw. 101 & 102 - attached to studs	<p>same piece, appears to have been ripped/sawn</p> <p>1' 11" L x 1 1/8" THICK</p>	P327	Rm 201/2 R 203
ROB7	Rm 102, closet door header frame	PAINTED ON UNDERSIDE 2' 4 1/2" L x 2 1/4" W x 3/4" THICK	P328	Rm 104
ROB8	ca 1910, IV E wall	<p>disintegrated fragment (grained) w/ 11/16" cut out (3 1/2" H)</p> <p>WOOD FRAG = 1' 10" LONG</p>	P329	Rm 103

WORI 01 REUSED PAINTED WOODWORK

CATALOG NUMBER	REUSE LOCATION	WOODWORK DESCRIPTION	NAIL TYPE(S)	PAINT SAMPLE(S)	ORIGINAL LOCATION
RC10	Rm 102 - West side (ex HCC) Entry from reuse side	<p>OUTSIDE → W.P. FURZE HT = 7'9 1/4" 5 1/8" W 1" THICK</p>		P330	Rm 104 - 5 WALL
RC11	Rm 102 - E wall in 1960 enclosure	<p>WOOD JAMB (6' LEADS) - PAINT WOOD - PAINT PAPER HEAD 1 1/4" L, 4 1/4" W CUT OUTS 1/2" THICK (WINDOW JAMB?)</p>	CAPTIVE - RAIL ROUND	P331	Rm 104 - 5 WALL
RC12	Rm 102 - E wall in 1960 enclosure	<p>HEAD 1 1/4" L, 4 1/4" W CUT OUTS 1/2" THICK (WINDOW JAMB?)</p>		P332	Rm 104
RC13	Rm 102 - E wall in 1960 enclosure	<p>ditto RC11 BUT NO CUT-OUTS - 2'6 1/2" L</p>		-	Rm 104

WORI 01 REUSED PAINTED WOODWORK

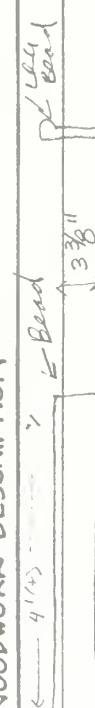
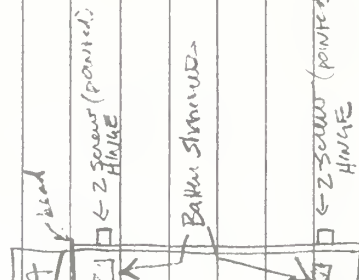
CATALOG NUMBER	REUSE LOCATION	WOODWORK DESCRIPTION	NAIL TYPE(S)	PAINT SAMPLE(S)	ORIGINAL LOCATION
R011	Rm 104 (Elevators) 	← 4 1/4" ← Bead 1/4" board		P339	Rm 103
R010C (A) (B) (C)	Rm 104 (Elevators)	7/8" (C) THICK TONGUE & GROOVE BEARING APPLICABLE TO ALL FORM BOARD & MILLER DOOR		(A) P340	Rm 102
B	1'5 3/4" L x 2 3/4" W - HINGE CUT-OUT ONE SIDE				
C	2'5 3/4" L x 2 3/4" W (A-C CUT-OUT)	3'11 1/2" L x 3 3/4" W x 3/4" THICK Baker Staircase ← 2 5/8" HINGE (pointed) ← 2 5/8" HINGE (pointed)			
R101 (A) (B) (C)	1/2 Flat Head CREST - DOOR - TURNBOLT NUT	Hinge = JAMBS, B = Header A = 6'4 5/8" L x 2" W (Paint Line @ TOP indicates fastener location) B = ? Long? - Width of door = 2'2 1/4"		(A) P341 (B) P342 (C) P343	Common hallway
R102	Interior framing for ceiling and floor in 1900			P344	Rm 104 - 5' wall (L side)

NUMBER	LINE LOCATION	WOODWORK DESCRIPTION	NAIL TYPE(S)	PAINT SAMPLE(S)	ORIGINAL LOCATION
R103 (A)	Rm 204, N wall doorway	<p>3'2 1/8" 2'6" 4" W X 7/8" THICK A B C Bead ca 1900 Bead</p>		(A) P345	RMS 201/2 (partition)
(B)	switchplate to hall			(B) P346	
R104 (A)	Rm 204, N wall doorway -	<p>2'6" 2'4" 1/6" x 3/4" A B C PINKY PAINT COVERED BY ca 1900 DOOR STOP</p>		(A) P347	RMS 201/202 (partition)
(C)	Jamb & header				
R105 (A)	Rm 201, E doorway to hall -	<p>2'6 1/2" 2'4" 1/6" x 1/2" A B C</p>		(A) P348	RMS 201/2 (partition)
(B)	Jamb & Header				
(C)					
R106 (A)	Rm 204, attic doorway jamb & f	<p>2'4 7/8" 2'11 1/4" 3 3/4" W A B C wallpaper on edges lip cut out</p>		(A) P349	a. RM 203 (c. 1900)
(B)	trim, E wall			(C) P350	
(C)					

WORI 01 REUSED PAINTED WOODWORK

CATALOG NUMBER	REUSE LOCATION	WOODWORK DESCRIPTION	NAIL TYPE(S)	PAINT SAMPLE(S)	ORIGINAL LOCATION
R107	CEILING RM 203, LATH NAILER	<p>GRAINING 2" W 3' 3/2" L X 2" W X 1/4" THK LIP PAINT "LIP" CUT X-SEC.</p>		P 351	RM 103 (door jamb)
R108	2ND FLOOR HALL CEILING, SO WING, CEILING NAILER (B5BED?)	<p>GRAINING THIS edge beveled, as to butt joint WH PAINT BEAD 9/4" 5' 6" L X 6 1/2" W X 7/8" THK</p>		P 352 (1) + (b)	RM 103
R109	Bath & Hall (2nd FLR, SO WING) CEILING BED	<p>GRAINING 1 7/8" 1' 1 1/2" L X 1 7/8" W X 1/4" THK "LIP" CUT X-SEC.</p>		P 353	RM 104 - 5 WALL
R110	Closet Hall, (2nd FLR) CEILING BED	<p>DITTO R109 2' 7/8" L X 1 3/4" W X 1/8" THK</p>		P 354	RM 104 - 5 WALL
R111	Bath & Hall (2nd FLR) CEILING BED	<p>DITTO R109 2' 1" L X 1 7/8" W X 1/4" THK</p>		P 355	RM 104 - 5 WALL
R112	RM 204 E wall, crane space door saddle	<p>GRAINING LIP SPRINGS = 3/4" 1 7/8" L X 1 7/8" W X 1/8" THK CUT-OUT for hinges? 9/16" L X 1/8" W (DOOR JAMB?) 2 3/4" L X 2 1/2 7/8" L</p>		P 356	RM 103 (door jamb)
R113	ATTIC, ABOVE RM 105 - LATH NAILER (RM 103, 105)	<p>GRAINING LIP 2' 5 1/4" L X 1 7/8" W X 1/8" THK (Header?)</p>		P 357	RM 103, N wall (Jamb header)
R114	RM 203 on N wall by CHIMNEY	<p>GRAINING LIP 1 7/8" L X 1 1/4" W X 1/4" THK 2 3/4" L</p>		P 358	RM 103 (door jamb)

NUMBER	NAME / LOCATION	TYPE(S)	SAMPLE(S)	LOCATION(S)
R115	Lath Nailer, Rm 203	CUT R POINTS	P 351	Rm 103 (door jamb)
R116	Bathroom ceiling Board (cut in window?)	CUT R POINTS	P 360	Rm 103 (STAIRS)
R117	2nd FLR - Bath & Bdrm closet - CEILING BOARD WINDOW ARCHITRAVE?		P 361	Rm 104
R118	"NORTH ROOM, SOUTH WALL, HALL DRAWING LATH NAILER" RM?		P 362	FORMER E WING?
		Edge molding w/ Rm 104 wallpaper fragments on edge 3' 1" L +, 1 7/8" W		
R119	Rm 104, so. wall, E corner by chimney, used as lath nailer		P 363	Rm 104
		Edge molding - small fragment & 11" L - same wallpaper on edge		
R120	"Floorboard Reused for blocking"		P 364	Rms 201/202 (closet, N wall)
		<ul style="list-style-type: none"> "WHITE/cream paint" - scraped along perimeter over yellow, as if bled or something packed 		
	SMALL CLOSET?			



WORI 01 REUSED PAINTED WOODWORK

CATALOG NUMBER	REUSE LOCATION	WOODWORK DESCRIPTION	NAIL TYPE(S)	PAINT SAMPLE(S)	ORIGINAL LOCATION
R121	"Used as lath nailer at ceiling on outside span betw. RMS 103 & 104	<p>1' 2 7/8" L X 3 5/8" W X 1 3/16" THK (one surface = smooth, one surface = rough)</p>		P 365	RMS 103/203 (STAIRS)
R122	Rm 201 former hearth area - attached to floor - joist	DITTO R121, but 4 1/4" L		P 366	RMS 103/203 (STAIRS)
R123	"Span betw 104 & 105"	Former door architecture or bsked molding fragment - w/ bead		P 367	Former E WING ?
R124	Rm 201 - trim "bkskd" closet & HALL	<p>2 1/2" L X 6 1/2" W X 1" THK</p>	CUT - ROUND POINTS	P 368	RMS 103/203 (STAIRS)
R125	"ATTACHED TO CEILING IN HALL WINDOW STUD, SO SIDE"	<p>4 7 3/16" L X 2 7/8" W X 1" THK</p>		P 369	RMS 103/203 (STAIRS)
R126	TRIM BY STAIRWAY WALL CLOSET, 2ND FLR	<p>3 1 7/8" L X 6 1/2" W X 1" THK</p>		P 370	RMS 103/203 (STAIRS)
R127	Rm 201, removed from ceiling over chimney	<p>7 7" L X 4 7/8" W X 1 1/8" THK</p>	CUT, ROUND POINTS	P 371	RMS 103/203 (STAIRS)

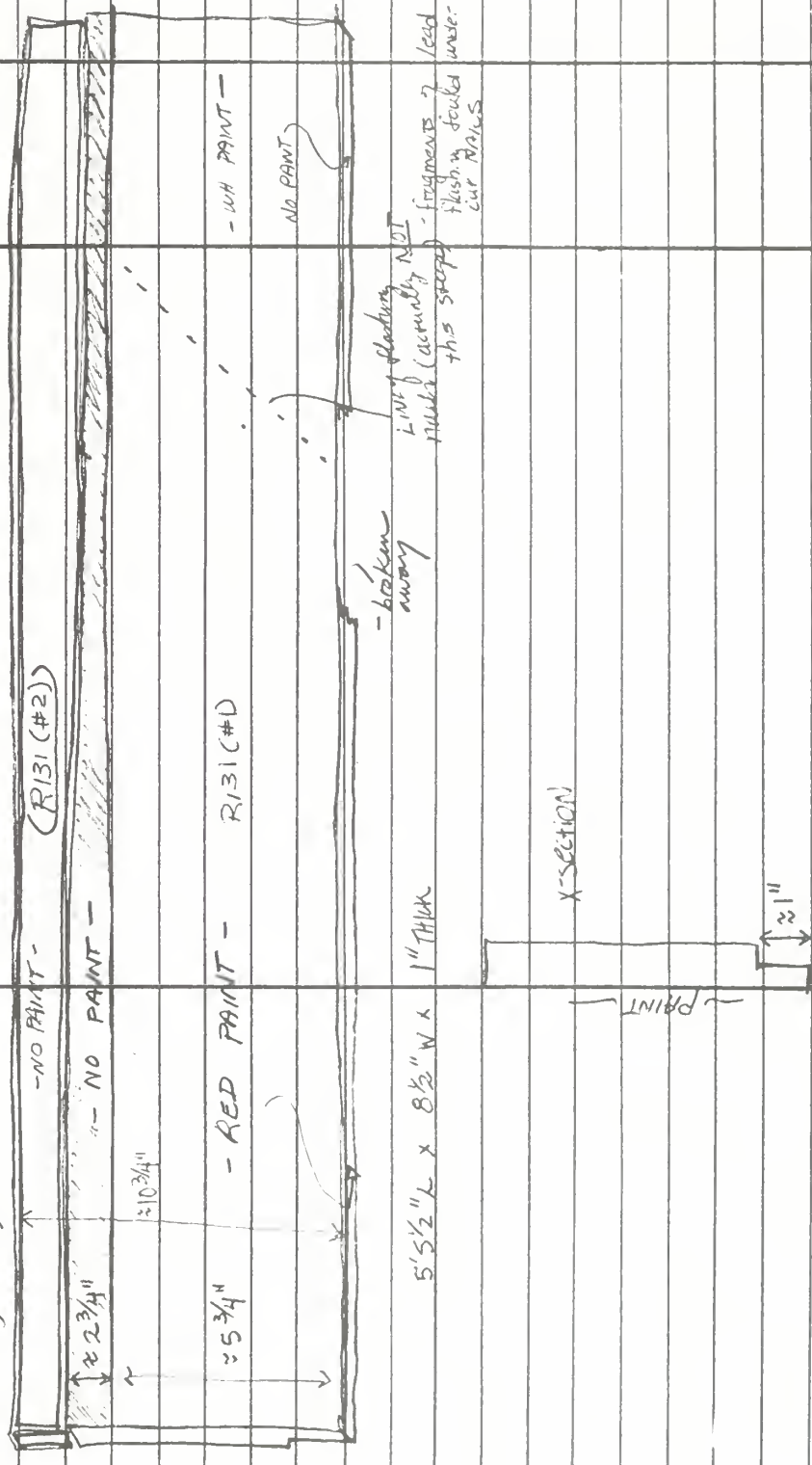
NUMBER	NAME LOCATION	NO FINISH (I W)	TYPE(S)	SAMPLE(S)	LOCATION
R128	50 wing, so gable end, reused 1903 as sheathing for siding	NO FINISH (I W) - PAINT - NAIL FRAGS, NO PAINT (ditto other side) 1 1/2" INTERVALS 3'7" L X 8 1/4" W (-X) 3/4" THICK	CUT	P372	EXT - SOFT ?
R129	7 1/2" house, w gable end, reused as sheathing	- NO PAINT - - PAINT - 1 1/4" EXPOSED PAINT PAINT (44) 4 1/4" W X 8'13"10" L X 1/4" THICK	CUT	P373	EXT - CORNICHE ?
R130	BENT ceiling, @ Room 102	FRONT door ext front door pilaster fragment, @ 3' long X 3" WIDE	CUT	P374	EXT - PLASTER (front door)
R131(A)	50 wing @ Roof Ridge by N. wing - Reused as roof beams, sheathing (frag of wood shingles + w/wise shingle nails)	- NO PAINT - - NO PAINT - - RED PAINT - 5'5 1/2" L X 8 1/2" W X 1" THICK	- WH PAINT - NO PAINT	P375	EXT - PAINTED BOARD (p. 500 N w. of I.S facade)
(#2)		NO PAINT - NO PAINT - RED PAINT - 5'5 1/2" L X 8 1/2" W X 1" THICK	- WH PAINT - NO PAINT - broken away LINE of flooring NOT made (actually NOT this steep) fragments of lead flash in fouled under cut RAIS		
			X-SECTION		

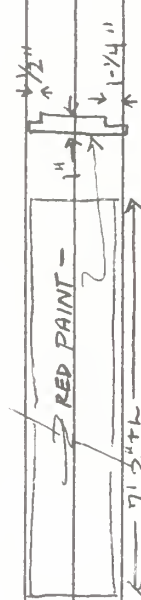
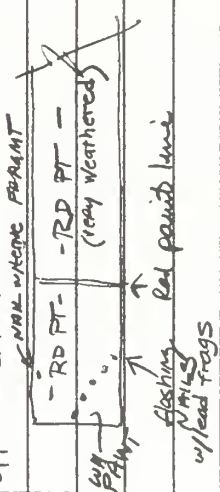
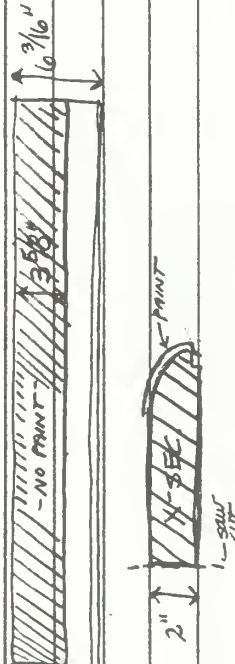

WORI 01 REUSED PAINTED WOODWORK

CATALOG NUMBER	REUSE LOCATION	WOODWORK DESCRIPTION	NAIL TYPE(S)	PAINT SAMPLE(S)	ORIGINAL LOCATION
R132	SO WIND; SO GABLE, for sheathing	NO PAINT THIS SIDE - L24 CUT NAILS CUT OFF  <p>5'5" L, 4 7/8" W x 1" THK RED PAINT - 3 I.P. 1/4" X-SECTION</p>	CUT	P 376	EXT - soft?
R133	at R03 kitchen wing roof sheathing board (filled w/ R03 course shingle nails)	 <p>7'5 1/4" L RED PAINT - 1" T 1/2" T 1/4" T</p>	CUT	P 377	EXT - cornice?
R134	Main house, W gable end	ditto R132, but 10'1 1/4" L	CUT	P 376	EXT RAKE?
R135	SO WIND. SO GABLE end	ditto R131, but 7'5 1/4" L, & flashing nails & RUN IN opposite direction  <p>RD PT - (very weathered) flashing Nails w/ lead frags MAX WHERE PARANT</p>	CUT	P 377 (a) P 377 (b)	EXT - Frieze Board (preserv N wing, S facade)
R136	Attic above R0105 - used as blocking for bath	 <p>6'3/16" L NO PAINT 2" T 1" saw cut PAINT</p>		P 380	EXT - cornice (gutter?)
R137	Main house, west gable	ditto R129 - looks like R129 spliced together level  <p>NO PAINT RED PAINT bevel</p>		P 381	EXT - cornice?

CATALOG #	DESCRIPTION	TYPE(S)	SAMPLE(S)	LOCATION
R138	50' width - Required dry roof - sheathing board - pieces of wood shingles on painted face.	<p>similar to R133, but paint lines different</p>	P 382	EXT - cornice
R139	E 903 KIRITANU WING, used as Roof sheathing board		P 383	EXT - cornice?
R140	Closest shecl. 2nd floor.		P 384	EXT RALE BOARD
R141	RM 105, 4th corner bracing, NW CORNER		P 385	EXT - cornice?
R142	6A 903 KIRITANU WING EXTENSION - EXT		P 386	EXT - cornice

WORI 01 REUSED PAINTED WOODWORK

CATALOG NUMBER	REUSE LOCATION	WOODWORK DESCRIPTION	NAIL TYPE(S)	PAINT SAMPLE(S)	ORIGINAL LOCATION
R143	Rm 105 Floor spacer	<p>WOODWORK DESCRIPTION: - NO PAINT - (NO PAINT) 1' 1 3/4" L (cut) 3 3/4" 3 1/2" 1/8"</p>		P 367	EXT-SHIRT BRD?
R144	Rm 105 Floor spacer	DITTO R143, but 1' 3 3/4" L		None	EXT-SHIRT BRD?
R145	Rm 105 Floor spacer	DITTO R143, but 1' 2" L		None	EXT-SHIRT BRD?
R146	Rm 105 Floor spacer	DITTO R143, but 1' 2" (cut) L		None	EXT-SHIRT BRD?
R147	Rm 105 Floor spacer	DITTO R143, but 1' 1 3/4" L		None	EXT-SHIRT BRD?
R148	Rm 105 Floor spacer	DITTO R143, but 11 1/2" L		None	EXT-SHIRT BRD?
R149	Rm 201	DITTO R143, but 5' 10" w/ end bender (eg for joining?)	OUT, SHARP POINT	None	EXT-SHIRT BRD?
R150	1903 SPACERISE - BLOCKING BETW STUDS, EAST SIDE	<p>WOODWORK DESCRIPTION: - NO PAINT - (NO PAINT) 1' 1 1/2" L (cut) x 3 1/2" W x 1" THK X-SEC 1/2"</p>		P 367	EXT-CORNICE?
R151 (a)	Rm 105 Set wall, both numbers	<p>WOODWORK DESCRIPTION: X-SECTION (Full scale) UPPER PAINT GOOD CONDITION PAINT (W/ TRD)</p>		P 367	EXT-FRONT doorway head
R151 (b)		(a) = 4' - 10 1/4" L (b) = 1' - 1/8" L			

CATALOG	WHERE THE EVIDENCE	TYPE(S)	SAMPLE(S)	LOCATION
R152	1705 KOSTERIN WING - GROUND BUILDING LOCATION ON N. SIDE OF SHUT ROOM EXHIBITION	QUARTER ROUND 	P390	EXT- CORNIC
R153	HALL closet trim (bldg. wall), SO. WALL	cut ← PAINT → ← NO PAINT → 3' 2 3/4" L (cut) x 6" W (cut) x 7/8" THK BSBRD?	P391	RM 204
R154	Rm 201 N. wall. bsbrd	cut ← PAINT → ← NO PAINT → 2' 4" L (cut) x 6 3/8" W x 1 1/16" THK also grey & tan paint BSBRD?	P392	RMS 201/202
R155	Rm 203 ceiling tile. Fuzerini	Rm 203 wallpaper (chinese) - along one edge, pu + paint evidence 6' 7 1/2" L x 5 3/8" W x 1 5/16" THK	P393	RM 203
R156	" closet bsbrd trim" [no rm given]	4 1/4" W NO PAINT ← GRAY PAINT → ← GRAY PAINT → 2' 4" L x 6 1/2" H x 1" THK also, pu + gray side paint tile, etc. 201/202	P394	RMS 201/202 (N WALL)
R157	" used as bath N. wall. near ceiling in 202 spid with blue, white, etc. [?]"	← PAINT → ← GRAY PAINT → 2' 1" L (cut) x 4" W x 1 1/2" THK also bsbrd also bsbrd & 1/4" x 1/4" tile PAINT	P395	RMS 201/2
R158	Rm 20 bsbrd, N. wall	← GRAY PAINT → 4' 2 1/4" L x 6 3/8" (H) W x 1" W also gray & tan paint	P396	RMS 201/202

WORI 01 REUSED PAINTED WOODWORK

CATALOG NUMBER	REUSE LOCATION	WOODWORK DESCRIPTION	NAIL TYPE(S)	PAINT SAMPLE(S)	ORIGINAL LOCATION
R151	RM 201 - ceiling over entrance	<p>2x4 1/2" L x 4" W x 1 1/2" THK</p> <p>Door edge paint</p> <p>2x4 1/2" L x 4" W x 1 1/2" THK</p> <p>Bead cut on need: left side only, skip</p>	CUT BEARD RIMMS	P 377	RM 201/202 (N wall closet)
R160	LOBBY AREA, RM 204 W WALL	<p>2x2 1/8" L (cut) x 5 3/4" W x 7/8" THK</p> <p>NO PAINT</p> <p>BEAD</p> <p>NO PAINT (THIS EDGE REVEALED)</p> <p>(bead)</p>	CUT BEARD RIMMS	P 399	RM 204
R161	RM 105 (WALL) CLOSET TRIM - EAST WALL	<p>2x1 9/16" L x 6 1/2" W x 7/8" THK</p> <p>NO PAINT</p> <p>BEAD</p> <p>NO PAINT (THIS EDGE REVEALED)</p> <p>(bead)</p>		P 400	RM 105/203 (STAIRS)
R162	RM 105 - FLOOR SPILLERS, WOOD WALL	<p>1x2" L (cut) x 4" W x 1 1/2" THK</p> <p>DOOR EDGE PAINT</p> <p>BEAD</p> <p>DOOR EDGE PAINT</p>		P 401	RM 201/2
R163	ATTIC SPACE ABOVE RM 105 NORTH EAST WALL	<p>2x1 L (cut) x 4" W x 1 1/8" THK</p> <p>DOOR EDGE PAINT</p> <p>BEAD</p> <p>DOOR EDGE PAINT</p>		P 402	RM 201/2
R164	Attic closet trim (bead) E wall	<p>2x1 L (cut) x 4" W x 1 1/8" THK</p> <p>DOOR EDGE PAINT</p> <p>BEAD</p> <p>DOOR EDGE PAINT</p>		P 403	RM 204

CATALOG	DESCRIPTION	TYPE(S)	SAMPLE(S)	LOCATION
R165	Rm 201, closet trim (inside)		P404	Rm 201 25/202
R166	hall closet trim No. 714 wall		P405	Rm 204
R167	ATTACHED TO Rm 202 - BUSBY'S OFFICE small trim (1963)		P406	
R168	UNDER BATH FLOOR - BATH		P407 (A) (B)	Rm 103 (E. WALL) (WINDOW)
R169	Rm 204, E. WALL - STUD PICKL		P408	
R170	Rm 204, E. WALL, UNIT NO. 1011 VALVES		P409	Rm 203?



3' 7 1/2" L (cut) x 6 1/2" W x 15/16" W

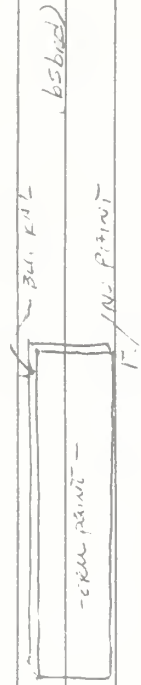

3' 3 3/4" L (cut) x 6" W x 7/8" THK

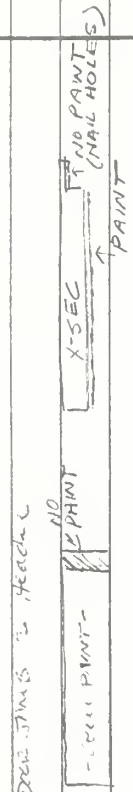

1' 10" L (cut) x 4" W x 1 3/8" THK

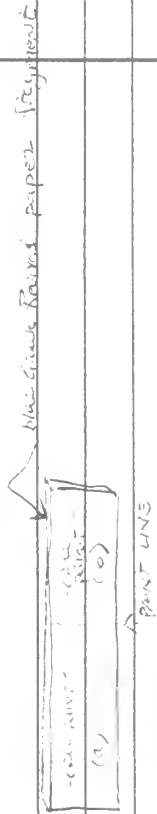

2' 2 3/8" L (cut) x 3 3/8" W (NET CUT) x 13/16" THK

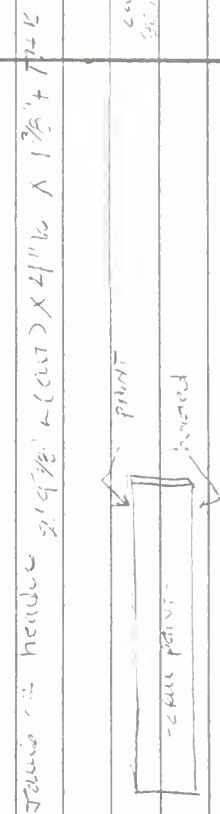

2' 0 3/4" L (cut) x 4 1/8" W x 1/4" W

CATALOG	TYPE(S)	SAMPLE(S)	LOCATION
R176	RM 204, S/E corner stud block	P414	?
R177	SO CORNER HEAD & BRASS CEILING	P415	RM 201/202 (N wall closet)
R180	BRASS FLOOR TRIM - IE WALL	P416	RM 202 (S WALL)
R181	RM 204, SW WINDOW HEADER TRIM (S/W SIDE)	P417	RM 104 - (S wall)
R182	RM 202, WINDOW, behind TRIM	P418	RM 201/2
R183	RM 105, FOUND WINDOW N WALL UNDER FLOOR TRIM	P419	RM 201/202 (N wall closet)
R184	RM 105, BRASS NORTH WALL	P-120	RM 204

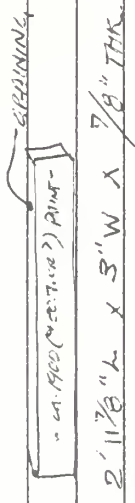
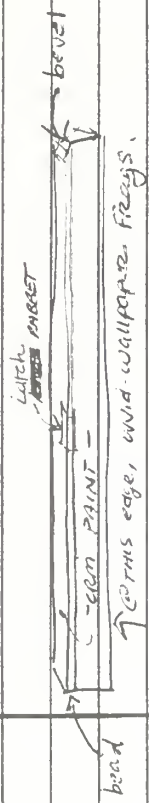
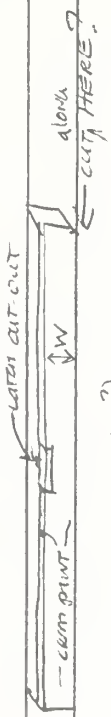

WOOD fragment
along ONE edge
same paint

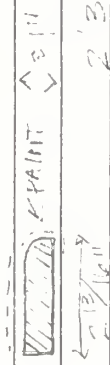
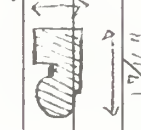
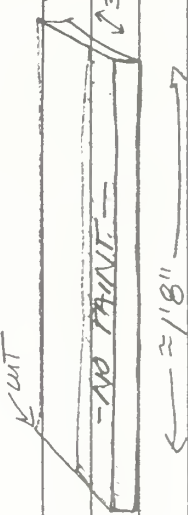
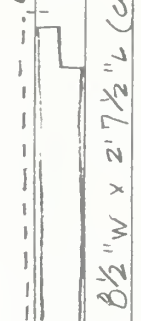

WORI 01 REUSED PAINTED WOODWORK

CATALOG NUMBER	REUSE LOCATION	WOODWORK DESCRIPTION	NAIL TYPE(S)	PAINT SAMPLE(S)	ORIGINAL LOCATION
R185	E HALL - FIRST ROOM - STAIR VENT	X-SEC  2' 3 1/2" (CUT) (STEP END)		P421	RMS 103/203 (STAIRS)
R186	(Reused in 104th NO. 104)	X-SEC  17 1/4" L (CUT) - VERY WEATHERED - SOME WH + FD PAINT		P422	EXT. CORNER BOARD - S WING ?
R187	RM 104 E DOORWAY FRAME - HEADER	OPPOSITE SIDE = PTD RED 2' 8 1/2" L X 5 7/8" W X 1 1/4" T		P423	EXT. CORNER ?
R188	→ Reused as 104th NO. 104 - WH CUT WITH NAILS	 3 3/8" - 3/4" NO PAINT 1" THK - NO PAINT - THIS EDGE (TOTAL CUT = 7 1/2")		P424	EXT. CORNER ?
R189	Part sheathing of KITCHEN ADDITION	X-SEC  8 1/2" W X 2' 7 1/2" L (CUT) X 1 1/8" THK ← PAINT		P425	EXT. Frieze board ?
R190		TELEVISION CABINET (1002) (width cut) x		P426	RM 104/204

SAMPLE(S)	TYPE(S)	ORIGINAL LOCATION
R191	Jamb Piece, similar to R179 but 3 1/4" Long (2 1/4" W x 1 1/4" THK)	RMS 201/202 (N wall closet)
R192	Ditto R191, but 3' 3/4" Long	RMS 201/202 (N wall closet)
R193(a)	RM 204, SE CORNER, SHED block angle brace THIS edge - evidence of elaphevents, ≈ 5 3/4" exposure. Also, latn yr evidence, CUT NAILS - (At head ends, ROUND PRINT, ≈ CLOCK REVOLVING?) (PAINTED WHITE, XI LAYER) [BOTH ENDS CUT] 3 x 1/4" HINGE CUT-OUT (3" H) ca 1903 wood latn with massive evidence 2 1/4" W, 1 1/8" THK 3/4"	EXT-door arch. TRAVE. 2 wings? P431 P432 P433 P434 P435 P436 P437 P438 P439 P440 P441 P442 P443 P444 P445 P446 P447 P448 P449 P450 P451 P452 P453 P454 P455 P456 P457 P458 P459 P460 P461 P462 P463 P464 P465 P466 P467 P468 P469 P470 P471 P472 P473 P474 P475 P476 P477 P478 P479 P480 P481 P482 P483 P484 P485 P486 P487 P488 P489 P490 P491 P492 P493 P494 P495 P496 P497 P498 P499 P500 P501 P502 P503 P504 P505 P506 P507 P508 P509 P510 P511 P512 P513 P514 P515 P516 P517 P518 P519 P520 P521 P522 P523 P524 P525 P526 P527 P528 P529 P530 P531 P532 P533 P534 P535 P536 P537 P538 P539 P540 P541 P542 P543 P544 P545 P546 P547 P548 P549 P550 P551 P552 P553 P554 P555 P556 P557 P558 P559 P560 P561 P562 P563 P564 P565 P566 P567 P568 P569 P570 P571 P572 P573 P574 P575 P576 P577 P578 P579 P580 P581 P582 P583 P584 P585 P586 P587 P588 P589 P590 P591 P592 P593 P594 P595 P596 P597 P598 P599 P600 P601 P602 P603 P604 P605 P606 P607 P608 P609 P610 P611 P612 P613 P614 P615 P616 P617 P618 P619 P620 P621 P622 P623 P624 P625 P626 P627 P628 P629 P630 P631 P632 P633 P634 P635 P636 P637 P638 P639 P640 P641 P642 P643 P644 P645 P646 P647 P648 P649 P650 P651 P652 P653 P654 P655 P656 P657 P658 P659 P660 P661 P662 P663 P664 P665 P666 P667 P668 P669 P670 P671 P672 P673 P674 P675 P676 P677 P678 P679 P680 P681 P682 P683 P684 P685 P686 P687 P688 P689 P690 P691 P692 P693 P694 P695 P696 P697 P698 P699 P700 P701 P702 P703 P704 P705 P706 P707 P708 P709 P710 P711 P712 P713 P714 P715 P716 P717 P718 P719 P720 P721 P722 P723 P724 P725 P726 P727 P728 P729 P730 P731 P732 P733 P734 P735 P736 P737 P738 P739 P740 P741 P742 P743 P744 P745 P746 P747 P748 P749 P750 P751 P752 P753 P754 P755 P756 P757 P758 P759 P760 P761 P762 P763 P764 P765 P766 P767 P768 P769 P770 P771 P772 P773 P774 P775 P776 P777 P778 P779 P780 P781 P782 P783 P784 P785 P786 P787 P788 P789 P790 P791 P792 P793 P794 P795 P796 P797 P798 P799 P800 P801 P802 P803 P804 P805 P806 P807 P808 P809 P810 P811 P812 P813 P814 P815 P816 P817 P818 P819 P820 P821 P822 P823 P824 P825 P826 P827 P828 P829 P830 P831 P832 P833 P834 P835 P836 P837 P838 P839 P840 P841 P842 P843 P844 P845 P846 P847 P848 P849 P850 P851 P852 P853 P854 P855 P856 P857 P858 P859 P860 P861 P862 P863 P864 P865 P866 P867 P868 P869 P870 P871 P872 P873 P874 P875 P876 P877 P878 P879 P880 P881 P882 P883 P884 P885 P886 P887 P888 P889 P890 P891 P892 P893 P894 P895 P896 P897 P898 P899 P900 P901 P902 P903 P904 P905 P906 P907 P908 P909 P910 P911 P912 P913 P914 P915 P916 P917 P918 P919 P920 P921 P922 P923 P924 P925 P926 P927 P928 P929 P930 P931 P932 P933 P934 P935 P936 P937 P938 P939 P940 P941 P942 P943 P944 P945 P946 P947 P948 P949 P950 P951 P952 P953 P954 P955 P956 P957 P958 P959 P960 P961 P962 P963 P964 P965 P966 P967 P968 P969 P970 P971 P972 P973 P974 P975 P976 P977 P978 P979 P980 P981 P982 P983 P984 P985 P986 P987 P988 P989 P990 P991 P992 P993 P994 P995 P996 P997 P998 P999 P1000
R193(b)	Ditto R193, but 1' 10 3/8" Long, + bottom not cut (also reused as latn NAILED x 2)	

NOTE: 191 & 192 go together to make 1 continuous piece.

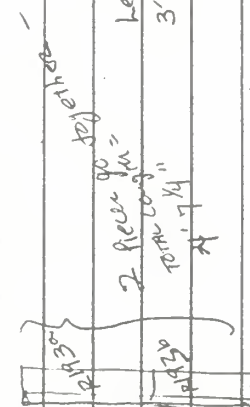
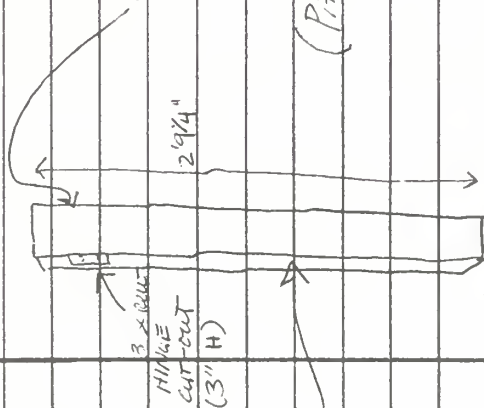

WORI 01 REUSED PAINTED WOODWORK

CATALOG NUMBER	REUSE LOCATION	WOODWORK DESCRIPTION	NAIL TYPE(S)	PAINT SAMPLE(S)	ORIGINAL LOCATION
R194	ATTACHED TO 2ND FLOOR HALL WINDOW SUMP, NORTH SIDE Board in SPUR IN WINDOW	<p>NO PAINT ON EDGE - ONLY NAIL HOLES ONLY</p> <p>2'9 3/4"</p> <p>SHADOW - NO PAINT 3" W</p> <p>1 1/2"</p> <p>1 3/16" THICK</p>	THIS END NOT CUT	P433	GREEN RANGE STAIRS RMS 103/203
R195	1"5. width W SIDE, WINDOW header over porch"	<p>2'11 1/4" L X</p> <p>2 3/16" W X</p> <p>7/8" THK</p> <p>level</p> <p>Header, 3" L, 3 screws w/ flat points</p> <p>Door ARCHIT.</p>	(None)	P444	Rm 202 (S WALL)
R196	Rm 101 W wall, nailed to ceiling. stud in doorway enclosed ca. 1980	<p>3 5/4 1/2 (cut) x 2" wide (cut), 7/8" thk</p> <p>RT SIDE ALTERNATIVE</p> <p>baseboard cutline</p> <p>NO PAINT</p> <p>THIS edge ripped</p>		P445	Rm 101, W wall door

APPENDIX G. "HOME LIFE" LYCEUM SPEECH

The following are excerpts from "Home Life," a lyceum speech written by Elizabeth Cady Stanton circa 1880. The text of this speech is in the collection of the Douglas College Library at Rutgers University. No descriptions of the house in Seneca Falls are included, but the speech is still an interesting record of Elizabeth Cady Stanton's views on how the ideal household should be designed and organized. One cannot speculate that her Seneca Falls house had all or even most of the items she recommended in her later speech. For example, she advocates stained woodwork and refrigerated storage, but her Seneca Falls house had neither. However, the speech can serve as evidence to corroborate theories suggested by the physical evidence.

The excerpts have been sorted by subject matter for ease of reference. Page numbers refer to a transcription on file at Women's Rights NHP.

Site

"Build your house on a hill, not that you may be seen of all men, but to avoid the malaria of low ground, and to secure good drainage." (p. 3)

"[It is important to have]...nice green sod round the house." (p. 4)

"Keep your grounds be they large or small neat, let everything round the back door be as clean as the front." (p. 6)

"[It is the woman's responsibility]...that garden and lawn are attended to, lawn mower roller carts and carriages [being stored] under cover." (p. 11)

Water

"Our cisterns, and wells, independent of our intentions are effective drains. It is estimated that a well sixty feet deep, will drain an area two hundred feet in diameter, and if in that space an escape pipe is broken or any impurity exists the water you drink is contaminated.... If your house is so situated that you cannot get pure well water rain filtered is best for drinking." (p. 4)

"[It is the woman's responsibility]...that water pipes and waste pipes are fairly dealt with...." (p. 11)

Cellar

"Cellars should not be filled with decaying vegetables but kept clean and dry, windows open constantly in the summer, and as often as the weather will allow in winter." (p. 4)

Rooms in General

“My advice to young people just about to start in life would be this build your house for your own use. If the wife must do her own work, make the sunny side of the house into a large airy kitchen, and dining room and put the parlor sitting room and library all in one for family use.” (p. 5)

Kitchen

“The [important] conveniences of life [include]...a kitchen range with all the modern improvements...a good refrigerator, wire safe....” (p. 4)

“Those who can afford the room should have two kitchens, one for washing, and ironing.” (p. 5)

“[It is a woman’s responsibility]...to keep the range with its pipes, bricks, grates and dampers, in good working order, to select the right kind of coal, provide abundance of kindling, and see that the supplies for the table never give out....” (p. 11)

“[It is important to have]...a kitchen supplied with conveniences, well cooked food, a light cheerful dining room, the table tastefully arranged, always with flowers in the center if possible....” (p. 21)

Dining Room

“The [important] conveniences of life [include]...a large airy dining room....” (p. 4)

Parlor

“As to the parlor, I have little patience to speak of a room, on the pleasantest corner of the house, usually closed, kept dark and damp in which to receive your visitors, into which Father, children seldom enter, the room which has the best carpet, the best furniture, the best pictures, the best everything and yet is musty for want of use. If any of you have such a parlor I implore you to throw it wide open windows and doors and enjoy it while you may.” (p. 5)

Bedrooms

“The eternal fitness of things is ever lost sight of....Bedrooms with no convenient place to put a bed....” (p. 4)

Doorways and Windows

“The eternal fitness of things is ever lost sight of....doors swing so as to take up the most possible room, and to interfere with each other.” (p. 4)

“The [important] conveniences of life [include]...door and window screens....” (p. 4)

“Over every door if possible have a transom, for the door of a room must often be closed and yet it is the only means of thorough ventilation.” (p. 5)

“Windows were intended for light and air, to bring into our homes sunshine and health, and not merely for frames on which to hang heavy curtains. Thin muslin or lace curtains that soften without excluding the light are far prettier than the richest damask.” (p. 6)

Floors

“If you can afford it, have hard wood floors throughout your house, if you cannot have the flooring or narrow boards stained in imitation of oak or black walnut. No matter how clean carpets are kept there is always a dust rising from them which we inhale with every breath. Carpets are more expensive than wood floors, and then to keep them from fading most people shut out the life giving light of the sun.” (p. 5)

Stairway

“The eternal fitness of things is ever lost sight of....stairs narrow and steep like Jacobs ladder....” (p. 4)

Woodwork

“I would advise you to stain rather than paint your woodwork. It is cheaper because it is necessary to do it but once, and seldom needs washing; it is more artistic because it shows the beautiful grain of the wood.” (p. 5)

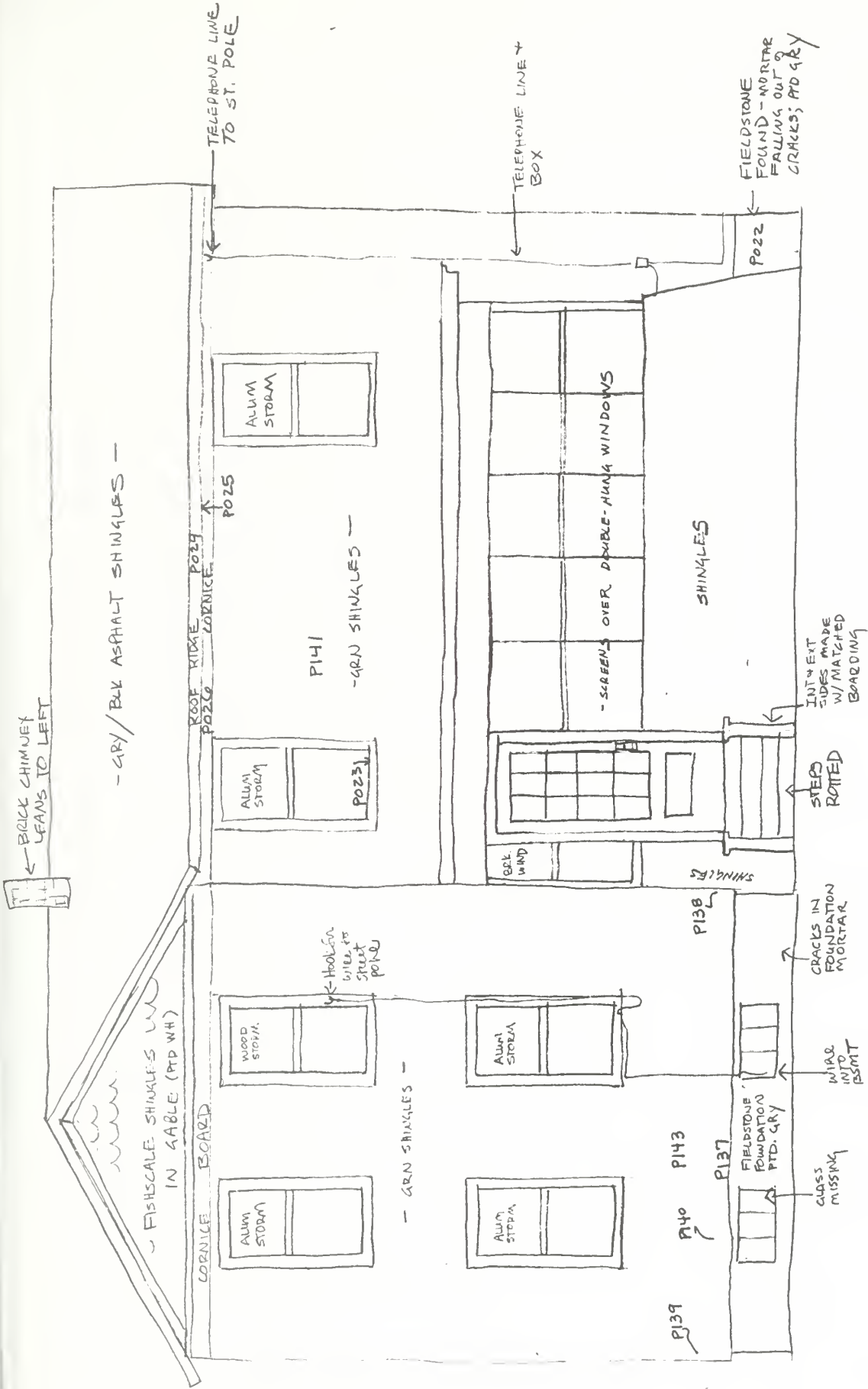

STANTON HOUSE
 WEST FACADE
 7 JUNE 82

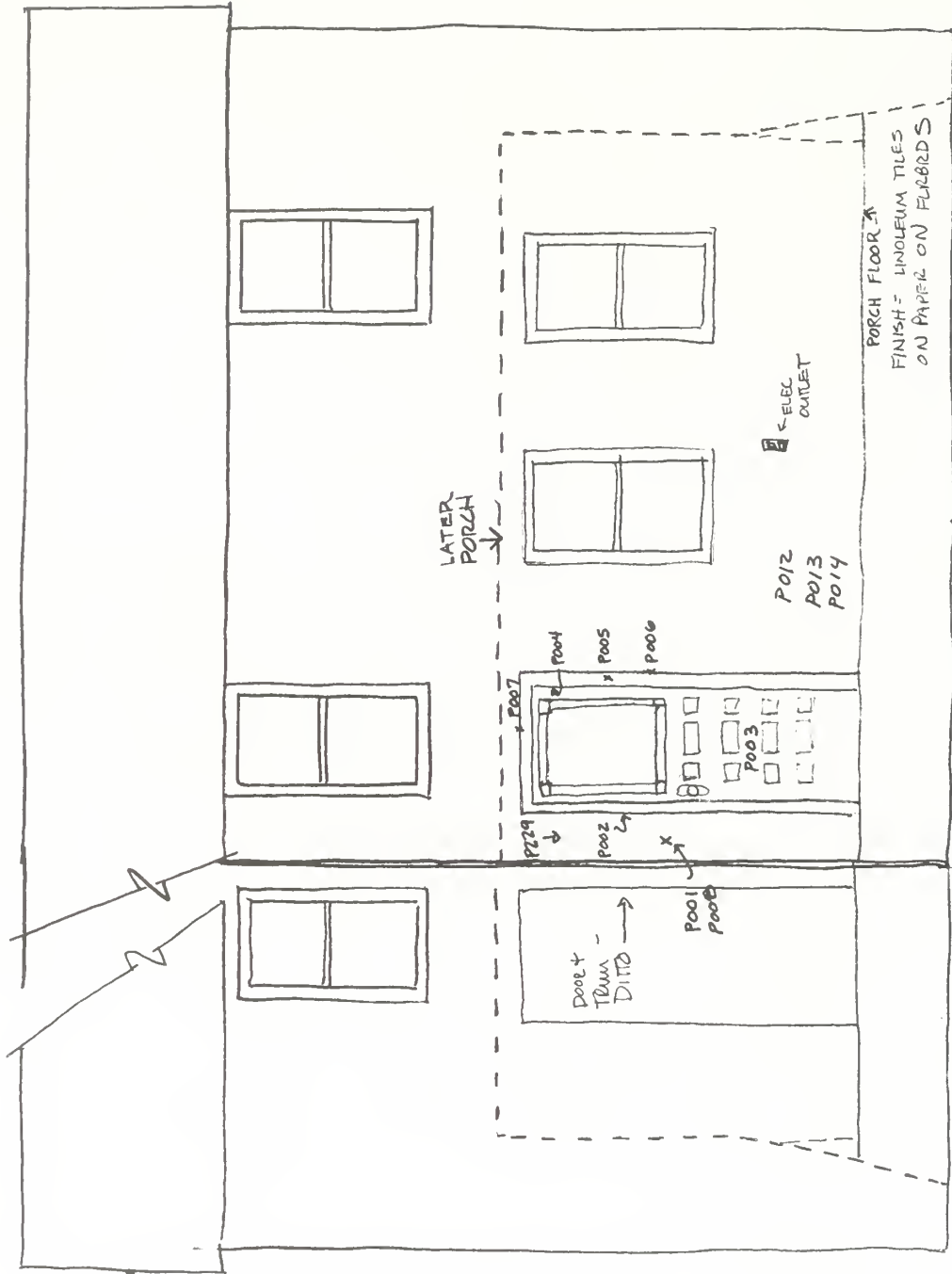

PORCH CEILING
 BEADED BOARDS. Elec. PORCH
 LIGHT IN CEILING
 BEADED BRDS EXT. WALLS
 ABOVE WINDOWS

STANTON HOUSE
 EXT. PORCH (FRONT)

STANTON HOUSE
DETAIL WINDOW
WEST PORCH
10 JUNE 82

EXT
NOTE: DOOR DETAILS IDENTICAL
TO WINDOWS (TOP FLANK TRIM, SIDE
MOLDED TRIM)

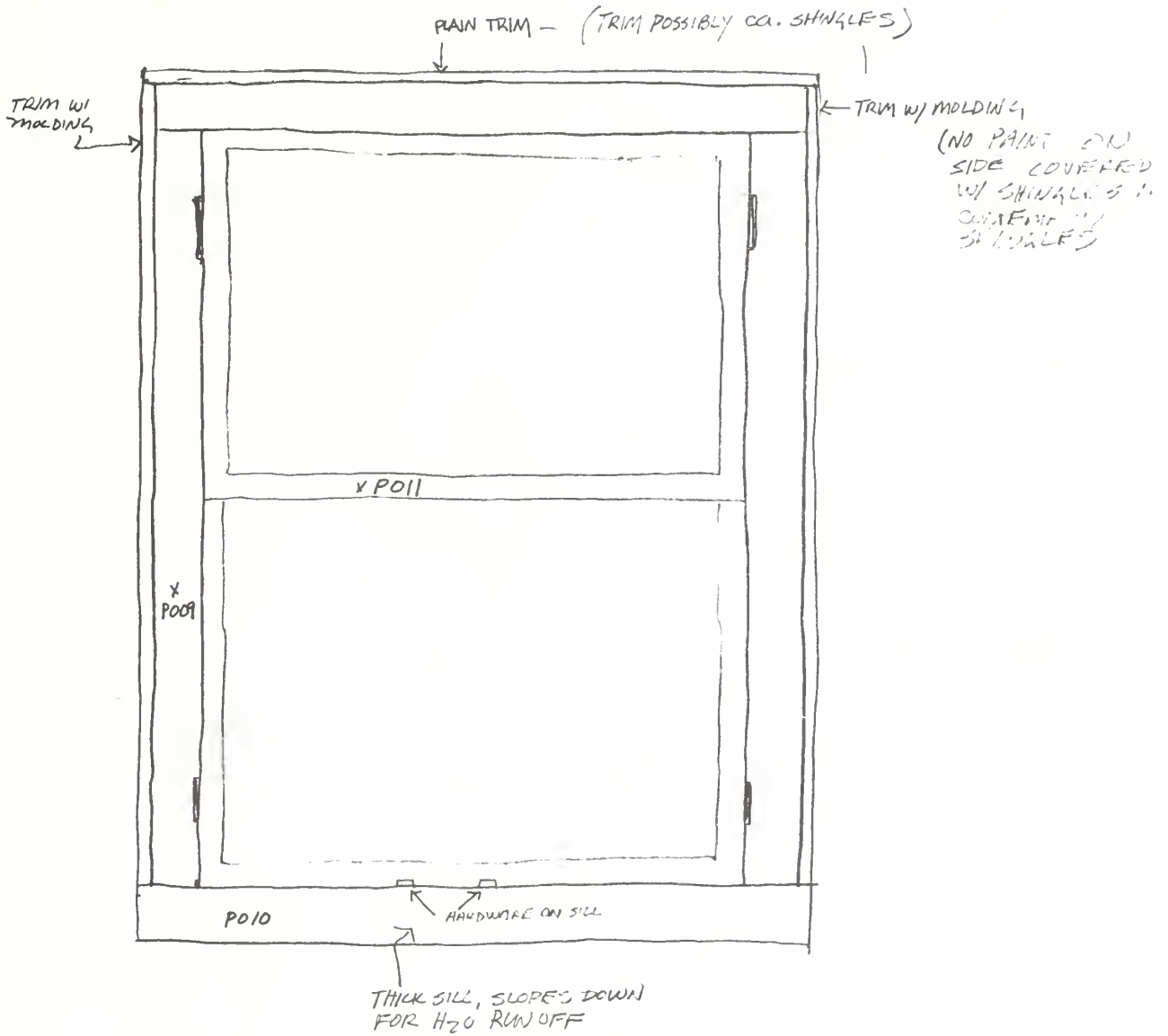

EXT WINDOW STOPS CONTEMP
W/ 3/4 SASH

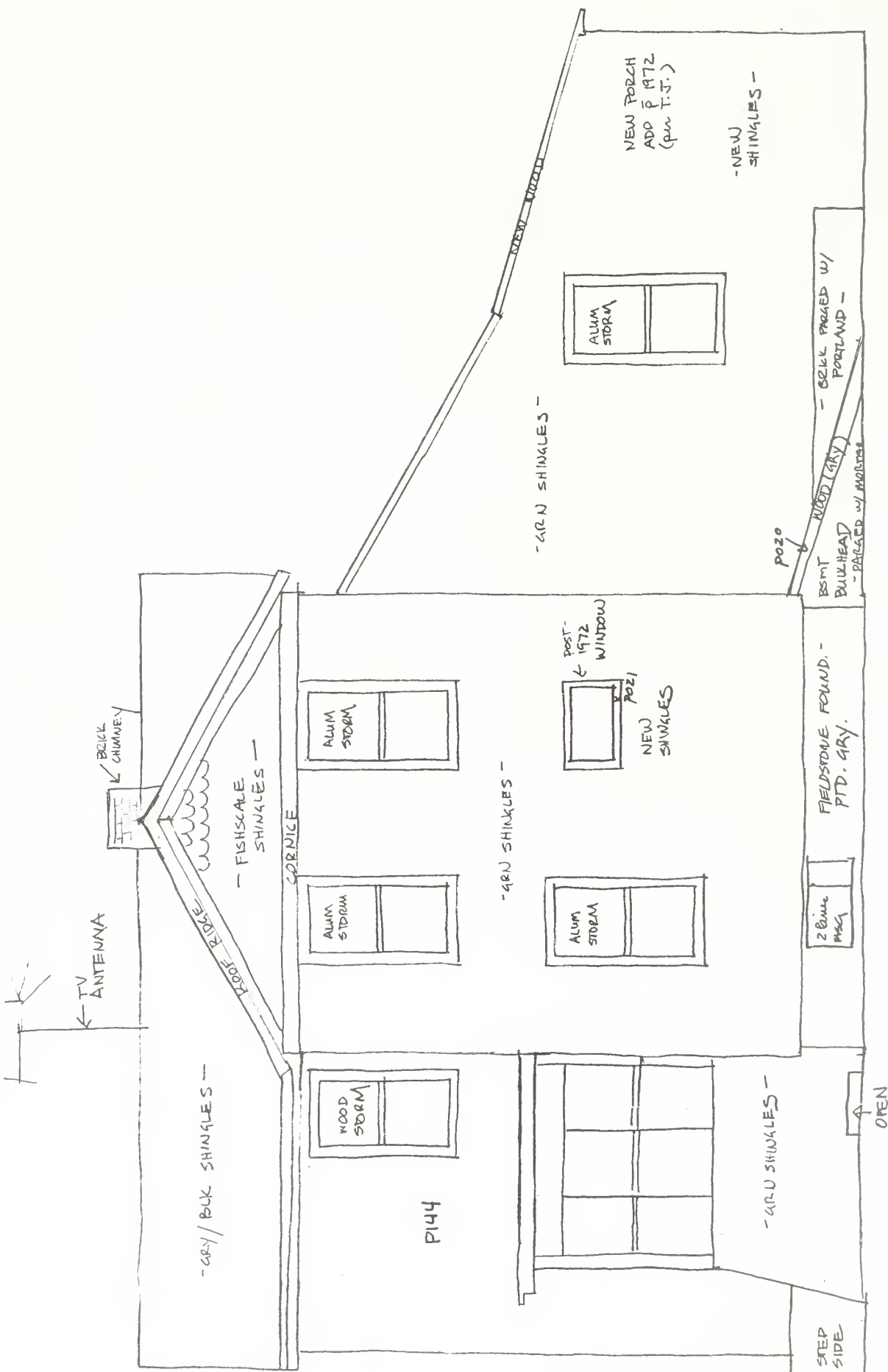

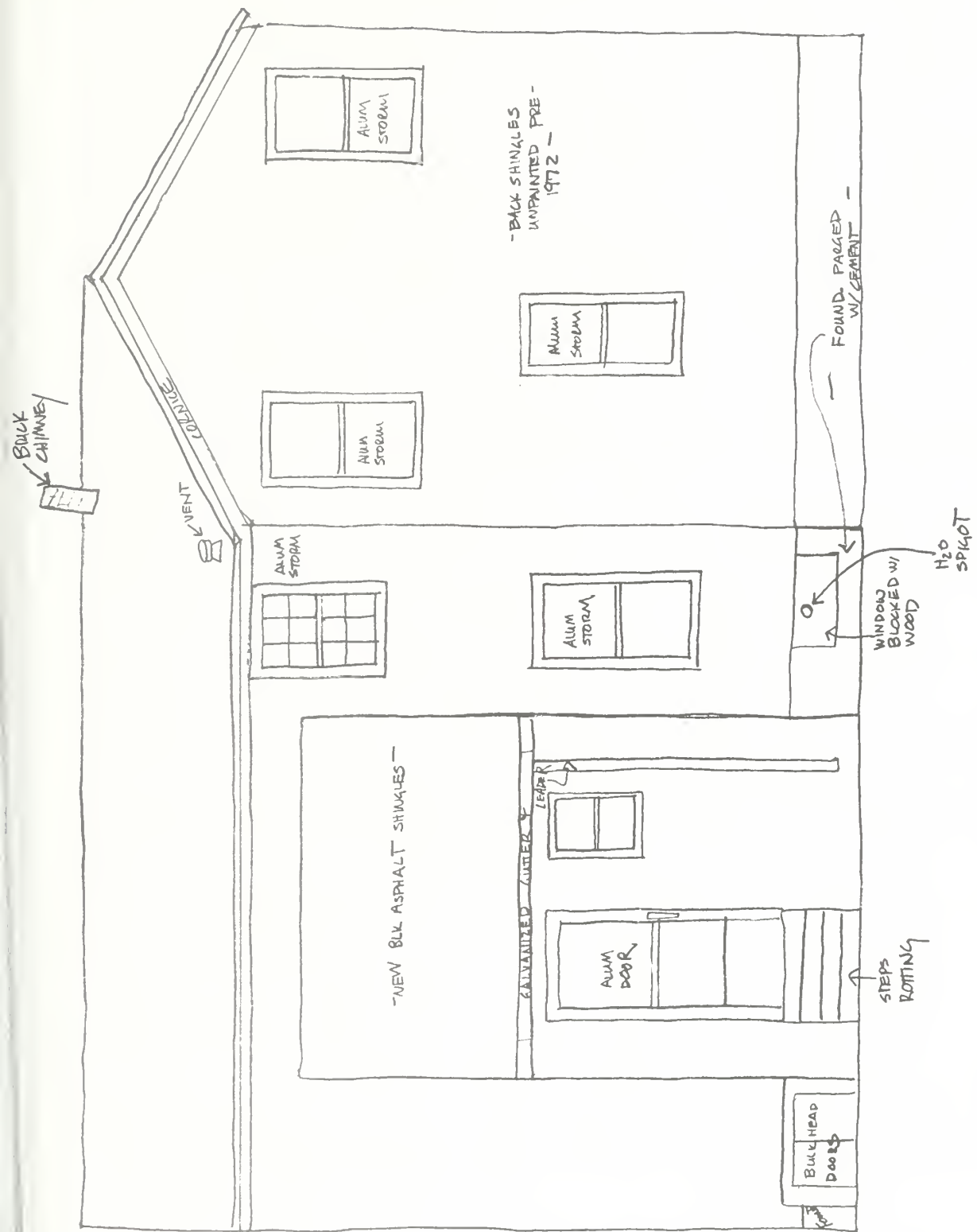

STANTON HOUSE
 EAST FACADE
 7 JUNE 82

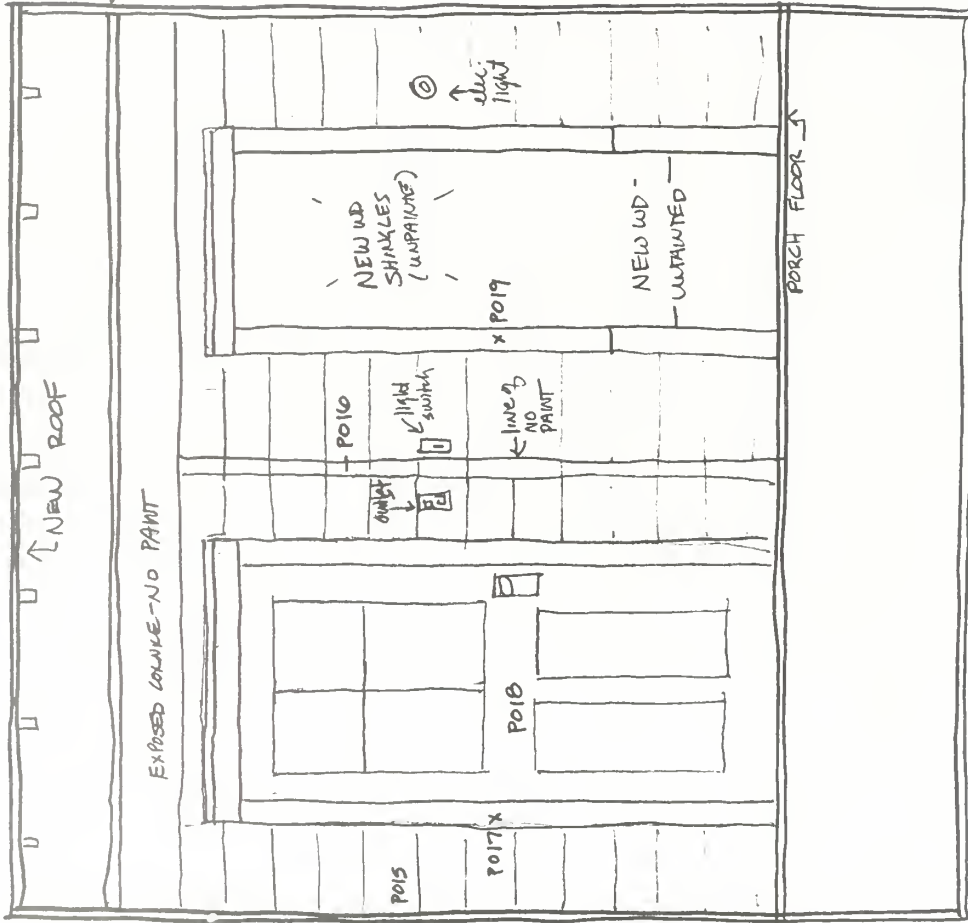

← OLD ROOF - CAN SEE ASPHALT SHINGLES (TOP) + WOOD SHINGLES (BOTTOM)

- New int. work (ext walls) UNPAINTED

NOTE - No vinyl molding, TRIM on door + wind TRIM - JUST TOP MOLDING (PLAIN)

PAINTED CLAPBOARDS

STANTON HOUSE
EAST FACADE - REAR PORCH
8 JUNE 82

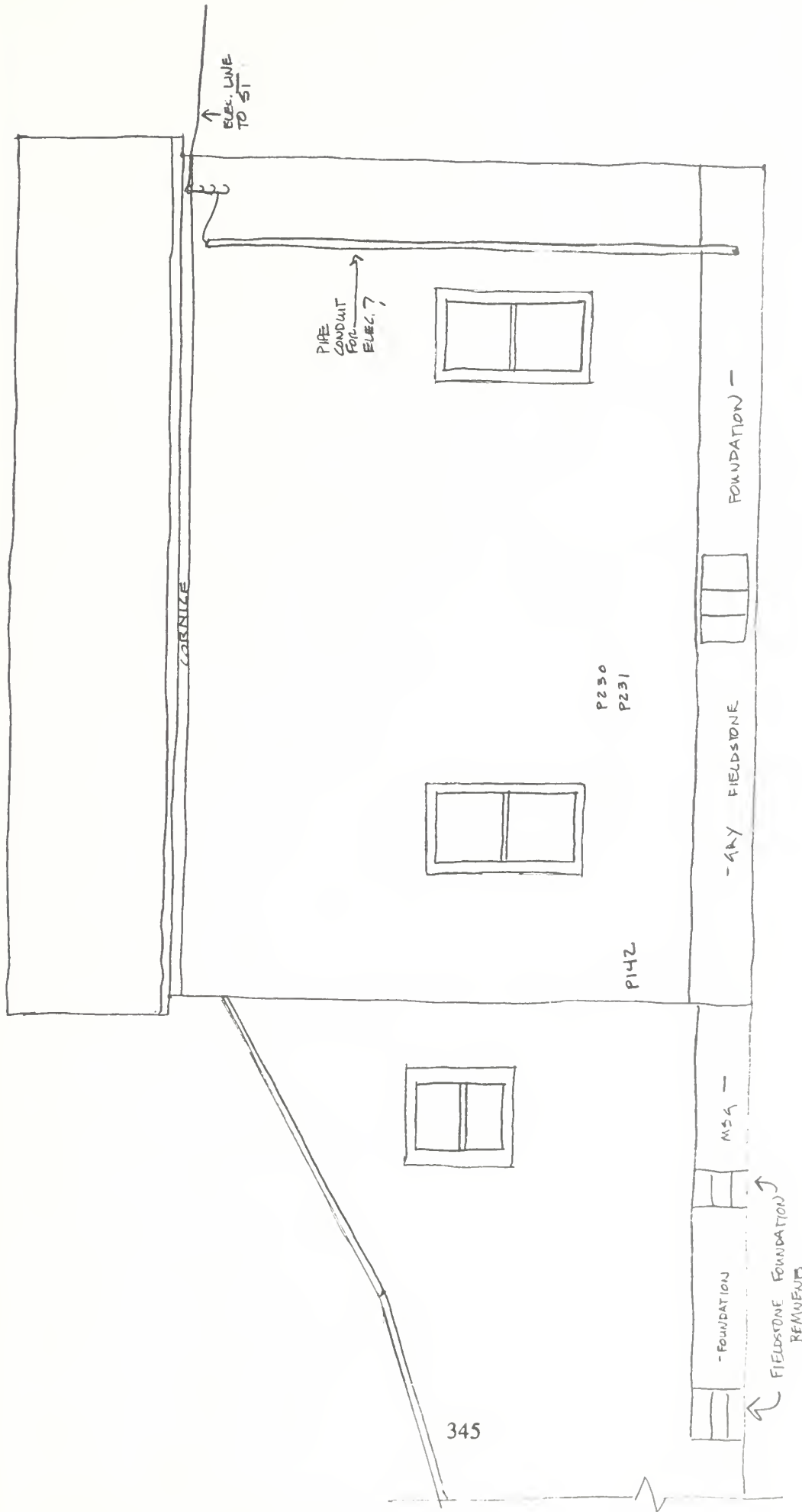

STANTON HOUSE
 NORTH FACADE
 7 JUNE 82

STANTON HOUSE
ROOF PLAN
7 JUNE 82

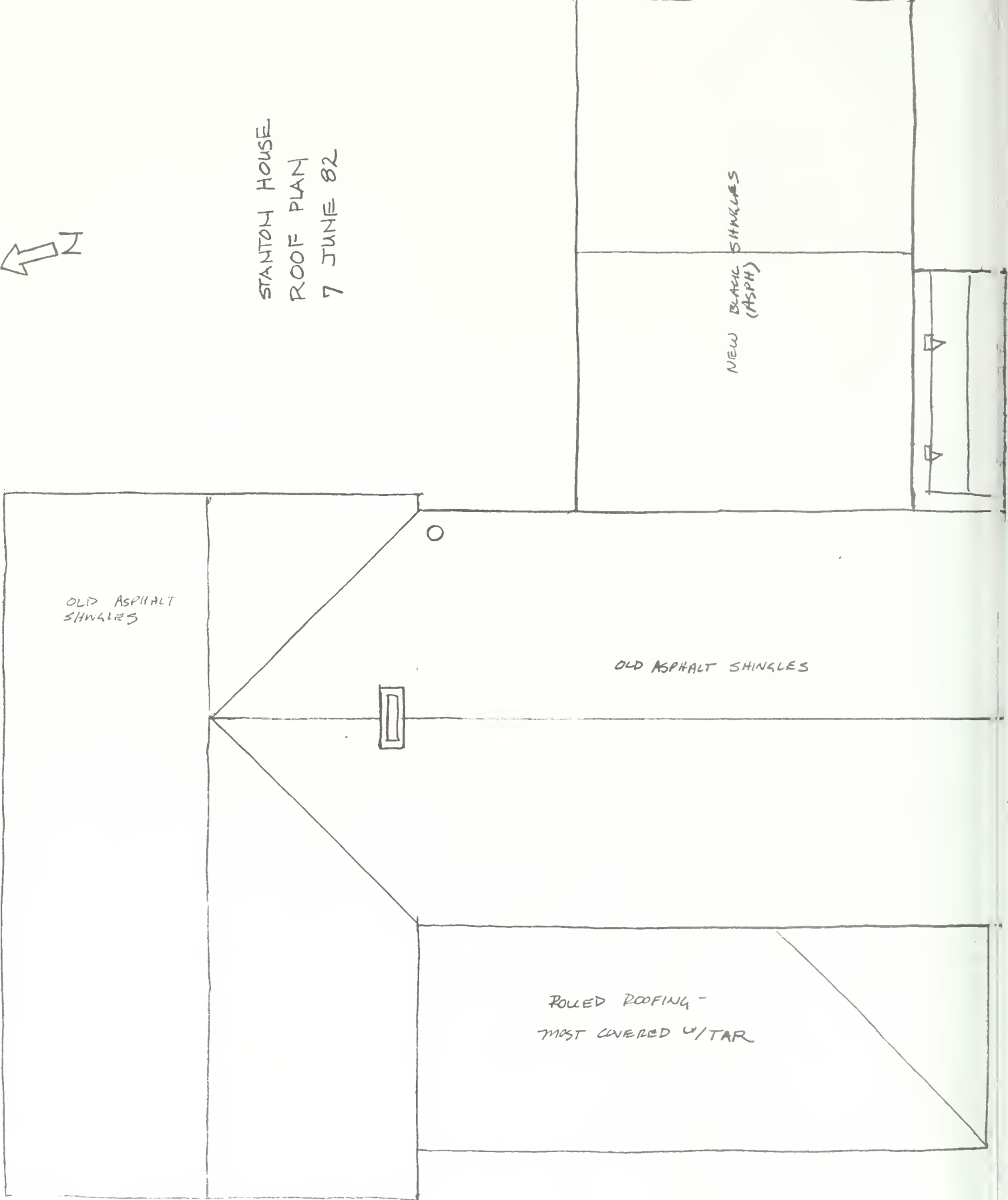

new floor
shells
new floor

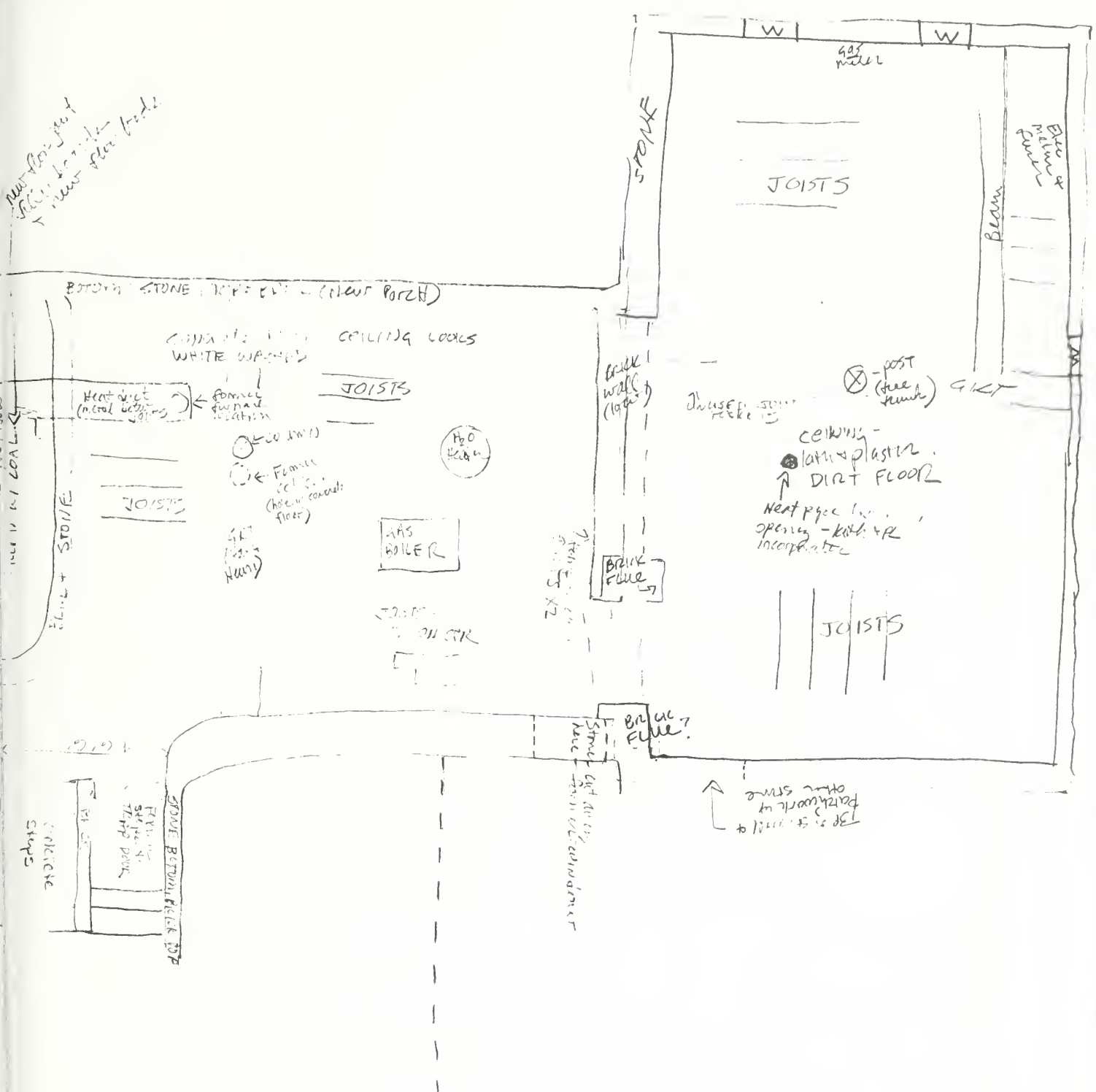

STANTON HOUSE
 BASEMENT
 10 JUNE 82

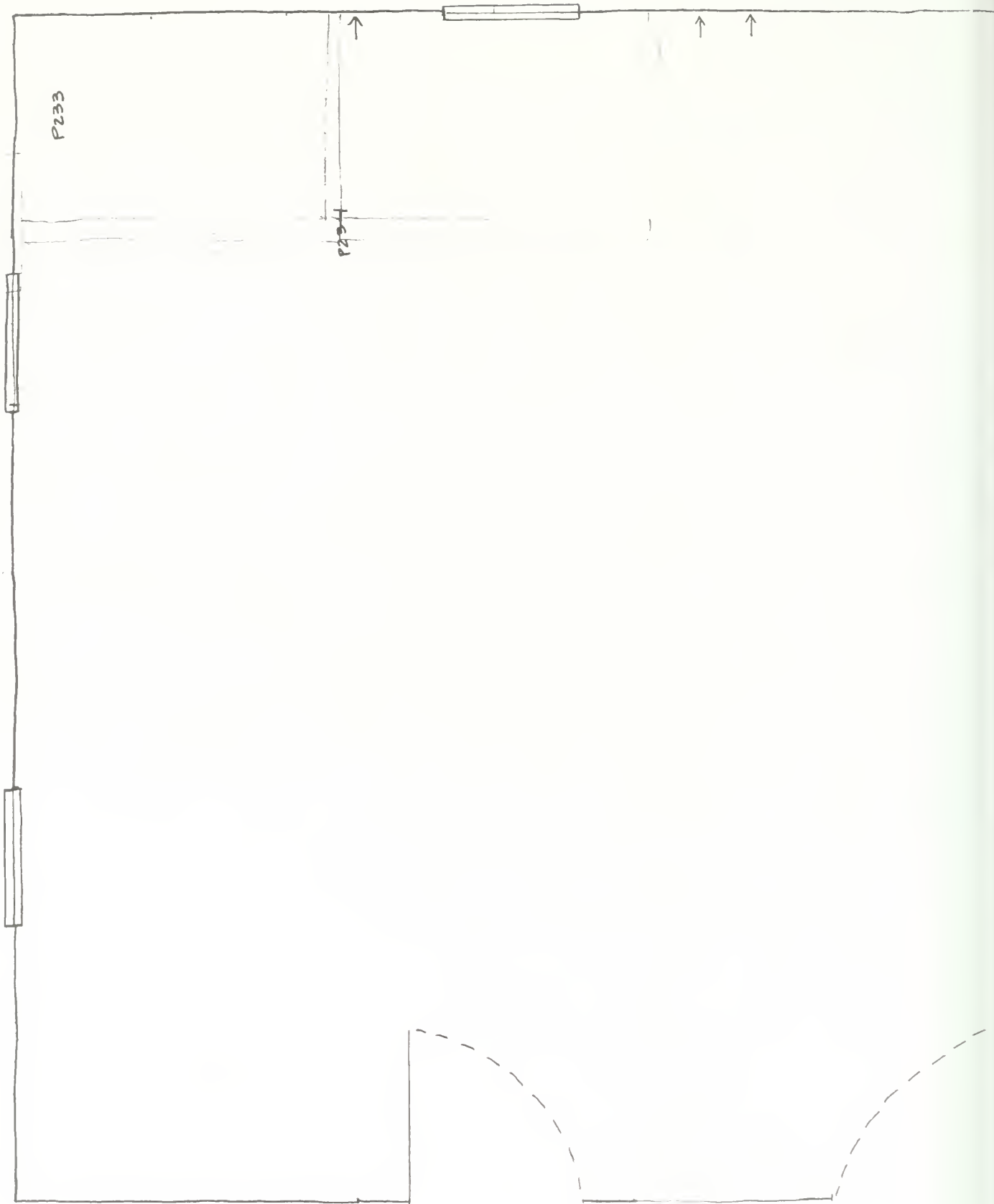

STANTON HOUSE
N WEST RM - 157 FLR
O JUNE 02
RM 101

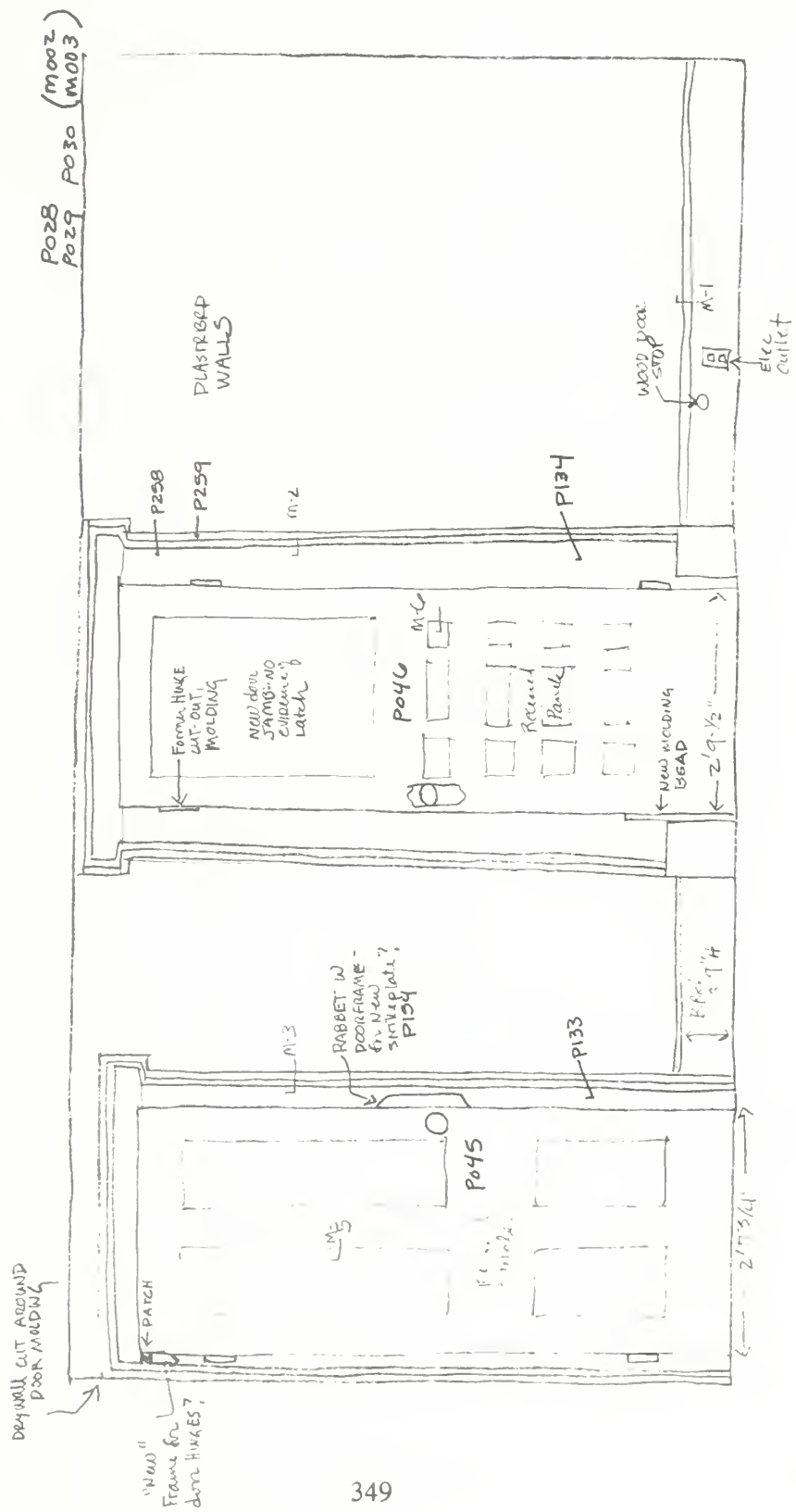

STATION HOUSE
 110, KAY BENT
 SOUTH WALL
 8 JUNE 82
 RM 101

3' 5" x 15' 17 1/2" x 10" 2019 CEILING

- WINDOW OPENINGS 4' 6" H X 2' 3" W

- VENTILATION blind hardware, window casings

- Floor = wall to wall carpet (gym)

- 1" 10.1" 2x4" + 1" 10.1" 2x4" SASH PLUGS FOR OPENING

CEILING JOISTS - 16" ON CTR., RUNNING E-W

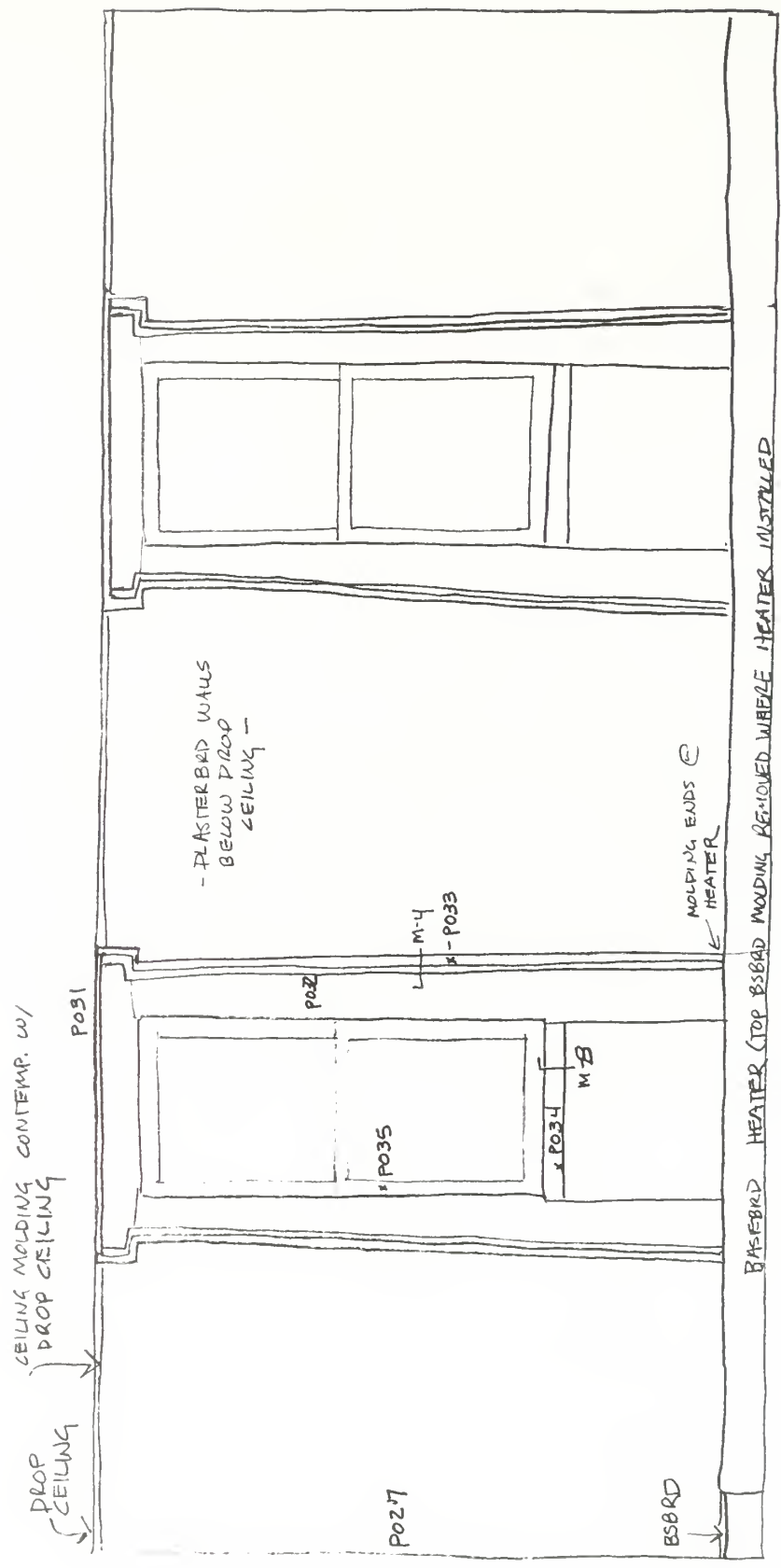

STANTON HOUSE
NW RM - 1st FLR
WEST WALL

RABBIT WIRE &
 CEILING BEHIND
 DRYWALL & DROP
 CEILING

MOOD

PROP CEILING

- PLASTER WALLS -

COMMEM.
PLAQUE

PZZO (BEHIND)

MANTEL

- PLASTER -

CUT IN
BOBBD

CUT IN
BOBBD

ELEC
OUTLET

P040

CUT IN
BOBBD

P037

WOOD
BOBSTOP

~5'11"

~5'9"

~5'11"

~24'

~9'

~24'

352

STANTON HOUSE
 NW RM 1SD FLR
 EAST WALL
 27

JUNE, 1982
RM 102

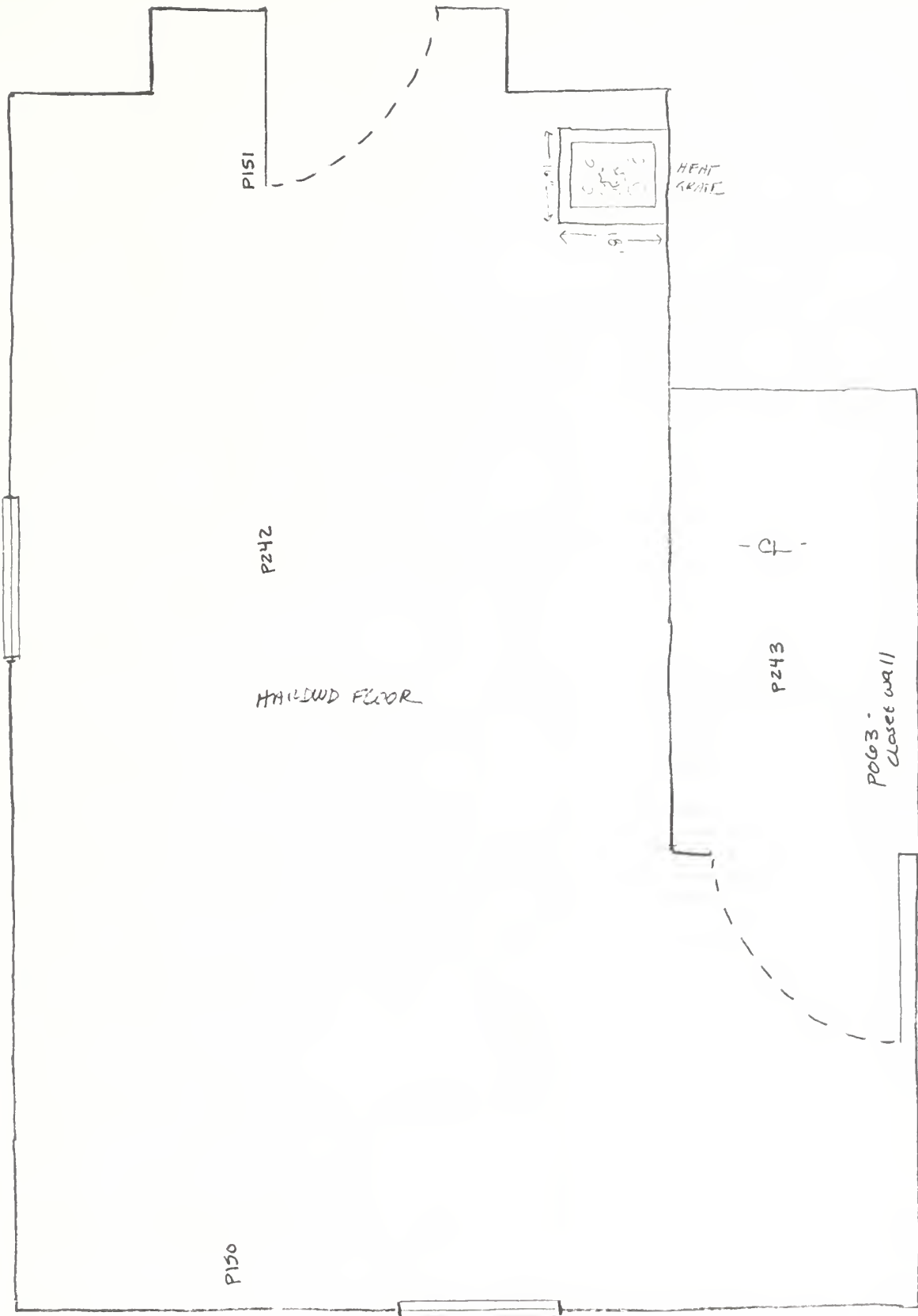

SANTON HOUSE
 NE PLASTER
 & TRIM F.P.
 RM 102

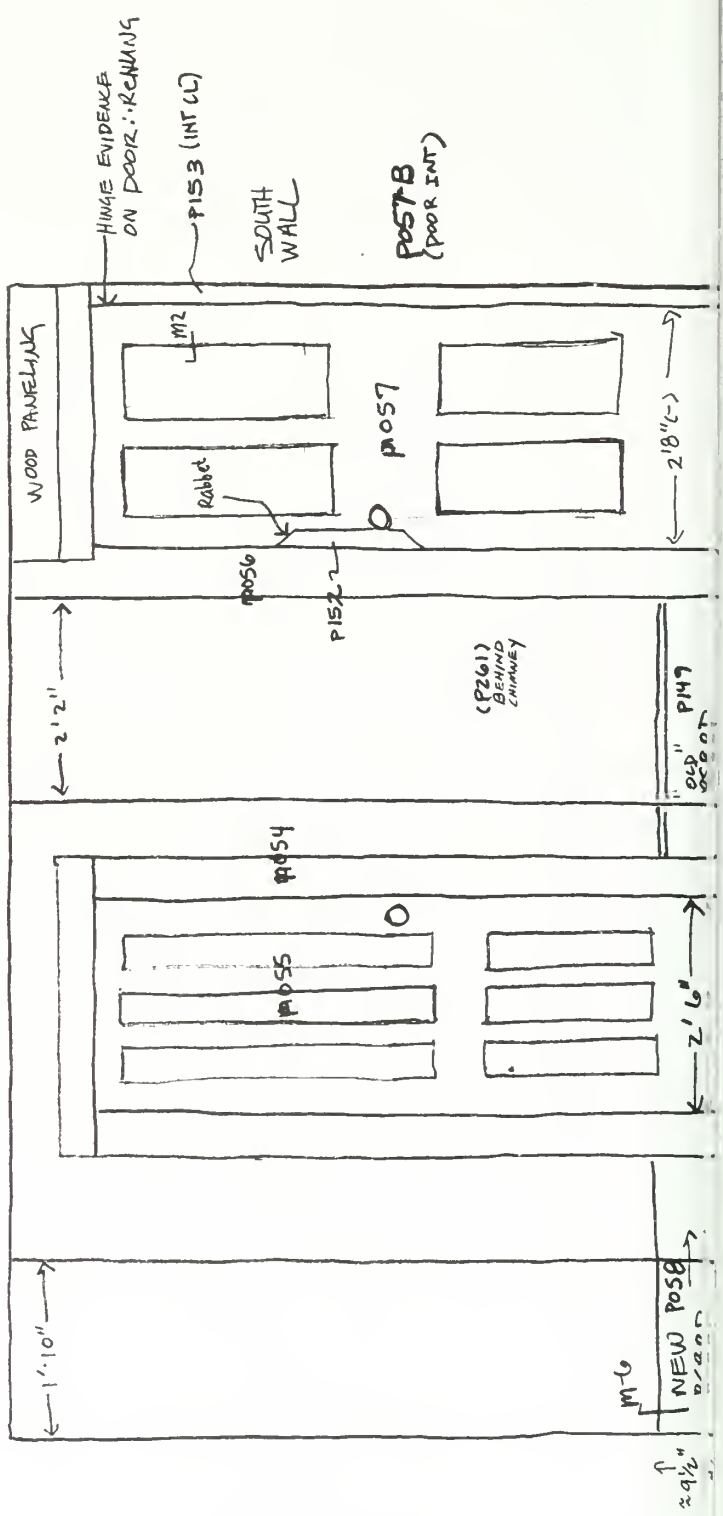
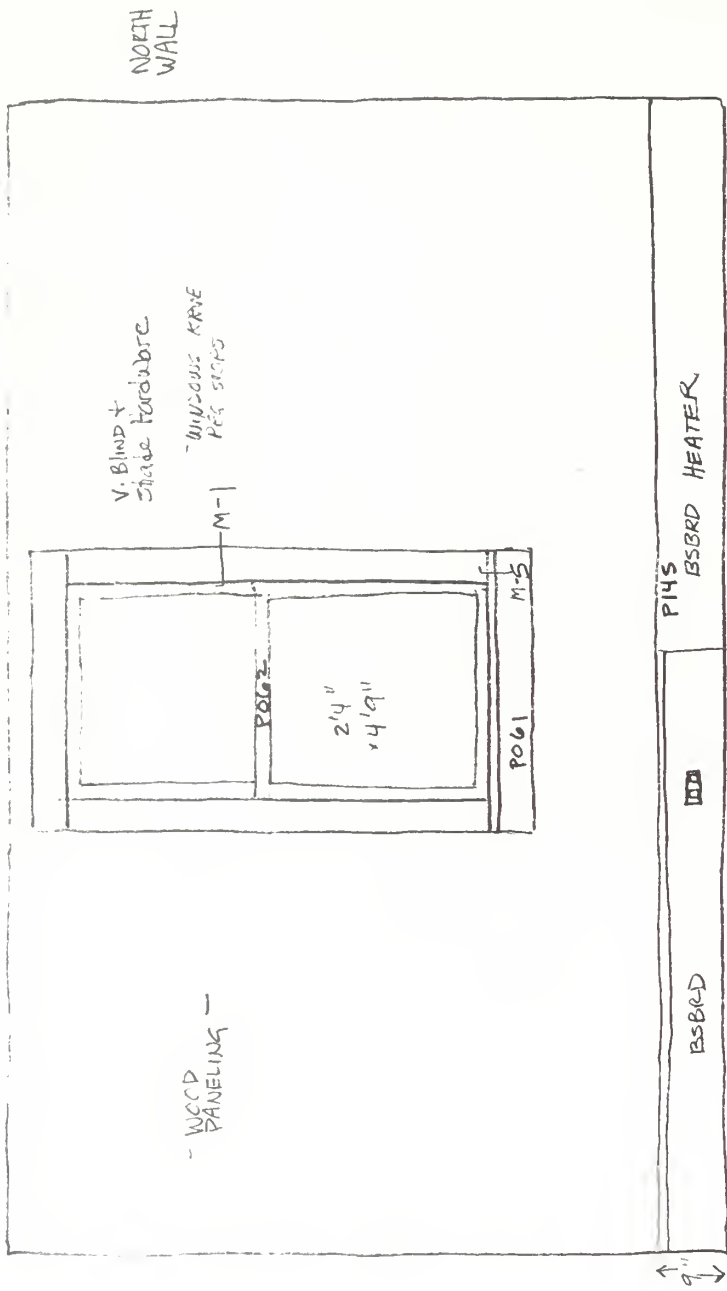

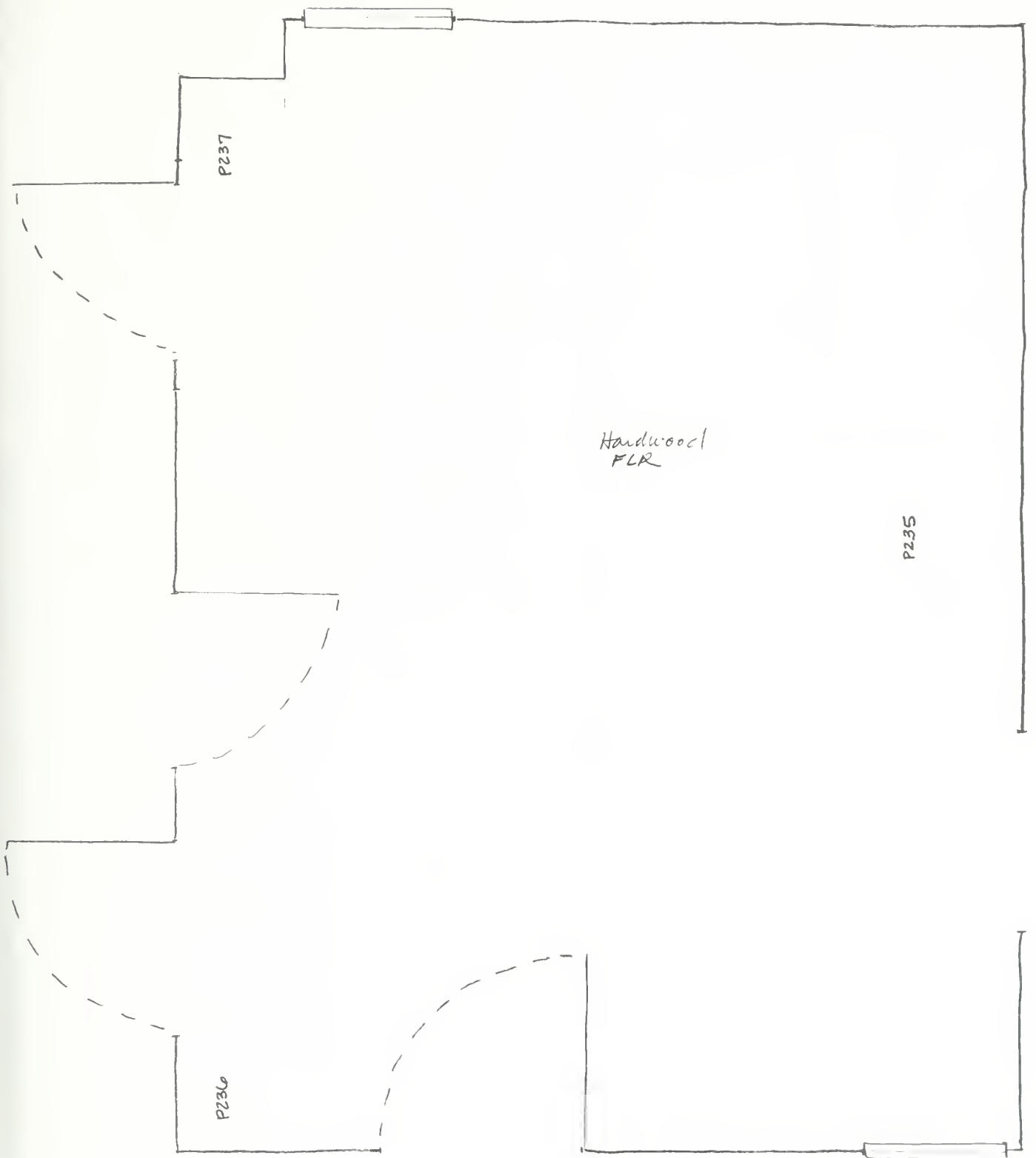

STANTON HOUSE
MID-RM 1⁵³ FLR
8 JUNE 82
RM 103

18'
12'
7'7"

STANTON HOUSE
NE RM-107R
8 JUNE 82
RM 102

WEST WALL

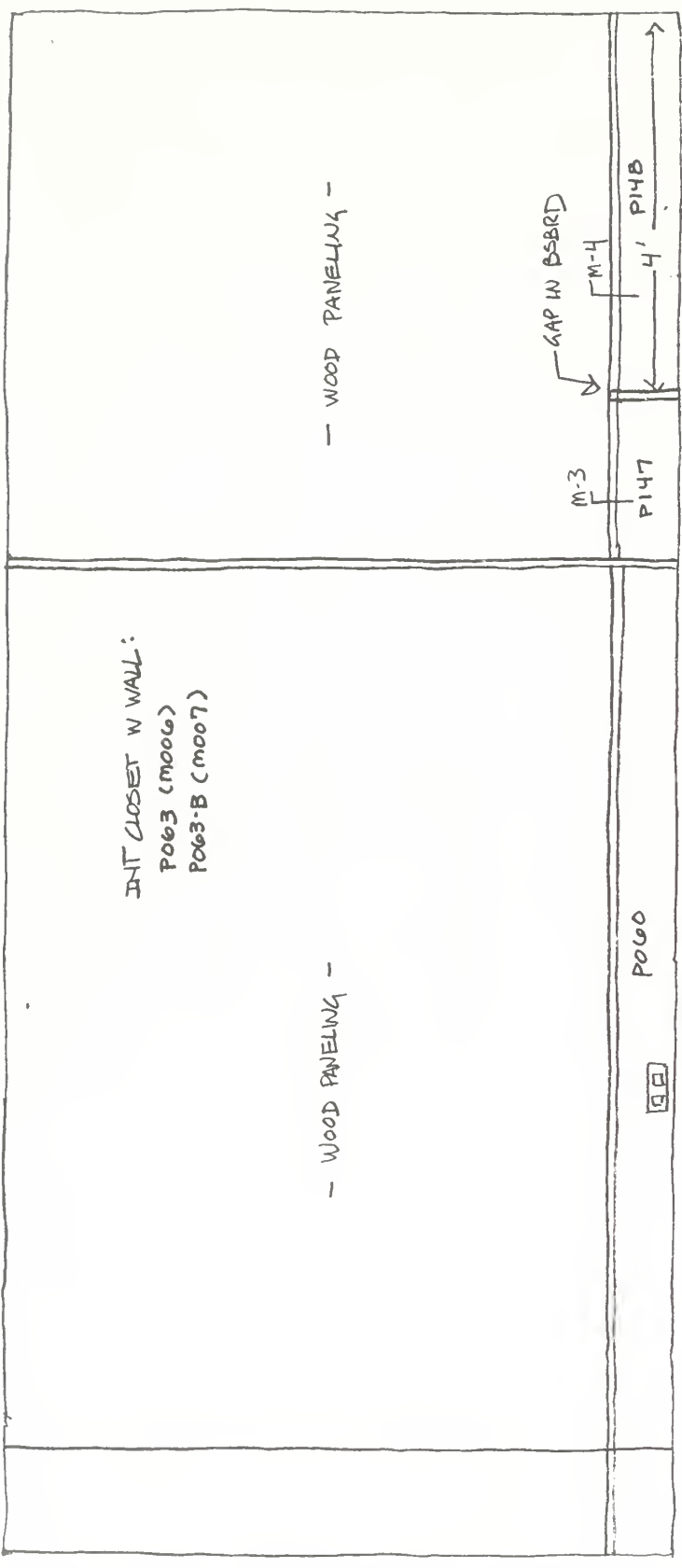

356

EAST WALL

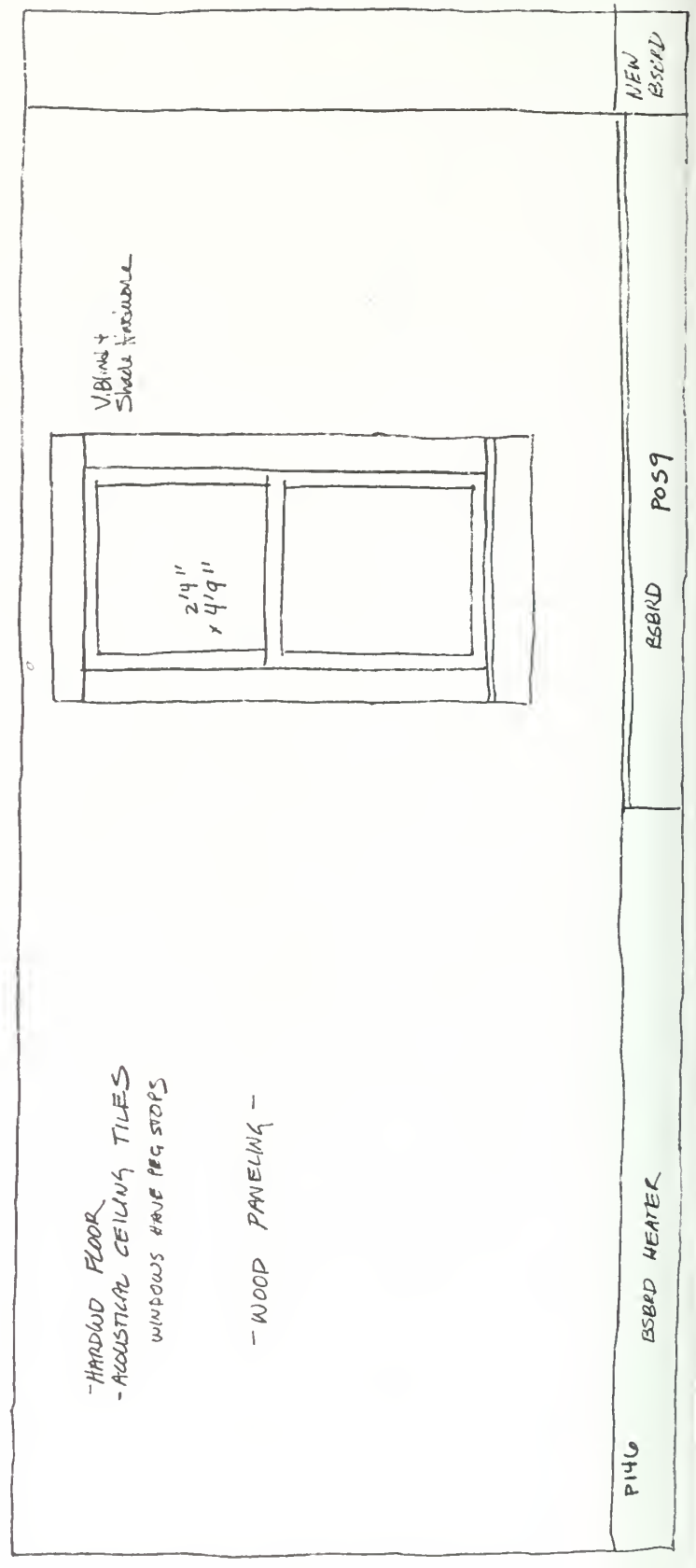

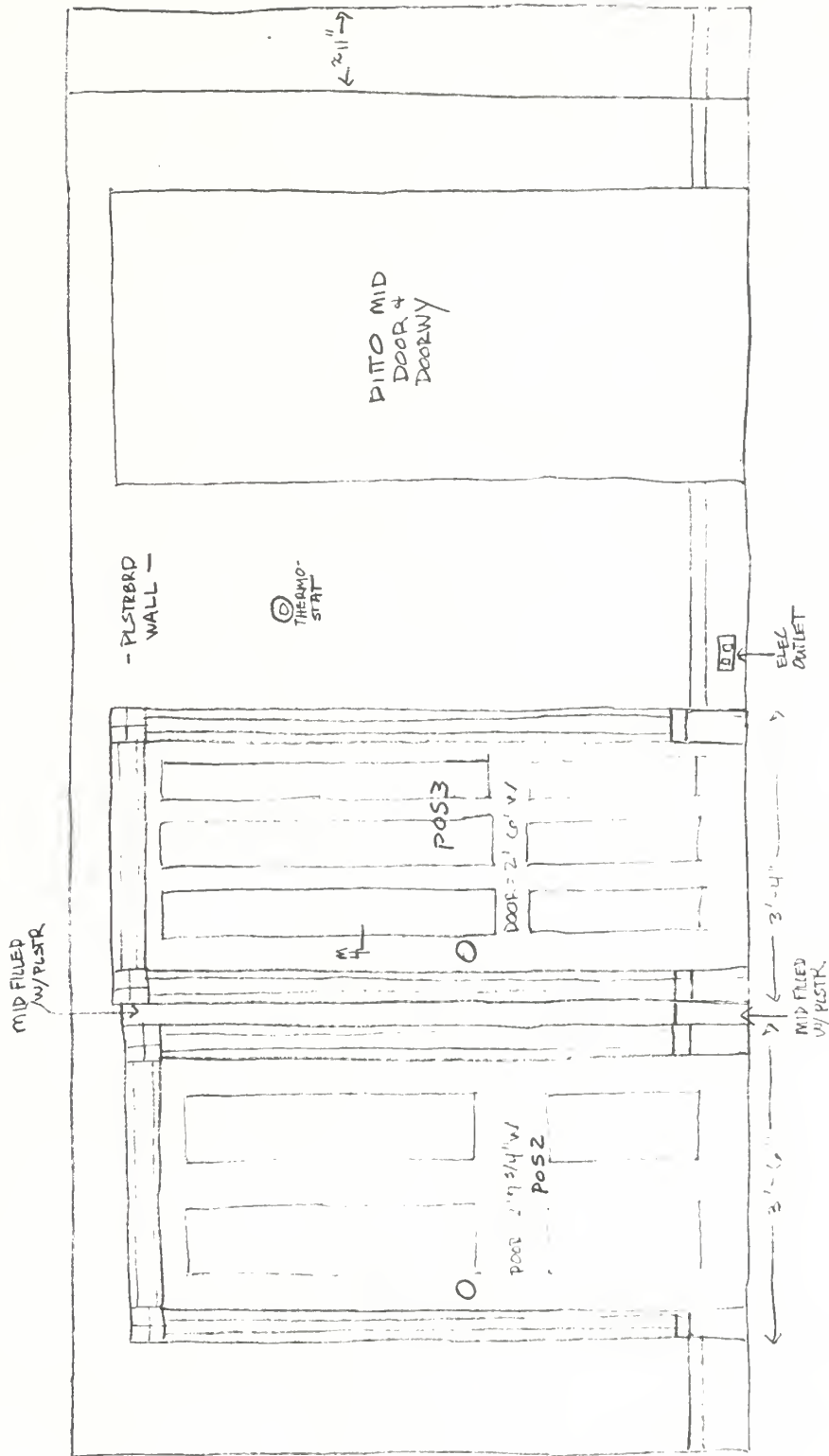

STAIRCASE HOUSE
 MID RM - 1st FLR
 NORTH WALL
 F. JULIE BZ
 RM 103

STANTON HOUSE
 MID RM - 1st FLR
 Rm 103

EAST WALL

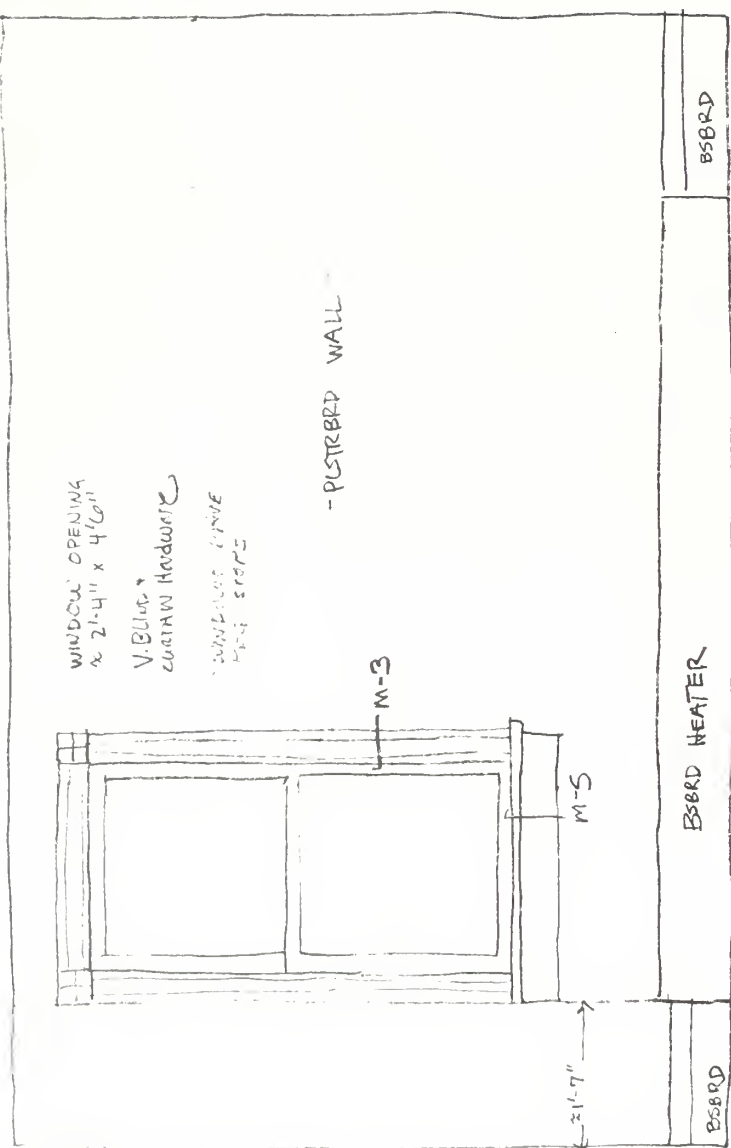

WEST WALL

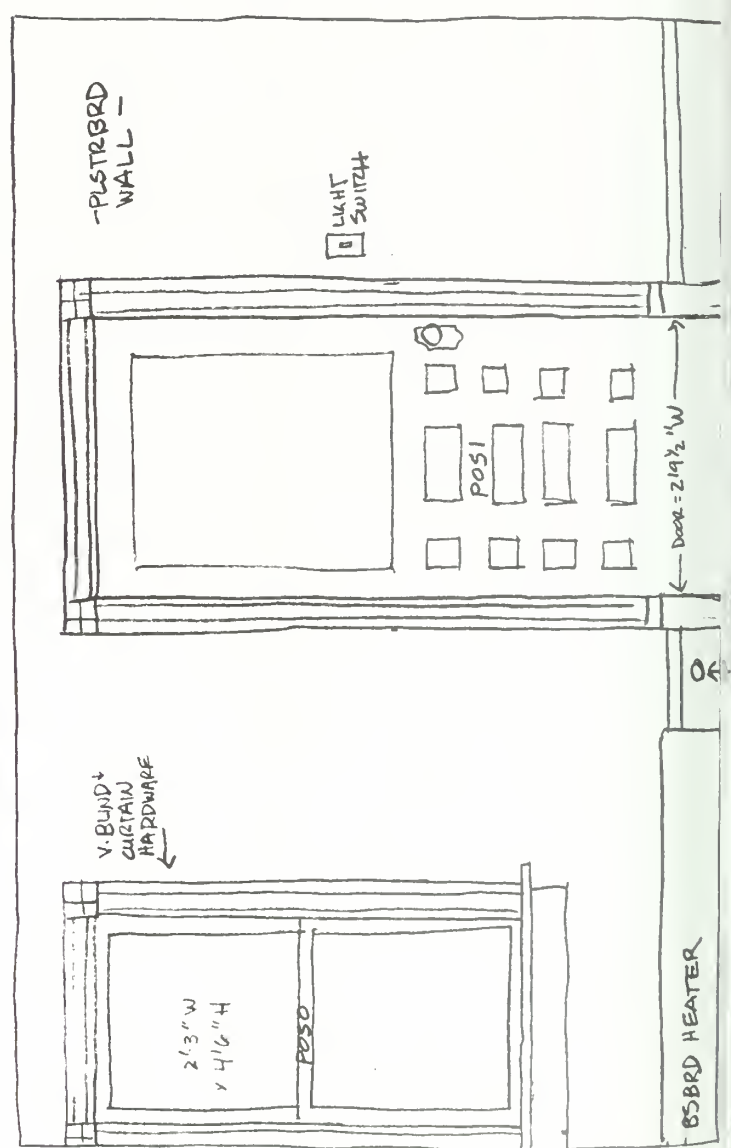

X
 →
 (BEHIND WALL)
 (BEHIND WALL)

16' x 11'8" x 7'7" H

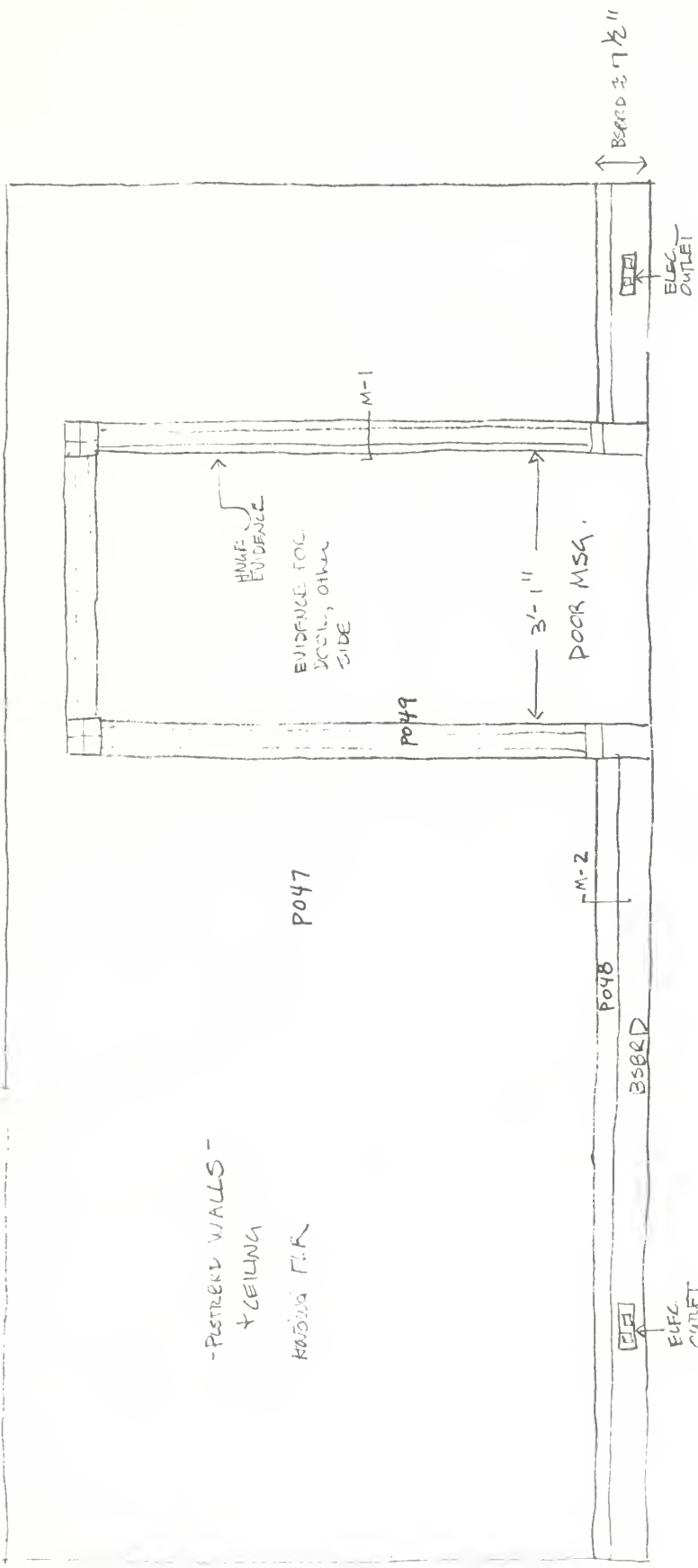

STANTON HOUSE
 MID-RM, 135FLR
 SOUTH WALL
 8 JUNE 82
 RM 103

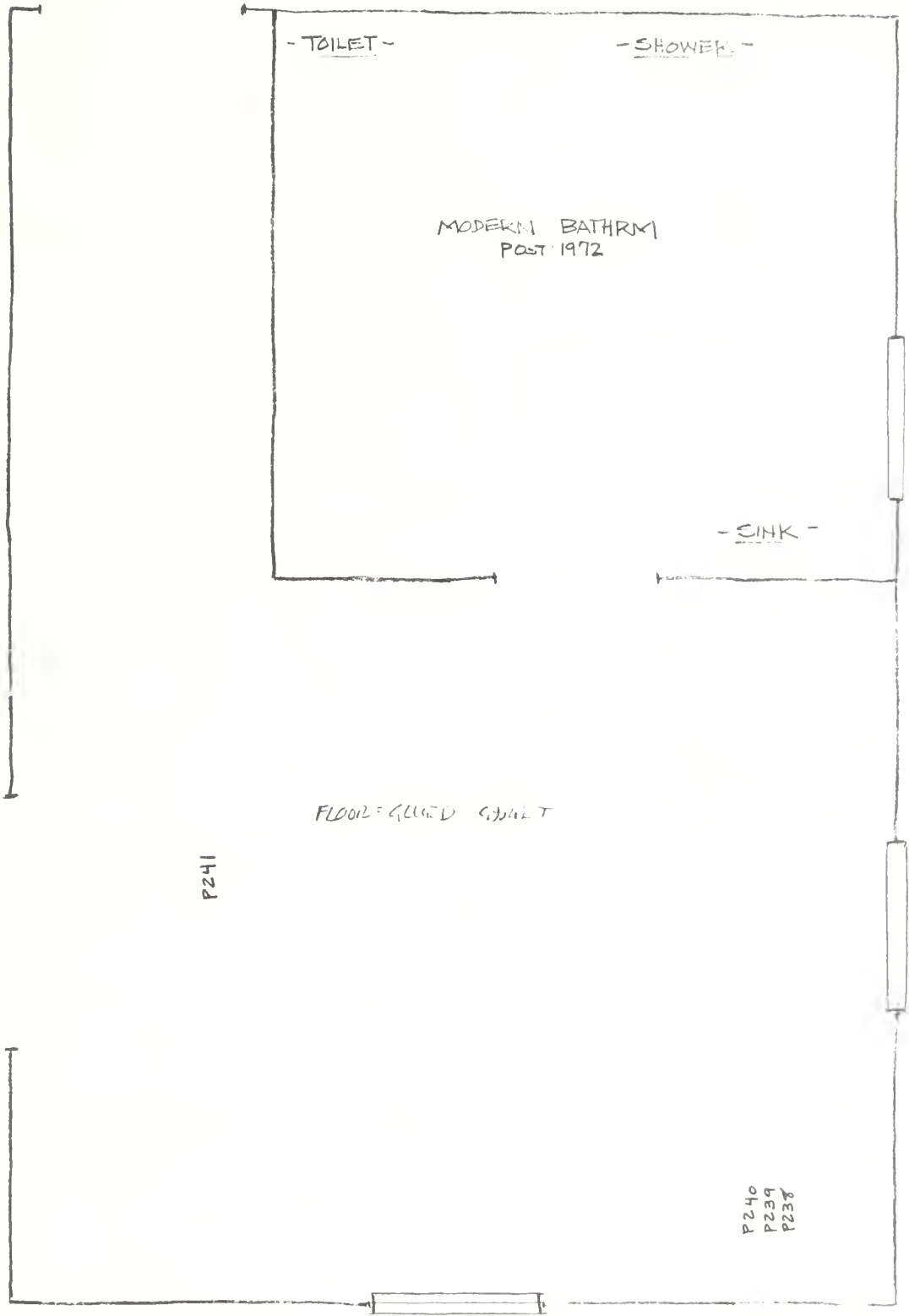

STANTON HOUSE
 SW RM - 1st FLR
 8 JUNE 02
 RM 104

STANTON HOUSE
 SOUTH RM
 8 JUNE 82
 RM 104

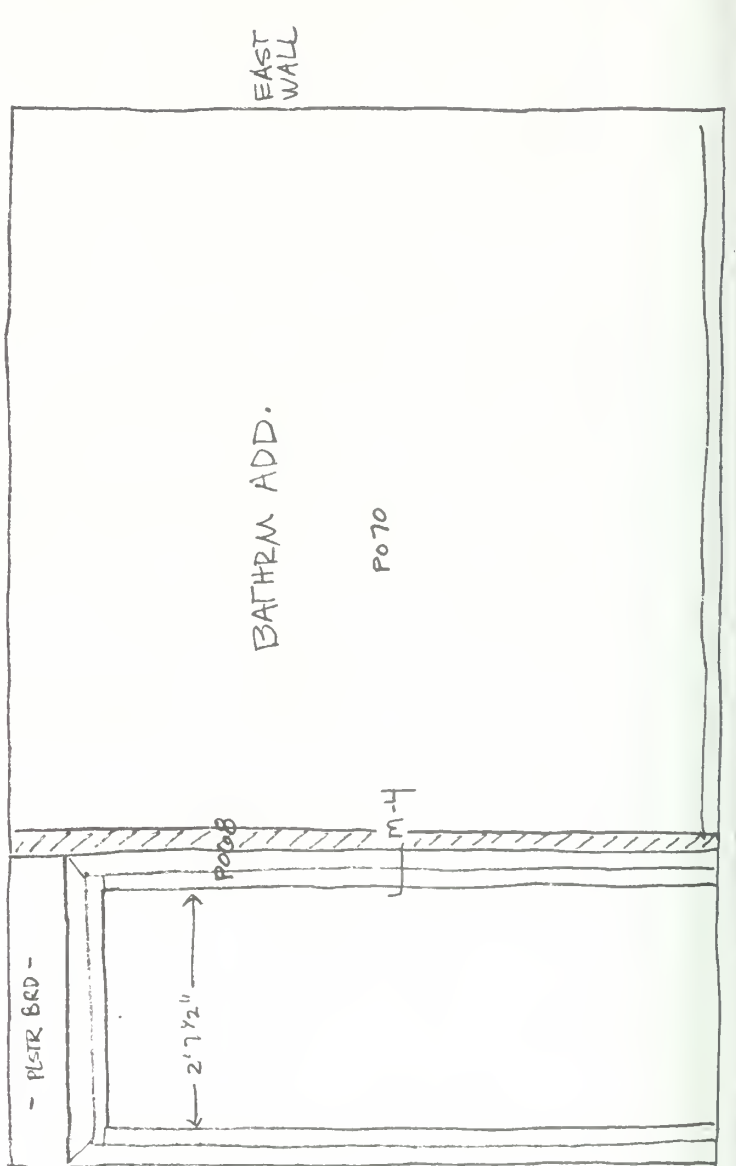
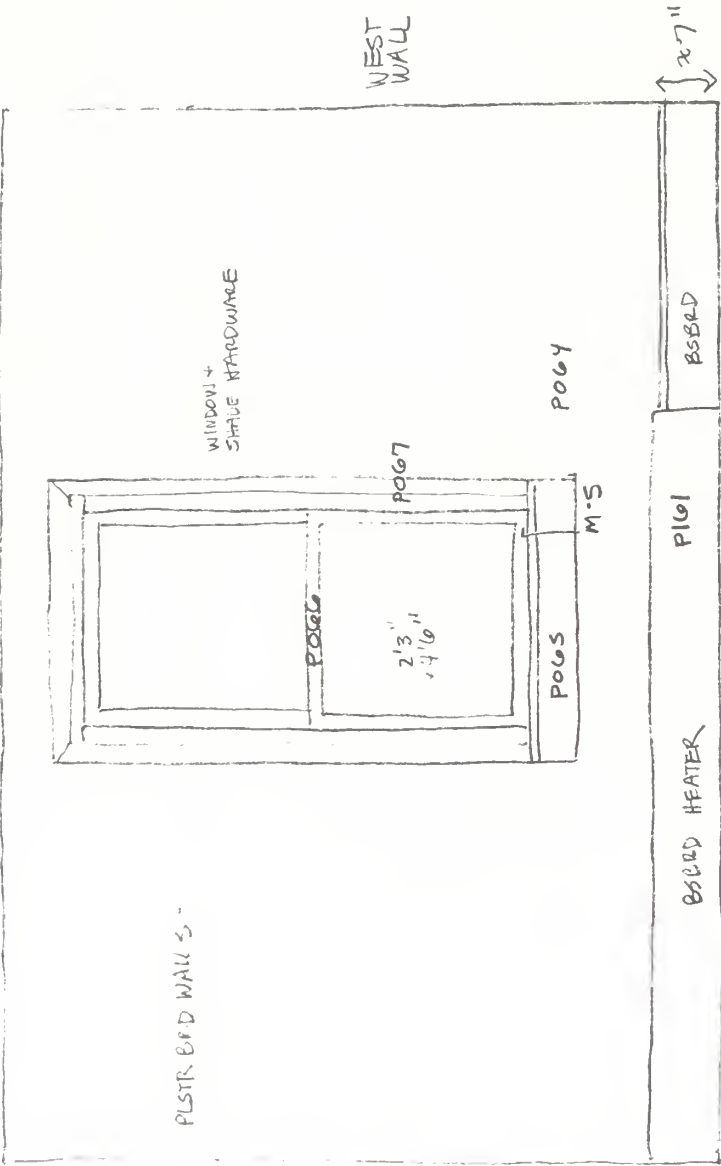

SOUTH WALL

NORTH WALL

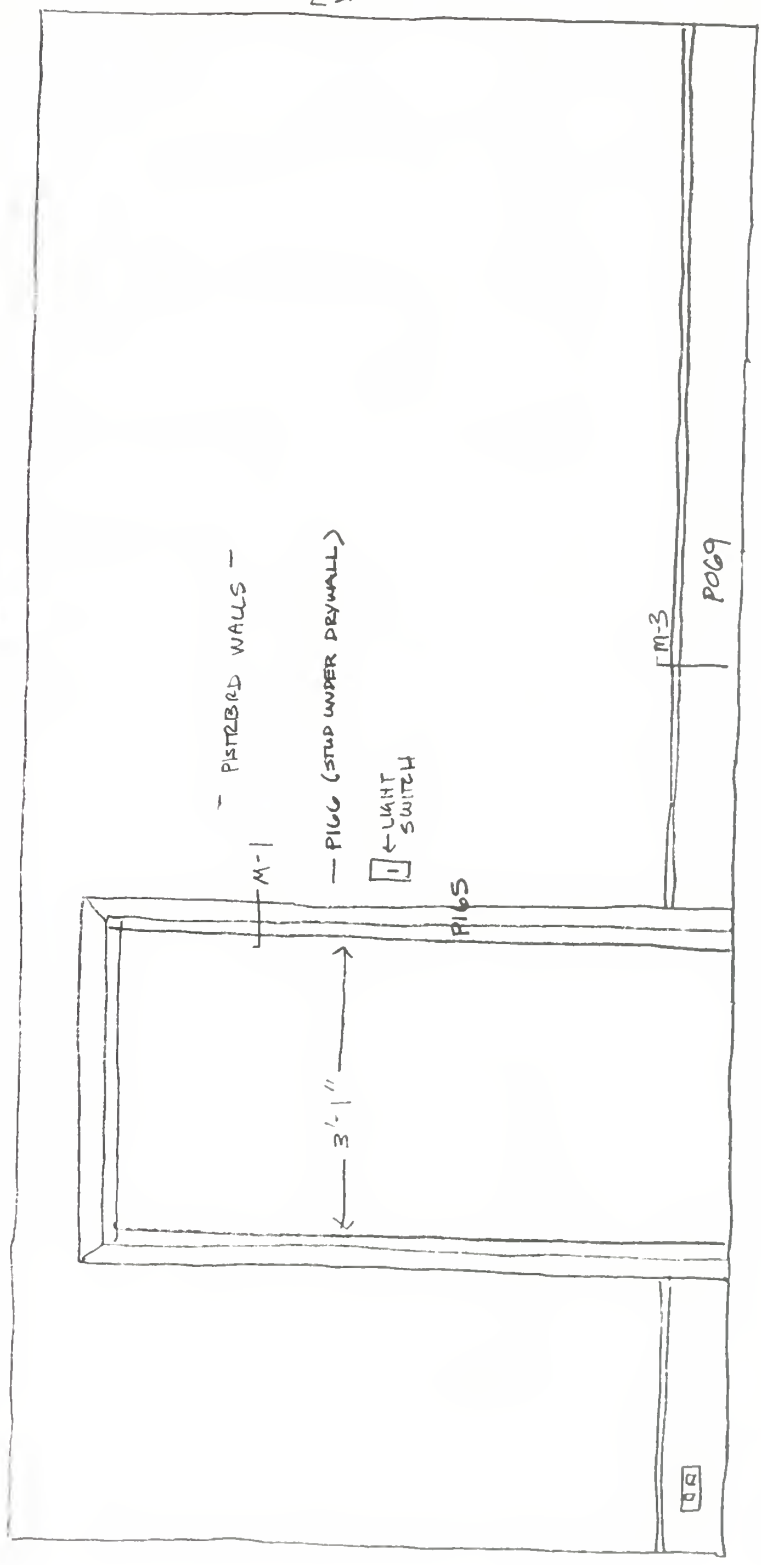
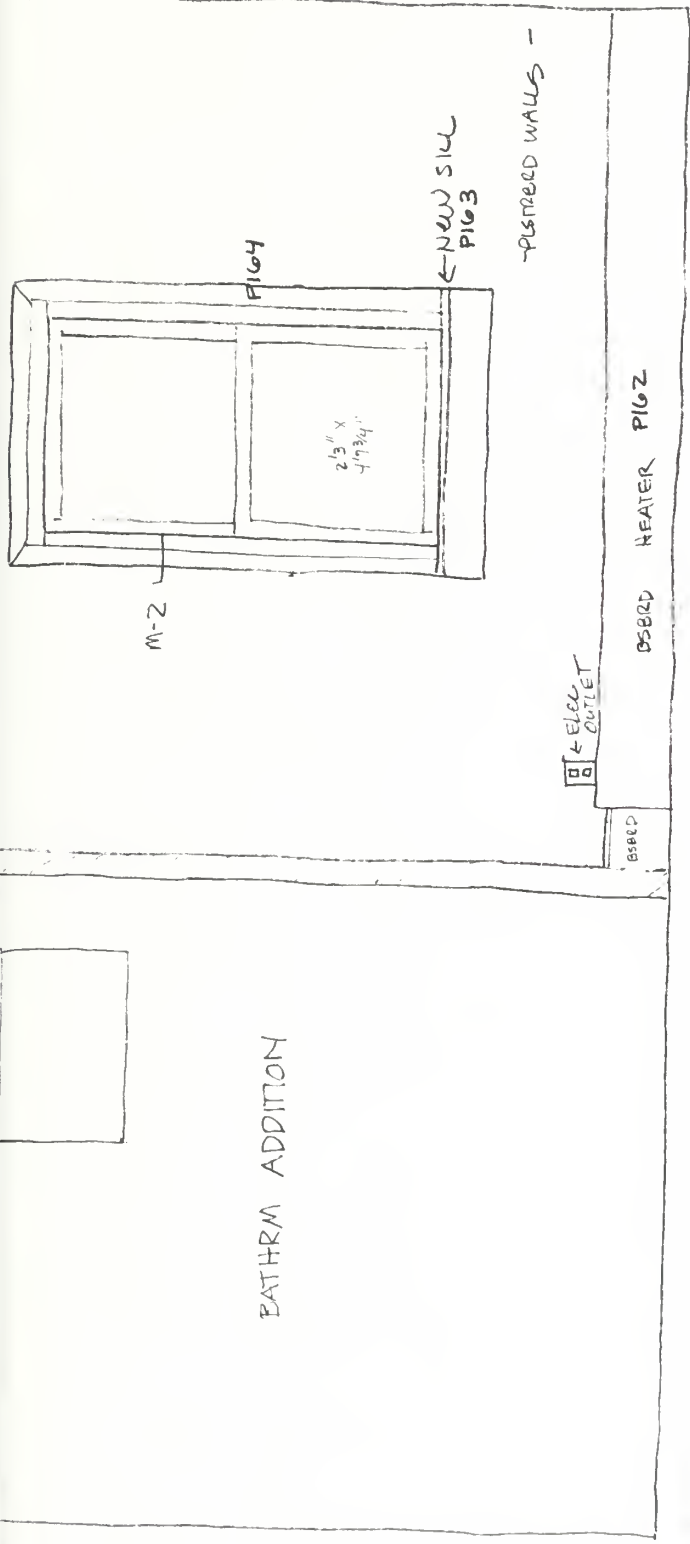

- PLASTER WALLS & CEILING
- FLOOR - GUMED CARPET

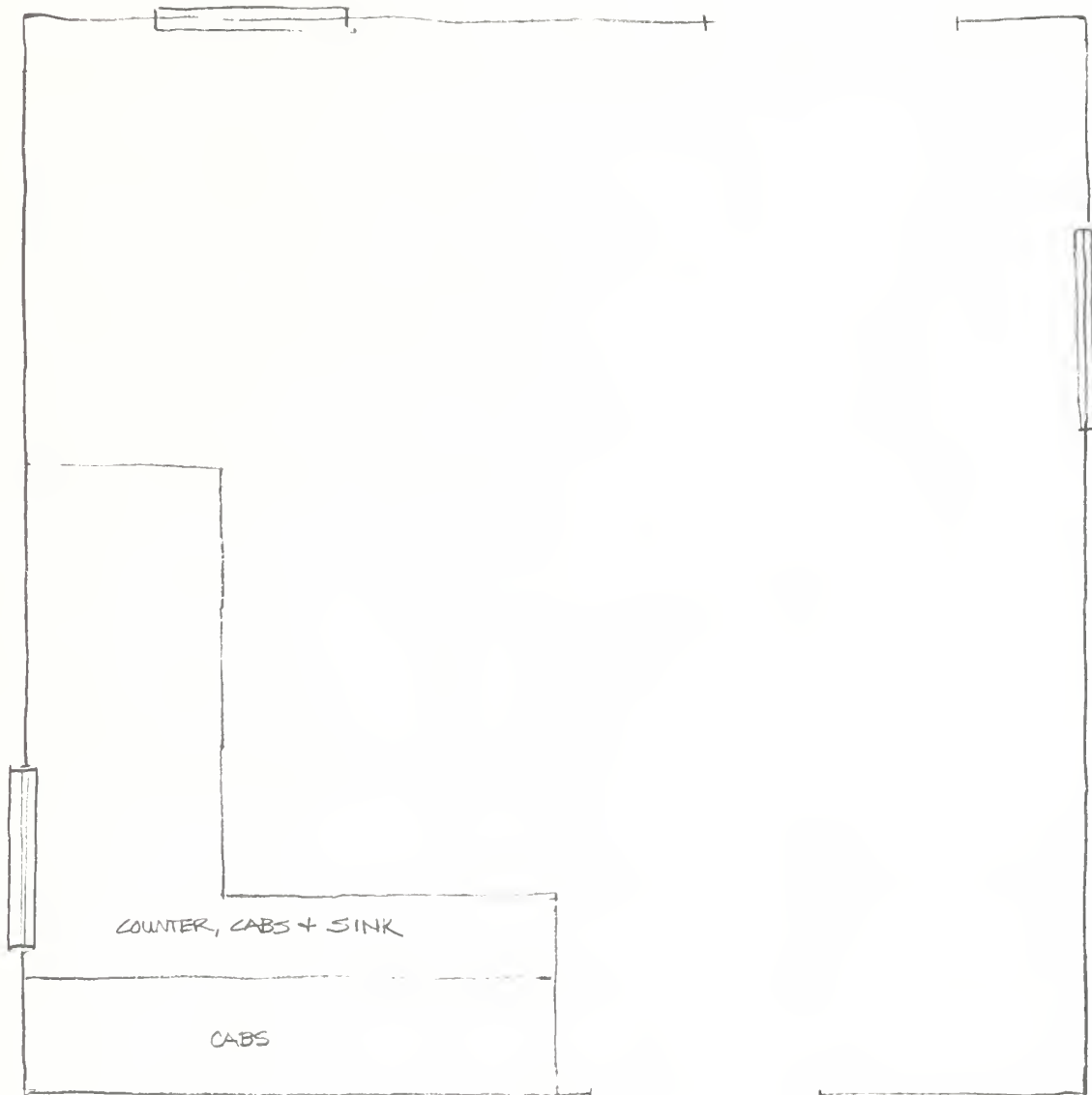

STANTON HOUSE
KITCHEN WING
8 JUNE 82
Rm 105

WEST WALL

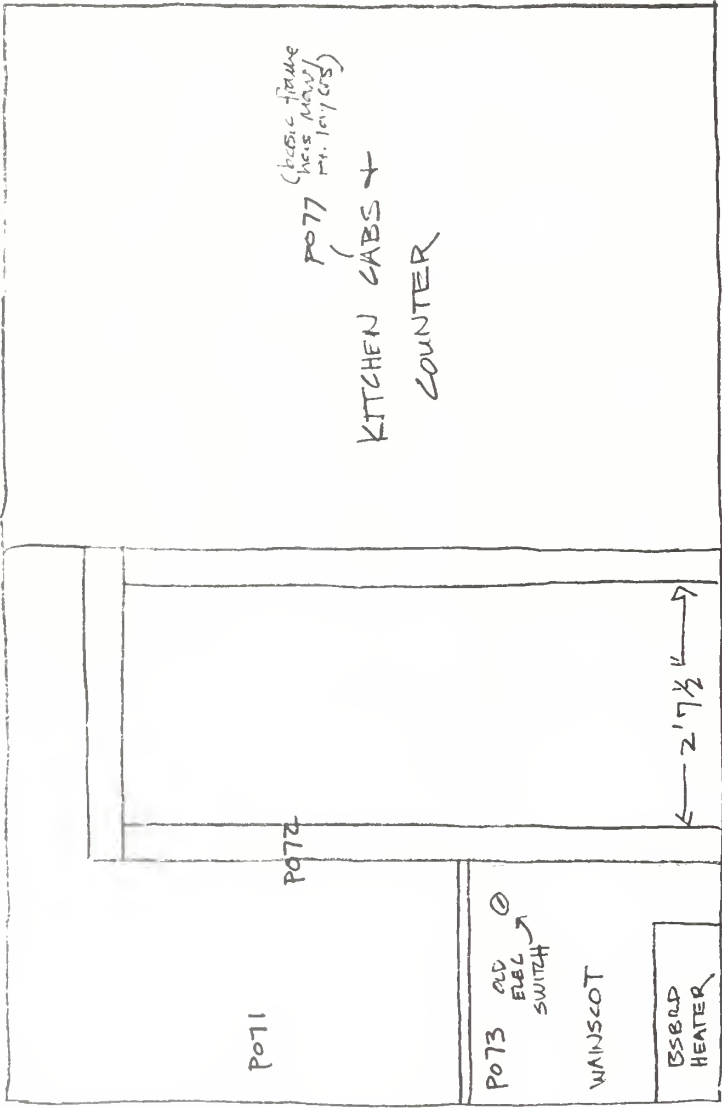

EAST WALL

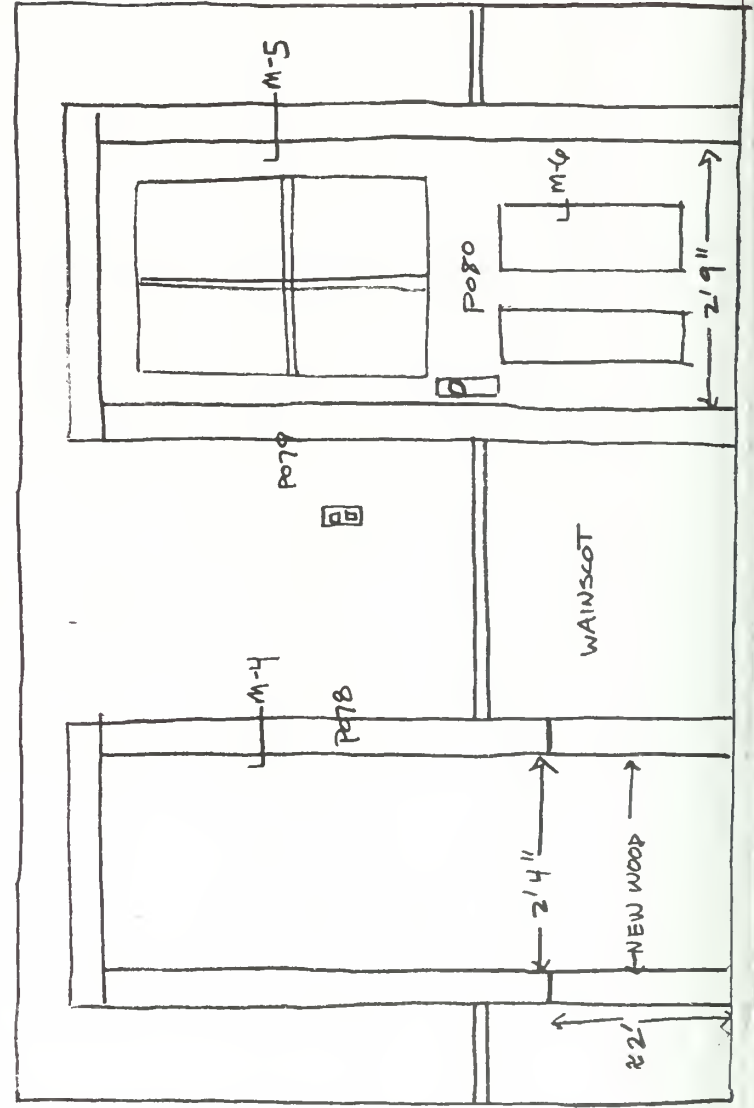

STANTON HOUSE
 KITCHEN WING
 8 JUNE 02
 RM 105

Handwritten note at the bottom right edge of the page.

11'5" x 11'1" - Live kitchen Tile Floor

SOUTH WALL

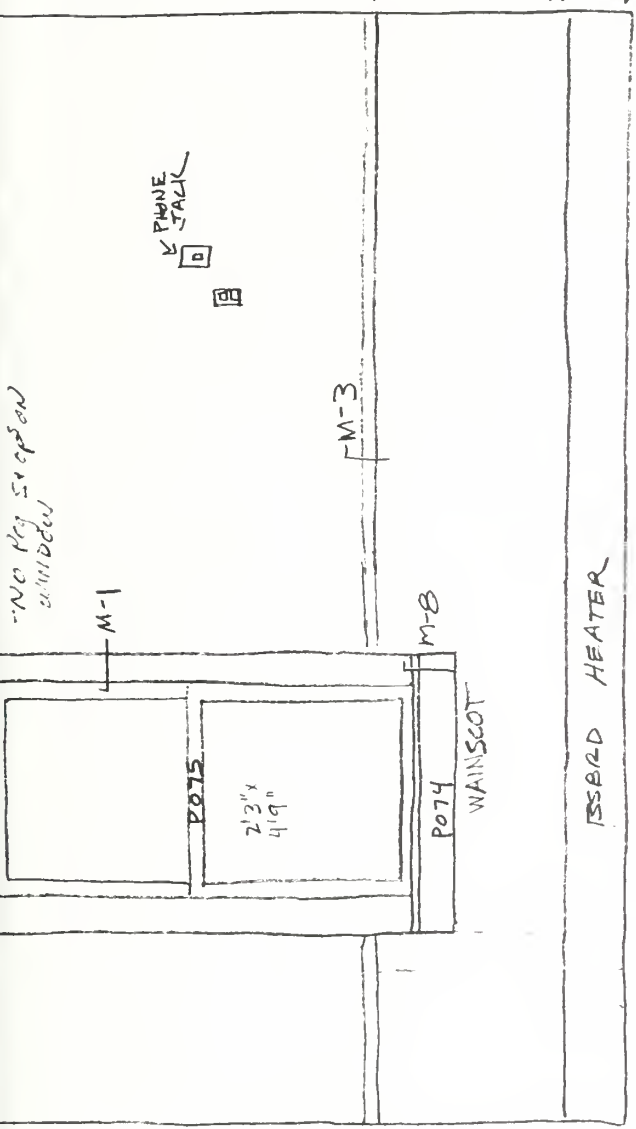

NORTH WALL

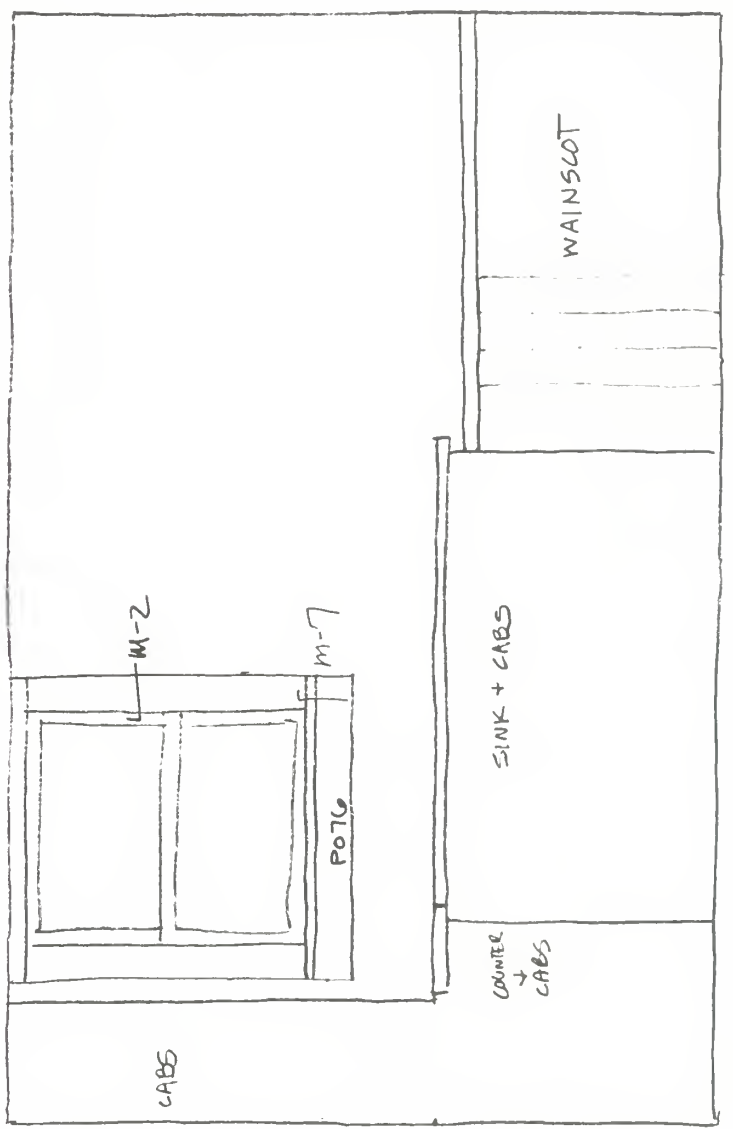

STANTON HOUSE
KITCHEN WING
8 JUNE 82
RM 105

STANTON HOUSE
 NORTH HALL + STAIRS
 2ND FLR - 9 JUNE 82

6'5" 11"
 stair 28" x 7 1/3"
 17'2"

CEILING = ACOUSTICAL TILE
 FLOOR = WIDE PLANK
 WALLS = MODERN PANELING
 ALL DOORS = MODERN

ELEC LIGHT IN CL. CEILING
 CLOSET INT. PLASTERED. H2O
 DAMAGE SE CORNER. EVIDENCE
 FROM INT. OF EARLY DOOR FRAME -
 3 HINGED DOOR. SWUNG SAME
 WAY. CL FLR NOT PTD.

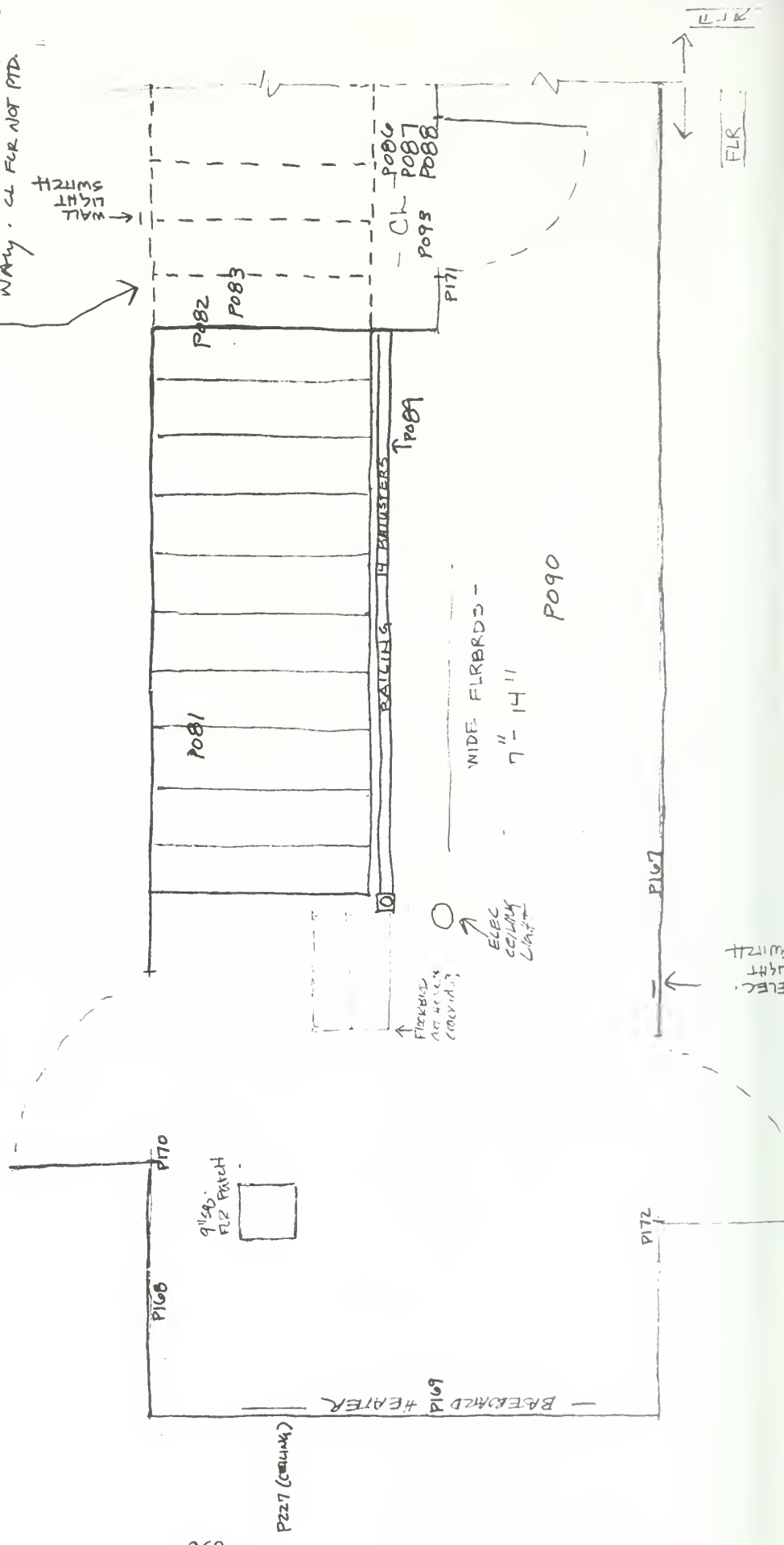

P114 (ceiling)
P228 (UNDER FRONT PORCH)

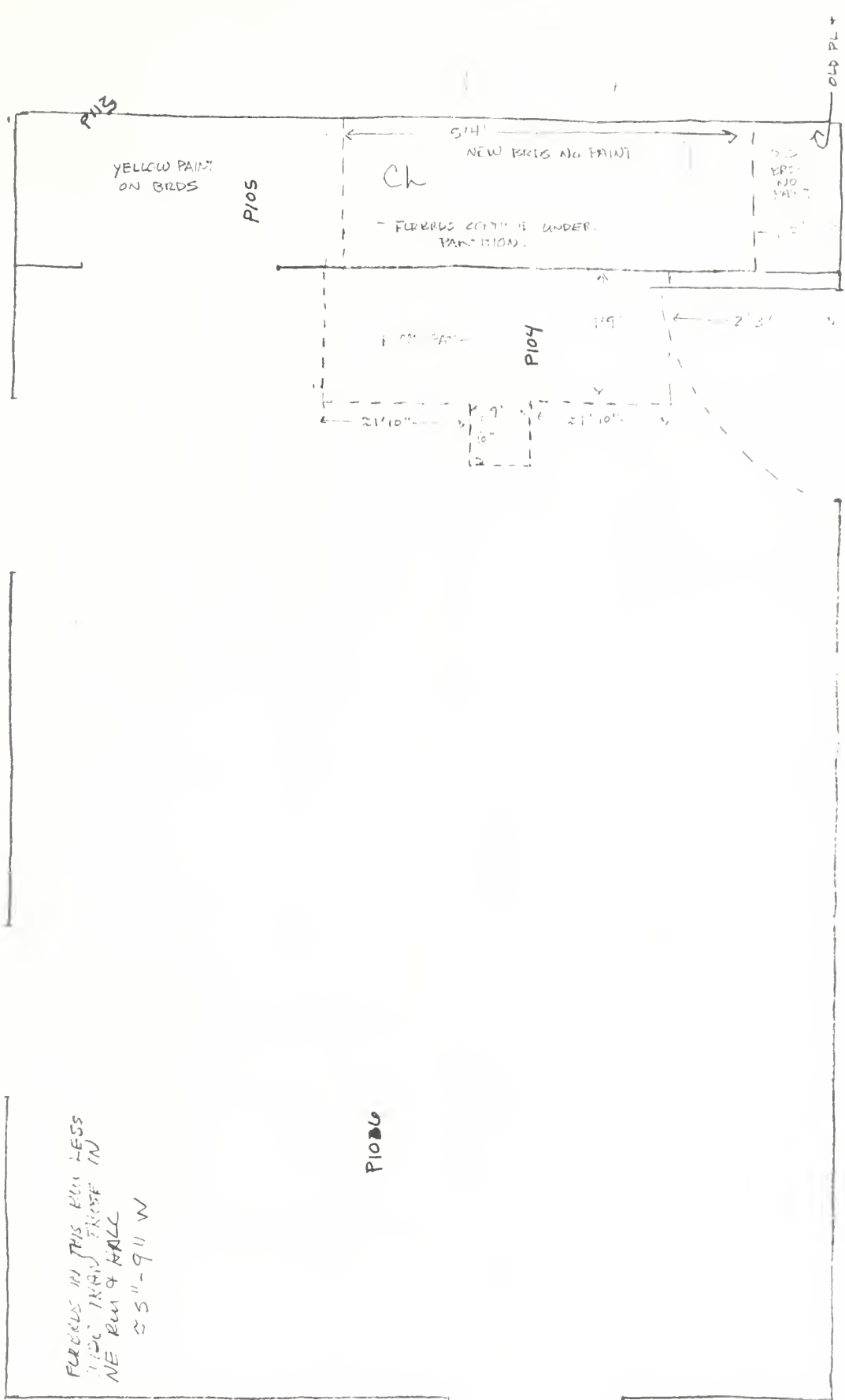

BIRDS IN THIS ROOM LESS THAN THOSE IN NE RM & HALL 55"-9" W

P106

BIRDS IN CL looks like reused wood some birds painted! some not. no pattern

STANTON MS
WEST FM - 2ND FLK.
9 JUNE 82. RM 201

17'
11'6"
7'4"

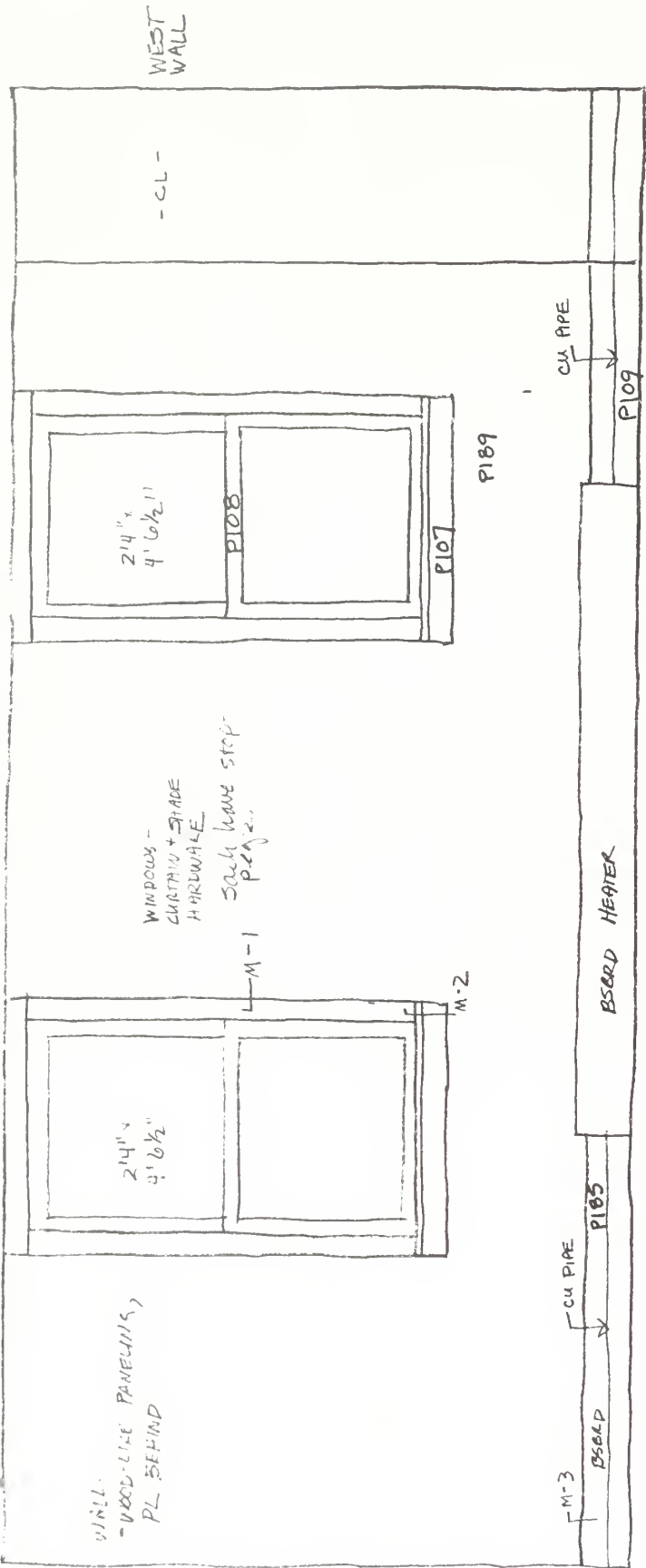

370

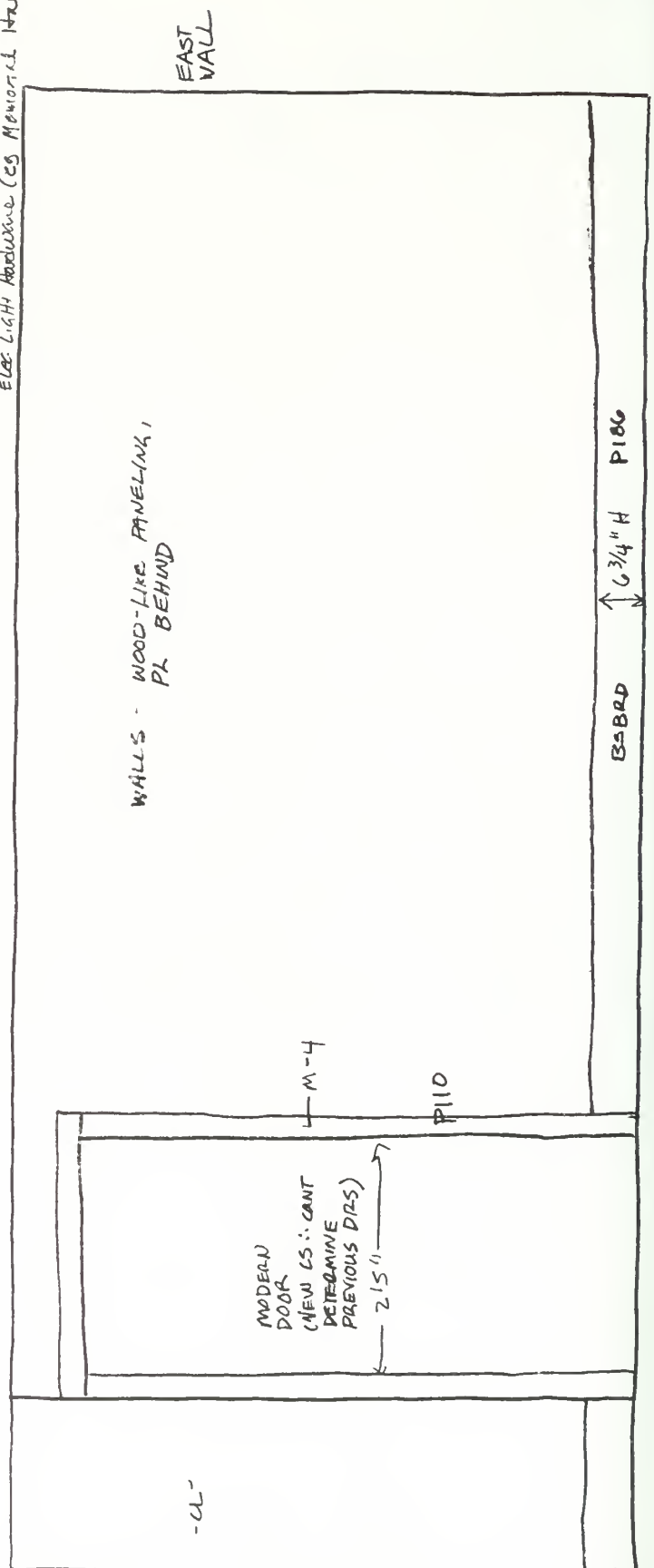

STANTON HS
WEST RM. 201 FL
9 JUNE 02
RM 201

STANTON HS
 WEST RM - 2nd FLR
 9 JUNE 82
 RM 201

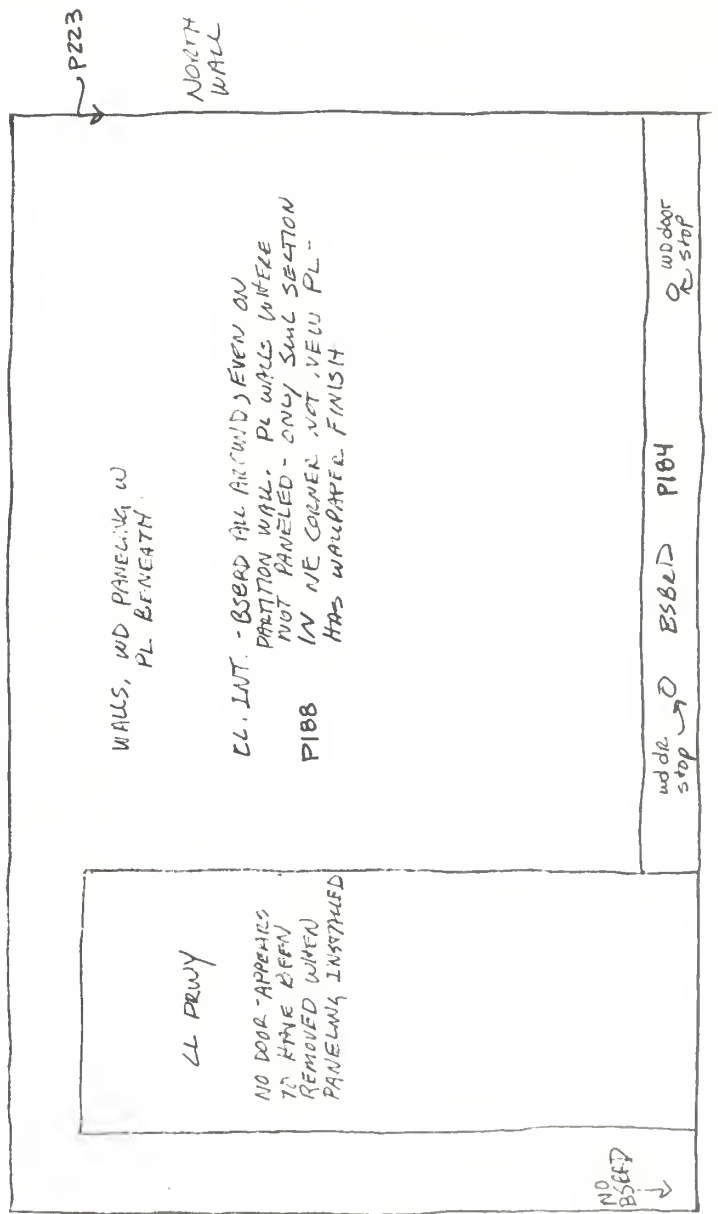
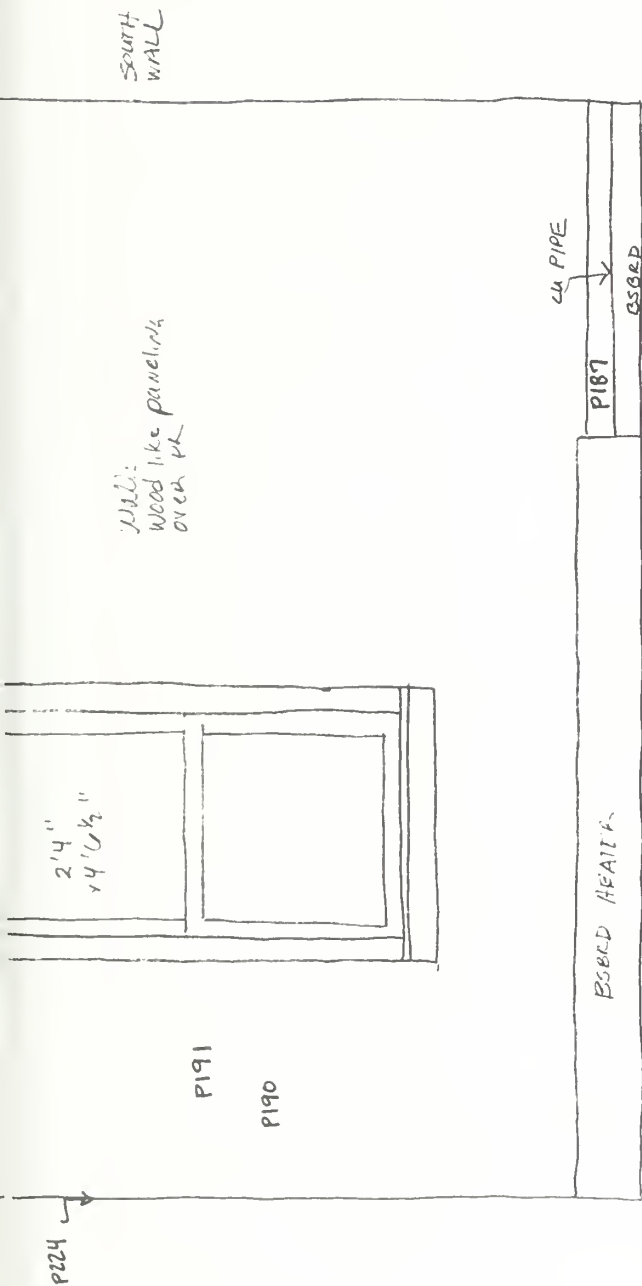

JAN 20, 1951
 NW CORNER
 EARLY CLOSET EVIDENCE

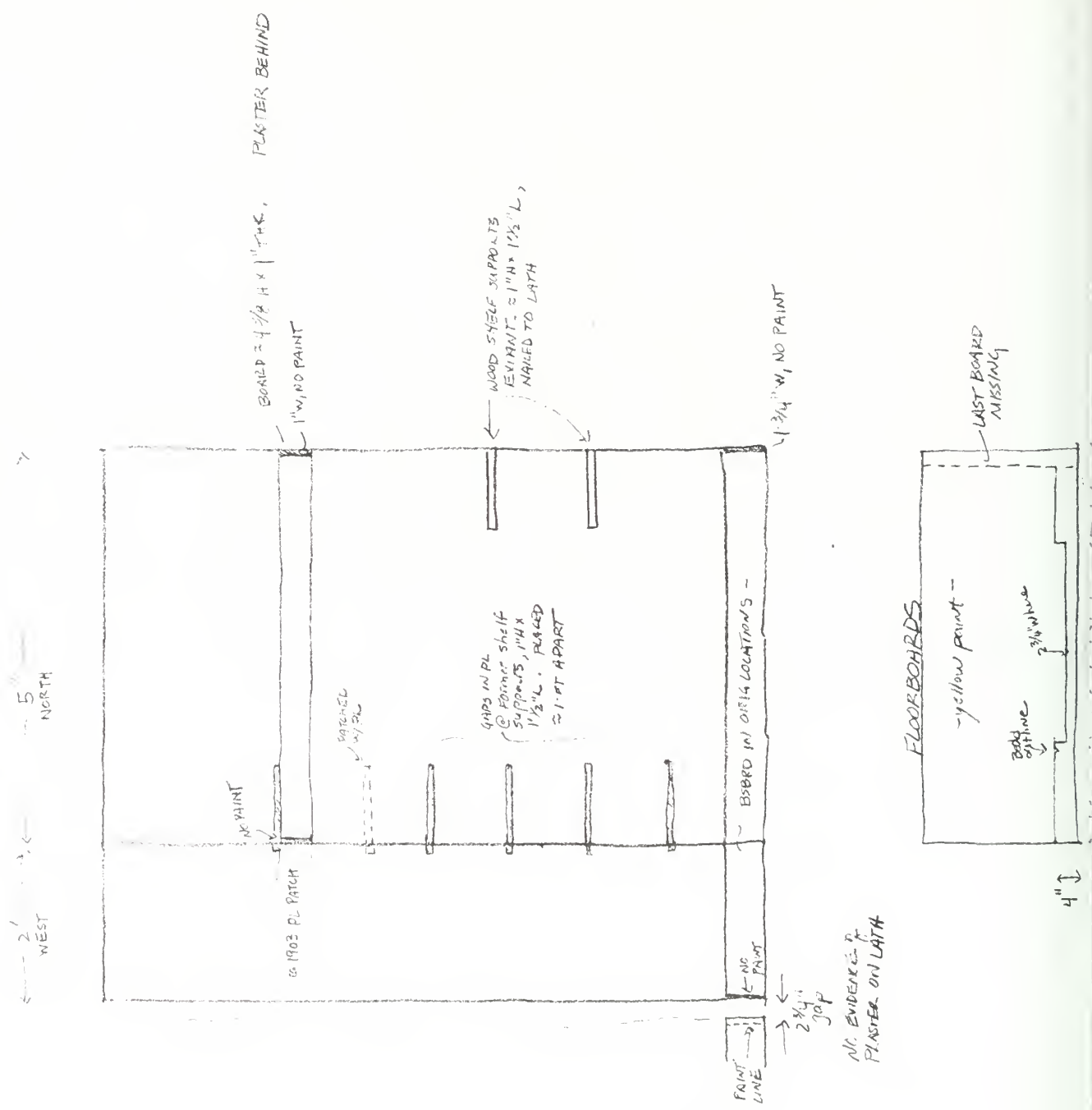

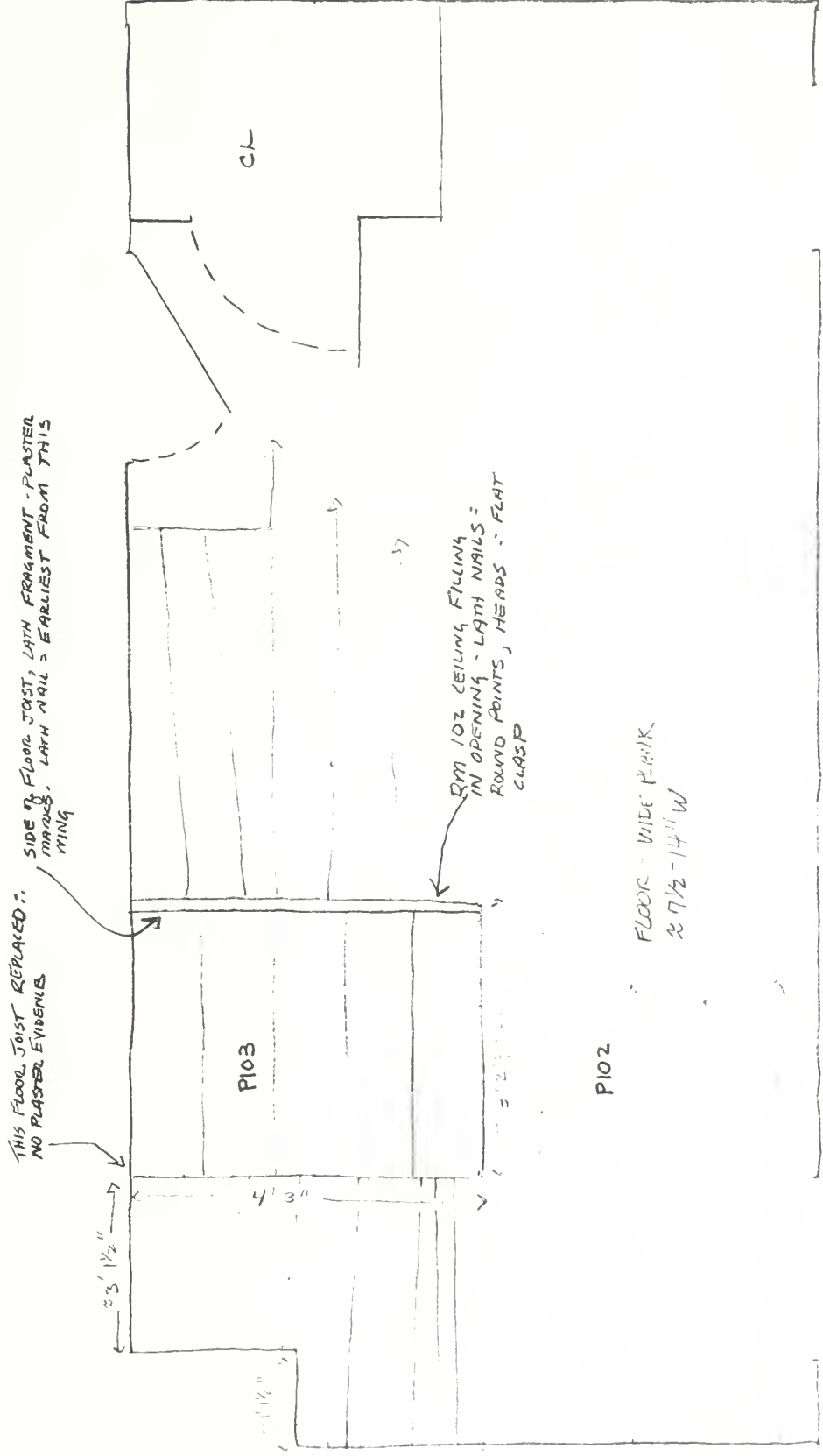

STATION H5
 102 RM - 2ND FLOOR
 9 JUNE 82
 RM 202

8'2"
17'
7'3"

EAST WALL

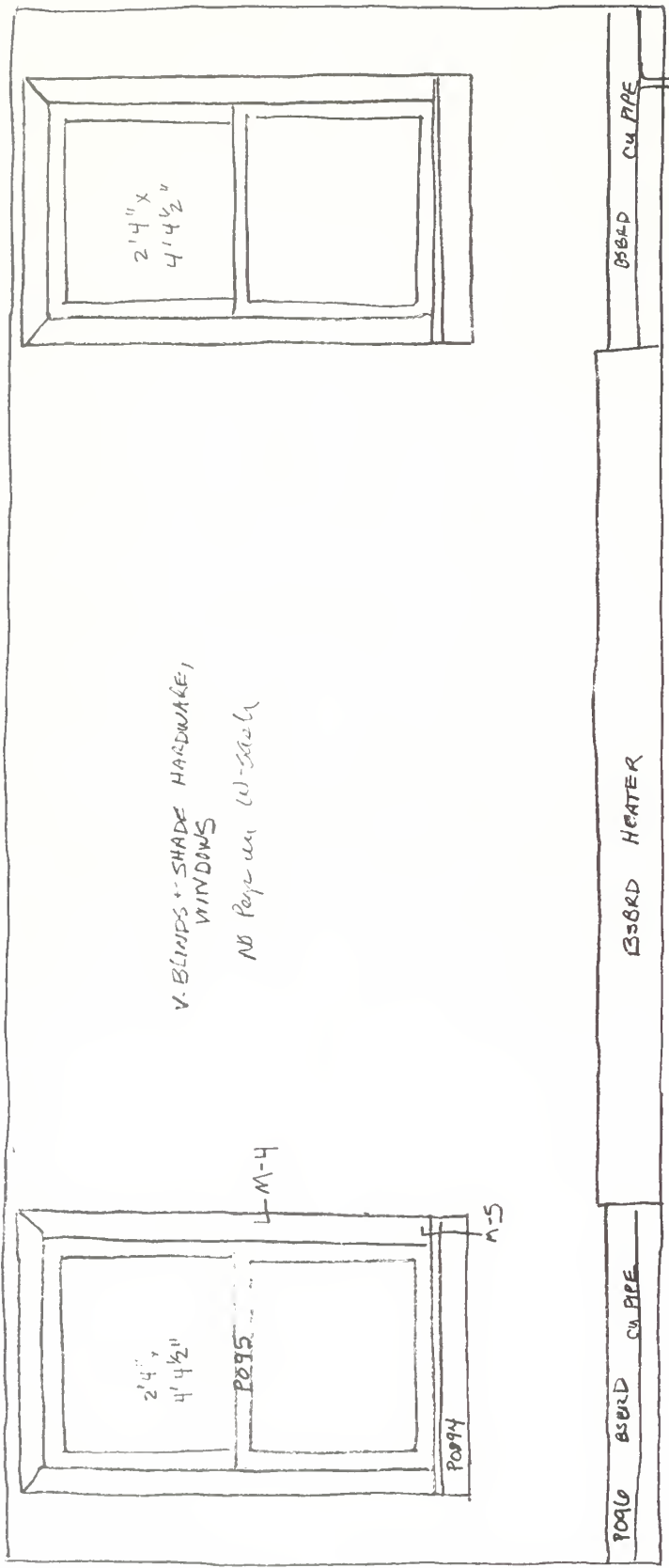

374

WEST WALL

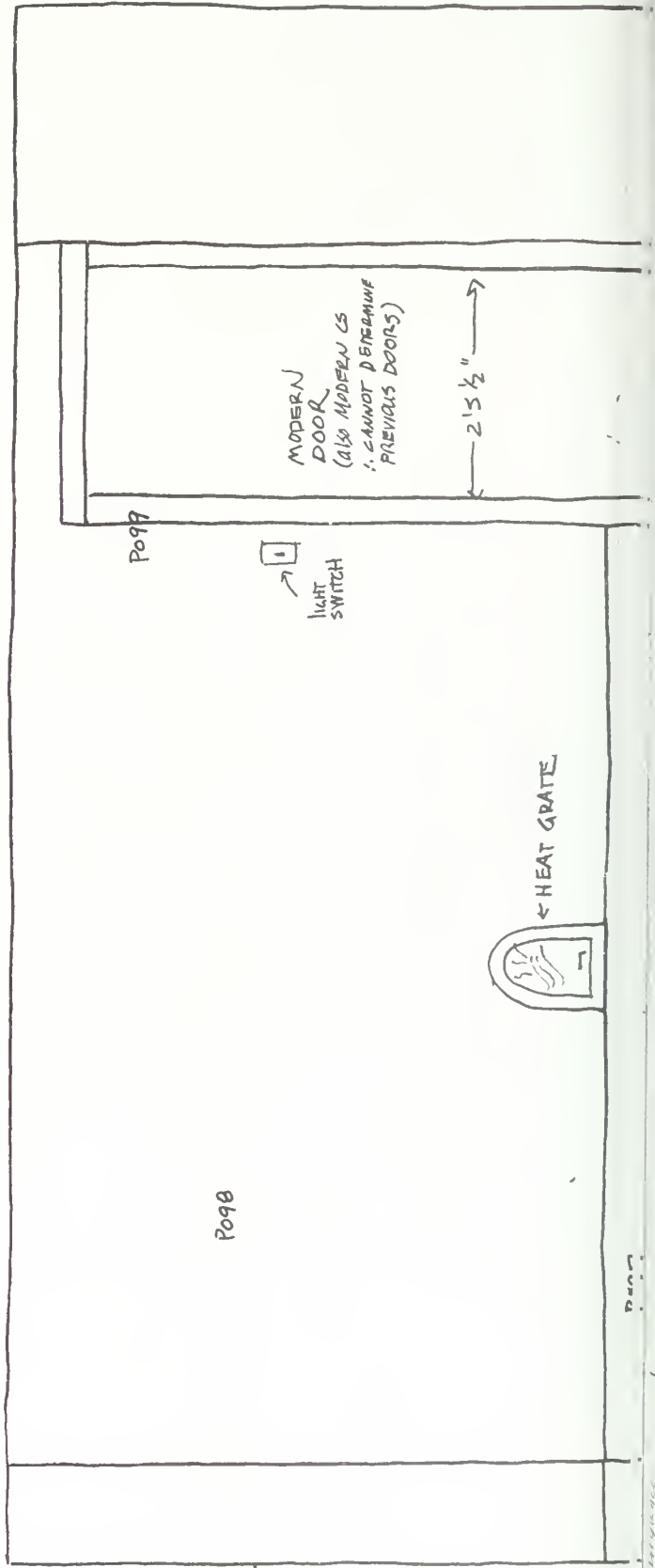

STANTON HS
NE RM-2ND FLE
9 JUNE 02
RM 202

- MODERN ELEC. LINE CEILING FIXTURE
- Former Master Bedroom

SOUTH WALL

P209 (MOJIB)
(Behind Chimney)

BSR 1' 1/2" H

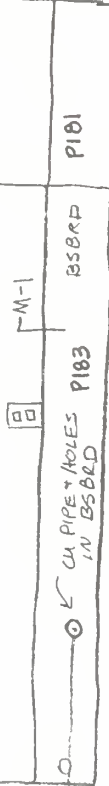

NORTH WALL

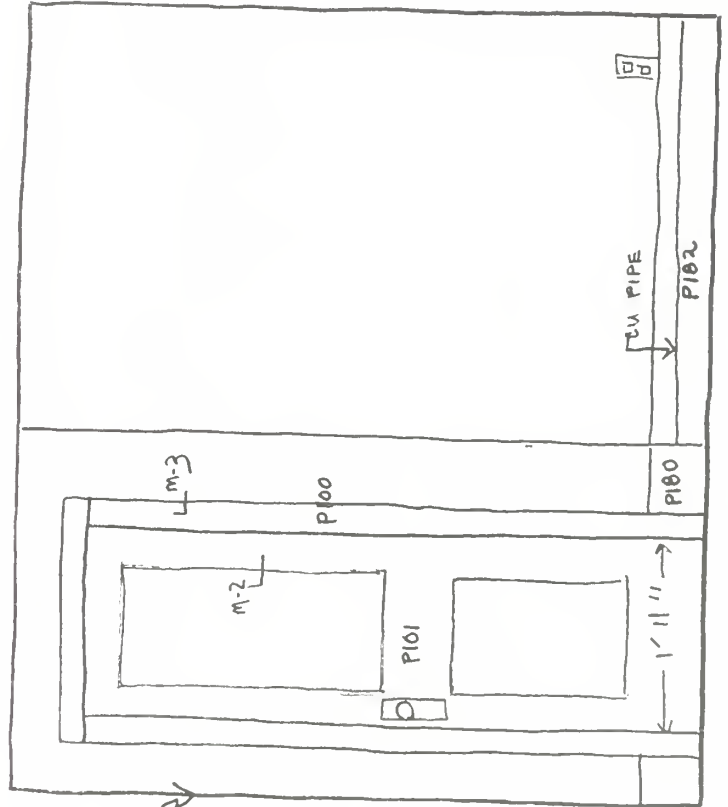

STANTON HOUSE
NE RM. 2ND FLR
9 JUNE 82
RM 202

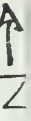

- DOORS + WINDOWS
CONTEMP W/ PANELING ON WALLS
- CEILING = ACOUSTICAL TILE

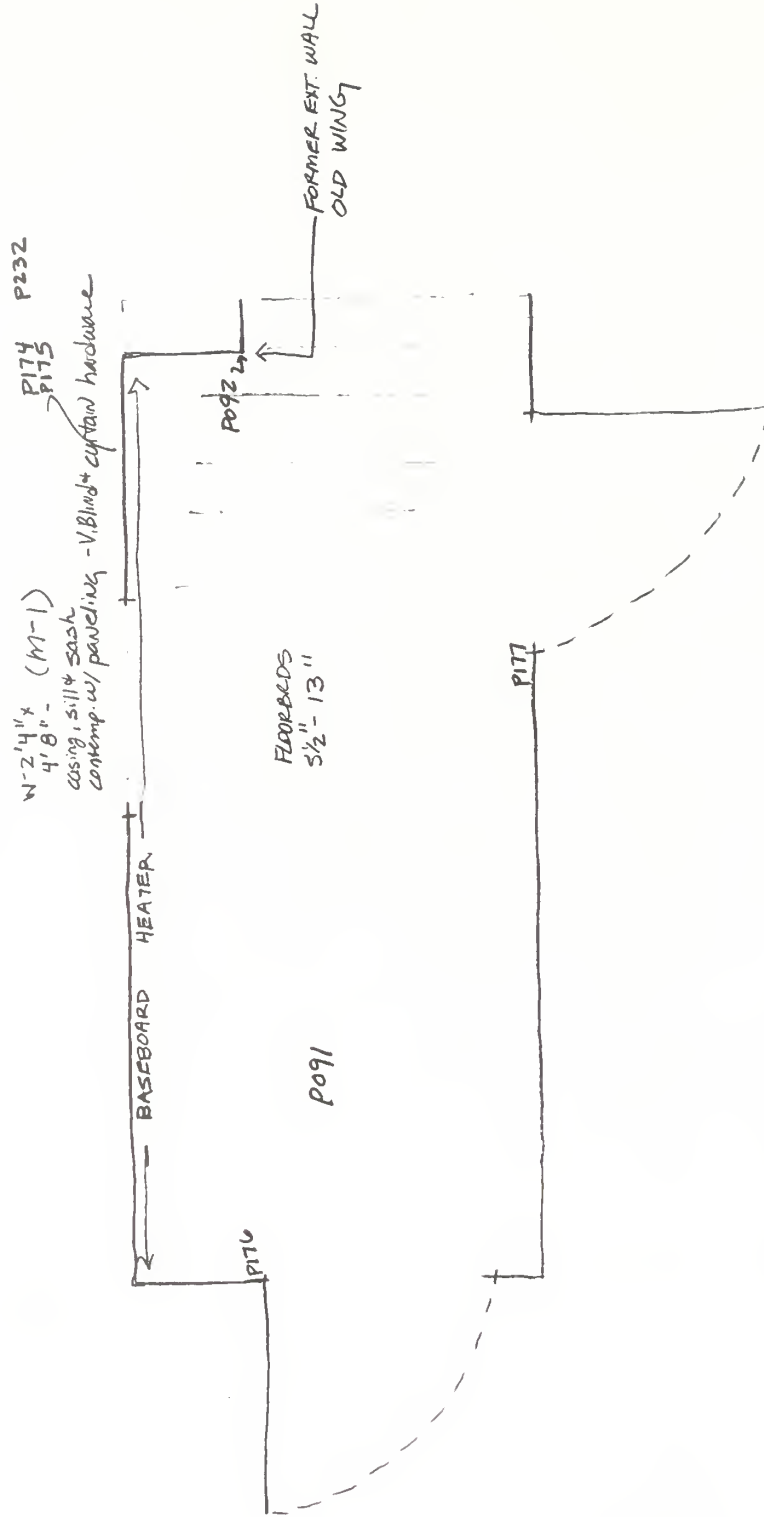

BATHRM - 2ND FLR
 9 JUNE 82
 RM 203

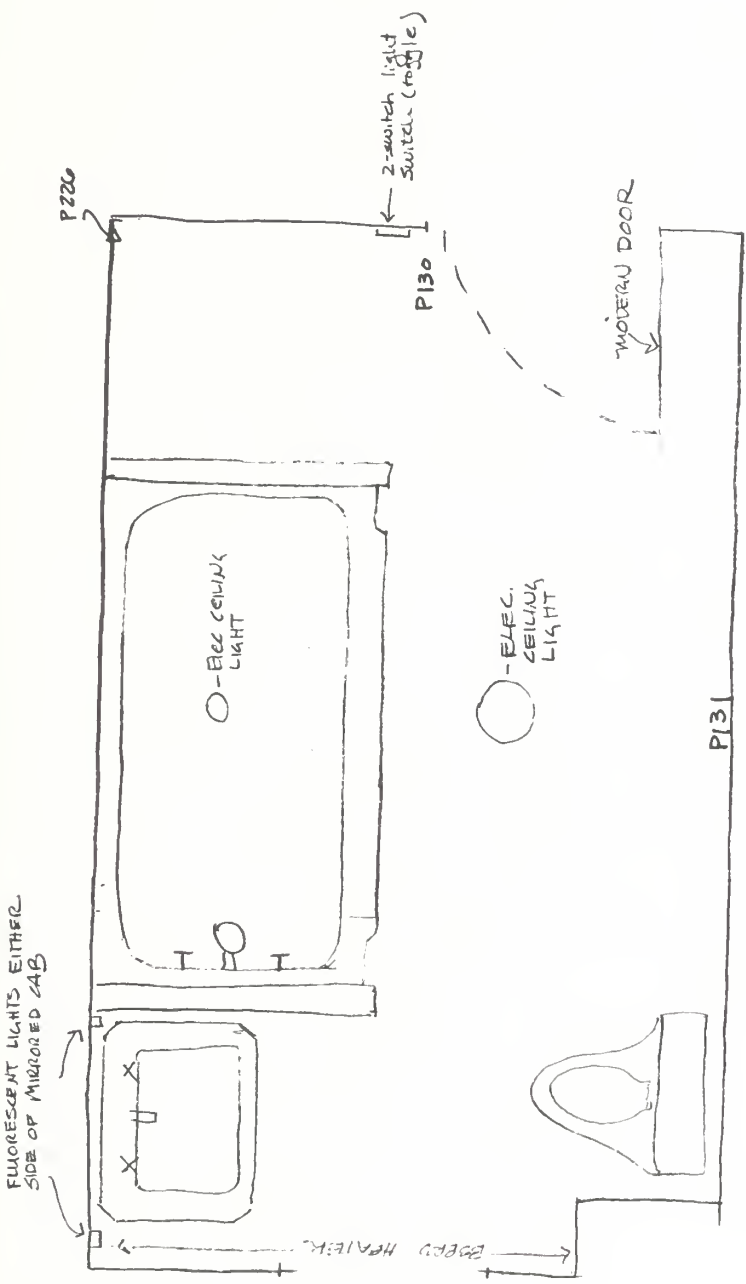

5'9" x 3'
 5'9" x 3'

P128 6/6 SASH W
 24" x
 P129 30 1/2" (11-11" SILL)
 1.81005 +
 (20000)
 measure
 window has
 peg strips

377

WALLS: MASSIVE TILE BRD FINISHED BLUE, DRYWALL ABOVE (MATCHED BRD WAINSCOT BENEATH TILE BRD)
 - SINK: PREFERRED STYLE, BUT ACCESSORIES (chrome towel rack, soap dish, cup holder, toothbrush holder)
 - TUB: "SINK" style of accessories (chrome towel rack, soap holder, etc style stainless steel)
 - WAINSCOT: DOOR JAMB FINISHING: Square edge



1 SEPT 82
 EAST BATHRM WALL
 RM 203

2 1/2" x 8" CLD 002

NEW GIRT

SIDE OF GIRT - SPACE, NO PLASTER - FORMER PARTITION?

3" WIDE

BEAM REMOVED (SECTION FOUND UNDER POUGH)

(WIDTH OF PAINT ON SILL) LINTEL = 2.7"

DOORWAY OPENING

~ 3' 0"

~ 5' 3"

~ 3'

ROSO RAIL

CUT BACK

RO48

RAIL (BAULFE SPACING 4 3/4" ON CTR)

CUT BACK

~ 2' 11"

RO49

RO46

NOTCH IN JOIST FOR POST

NOTCH IN JOIST FOR POST (DOWN RAIL)

~ 3' 6"

5' 1"

(1' 9")

FLOOR JOISTS

WORK OF 16 DEC. '82 RM 203

380

NEW GIRT

SIDE OF GIRT, SPACE, NO PLASTER - FORMER PARTITION?

HALL

CEILING
HATCH TO
ATTIC

- CH -

P117

OF CEILING
BULBS
(PLATE PLASTIC
AROUND)

- BEARD INCL ALL
WALLS - P121

P116

WOOD-GRAIN PAPER AROUND PERIMETER
FOR PTD RD BENEATH

P115

- NEWSPAPERS, FORMERLY UNDER - CARPET,
DATED JULY + AUG 1961
FOR PTD BIRD RD UNDER PAPERS

STORAGE

FUR below JOISTS
insulated w/ modern
fiberglass

~ 10' -

STATION HS
SW RM: 2ND FLR
9 JUNE 82
RM 204

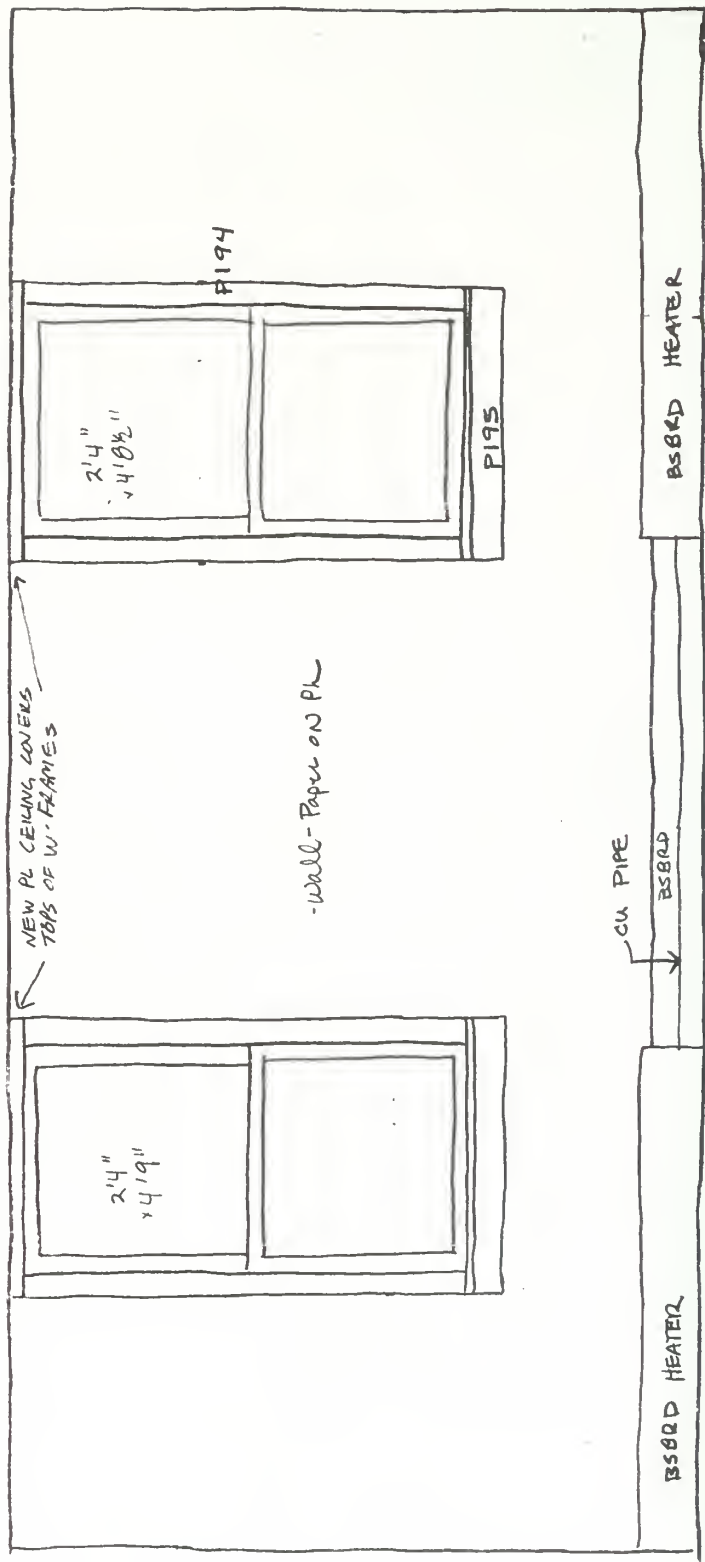
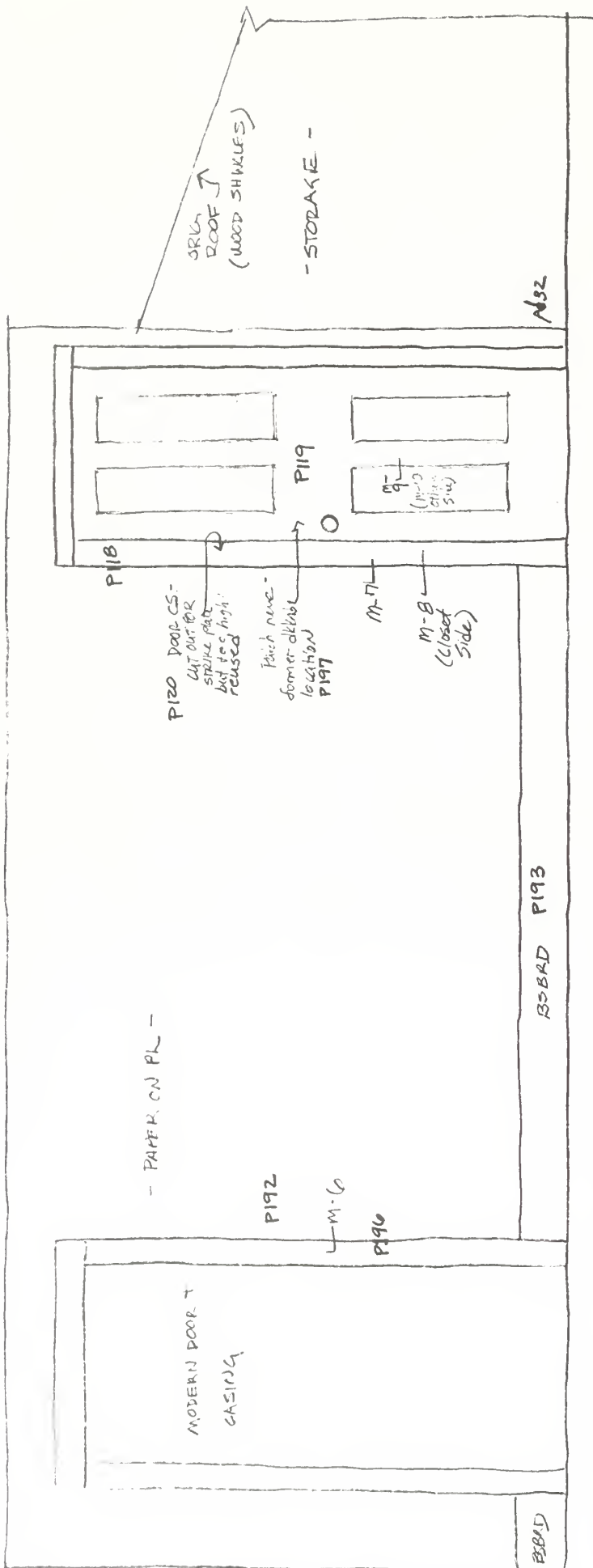

STANTON HSE
 SW RM. 204 FOR
 9 JUNE 82
 RM 204

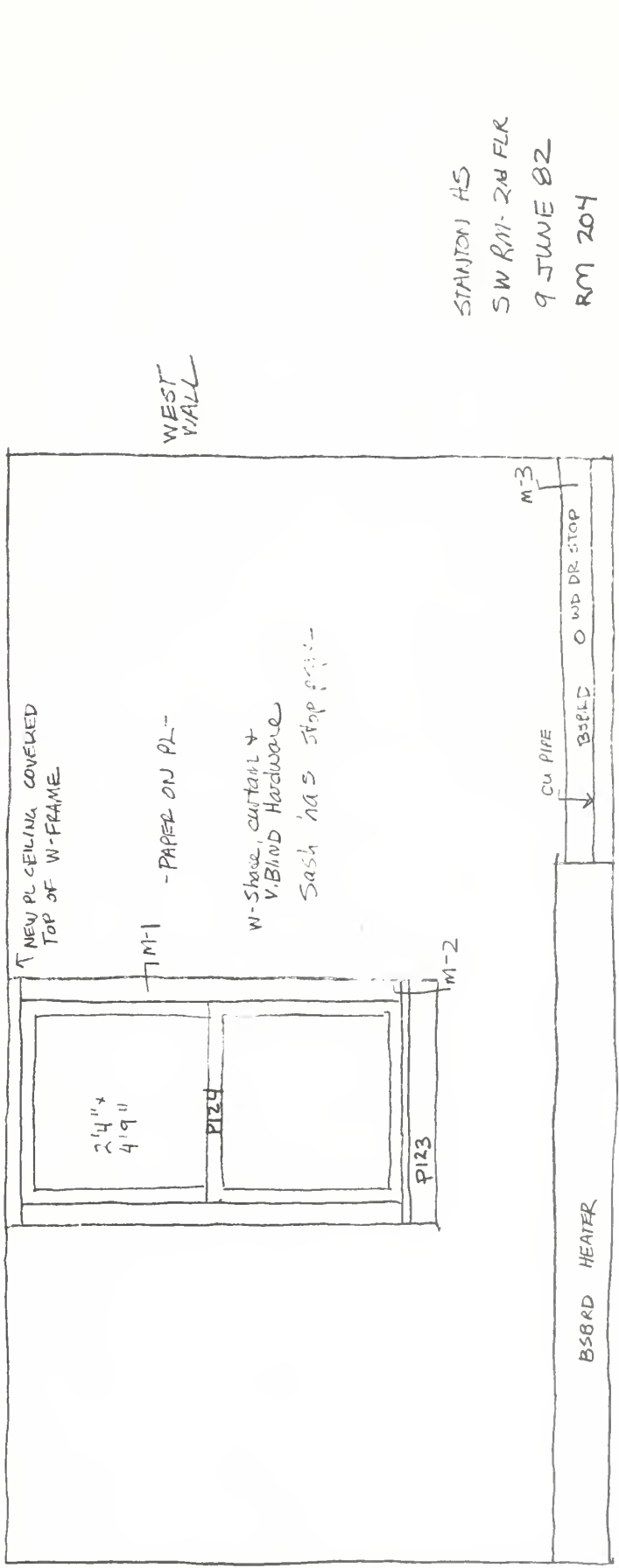
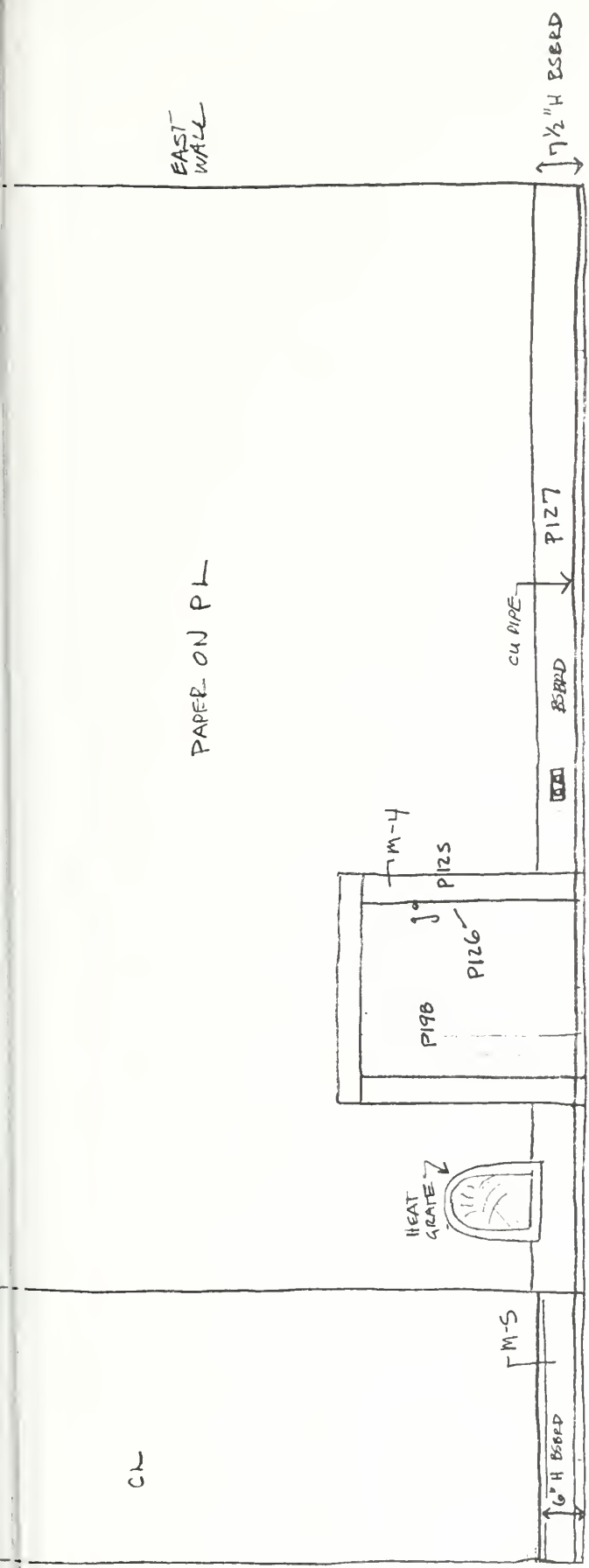

STANTON HS
 SW RM. 2nd FLR
 9 JUNE 82
 RM 204

101 + 210
 128 4.5
 2/13/11

STANTON HOUSE
 KITCHEN WING ATTIC
 10 JUNE 82
 RM 204

WEST WALL

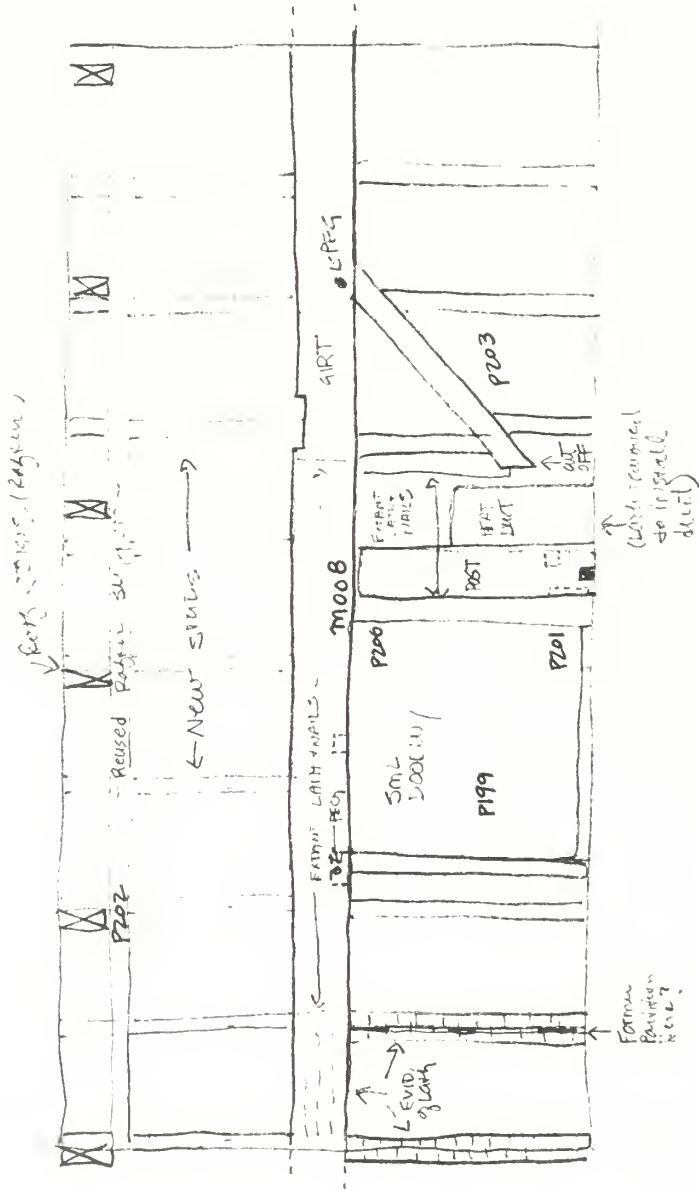

(ROOF)
 CEILING JOISTS = 2x6" ON 24".
 Can see wood of
 below roof studs

- Lath furring bds raised in roof pl- roof studs on stringer
 - also, some reused for end wall (stud)

VIII. BIBLIOGRAPHY

PUBLICATIONS

- Armitage, F.D. *Atlas of Paper-Making Fibers*. 1957.
- Banner, Lois W. *Elizabeth Cady Stanton: A Radical for Woman's Rights*. Boston: Little, Brown & Co., 1980.
- Bishop, J. Leander. *American Manufacturers From 1608 to 1860*, Vols. II and III. Philadelphia: Edward Young & Co., 1868.
- Blatch, Harriot Stanton. "Address to the National Women's Party Anniversary Celebration," July 20, 1923. Stanton Papers, Library of Congress.
- Blatch, Harriot Stanton, and Theodore Stanton. *Elizabeth Cady Stanton as Revealed in her Letters, Diaries and Reminiscences*, Vols. I and II. New York: Harper & Brothers, 1922.
- Casamassima, T.J., to Barbara Pearson. Conversation June 7, 1982.
- Downs, Arthus Channing, Jr. "The Introduction of American Zinc Paints, ca. 1850." *Bulletin of the Association for Preservation Technology*, Vol. VI, No. 2, 1974.
- Du Bois, Ellen Carol (ed). *Elizabeth Cady Stanton, Susan B. Anthony, Correspondence, Writings, Speeches*. New York: Schocken Books Inc., 1981.
- Empire Gas & Electric Company. "Field Inventory, 1921," as relayed to Barbara Pearson by Mr. Cooley, Electrical Engineering Division, New York Gas & Electric Corp., January 11, 1984.
- General Management Plan, Women's Rights National Historical Park/New York*. National Park Service, March 1986.
- Amendment to the General Management Plan of 1986*. National Park Service, January 1991.
- Gilmore, Andrea M. "Lindenwald Wallpapers." Typescript draft, North Atlantic Historic Preservation Center, NPS, February 1980.
- Goss, W.F.M. *Bench Work in Wood*. Boston: Ginn & Co., 1887 and 1890.
- Grebinger, Paul. "Report to the National Park Service, Archaeological Investigations, E.C. Stanton House, Seneca Falls, March 1983." Typescript, Women's Rights NHP.
- Grebinger, Paul, and Corinne Guntzel. "The Domestic Economy of Elizabeth Cady Stanton: Her House and Its Artifacts." Typescript, Women's Rights NHP, 1981.
- Guntzel, Corinne. "Domesticity and Equality: Elizabeth Cady Stanton on Home Life." Typescript Women's Rights NHP, July 17, 1982.

- . "History of the Stanton House." Typescript, Women's Rights NHP, June 1, 1982.
- Guntzel, Corinne, and Judith Wellman. "Guide—Elizabeth Cady Stanton in Seneca Falls: A Compilation of Her Papers." Typescript, Women's Rights NHP, June 1, 1982.
- Hamlin, Talbot. *Greek Revival Architecture in America*. New York: Oxford University Press, 1944 (Dover reprint, 1964).
- Hoffman, Jeff. "The Excavation of the Stanton House: A Comparison of Two Provenances." Typescript, 1983.
- Hsu, Dick Ping, and Linda Towle. "Report on the Archeology of the Stanton House, Women's Rights NHP." Typescript, Division of Cultural Resources, North Atlantic Region, NPS, Boston, MA, Nov. 1983.
- International Association of Master Painters and Decorators. *Painting & Decorating Working Methods*. New York: Theo Audel, 1922.
- Kellog, Day Otic (ed). "Floor Cloth." *The Encyclopedia Britannica*, Vol IX. New York: The Werner Co., 1901.
- Klionsky, Hymen, to Judy Wellman. Conversation August 31, 1982.
- Lafever, Minard. *The Beauties of Modern Architecture*. Da Capo Press, 1968 (reprint of the 1835 first edition).
- . *The Modern Builder's Guide*. Dover, 1969 (reprint of the 1833 first edition).
- Lamps and Other Lighting Devices 1850-1906*. Princeton, NJ: The Pyne Press, 1972.
- Lanly, Jacob. *The Architecture of Minard Lafever*. New York: Columbia University Press, 1970.
- Lawrence, Margaret Stanton. "Elizabeth Cady Stanton 1815-1915." Vassar.
- Little, Nine Fletcher. *American Decorative Wall Painting 1700-1850*. New York: E.P. Dutton & Co., Inc., 1972.
- Lutz, Alma. *Created Equal: A Biography of Elizabeth Cady Stanton*. New York: The John Day Co., 1940.
- Lynn, Catherine. *Wallpaper in America: From the Seventeenth Century to World War I*. New York: W.W. Norton & Co., Inc., 1980.
- Major, Howard, AIA. *The Domestic Architecture of the Early American Republic: The Greek Revival*. Philadelphia: J.B. Lippincott Co., 1926.
- Masury, John W. *House-Painting, Carriage-Painting and Graining*. New York: D. Appleton & Co., 1881.

- McManus, Edward. "North Atlantic Region Conservation Condition Report and Treatment Proposal" for 1859 one-cent piece. Typescript, on file at Women's Rights NHP, November 17, 1982.
- Merriman, Marcus. "Merriman's Window Spring & Bolt," April 14, 1835. *Early Unnumbered U.S. Patents 1790-1836*. Microfilm, Science Research Library, Boston Public Library.
- Montgomery Ward and Company. *Ward's Wallpaper Style Book*, 1942. Private collection of E. Blaine Cliver.
- Mosley, Theresa. "Elizabeth Cady Stanton House." Building Structure Inventory Form, Division for Historic Preservation, New York State Parks and Recreation, Albany, New York, Summer 1982.
- Moss, Roger. *Century of Color, 1820-1920*. Watkins Glen, NY: The American Life Foundation, 1981.
- Nelson, Lee H. *Nail Chronology as an Aid to Dating Old Buildings*. Technical Leaflet #48, 1968. Nashville, TN: American Association for State and Local History.
- Newcomb, Rexford. *Architecture of the Old North-West Territory*. Chicago: The University of Chicago Press, 1950.
- Peterson, Charles E., FAIA (ed). *Building Early America*. Radnor, PA: Chilton Book Co., 1976.
- Petravage, Carol. *Historic Furnishings Study: Stanton House, Wesleyan Chapel, and McClintock [sic] House, Women's Rights National Historical Park, Seneca Falls, New York*. Harpers Ferry Center, NPS, 1988.
- Plenderleith, Harold J., and A.E.A. Werner. *The Conservation of Antiquities & Works of Art*. London: Oxford University Press, 1976.
- Priess, Peter. "Wire Nails in North America." *Bulletin of the Association for Preservation Technology*, Vol. V, No. 4, 1973.
- The Reveille*, "Convention Days '82" issue. Seneca Falls, NY, July 14, 1982.
- Russell & Erwin Co., *Illustrated Catalog of American Hardware*, 1865.
- Reilly, James M. *Care and Identification of 19th-Century Photographic Prints* (Kodak Publication No. G-2S, Rochester, NY: Eastman Kodak Company, 1986).
- Sabin, Alvah Horton. *House Painting*. New York: John Wiley & Sons, Inc., 1924.
- Schmidt, Carl F. *Greek Revival Details*. Scottsville: Carl F. Schmidt, 1968.

- Selden, Marjorie Ward. *The Interior Paint of the Campbell-Whittlesey House 1835-1836*. New York: The Landmark Society of Western New York, 1970.
- Seneca Falls Directories, in the collections of the Seneca Falls Historical Society:
- 1862-3 *Brigham's Geneva, Seneca Falls & Waterloo Directory & Business Advertiser for 1862 & 1862*
 - 1867-8 *Gazetteer & Business Directory of Seneca County, New York, for 1867-8*
 - 1874-5 *Seneca Falls & Waterloo Village Directory 1874-5*
 - 1881-2 *Seneca County 1881-2 Directory*
 - 1888 *Parsons' Seneca Falls & Waterloo Directory 1888*
 - 1890 *Boyd's Directory of Seneca Falls & Waterloo, 1890*
 - 1894-5 *Reference Business Directory of Seneca County, New York, 1894-'95*.
- Sonn, Albert H. *Early American Wrought Iron*. New York: Bonanza Books, 1979 (reprint of the 1928 edition published by Charles Scribner's Sons).
- Stanton, Elizabeth Cady. *Eighty Years and More: Reminiscences 1815-1897*. Reprinted in 1971 from the T. Fisher Unwin edition of 1898. New York: Schocken Books, 1971.
- "Home Life." Lyceum speech, ca. 1880. Manuscript, Douglas College Library, Rutgers University.
- Stanton, Elizabeth Cady and Henry B. "The Papers of Elizabeth Cady Stanton," 7 vols. (5 microfilm reels). The Library of Congress and Lamont Library, Harvard University.
- Stanton, Gerrit Smith. "How Aged Housekeeper Gave Her All to Cause of Woman's Suffrage." Circa-1930s news article in the archives of the Seneca Falls Historical Society.
- Stowell, Henry. *A History of Seneca Falls, New York (1779-1862)*. Reprinted from *Brigham's—1862—Geneva, Seneca Falls & Waterloo Directory* by the Seneca Falls Historical Society, 1975.
- Streeter, Donald. "Early American Wrought Iron Hardware: Norfolk Latches." *Bulletin of the Association for Preservation Technology*, Vol. III, No. 4, 1971.
- Study of Alternatives, Women's Rights Historic Sites, New York*. National Park Service, October 1979.
- Tallman, Carl C. "Early Wood-Built Houses of Central New York." *The White Pines Series of Architectural Monographs*, Vol. IV, No. 5. New York: Russell F. Whitehead, October 1918.

- Trowbridge, Alexander B. "The Greek Revival in Owego and Nearby New York Towns and Some Suggested Antidotes." *The White Pine Series of Architectural Monographs*, Vol. VIII, No. 3. New York: Russell F. Whitehead, October 1918.
- Von Rosensteil, Helene. *American Rugs & Carpets: From the Seventeenth Century to Modern Times*. New York: William Morrow & Co., Inc., 1978.
- Weber, Sandra S. *Special History Study: Women's Rights National Historical Park*. National Park Service, September 1985.
- Welch, Edgar L. "*Grip's*" *Historical Souvenir of Seneca Falls, New York*. Syracuse, NY: 1904.
- Wellman, Judith. "Elizabeth Cady Stanton's House: Some Thoughts." Typescript, Women's Rights NHP, September 1982.
- Wetmore, Mrs. S.A. "An Old-Time Lawsuit." *Seneca Falls Historical Society Papers, 1911-12*.
- , "The Bayard Family." *Seneca Falls Historical Society Papers, 1911-12*.
- Yates, Raymond F. and Marguerite W. *A Guide to Victorian Antiques*. New York: Harper & Brothers, 1949.

MAPS AND PHOTOGRAPHS

Maps in the collections of the Seneca Falls Historical Society:

- 1815 "Plan of the Village of Seneca Falls--Laid Out for W. Mynderse & Co. by F. Geddes Esq., Aug 26th 1815"
- 1825 "Map of the Village, Seneca Falls"
- 1836 "Map of the Village of Seneca Falls for V.B. Ryerson by John Burton, Surveyor, Drawn about Sept. 1836"
- 1852 Plat Book of Topographical Maps; Seneca County, N.Y.
- 1853 "Auction Sale of 42 Acres of Land in Lots Situate in the Village of Seneca Falls, N.Y.," by G. Wilcoxon
- 1856 Cadastral Wall Map by J.H. French
- 1871 "Map of the Village of Seneca Falls," by W.W. Richie, Philadelphia
- 1873 "Bird's Eye View of Seneca Falls, N.Y. 1873" by Parsons & Atwater
- 1874 *Atlas of Seneca County, New York*. Philadelphia: Pomeroy, Whitman & Co., 1874
- 1881 Sanborn Maps of Seneca Falls
- 1886 Sanborn Maps of Seneca Falls
- 1896 [title?]
- 1911 Sanborn Maps of Seneca Falls
- 1925 Sanborn Maps of Seneca Falls (corrected to 1955)

Photographs of the Stanton House, in the collections of the Seneca Falls Historical Society

DEEDS, TAX, AND CENSUS RECORDS

Seneca County Deeds and Mortgages (Seneca County Courthouse, Waterloo)

<u>1809</u>	Deed Book D, p. 457	<u>1866</u>	Deed Book 72, p. 483
<u>1831</u>	Deed Book X, p. 421	<u>1866</u>	Deed Book 76, pp. 144-45
<u>1833</u>	Deed Book Z, p. 150	<u>1867</u>	Deed Book 76, p. 66
<u>1838</u>	Deed Book R, p.	<u>1867</u>	Deed Book 77, p. 23
<u>1844</u>	Deed Book P-2, p. 225	<u>1870</u>	Deed Book 92, p. 413
<u>1844</u>	Deed Book W-2, p. 594	<u>1890</u>	Deed Book 108, p. 23
<u>1845</u>	Deed Book 58, p. 129	<u>1900</u>	Deed Book 120, p. 158
<u>1847</u>	Deed Book 52, p. 479	<u>1943</u>	Deed Book 187, p. 164
<u>1852</u>	Deed Book D-2, p. 51	<u>1945</u>	Deed Book 190, p. 467
<u>1856</u>	Deed Book 58, pp. 32-33	<u>1978</u>	Deed Book 380, p. 542
<u>1856</u>	Deed Book 58, pp. 131 & 134	<u>1982</u>	
<u>1862</u>	Deed Book 65, p. 270	<u>1982</u>	

Seneca County U.S. Pendens: 1831-1857 (Seneca County Courthouse, Waterloo)

1841 Filed August 24, p. 158

1842 Filed June 21, p. 159

Seneca Falls Tax Assessment Records
(Waterloo)

Stanton	1851	\$1,500
1854	\$1,500	
1860-62	\$1,500	
Edwards	1863	\$1,500
Boardman	1890	\$ 800
1894	\$ 800	
1897-8	\$ 750	
1899	\$ 600	
1900	\$ 600	
Gilmore	1901	\$ 400
1902-3	\$ 600	
1904-8	\$ 700	
1909-10	\$ 800	
1911-18	\$ 850	
1919	\$ 900	
1942	\$1,100	

U.S. Federal Census Records
(National Archives)

<u>1810</u>	Seneca County, Junius--microfilm reel M252, #36
<u>1820</u>	Seneca County, Junius--microfilm reel M33, #75
<u>1820</u>	Albany County, Albany--microfilm reel M33, #63
<u>1830</u>	Seneca County, Seneca Falls--microfilm reel M19, #109
<u>1830</u>	Albany County, Albany--microfilm reel M19, #84
<u>1830</u>	Wayne County, Palmyra--microfilm reel M19, #117
<u>1840</u>	Seneca County, Seneca Falls--microfilm reel M704, #339
<u>1850</u>	Seneca County, Seneca Falls--microfilm reel M432, #597
<u>1860</u>	Seneca County, Seneca Falls--microfilm reel M653, #861

Other Sources

Consultation between Richard Nylander, Society for the Preservation of New England Antiquities, and Barbara Pearson, February 1, 1983, about the Stanton House wallpapers.

